



US00D767485S

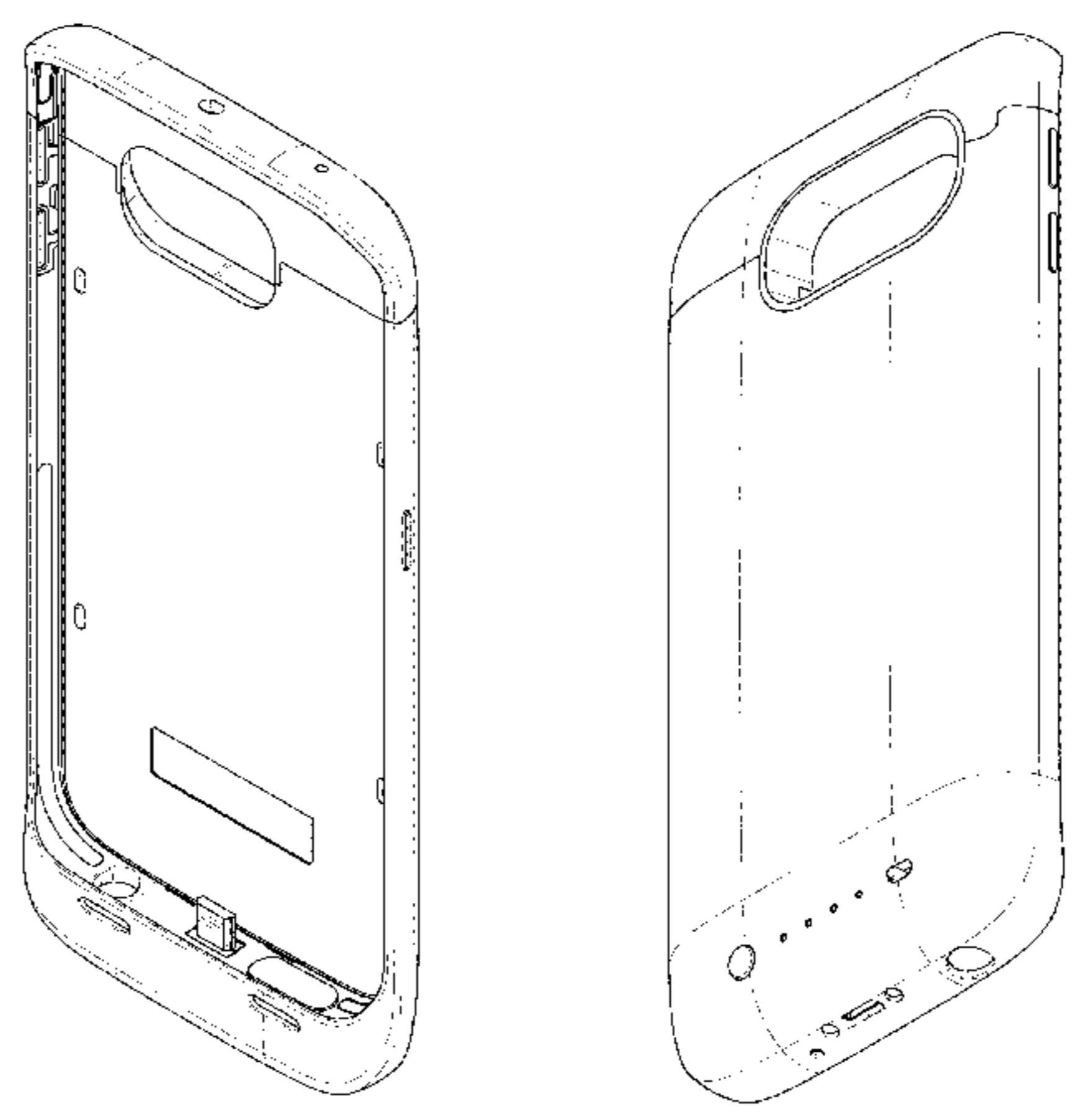
(12) **United States Design Patent** (10) **Patent No.:** **US D767,485 S**  
**To et al.** (45) **Date of Patent:** **\*\* Sep. 27, 2016**

(54) **BATTERY CASE**  
 (71) Applicant: **Mophie, Inc.**, Tustin, CA (US)  
 (72) Inventors: **Nguyen To**, Corona, CA (US); **Ming Chiao Chiang**, Alhambra, CA (US); **Denny Tsai**, Temple City, CA (US); **Fanpeng Zeng**, Shenzhen (CN)  
 (73) Assignee: **mophie, inc.**, Tustin, CA (US)  
 (\*\*) Term: **14 Years**  
 (21) Appl. No.: **29/523,211**  
 (22) Filed: **Apr. 7, 2015**  
 (51) **LOC (10) Cl.** ..... **13-02**  
 (52) **U.S. Cl.**  
 USPC ..... **D13/103; D13/108; D14/250**  
 (58) **Field of Classification Search**  
 USPC ..... D3/201, 218, 269, 301, 273, 303;  
 D14/203.3-203.8, 217, 248, 250-253,  
 D14/432, 434, 440, 450, 496, 240;  
 D13/102-106, 110, 118, 119, 184,  
 D13/199; 429/96-100, 163, 176, 177, 149,  
 429/159, 186; 206/703-705, 461-463, 471,  
 206/485, 485.1, 493; 379/426,  
 379/433.11-433.13, 455; 320/101, 102,  
 320/107-109, 110-115, 120; 361/679.56;  
 455/575.1, 575.8; 441/74; D21/769  
 CPC ... Y02E 60/12; Y02E 60/122; Y02E 60/124;  
 Y02E 60/50; H01M 10/4257; H01M  
 10/0436; H01M 10/48; H01M 2/02; H01M  
 2/022; H01M 2/0202; H01M 2/0207; H01M  
 2/0212; H01M 2/1061; H01M 2/1022;  
 H01M 2/1055; H01M 2/1066; H01M 2/105;  
 H01M 2/204  
 See application file for complete search history.

5,001,772 A 3/1991 Holcomb et al.  
 D322,719 S 12/1991 Jayez  
 D327,868 S 7/1992 Oka  
 5,360,108 A 11/1994 Alagia  
 5,368,159 A 11/1994 Doria  
 5,383,091 A 1/1995 Snell  
 5,386,084 A 1/1995 Risko  
 5,508,123 A 4/1996 Fan  
 D372,896 S 8/1996 Nagele et al.  
 5,586,002 A 12/1996 Notarianni  
 5,604,050 A 2/1997 Brunette et al.  
 5,610,979 A 3/1997 Yu  
 D384,327 S 9/1997 Nakui  
 5,708,707 A 1/1998 Halttunen et al.  
 5,711,013 A 1/1998 Collett et al.  
 D392,248 S 3/1998 Johansson  
 D392,939 S 3/1998 Finke-Anlauff  
 5,786,106 A 7/1998 Armani  
 5,816,459 A 10/1998 Armistead  
 D400,495 S 11/1998 Deslyper et al.  
 D400,496 S 11/1998 Barber et al.  
 5,859,481 A 1/1999 Banyas  
 5,864,766 A 1/1999 Chiang  
 D405,801 S 2/1999 Nagele et al.  
 D407,063 S 3/1999 Reis et al.  
 5,876,351 A 3/1999 Rohde  
 D407,708 S 4/1999 Nagele et al.  
 5,896,277 A 4/1999 Leon et al.  
 5,959,433 A 9/1999 Rohde  
 5,973,477 A 10/1999 Chang  
 D417,189 S 11/1999 Amero, Jr. et al.  
 6,043,626 A 3/2000 Snyder et al.  
 D424,512 S 5/2000 Ho  
 6,081,595 A 6/2000 Picaud  
 D428,019 S 7/2000 Amron  
 6,082,535 A 7/2000 Mitchell  
 6,171,138 B1 1/2001 Lefebvre et al.  
 D438,004 S 2/2001 Watson et al.  
 6,184,654 B1 2/2001 Bachner, III et al.  
 D439,218 S 3/2001 Yu  
 6,201,867 B1 3/2001 Koike  
 6,208,115 B1 3/2001 Binder  
 6,266,539 B1 7/2001 Pardo  
 D446,497 S 8/2001 Yu  
 6,273,252 B1 8/2001 Mitchell  
 D447,462 S 9/2001 Kosiba  
 6,313,982 B1 11/2001 Hino  
 6,317,313 B1 11/2001 Mosgrove et al.  
 6,324,380 B1 11/2001 Kiuchi et al.  
 6,346,791 B1 2/2002 Berguirdjian  
 6,405,056 B1 6/2002 Altschul et al.  
 D460,411 S 7/2002 Wang  
 D460,761 S 7/2002 Croley

(56) **References Cited**  
 U.S. PATENT DOCUMENTS

D267,795 S 2/1983 Mallon  
 4,479,596 A 10/1984 Swanson  
 4,515,272 A 5/1985 Newhouse  
 D284,372 S 6/1986 Carpenter  
 4,951,817 A 8/1990 Barletta et al.  
 D312,534 S 12/1990 Nelson et al.



# US D767,485 S

Page 2

6,415,138 B2	7/2002	Sirola et al.	D560,229 S	1/2008	Yagi
6,445,577 B1	9/2002	Madsen et al.	D561,092 S	2/2008	Kim
6,471,056 B1	10/2002	Tzeng	7,336,973 B2	2/2008	Goldthwaite et al.
D469,427 S	1/2003	Ma et al.	D563,093 S	3/2008	Nussberger
6,536,589 B2	3/2003	Chang	7,343,184 B2	3/2008	Rostami
6,538,413 B1	3/2003	Beard et al.	D565,291 S	4/2008	Brandenburg et al.
D472,384 S	4/2003	Richardson	7,397,658 B2	7/2008	Finke-Anlauff et al.
6,552,513 B1	4/2003	Li	7,400,917 B2	7/2008	Wood et al.
6,555,990 B1	4/2003	Yang	D574,326 S	8/2008	Lim
6,583,601 B2	6/2003	Simoes et al.	D574,819 S	8/2008	Andre et al.
6,614,722 B2	9/2003	Polany et al.	D575,056 S	8/2008	Tan
6,626,362 B1	9/2003	Steiner et al.	7,428,427 B2	9/2008	Brunstrom et al.
D481,716 S	11/2003	He et al.	D577,904 S	10/2008	Sasaki
D482,529 S	11/2003	Hardigg et al.	D581,151 S	11/2008	Aipa
6,646,864 B2	11/2003	Richardson	D581,155 S	11/2008	Richardson et al.
D484,874 S	1/2004	Chang et al.	D581,421 S	11/2008	Richardson et al.
D485,834 S	1/2004	Davetas	D582,149 S	12/2008	Tan
6,681,003 B2	1/2004	Linder et al.	7,464,814 B2	12/2008	Carnevali
6,701,159 B1	3/2004	Powell	D584,732 S	1/2009	Cho et al.
6,708,887 B1	3/2004	Garrett et al.	7,479,759 B2	1/2009	Vilanov et al.
6,714,802 B1	3/2004	Barvesten	D587,008 S	2/2009	Richardson et al.
6,785,566 B1	8/2004	Irizarry	D587,896 S	3/2009	Aipa
6,819,549 B1	11/2004	Lammers-Meis et al.	D589,016 S	3/2009	Richardson et al.
D500,041 S	12/2004	Tsujimoto	7,536,099 B2	5/2009	Dalby et al.
D506,612 S	6/2005	Rosa et al.	D593,319 S	6/2009	Richardson et al.
D508,495 S	8/2005	Bone et al.	D593,746 S	6/2009	Richardson et al.
D513,123 S	12/2005	Richardson et al.	D594,849 S	6/2009	Ko
6,980,777 B2	12/2005	Shepherd et al.	7,555,325 B2	6/2009	Goros
D513,451 S	1/2006	Richardson et al.	D597,089 S	7/2009	Khan et al.
6,992,461 B2	1/2006	Liang et al.	7,562,813 B2	7/2009	Humphrey et al.
D514,808 S	2/2006	Morine et al.	D597,301 S	8/2009	Richardson et al.
D516,309 S	3/2006	Richardson et al.	D598,407 S	8/2009	Richardson et al.
D516,553 S	3/2006	Richardson et al.	7,577,462 B2	8/2009	Kumar
D516,554 S	3/2006	Richardson et al.	D600,640 S	9/2009	Stein et al.
D516,807 S	3/2006	Richardson et al.	D600,908 S	9/2009	Richardson et al.
D517,007 S	3/2006	Yong-Jian et al.	D601,955 S	10/2009	Ekmekdje
D520,744 S	5/2006	Pangrec et al.	D601,959 S	10/2009	Lee et al.
7,050,841 B1	5/2006	Onda	D601,960 S	10/2009	Dai
7,069,063 B2	6/2006	Halkosaari et al.	7,609,512 B2	10/2009	Richardson et al.
D525,582 S	7/2006	Chan	D603,602 S	11/2009	Richardson et al.
7,072,699 B2	7/2006	Eiden	D603,603 S	11/2009	Laine et al.
7,079,879 B1	7/2006	Sylvester et al.	7,612,997 B1	11/2009	Diebel et al.
7,081,736 B2	7/2006	Seil et al.	D605,850 S	12/2009	Richardson et al.
D526,780 S	8/2006	Richardson et al.	D606,528 S	12/2009	Khan et al.
D526,958 S	8/2006	Shimizu	D606,529 S	12/2009	Ferrari et al.
D530,079 S	10/2006	Thomas et al.	7,635,086 B2	12/2009	Spencer, II
D535,252 S	1/2007	Sandnes	7,638,969 B2	12/2009	Woud
7,158,376 B2	1/2007	Richardson et al.	7,647,082 B2	1/2010	Holmberg
7,166,987 B2	1/2007	Lee et al.	D609,228 S	2/2010	Ferrari et al.
D537,063 S	2/2007	Kim et al.	D609,463 S	2/2010	Bullen
7,180,735 B2	2/2007	Thomas et al.	D610,538 S	2/2010	Wu et al.
7,180,754 B2	2/2007	Qin et al.	7,656,120 B2	2/2010	Neu et al.
7,194,291 B2	3/2007	Peng	7,663,878 B2	2/2010	Swan et al.
D540,539 S	4/2007	Gutierrez	7,667,433 B1	2/2010	Smith
7,203,467 B2	4/2007	Siddiqui	D610,807 S	3/2010	Bau
D542,286 S	5/2007	Taniyama et al.	D611,042 S	3/2010	Ferrari et al.
D542,524 S	5/2007	Richardson et al.	D611,478 S	3/2010	Richardson et al.
D543,541 S	5/2007	Chung et al.	7,669,829 B2	3/2010	Ogatsu
D544,486 S	6/2007	Hussaini et al.	D613,282 S	4/2010	Richardson et al.
7,230,823 B2	6/2007	Richardson et al.	D615,077 S	5/2010	Richardson et al.
D547,056 S	7/2007	Griffin et al.	D615,535 S	5/2010	Richardson et al.
D547,057 S	7/2007	Griffin et al.	D615,536 S	5/2010	Richardson et al.
D550,455 S	9/2007	Barnhart	D615,967 S	5/2010	Richardson et al.
D551,252 S	9/2007	Andre et al.	D616,360 S	5/2010	Huang
7,266,391 B2	9/2007	Warren	D616,361 S	5/2010	Huang
D551,856 S	10/2007	Ko et al.	D617,753 S	6/2010	Cheng
D553,857 S	10/2007	Pendergraph et al.	D617,784 S	6/2010	Richardson et al.
D556,679 S	12/2007	Weinstein et al.	D617,785 S	6/2010	Richardson et al.
D556,681 S	12/2007	Kim	D617,786 S	6/2010	Richardson et al.
D557,205 S	12/2007	Kim	D617,787 S	6/2010	Richardson et al.
D557,264 S	12/2007	Richardson et al.	D618,231 S	6/2010	Fahrendorff et al.
D557,494 S	12/2007	Mayette et al.	7,733,637 B1	6/2010	Lam
D557,897 S	12/2007	Richardson et al.	D619,573 S	7/2010	Khan et al.
7,312,984 B2	12/2007	Richardson et al.	D619,574 S	7/2010	Richardson et al.
D558,667 S	1/2008	Park et al.	D619,991 S	7/2010	Huang
D558,757 S	1/2008	Andre et al.	D620,000 S	7/2010	Bau
D558,972 S	1/2008	Oh	D620,487 S	7/2010	Richardson et al.
D558,973 S	1/2008	Hussaini et al.	D621,394 S	8/2010	Richardson et al.
D559,267 S	1/2008	Griffin	D621,395 S	8/2010	Richardson et al.

# US D767,485 S

D621,821 S	8/2010	Richardson et al.	8,046,039 B2	10/2011	Lee et al.
D621,822 S	8/2010	Richardson et al.	D648,714 S	11/2011	Jones, III et al.
7,778,023 B1	8/2010	Mohoney	D648,715 S	11/2011	Jones, III et al.
7,782,610 B2	8/2010	Diebel et al.	D648,716 S	11/2011	Jones, III et al.
D623,179 S	9/2010	Richardson et al.	D648,717 S	11/2011	Fahrendorff et al.
D623,180 S	9/2010	Diebel	D649,143 S	11/2011	Jones, III et al.
D623,638 S	9/2010	Richardson et al.	D649,539 S	11/2011	Hong
D623,639 S	9/2010	Richardson et al.	D650,810 S	12/2011	Lemelman et al.
D623,640 S *	9/2010	Freeman ..... D14/250	D652,827 S	1/2012	Fahrendorff et al.
D624,317 S	9/2010	Wenchel et al.	D652,828 S	1/2012	Fahrendorff et al.
D624,533 S	9/2010	Richardson et al.	D653,202 S *	1/2012	Hasbrook ..... D13/103
D624,908 S	10/2010	Huskinson	D653,659 S	2/2012	Fahrendorff et al.
D624,909 S	10/2010	Huskinson	D654,069 S	2/2012	Kwon
D624,910 S	10/2010	Richardson et al.	D654,483 S	2/2012	Richardson et al.
D625,303 S	10/2010	Kim	D654,931 S	2/2012	Lemelman et al.
D626,120 S	10/2010	Richardson et al.	D655,281 S	3/2012	Turocy
D626,121 S	10/2010	Richardson et al.	D655,699 S	3/2012	Bau
D626,538 S	11/2010	Brown et al.	D656,495 S	3/2012	Andre et al.
D626,539 S	11/2010	Brown et al.	D658,165 S	4/2012	Freeman
D626,540 S	11/2010	Brown et al.	8,150,485 B2	4/2012	Lee
D626,964 S	11/2010	Richardson et al.	D658,643 S	5/2012	Fahrendorff et al.
D628,568 S	12/2010	Richardson et al.	8,167,127 B2	5/2012	Martin et al.
D628,994 S	12/2010	Griffin, Jr. et al.	D662,923 S	7/2012	Piedra et al.
7,859,222 B2	12/2010	Woud	D663,263 S *	7/2012	Gupta ..... D13/103
D631,246 S	1/2011	Boettner	D663,319 S	7/2012	Chen et al.
7,863,856 B2	1/2011	Sherman et al.	D664,091 S	7/2012	Pliner et al.
7,863,862 B2	1/2011	Idzik et al.	8,224,408 B2	7/2012	Tomasini et al.
D631,877 S	2/2011	Rak et al.	D665,386 S	8/2012	Fathollahi
D632,648 S	2/2011	Yang	D665,735 S *	8/2012	Kang ..... D13/108
D632,683 S	2/2011	Richardson et al.	8,245,842 B2	8/2012	Bau
D632,684 S	2/2011	Richardson et al.	8,247,102 B2	8/2012	Hua
D632,685 S	2/2011	Richardson et al.	D667,783 S *	9/2012	Zhang ..... D13/102
D632,686 S	2/2011	Magness et al.	D670,281 S *	11/2012	Corpuz ..... D14/250
7,889,489 B2	2/2011	Richardson et al.	D670,689 S	11/2012	Wang
7,889,498 B2	2/2011	Diebel et al.	D671,105 S	11/2012	Rothbaum et al.
D634,704 S	3/2011	Tieleman et al.	D671,106 S	11/2012	Rothbaum et al.
D634,741 S	3/2011	Richardson et al.	D671,493 S *	11/2012	Hasbrook ..... D13/108
7,899,397 B2	3/2011	Kumar	8,321,619 B2	11/2012	Kular et al.
7,907,394 B2	3/2011	Richardson et al.	8,328,008 B2	12/2012	Diebel et al.
7,911,530 B2	3/2011	Sawachi	D674,394 S	1/2013	Kajimoto
D636,386 S	4/2011	Richardson et al.	D675,603 S	2/2013	Melanson et al.
D636,387 S	4/2011	Willes et al.	D676,032 S	2/2013	Stump et al.
7,930,011 B2	4/2011	Shi et al.	D676,432 S	2/2013	Hasbrook et al.
7,933,122 B2	4/2011	Richardson et al.	8,367,235 B2	2/2013	Huang
D637,588 S	5/2011	Richardson et al.	8,380,264 B2	2/2013	Hung et al.
D637,589 S	5/2011	Willes et al.	D677,249 S *	3/2013	Li ..... D14/250
D637,590 S	5/2011	Michie et al.	D678,869 S	3/2013	Diebel
D637,591 S	5/2011	Willes et al.	8,393,466 B2	3/2013	Rayner
D637,592 S	5/2011	Magness et al.	D679,271 S	4/2013	Liu
D637,952 S	5/2011	Tan	D679,684 S	4/2013	Baker et al.
D638,005 S	5/2011	Richardson et al.	D681,020 S	4/2013	Magness et al.
D638,411 S	5/2011	Willes et al.	D682,196 S	5/2013	Leung
D638,413 S	5/2011	Magness et al.	D682,815 S	5/2013	Chang
D638,414 S	5/2011	Magness et al.	D683,338 S	5/2013	Wilson et al.
D638,828 S	5/2011	Melanson et al.	8,439,191 B1	5/2013	Lu
D638,829 S	5/2011	Melanson et al.	8,452,242 B2	5/2013	Spencer, II
D638,830 S	5/2011	Magness et al.	8,457,701 B2	6/2013	Diebel
D639,731 S	6/2011	Sun	D685,356 S	7/2013	Diebel
D640,679 S	6/2011	Willes et al.	D686,152 S	7/2013	Lee et al.
D640,680 S	6/2011	Magness et al.	D686,606 S	7/2013	Hong
7,957,524 B2	6/2011	Chipping	8,483,758 B2 *	7/2013	Huang ..... H04B 1/3883 361/679.41
D641,013 S	7/2011	Richardson et al.	D687,426 S	8/2013	Requa
D641,014 S	7/2011	Smith et al.	D688,233 S	8/2013	Dong
D641,974 S	7/2011	Stampfli	8,499,933 B2	8/2013	Ziemba
D642,170 S	7/2011	Johnson et al.	8,505,718 B2	8/2013	Griffin, Jr. et al.
D642,171 S	7/2011	Melanson et al.	8,509,864 B1	8/2013	Diebel
D642,558 S	8/2011	Magness	8,509,865 B1	8/2013	LaColla et al.
D643,029 S	8/2011	Feng	8,531,833 B2	9/2013	Diebel et al.
D643,424 S	8/2011	Richardson et al.	D691,990 S	10/2013	Rayner
D644,215 S	8/2011	Dong	8,560,014 B1	10/2013	Hu et al.
D644,216 S	8/2011	Richardson et al.	D693,801 S	11/2013	Rayner
D644,219 S	8/2011	Sawada	8,579,172 B2	11/2013	Monaco et al.
7,988,010 B2	8/2011	Yang et al.	D696,234 S	12/2013	Wright
8,004,962 B2	8/2011	Yang et al.	D697,502 S	1/2014	Chu et al.
D644,635 S	9/2011	Richardson et al.	D698,774 S	2/2014	Wardy
D644,639 S	9/2011	Weller et al.	D703,652 S	4/2014	Melanson et al.
D647,084 S	10/2011	Fathollahi	D704,182 S	5/2014	Smith
D647,108 S	10/2011	Lee	D704,688 S	5/2014	Reivo et al.
8,028,794 B1	10/2011	Freeman			



2013/0125251	A1	5/2013	Johnson	
2013/0189923	A1	7/2013	Lewin	
2013/0273983	A1	10/2013	Hsu	
2013/0314030	A1*	11/2013	Fathollahi .....	H02J 7/0045 320/107
2013/0314880	A1	11/2013	Sun et al.	
2014/0069825	A1	3/2014	Macrina et al.	
2014/0165379	A1	6/2014	Diebel et al.	
2014/0239916	A1*	8/2014	To .....	H02J 7/0042 320/137
2014/0375182	A1*	12/2014	Li .....	G06F 1/1679 312/223.1
2015/0010806	A1	1/2015	Huang et al.	
2015/0072200	A1	3/2015	Huang	
2015/0072744	A1	3/2015	Huang	
2015/0084593	A1	3/2015	Huang et al.	
2015/0093623	A1	4/2015	Huang et al.	
2015/0140386	A1	5/2015	Huang et al.	
2015/0148093	A1	5/2015	Huang et al.	
2015/0281410	A1*	10/2015	Takahashi .....	H04M 1/02 455/575.1
2015/0381226	A1*	12/2015	Mogol .....	H04B 1/3888 455/575.1
2016/0043764	A1*	2/2016	Huang .....	H01M 10/46 455/575.8

FOREIGN PATENT DOCUMENTS

CN	201252577	Y	6/2009
CN	202364273	U	8/2012
CN	202535667	U	11/2012
CN	302510329	S	7/2013
CN	302573150	S	9/2013
EP	1732291	A1	12/2006
JP	8-18637		1/1996
JP	2000-175720		6/2000
KR	10-2005-0027961		3/2005
KR	10-2008-0017688		2/2008
KR	20-2010-0005030		5/2010
KR	10-2010-0132724		12/2010
KR	10-2011-0005507		1/2011
KR	30-0650361		7/2012
TW	D150044		11/2012
TW	D156538		10/2013
WO	WO 95/15619		6/1995
WO	WO 97/33497		9/1997
WO	WO 03/065227	A1	8/2003
WO	WO 2008/151362	A2	12/2008

OTHER PUBLICATIONS

Amazon.com: Galaxy S6 Battery Case, i-Blason External Protective Battery Case / Cover for Samsung Galaxy S6 2015 Release. Customer review published Mar. 29, 2015. Retrieved from internet at <<http://www.amazon.com/Case-i-Blason-External-Protective-Versions/dp/B00SN4LME>>, Apr. 28, 2016. 7 pages.\*

Reexamination Control No. 90/013,319 including its prosecution history, Sep. 18, 2014, filing date, Huang et al.

U.S. Appl. No. 14/749,300 including its prosecution history, filed Jun. 24, 2015, Huang et al.

U.S. Appl. No. 14/800,530 including its prosecution history, filed Jul. 15, 2015, Huang.

U.S. Appl. No. 14/679,899 including its prosecution history, filed Apr. 6, 2015, Huang.

U.S. Appl. No. 14/187,046 including its prosecution history, filed Feb. 21, 2014, To et al.

U.S. Appl. No. 14/205,024 including its prosecution history, filed Mar. 11, 2014, Huang et al.

U.S. Appl. No. 14/205,167 including its prosecution history, filed Mar. 11, 2014, Huang et al.

U.S. Appl. No. 29/382,515 including its prosecution history, filed Jan. 4, 2011, Gallouzi et al.

U.S. Appl. No. 29/406,346 including its prosecution history, filed Nov. 11, 2011, Brand.

U.S. Appl. No. 29/464,620 including its prosecution history, filed Aug. 19, 2013, Tsai.

U.S. Appl. No. 29/438,697 including its prosecution history, filed Nov. 30, 2012, Namminga et al.

U.S. Appl. No. 29/451,703 including its prosecution history, filed Apr. 6, 2013, Tsai et al.

U.S. Appl. No. 29/435,907 including its prosecution history, filed Oct. 30, 2012, To et al.

U.S. Appl. No. 29/438,877 including its prosecution history, filed Dec. 4, 2012, To et al.

U.S. Appl. No. 29/440,062 including its prosecution history, filed Dec. 18, 2012, To et al.

U.S. Appl. No. 29/478,391 including its prosecution history, filed Jan. 3, 2014, Namminga et al.

U.S. Appl. No. 29/478,390 including its prosecution history, filed Jan. 3, 2014, Dang et al.

U.S. Appl. No. 29/478,383 including its prosecution history, filed Jan. 3, 2014, Dang et al.

U.S. Appl. No. 29/478,388 including its prosecution history, filed Jan. 3, 2014, Kim et al.

U.S. Appl. No. 14/467,067 including its prosecution history, filed Mar. 31, 2015, To et al.

U.S. Appl. No. 29/499,868 including its prosecution history, filed Aug. 19, 2014, Mophie, Inc.

U.S. Appl. No. 29/510,154 including its prosecution history, filed Nov. 25, 2014, Mophie, Inc.

U.S. Appl. No. 29/510,153 including its prosecution history, filed Nov. 25, 2014, Mophie, Inc.

U.S. Appl. No. 29/522,987 including its prosecution history, filed Apr. 6, 2015, Gjøvik et al.

U.S. Appl. No. 29/510,839 including its prosecution history, filed Dec. 3, 2014, Mophie, Inc.

U.S. Appl. No. 29/523,209 including its prosecution history, filed Apr. 7, 2015, Mophie, Inc.

U.S. Appl. No. 29/528,266 including its prosecution history, filed May 27, 2015, Gjøvik et al.

International Search Report and Written Opinion of the International Searching Authority for PCT/US2011/037244, dated Jul. 19, 2011.

International Preliminary Report on Patentability for PCT/US2011/037244, dated Nov. 29, 2012.

International Search Report and Written Opinion of the International Searching Authority for PCT/US2011/037249, dated Jul. 13, 2011.

International Preliminary Report on Patentability for PCT/US2011/037249, dated Nov. 29, 2012.

International Search Report and Written Opinion of the International Searching Authority for PCT/US2011/037254, dated Jul. 13, 2011.

International Preliminary Report on Patentability for PCT/US2011/037254, dated Nov. 29, 2012.

International Search Report and Written Opinion of the International Searching Authority for PCT/US2011/037257, dated Sep. 22, 2011.

International Preliminary Report on Patentability for PCT/US2011/037257, dated Nov. 29, 2012.

International Search Report and Written Opinion of the International Searching Authority for PCT/US2012/041768, dated Feb. 27, 2013.

International Preliminary Report on Patentability for PCT/US2012/041768, dated Dec. 27, 2013.

International Search Report and Written Opinion of the International Searching Authority for PCT/US2013/057276, dated Dec. 10, 2013.

International Preliminary Report on Patentability for PCT/US2013/057276, dated Mar. 3, 2015.

International Search Report and Written Opinion of the International Searching Authority for PCT/US2014/017781, dated Jun. 8, 2014.

International Search Report and Written Opinion of the International Searching Authority for PCT/US2014/023592, dated Aug. 28, 2014.

International Search Report and Written Opinion for PCT/US2014/067470, dated Mar. 31, 2015.

- Mophie Pulse for iPod Touch 4G, [http://www.mophie.com/pulse-iPod-Touch-4th-Gen-vibrating-gaming-case-p/2015\\_PUL-T4-GRY.htm](http://www.mophie.com/pulse-iPod-Touch-4th-Gen-vibrating-gaming-case-p/2015_PUL-T4-GRY.htm).
- “Sandberg BatteryCase for iPhone 4/4S delivers more band for your buck,” dated Mar. 15, 2012, <http://www.gizmag.com/sanberg-battery-case-iphone/21839>.
- Shawn Brown, “Incase Power Slider battery doubles as a case,” dated Nov. 19, 2008, <http://www.iphonebuzz.com/incase-power-slider-battery-doubles-as-a-case-195224.php>.
- Nick Guy, “Incipio offGRID Battery Case for iPhone 5/5s,” dated Oct. 9, 2013, <http://www.ilounge.com/index.php/reviews/entry/incipio-offgrid-battery-case-for-iphone-5-5s/>.
- Jeremy Horwitz, “Mophie Juice Pack Plus for iPhone 5,” dated May 21, 2013, <http://www.ilounge.com/index.php/reviews/entry/mophie-juice-pack-plus-for-iphone-5/>.
- Nick Guy, “RND Power Solutions Sync & Charge Dock with Lightning Connector,” dated Nov. 18, 2013, <http://www.ilounge.com/index.php/reviews/entry/tylt-energi-sl>.
- Jeremy Horwitz, “Kensington Mini Battery Pack and Charger for iPhone and iPod,” dated May 16, 2008, <http://www.ilounge.com/index.php/reviews/entry/kensington-mini-battery-pack-and-charger-for-iphone-and-ipod/>.
- Kensington Mini Battery Pack and Charger for iPhone and iPod, dated Sep. 30, 2008, 1 Page.
- Sven Rafferty, “Mybat External Battery for iPhone and iPod,” dated May 18, 2008, <http://svenontech.com/reviews/?p=74>.
- Dave Rees, “Richard Solo Backup Battery for iPhone / iPod Review,” dated Jun. 16, 2008, [http://the-gadgeteer.com/2008/06/16/richard\\_solo\\_backup\\_battery\\_for\\_iphone\\_ipod/](http://the-gadgeteer.com/2008/06/16/richard_solo_backup_battery_for_iphone_ipod/).
- Devin Coldewey, “Combination iPhone battery pack and flash from FastMac,” dated Nov. 4, 2008, <http://crunchgear.com/2008/11/04/combination-iphone-battery-pack-and-flash-from-fastmac/>.
- “Cheap DIY iPhone External Battery,” dated Jul. 22, 2008, <http://fastdad.wordpress.com/2008/07/22/cheap-diy-iphone-external-battery/>.
- Jeremy Horwitz, “iLuv i603 / i604 Rechargeable Lithium Polymer Batteries with Silicone Skin,” dated Jun. 27, 2006, <http://www.ilounge.com/index.php/reviews/entry/iluv-i603-rechargeable-lithium-polymer-battery-with-silicone-skin/>.
- Julie Strietelmeier, “Seidio INNODock Desktop Cradle for Treo 650,” dated Jul. 28, 2005, [http://the-gadgeteer.com/2005/07/28/seidio\\_innodock\\_desktop\\_cradle\\_for\\_treo\\_650/](http://the-gadgeteer.com/2005/07/28/seidio_innodock_desktop_cradle_for_treo_650/).
- Brian Nyhuis, “Mophie Juice Pack Battery Case for Samsung Galaxy S III Review,” dated Nov. 28, 2012, [http://www.legitreviews.com/mophie-juice-pack-battery-case-for-samsung-galaxy-s-iii-review\\_2084](http://www.legitreviews.com/mophie-juice-pack-battery-case-for-samsung-galaxy-s-iii-review_2084).
- “PowerSkin Samsung Galaxy S3 Case with Backup Battery,” dated Aug. 19, 2012, <http://gadgetsin.com/powerskin-samsung-galaxy-s3-cse-with-backup-battery.htm>.
- “iPhone 4 Case with Battery Pack,” dated Sep. 28, 2010, <http://gadgetsin.com/iphone-4-case-with-battery-pack.htm>.
- Jonathan Pena, “iPhone 5 Cases, Round 3,” dated Sep. 16, 2012, <http://www.technologytell.com/apple/103833/iphone-5-cases-round-3/>.
- Jeremy Horwitz, “Mophie Juice Pack for iPhone,” dated Dec. 7, 2007, <http://www.ilounge.com/index.php/reviews/entry/mophie-juice-pack-for-iphone/>.
- Dr. Macenstein, “Review: Mophie Juice Pack for iPhone,” dated Apr. 27, 2008, <http://macenstein.com/default/archives/1314>.
- Wayne Schulz, “iPhone Extended Battery Review—Mophie Juice Pack,” dated Jun. 17, 2008, <http://www.geardiary.com/2008/06/17/iphone-extended-battery-review-mophie-juice-pack/>.
- Mophie Juice Pack iPhone 1G Product—Figures 1-7—Retrieved from <http://www.mophie.com/products/juice-pack> on Apr. 10, 2009.
- Mophie Juice Pack iPhone 1G Product—Figure 8—Retrieved from <http://www.mophie.com/pages/information/> on Apr. 10, 2009.
- Mophie Juice Pack iPhone 1G Product—Figures 9-14—Retrieved from [http://www.mophie.com/blogs/Juice\\_Pack\\_FAQ](http://www.mophie.com/blogs/Juice_Pack_FAQ) on Apr. 10, 2009.
- Mophie Juice Pack iPhone 1G Product—Figures 15-16—Retrieved from [http://mophie.com/blogs/Juice\\_Pack\\_FAQ](http://mophie.com/blogs/Juice_Pack_FAQ) on Apr. 20, 2009. Figure 16 is dated May 1, 2008.
- Tomas Ratas, “Mophie Juice Pack—iPhone 3G,” dated Dec. 9, 2008, <http://www.testfreaks.com/blog/review/mophie-juice-pack-iphone-3g/>.
- Dr. Macenstein, “Review: Mophie Juice Pack 3G for iPhone,” dated Nov. 27, 2008, <http://macenstein.com/default/archives/1820>.
- Ewdison Then, “Mophie Juice Pack iPhone 3G Review,” dated Nov. 12, 2008, <http://www.slashgear.com/mophie-juice-pack-iphone-3g-review-1222446/>.
- Mophie Juice Pack iPhone 3G Product—Figures 1-8—Retrieved from <http://www.mophie.com/products/juice-pack-iphone-3g> on Apr. 10, 2009.
- Mophie Juice Pack iPhone 3G Product—Figures 9-10—Retrieved from <http://www.mophie.com/pages/iphone-3g-details> on Apr. 10, 2009.
- Mophie Juice Pack iPhone 3G Product—Figures 11-14—Retrieved from [http://mophie.com/blogs/Juice\\_Pack\\_3G\\_FAQ](http://mophie.com/blogs/Juice_Pack_3G_FAQ) on Apr. 10, 2009.
- Mophie Juice Pack iPhone 3G Product—Figures 15-16—Retrieved from <http://mophie.com/blogs/press> on Apr. 20, 2009. Figure 15 is dated Aug. 4, 2008, and Figure 16 is dated Nov. 10, 2008.
- Mophie Juice Pack iPhone 3G User Manual—Retrieved from [http://static3.shopify.com/s/files/1/0008/4942/assets/mophie\\_juice\\_pack\\_3G\\_manual\\_rl.pdf](http://static3.shopify.com/s/files/1/0008/4942/assets/mophie_juice_pack_3G_manual_rl.pdf) on Apr. 10, 2009.
- Panasonic Lithium Ion Batteries Technical Handbook, dated 2007.
- Chris Foresman, “Several Backup Batteries Can Extend Your Daily iPhone 3G Use,” dated Jul. 18, 2008, <http://arstechnica.com/apple/2008/07/several-backup-batteries-can-extend-your-daily-iphone-3g-use/>.
- Using Your Treo 650 Smartphone by palmOne, dated 2005.
- Lisa Gade, “Palm Treo 750,” dated Jan. 17, 2007, <http://www.mobiletechreview.com/phones/Treo-750.htm>.
- Incase Power Slider 3G for iPhone 3G Product Reference, alleged by Incase to be available on Nov. 28, 2008.
- iPhone User’s Guide, 2007.
- “Power Slider,” Web Archive Date Dec. 4, 2008, <https://web.archive.org/web/20081204105303/http://goincase.com/products/detail/power-slider-ec20003/>.
- Azadeh Ensha, “A Case for Filling the iPhone 3G’s Power Vacuum,” Dated Nov. 27, 2008.
- Joseph Flatley, “Incase Power Slider for iPhone 3G Doubles the Juice, Lets You Sync,” dated Nov. 17, 2008.
- Darren Quick, “Mophie Juice Pack for iPhone 3G now shipping,” dated Nov. 10, 2008, <http://www.gizmag.com/mophie-juice-pack-iphone-3g/10342/>.
- Otterbox Catalog, 2006.
- Jeremy Horowitz, “PhoneSuit MiLi Power Pack for iPhone,” Jan. 29, 2009, <http://www.ilounge.com/index.php/reviews/entry/phonesuit-mili-power-pack-for-iphone/>.
- Jeremy Horowitz, “FastMac TruePower iV Universal Battery Charger,” Dec. 11, 2008, <http://www.ilounge.com/index.php/reviews/entry/fastmac-truepower-iv-universal-battery-charger/>.
- Jeremy Horowitz, “Konnet PowerKZ Extended Power for iPhone,” Apr. 2, 2009, <http://www.ilounge.com/index.php/reviews/entry/konnet-powerkz-extended-power-for-iphone/>.
- “Test: Batterie iPhone SKPAD” with Machine English Translation, Feb. 2, 2009, <http://iphonesofa.com/2009/02/02/test-batterie-iphone-skpad>.
- Kanamori et al., “USB battery-charger designs meet new industry standards,” EDN pp. 63-70, dated Feb. 21, 2008.
- AVR458: Charging Lithium-Ion Batteries with ATAVRBC100, which appear to include a date of Aug. 2008.
- Battery Charging Specification, dated Apr. 15, 2009.
- BCM2033 Product Brief, 2 pages, dated Nov. 1, 2002.
- “USB battery charger detector intelligently powers mobiles,” Dec. 17, 2007, [http://www.eetasia.com/ART\\_8800493819\\_765245\\_NP\\_10b171b6.HTMce#](http://www.eetasia.com/ART_8800493819_765245_NP_10b171b6.HTMce#).
- Webpage Archive, Mophie.com, Nov. 25, 2007.
- Ben Kaufman, “Behind the Invention: The mophie Juice Pack,” dated Dec. 31, 2013, <https://medium.com/@benkaufman/behind-the-invention-the-mophie-juice-pack-a0620f74efcf>.
- Mophie Relo Recharge, dated Feb. 7, 2006, <http://songsling.com/recharge.html>.

*Case-Ari, LLC v. mStation, Inc.*, Case No. 1:2010-CV-01874 in the United States District Court for the Northern District of Georgia, filed Jun. 17, 2010 (Docket).

*Daniel Huang v. GC Technology, LLC*, Case No. CV10-4705 CAS (VBKx) in the United States District Court for the Central District of California, filed Jun. 24, 2010 (Docket).

*Hali-Power, Inc. v. mStation Corp.*, Case No. 1:2010-CV-00773 in the United States District Court for the Northern District of New York, filed Jun. 30, 2010 (Docket).

*Mophie, Inc. v. Loza & Loza, LLP*, Case No. SACV11-00539 DOC (MLGx) in the United States District Court for the Central District of California, filed Apr. 7, 2011 (Docket).

Mophie's Complaint, filed Apr. 7, 2011 in *Mophie, Inc. v. Loza & Loza, LLP*, Case No. SACV11-00539 DOC (MLGx) in the United States District Court for the Central District of California.

*Mophie, Inc. v. Foreign Trade Corporation*, Case No. 8:12-CV-00292-JST-RNB in the United States District Court for the Central District of California, filed Feb. 24, 2012 (Docket).

*Mophie, Inc. v. Kdlinks Inc.*, Case No. 2:2012-CV-02639 in the United States District Court for the Central District of California, filed Mar. 27, 2012 (Docket).

*Otter Products, LLC v. Mophie, LLC*, Case No. 1:2012-CV-01969 in the United States District Court for the District of Colorado, filed Jul. 27, 2012 (Docket).

Mophie's Answer, filed Oct. 15, 2012 in *Otter Products, LLC v. Mophie, LLC*, Case No. 1:2012-CV-01969 in the United States District Court for the District of Colorado.

Otter's Motion for Summary Judgment of Infringement and Declaration in Support Thereof, filed May 13, 2013 in *Otter Products, LLC v. Mophie, LLC*, Case No. 1:2012-CV-01969 in the United States District Court for the District of Colorado.

Mophie's Opposition to Motion for Summary Judgment of Infringement, filed Jun. 6, 2013 in *Otter Products, LLC v. Mophie, LLC*, Case No. 1:2012-CV-01969 in the United States District Court for the District of Colorado.

Mophie's Claim Construction Brief, filed Jun. 14, 2013 in *Otter Products, LLC v. Mophie, LLC*, Case No. 1:2012-CV-01969 in the United States District Court for the District of Colorado.

Otter's Claim Construction Brief, filed Jun. 14, 2013 in *Otter Products, LLC v. Mophie, LLC*, Case No. 1:2012-CV-01969 in the United States District Court for the District of Colorado.

Mophie's Brief in Response to Otter's Claim Construction Brief, filed Jun. 24, 2013 in *Otter Products, LLC v. Mophie, LLC*, Case No. 1:2012-CV-01969 in the United States District Court for the District of Colorado.

Otter's Rebuttal Brief for Construction of Claim Terms and Declaration, filed Jun. 24, 2013 in *Otter Products, LLC v. Mophie, LLC*, Case No. 1:2012-CV-01969 in the United States District Court for the District of Colorado.

Otter's Reply in Support of Motion for Summary Judgment of Infringement, filed Jun. 24, 2013 in *Otter Products, LLC v. Mophie, LLC*, Case No. 1:2012-CV-01969 in the United States District Court for the District of Colorado.

Joint Claim Construction Statement, filed Jun. 26, 2013 in *Otter Products, LLC v. Mophie, LLC*, Case No. 1:2012-CV-01969 in the United States District Court for the District of Colorado.

*Incase Designs, Inc. v. Mophie, Inc.*, Case No. 3:2013-CV-00602 in the United States District Court for the Northern District of California, filed Feb. 12, 2013 (Docket).

Mophie's Amended Answer and Counterclaims, filed May 8, 2013 in *Incase Designs, Inc. v. Mophie, Inc.*, Case No. 3:2013-CV-00602 in the United States District Court for the Northern District of California.

Mophie's Opposition to Motion to Strike Amended Affirmative Defenses, Filed Jun. 12, 2013 in *Incase Designs, Inc. v. Mophie, Inc.*, Case No. 3:2013-CV-00602 in the United States District Court for the Northern District of California.

Mophie's Reply in Support of Motion to Stay and Supporting Declaration, filed Sep. 3, 2103 in *Incase Designs, Inc. v. Mophie, Inc.*, Case No. 3:2013-CV-00602 in the United States District Court for the Northern District of California.

*Incase Designs, Inc. v. Mophie, Inc.*, Case No. 3:2013-CV-03356 in the United States District Court for the Northern District of California, filed Jul. 18, 2013 (Docket).

*Incase Designs, Corp. v. Mophie, Inc.*, Case No. 3:2013-CV-04314 in the United States District Court for the Northern District of California, filed Sep. 18, 2013 (Docket).

Mophie Motion 1—To Be Accorded Benefit, filed Nov. 20, 2013 in Patent Interference No. 105,946(RES).

Declaration of John Feland, Ph.D, In Support of Mophie Motion 1 to Be Accorded Benefit, dated Nov. 20, 2013, in Patent Interference No. 105,946(RES).

Mophie Motion 2—For Judgment that Incase's Involved Claims Are Unpatentable, filed Nov. 20, 2013 in Patent Interference No. 105,946(RES).

Declaration of John Feland, Ph.D, in Support of Mophie Motion 2 for Judgment That Incase's Involved Claims Are Unpatentable, dated Nov. 20, 2013, in Patent Interference No. 105,946(RES).

Incuse Motion 1—Motion for Benefit, filed Nov. 20, 2013 in Patent Interference No. 105,946(RES).

Incuse Motion 2—Motion to Undesignate Claims, filed Nov. 20, 2013 in Patent Interference No. 105,946(RES).

Incuse Motion 3—Motion for Judgment Based on Lack of Written Description, filed Nov. 20, 2013 in Patent Interference No. 105,946(RES).

Incuse Motion 4—Motion for Unpatentability of Mophie Claims, filed Nov. 20, 2013 in Patent Interference No. 105,946(RES).

Declaration of Andrew Wolfe, filed Nov. 20, 2013 in Patent Interference No. 105,946(RES).

Declaration of Thomas Overthun, filed Nov. 20, 2013 in Patent Interference No. 105,946(RES).

Declaration of Gabriel Dan, filed Nov. 20, 2013 in Patent Interference No. 105,946(RES).

Mophie's Third Amended Complaint, filed Jun. 27, 2014, in *Mophie, Inc. v. Source Vista*, Case No. 8:13-CV-01321 in the United States District Court for the Central District of California.

LivingSocial's Answer to Mophie's Fifth Amended Complaint and Counterclaims, filed Sep. 24, 2014, in *Mophie, Inc. v. Source Vista*, Case No. 8:13-CV-01321 in the United States District Court for the Central District of California.

Shah's Answer, Affirmative Defenses, and Counterclaims to Plaintiff's Fifth Amended Complaint, filed Sep. 24, 2014, in *Mophie, Inc. v. Source Vista*, Case No. 8:13-CV-01321 in the United States District Court for the Central District of California.

Expert Report of Dr. David Munson, dated Aug. 28, 2014, in *Mophie, Inc. v. Source Vista*, Case No. 8:13-CV-01321 in the United States District Court for the Central District of California.

Expert Report of John Feland, Ph.D, dated Aug. 28, 2014, in *Mophie, Inc. v. Source Vista*, Case No. 8:13-CV-01321 in the United States District Court for the Central District of California.

Rebutal Expert Report of John Feland, Ph.D, dated Sep. 25, 2014, in *Mophie, Inc. v. Source Vista*, Case No. 8:13-CV-01321 in the United States District Court for the Central District of California.

Rebutal Expert Report of Dr. David Munson, dated Sep. 25, 2014, in *Mophie, Inc. v. Source Vista*, Case No. 8:13-CV-01321 in the United States District Court for the Central District of California.

Mophie's Second Amended Response to LivingSocial's Interrogatory No. 1[21], dated Aug. 28, 2014, in *Mophie, Inc. v. Source Vista*, Case No. 8:13-CV-01321 in the United States District Court for the Central District of California.

Mophie's Second Amended Response to Serve Global's Interrogatory No. 2, dated Aug. 28, 2014, in *Mophie, Inc. v. Source Vista*, Case No. 8:13-CV-01321 in the United States District Court for the Central District of California.

Defendant's Memorandum in Support of Motion for Partial Summary Judgement, dated Sep. 23, 2014, in *Mophie, Inc. v. Source Vista*, Case No. 8:13-CV-01321 in the United States District Court for the Central District of California.

Declaration of David Munson in Support of Defendant's Motion for Partial Summary Judgment, dated Sep. 22, 2014, in *Mophie, Inc. v. Source Vista*, Case No. 8:13-CV-01321 in the United States District Court for the Central District of California.

John Feland, Ph.D. Deposition Transcript, dated Sep. 30, 2014, in *Mophie, Inc. v. Source Vista*, Case No. 8:13-CV-01321 in the United States District Court for the Central District of California.

Matthew Brand Deposition Transcript, dated Jul. 23, 2014, in *Mophie, Inc. v. Source Vista*, Case No. 8:13-CV-01321 in the United States District Court for the Central District of California.

Dharmesh Shah Deposition Transcript, dated Jul. 11, 2014, in *Mophie, Inc. v. Source Vista*, Case No. 8:13-CV-01321 in the United States District Court for the Central District of California.

Defendants' Statement of Uncontroverted Material Fact and Contentions of Law, filed Sep. 22, 2014 in *Mophie, Inc. v. Source Vista*, Case No. 8:13-CV-01321 in the United States District Court for the Central District of California.

Memorandum of Points and Authorities in Support of Mophie's Motion for Summary Judgment, filed Sep. 22, 2014, in *Mophie, Inc. v. Source Vista*, Case No. 8:13-CV-01321 in the United States District Court for the Central District of California.

Statement of Uncontroverted Facts and Conclusions of Law in Support of Mophie's Motion for Summary Judgment, filed Sep. 22, 2014, in *Mophie, Inc. v. Source Vista*, Case No. 8:13-CV-01321 in the United States District Court for the Central District of California.

Mophie's Opposition to Shah and Serve Global's Motion for Partial Summary Judgment, dated Oct. 3, 2014, in *Mophie, Inc. v. Source Vista*, Case No. 8:13-CV-01321 in the United States District Court for the Central District of California.

Statement of Genuine Disputes of Material Fact in Opposition to Shah and Serve Global's Motion for Partial Summary Judgment, filed Oct. 3, 2014, in *Mophie, Inc. v. Source Vista*, Case No. 8:13-CV-01321 in the United States District Court for the Central District of California.

Opposition of LivingSocial to Mophie's Motion for Summary Judgment, dated Oct. 3, 2014, in *Mophie, Inc. v. Source Vista*, Case No. 8:13-CV-01321 in the United States District Court for the Central District of California.

Defendants' Opposition to Plaintiff's Motion for Summary Judgment, filed Oct. 3, 2014, in *Mophie, Inc. v. Source Vista*, Case No. 8:13-CV-01321 in the United States District Court for the Central District of California.

Defendants' Response to Plaintiffs Statement of Uncontroverted Material Fact and Contentions of Law, filed Oct. 3, 2014, in *Mophie, Inc. v. Source Vista*, Case No. 8:13-CV-01321 in the United States District Court for the Central District of California.

David Munson Deposition Transcript, dated Sep. 29, 2014, in *Mophie, Inc. v. Source Vista*, Case No. 8:13-CV-01321 in the United States District Court for the Central District of California.

Mophie's First Amended Complaint, filed Jun. 25, 2014, in *Mophie, Inc. v. UNU Electronics Inc.*, Case No. 8:13-CV-01705 in the United States District Court for the Central District of California.

UNU's Answer and Counterclaims, filed Jul. 10, 2014, in *Mophie, Inc. v. UNU Electronics Inc.*, Case No. 8:13-CV-01705 in the United States District Court for the Central District of California.

Mophie's Responses to Defendant's Third Set of Interrogatories (No. 12), dated Aug. 21, 2014, in *Mophie, Inc. v. UNU Electronics Inc.*, Case No. 8:13-CV-01705 in the United States District Court for the Central District of California.

Mophie's Responses to Defendant's First set of Requests for Admissions (Nos. 1-46), dated Aug. 19, 2014, in *Mophie, Inc. v. UNU Electronics Inc.*, Case No. 8:13-CV-01705 in the United States District Court for the Central District of California.

Mophie's Responses to Defendant's Second set of Requests for Admissions (Nos. 47-109), dated Aug. 19, 2014, in *Mophie, Inc. v. UNU Electronics Inc.*, Case No. 8:13-CV-01705 in the United States District Court for the Central District of California.

Request for Ex Parte Reexamination of U.S. Pat. No. 8,367,235, filed Aug. 14, 2014.

Corrected Request for Ex Parte Reexamination of U.S. Pat. No. 8,367,235, filed Sep. 18, 2014.

Declaration of John Feland, Ph.D. In Support of Mophie's Opposition to Defendants Motion for Partial Summary Judgment, filed Oct. 3, 2014, in *Mophie, Inc. v. Source Vista*, Case No. 8:13-CV-01321 in the United States District Court for the Central District of California.

LivingSocial's Reply in Support of Motion for Summary Judgment, Filed Oct. 10, 2014, in *Mophie, Inc. v. Source Vista*, Case No. 8:13-CV-01321 in the United States District Court for the Central District of California.

Defendants' Reply in Support of Motion for Partial Summary Judgment, Filed Oct. 10, 2014, in *Mophie, Inc. v. Source Vista*, Case No. 8:13-CV-01321 in the United States District Court for the Central District of California.

Reply in Support of Mophie's Motion for Summary Judgment, Filed Oct. 10, 2014, in *Mophie, Inc. v. Source Vista*, Case No. 8:13-CV-01321 in the United States District Court for the Central District of California.

Mophie's Reply to Counterclaims of LivingSocial, filed Oct. 14, 2014, in *Mophie, Inc. v. Source Vista*, Case No. 8:13-CV-01321 in the United States District Court for the Central District of California.

Mophie's Reply to Counterclaims of Shah, filed Oct. 14, 2014, in *Mophie, Inc. v. Source Vista*, Case No. 8:13-CV-01321 in the United States District Court for the Central District of California.

Defendant's Response to Mophie's Fourth Set of Interrogatories, dated Sep. 23, 2014, in *Mophie, Inc. v. UNU Electronics Inc.*, Case No. 8:13-CV-01705 in the United States District Court for the Central District of California.

Plaintiff Mophie's Preliminary Claim Constructions and Identification of Extrinsic Evidence, dated Oct. 14, 2014, in *Mophie, Inc. v. UNU Electronics Inc.*, Case No. 8:13-CV-01705 in the United States District Court for the Central District of California.

Defendant's Preliminary Claim Constructions and Extrinsic Evidence, dated Oct. 14, 2014, in *Mophie, Inc. v. UNU Electronics Inc.*, Case No. 8:13-CV-01705 in the United States District Court for the Central District of California.

Plaintiff Mophie's Opening Brief on Claim Construction, filed Oct. 29, 2014, in *Mophie, Inc. v. UNU Electronics Inc.*, Case No. 8:13-CV-01705 in the United States District Court for the Central District of California.

Declaration of John Feland, Ph.D. In Support of Plaintiff's Preliminary Claim Constructions, filed Oct. 29, 2014, in *Mophie, Inc. v. UNU Electronics Inc.*, Case No. 8:13-CV-01705 in the United States District Court for the Central District of California.

Supplemental Declaration of John Feland, Ph.D. in Support of Plaintiff's Claim Constructions, filed Oct. 29, 2014, in *Mophie, Inc. v. UNU Electronics Inc.*, Case No. 8:13-CV-01705 in the United States District Court for the Central District of California.

Declaration of Sheila N. Swaroop in Support of Mophie's Opening Claim Construction Brief, filed Oct. 29, 2014, in *Mophie, Inc. v. UNU Electronics Inc.*, Case No. 8:13-CV-01705 in the United States District Court for the Central District of California.

Transcript of Deposition of John Feland, dated Oct. 21, 2014, in *Mophie, Inc. v. UNU Electronics Inc.*, Case No. 8:13-CV-01705 in the United States District Court for the Central District of California.

Defendant's Opening Claim Construction Brief, dated Oct. 29, 2014, in *Mophie, Inc. v. UNU Electronics Inc.*, Case No. 8:13-CV-01705 in the United States District Court for the Central District of California.

Order Granting Request for Ex Parte Reexamination of U.S. Pat. No. 8,367,235, in Reexamination Control No. 90/013,319, dated Oct. 24, 2014.

Order Re LivingSocial's Motion for Summary Judgment, Mophie's Motion for Summary Judgment, Source Vista and Shah's Motion for Partial Summary Judgment, and Mophie's Motion to Bifurcate, dated Nov. 12, 2014, in *Mophie, Inc. v. Source Vista*, Case No. 8:13-CV-01321 in the United States District Court for the Central District of California.



Mophie's Memorandum in Support of its Motion for Reconsideration, filed Nov. 19, 2014, in *Mophie, Inc. v. Source Vista*, Case No. 8:13-CV-01321 in the United States District Court for the Central District of California.

Declaration of Sheila N. Swaroop in Support of Mophie's Motion for Reconsideration, filed Nov. 19, 2014, in *Mophie, Inc. v. Source Vista*, Case No. 8:13-CV-01321 in the United States District Court for the Central District of California.

Order Denying Plaintiff's Motion for Reconsideration, dated Nov. 21, 2014, in *Mophie, Inc. v. Source Vista*, Case No. 8:13-CV-01321 in the United States District Court for the Central District of California.

Defendants Dharmesh Shah and Serve Global, LLC's Memorandum of Points and Authorities in Support of Defendants's Motion for Attorney's Fees, filed Mar. 21, 2015, in *Mophie, Inc. v. Source Vista*, Case No. 8:13-CV-01321 in the United States District Court for the Central District of California.

Memorandum of Points and Authorities in Support of Livingsocial, Inc.'s Motion for Legal Fees and Costs, filed Mar. 20, 2015, in *Mophie, Inc. v. Source Vista*, Case No. 8:13-CV-01321 in the United States District Court for the Central District of California.

Plaintiff Mophie, Inc.'s Opposition to Defendants Dharmesh Shah and Serve Global, LLC's Motion for Attorneys' Fees, filed Apr. 3, 2015, in *Mophie, Inc. v. Source Vista*, Case No. 8:13-CV-01321 in the United States District Court for the Central District of California.

Plaintiff Mophie, Inc.'s Opposition to Defendant Livingsocial, Inc.'s Motion for Attorneys' Fees, filed Apr. 3, 2015, in *Mophie, Inc. v. Source Vista*, Case No. 8:13-CV-01321 in the United States District Court for the Central District of California.

Reply to Plaintiff's Opposition to Defendants Dharmesh Shah and Serve Global, LLC's Motion for Attorney's Fees, filed Apr. 10, 2015, in *Mophie, Inc. v. Source Vista*, Case No. 8:13-CV-01321 in the United States District Court for the Central District of California.

Reply in Support of Livingsocial, Inc.'s Motion for Legal Fees and Costs, filed Apr. 10, 2015, in *Mophie, Inc. v. Source Vista*, Case No. 8:13-CV-01321 in the United States District Court for the Central District of California.

\* cited by examiner

*Primary Examiner* — Rosemary K Tarca  
*Assistant Examiner* — Christy Nemeth

(74) *Attorney, Agent, or Firm* — Knobbe, Martens, Olson & Bear, LLP

(57)

### CLAIM

The ornamental design for a battery case, as shown and described.

### DESCRIPTION

FIG. 1 is a top-front perspective view of a first embodiment of the design for a battery case in a closed configuration;

FIG. 2 is a bottom-rear perspective view thereof;

FIG. 3 is a front view thereof;

FIG. 4 is a rear view thereof;

FIG. 5 is a left-side view thereof;

FIG. 6 is a right-side view thereof;

FIG. 7 is a top view thereof;

FIG. 8 is a bottom view thereof;

FIG. 9 is a top-front perspective view of the first embodiment of the design for a battery case in an open configuration;

FIG. 10 is a bottom-rear perspective view thereof;

FIG. 11 is a front view thereof;

FIG. 12 is a rear view thereof;

FIG. 13 is a left-side view thereof;

FIG. 14 is a right-side view thereof;

FIG. 15 is a top view thereof;

FIG. 16 is a bottom view thereof;

FIG. 17 is a top-front perspective view of a second embodiment of the design for a battery case in a closed configuration

FIG. 18 is a bottom-rear perspective view thereof;

FIG. 19 is a front view thereof;

FIG. 20 is a rear view thereof;

FIG. 21 is a left-side view thereof;

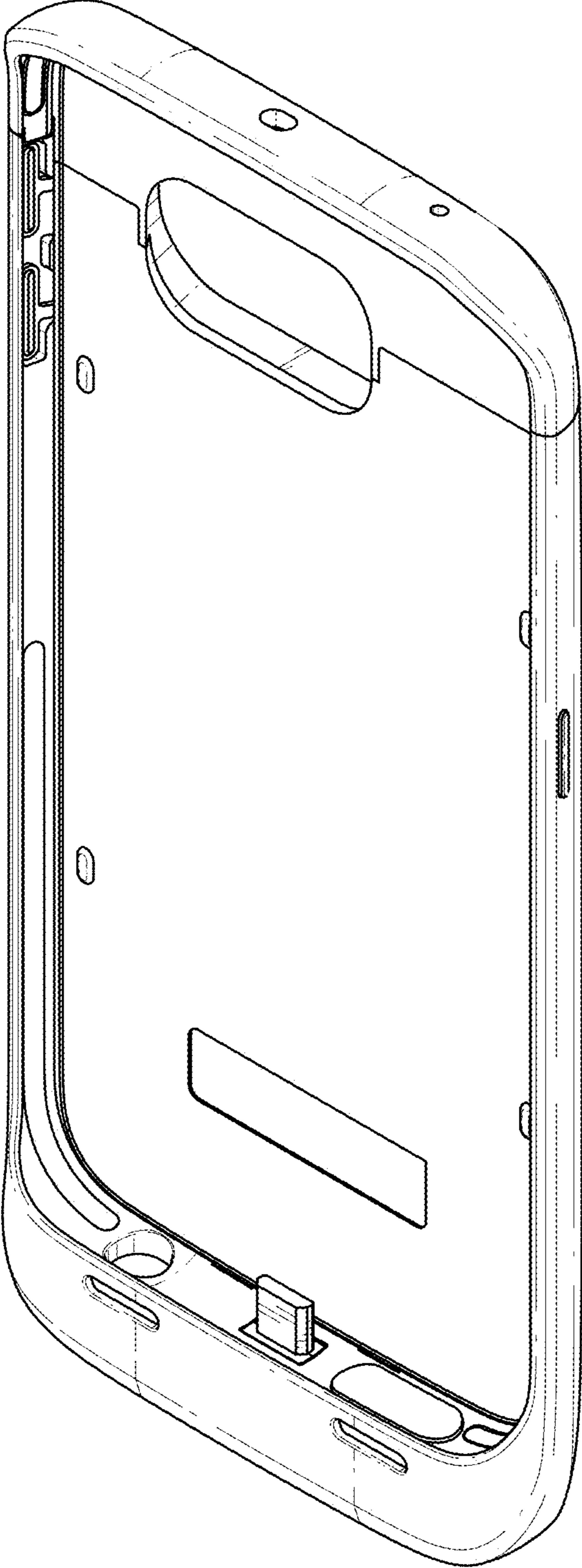
FIG. 22 is a right-side view thereof;

FIG. 23 is a top view thereof; and,

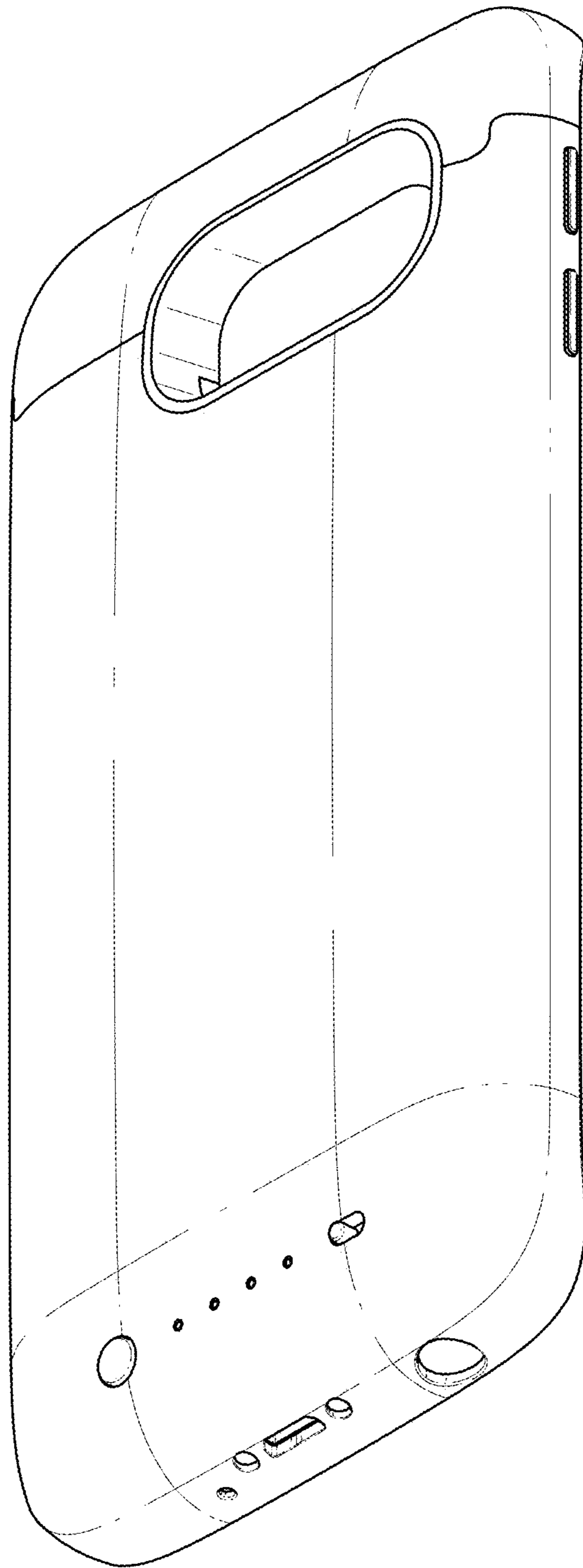
FIG. 24 is a bottom view thereof.

The broken lines in the drawings illustrate unclaimed features of the battery case that form no part of the claimed design.

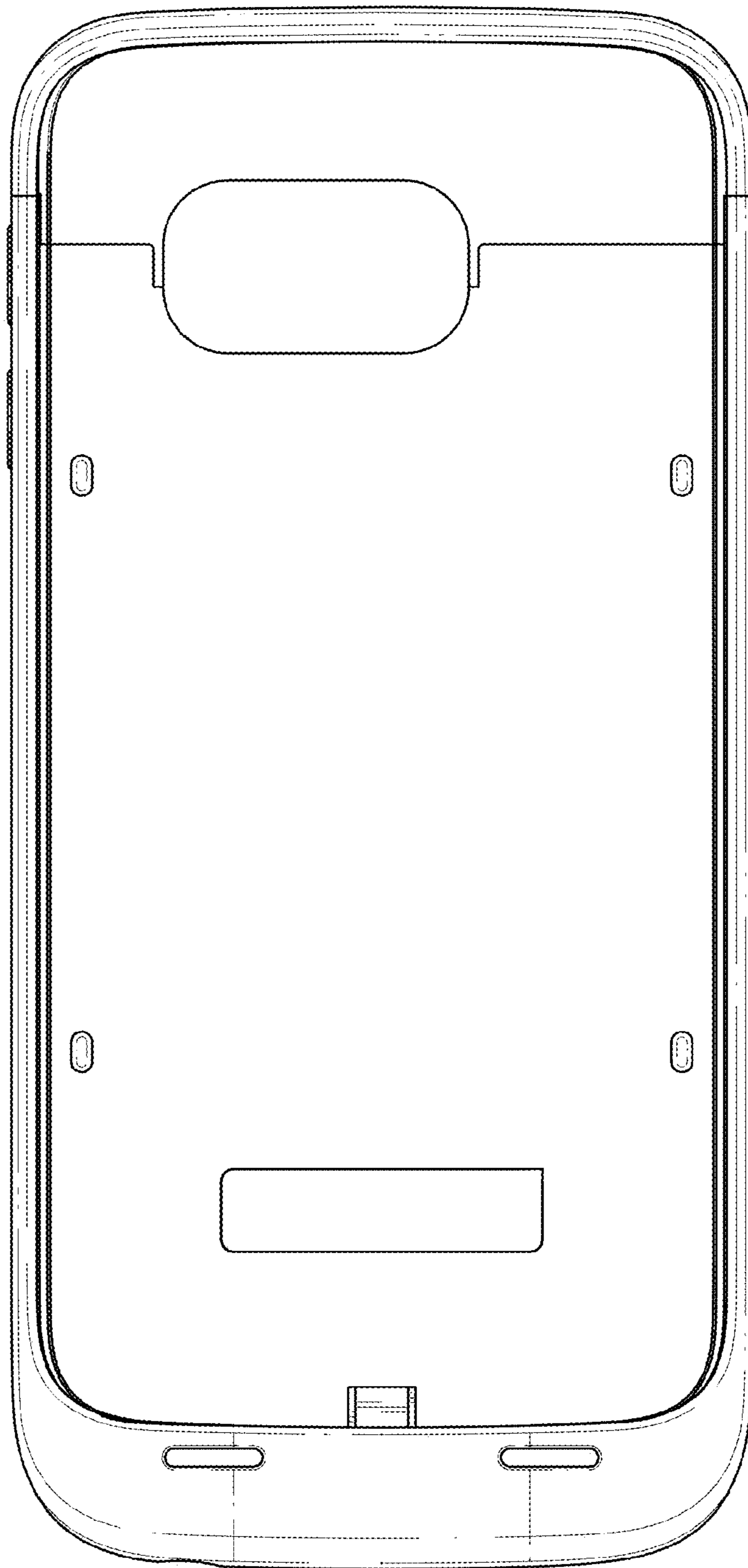
**1 Claim, 18 Drawing Sheets**



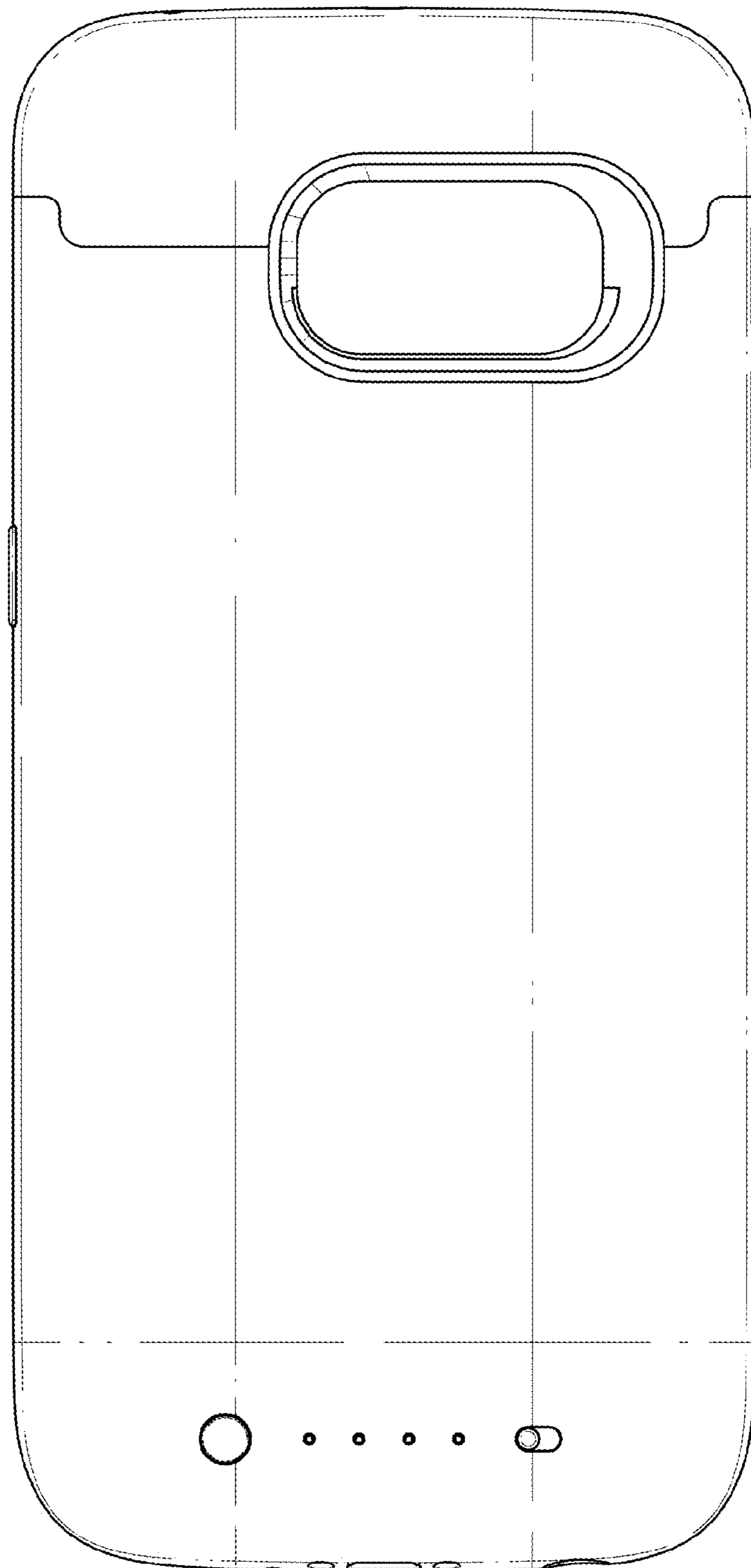
*FIG. 1*



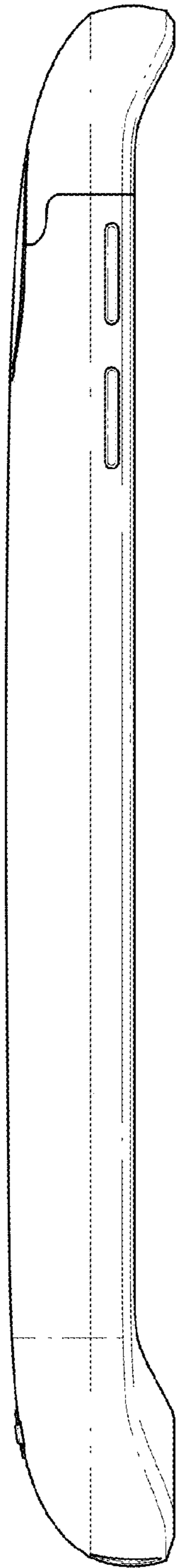
*FIG. 2*



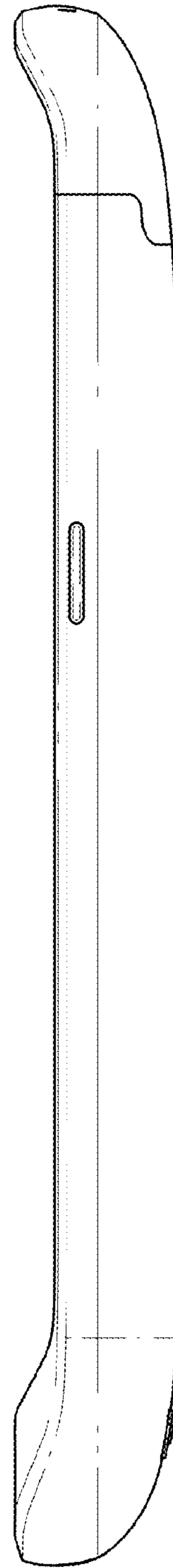
*FIG. 3*



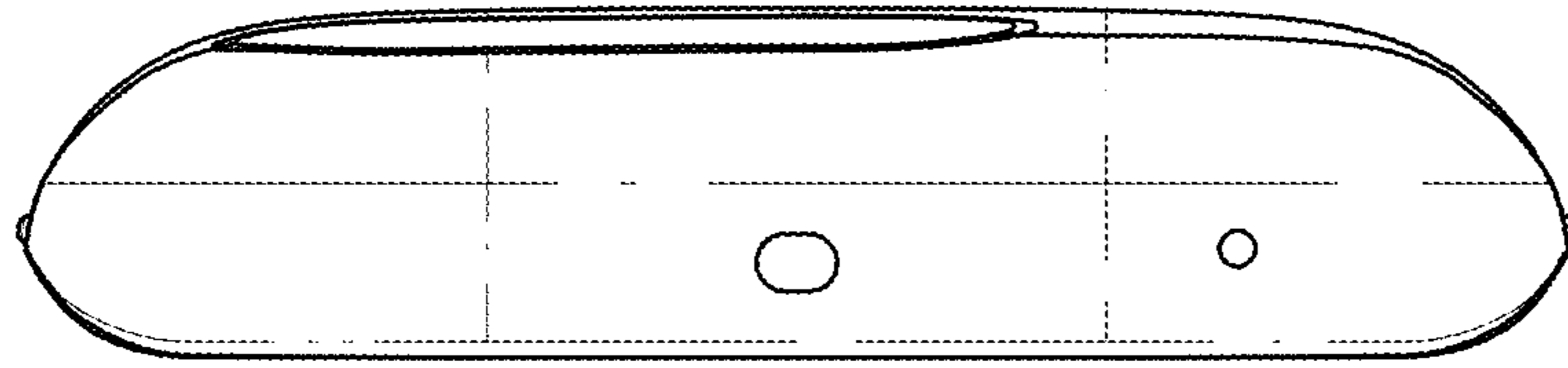
*FIG. 4*



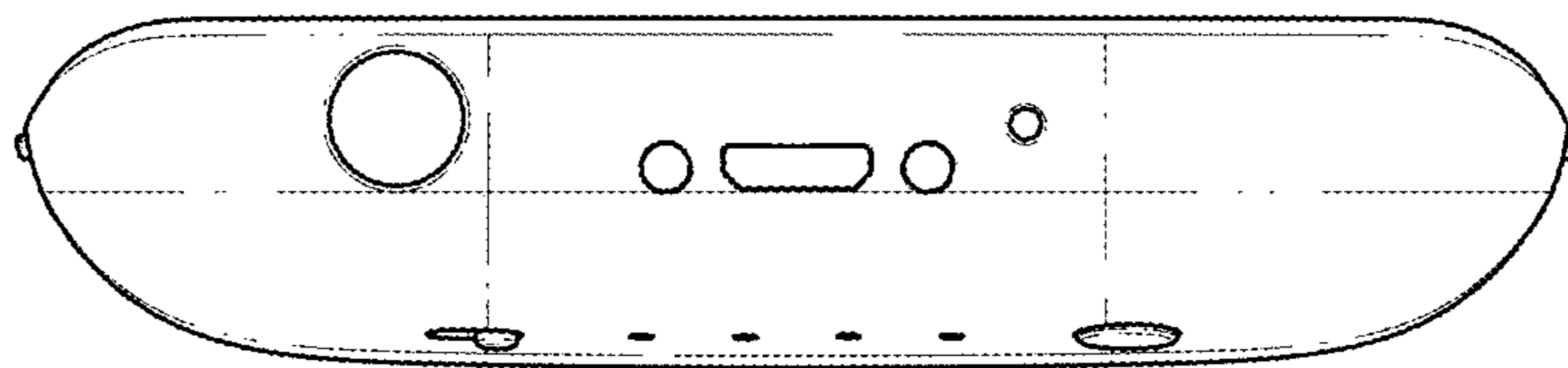
*FIG. 5*



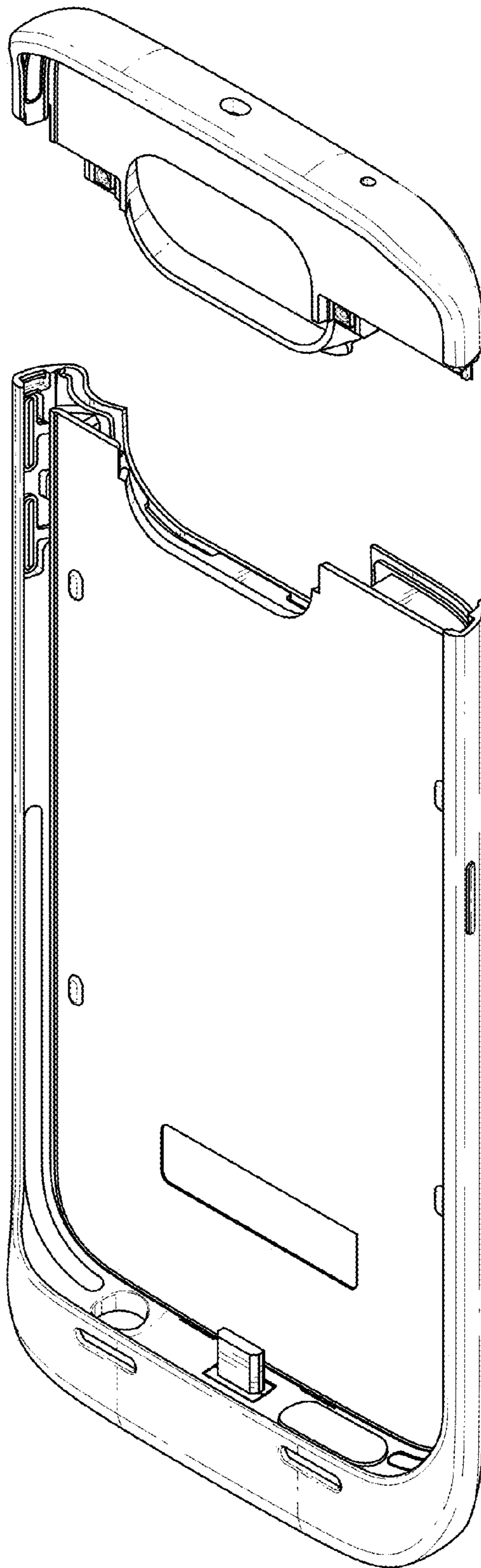
*FIG. 6*



*FIG. 7*



*FIG. 8*



*FIG. 9*



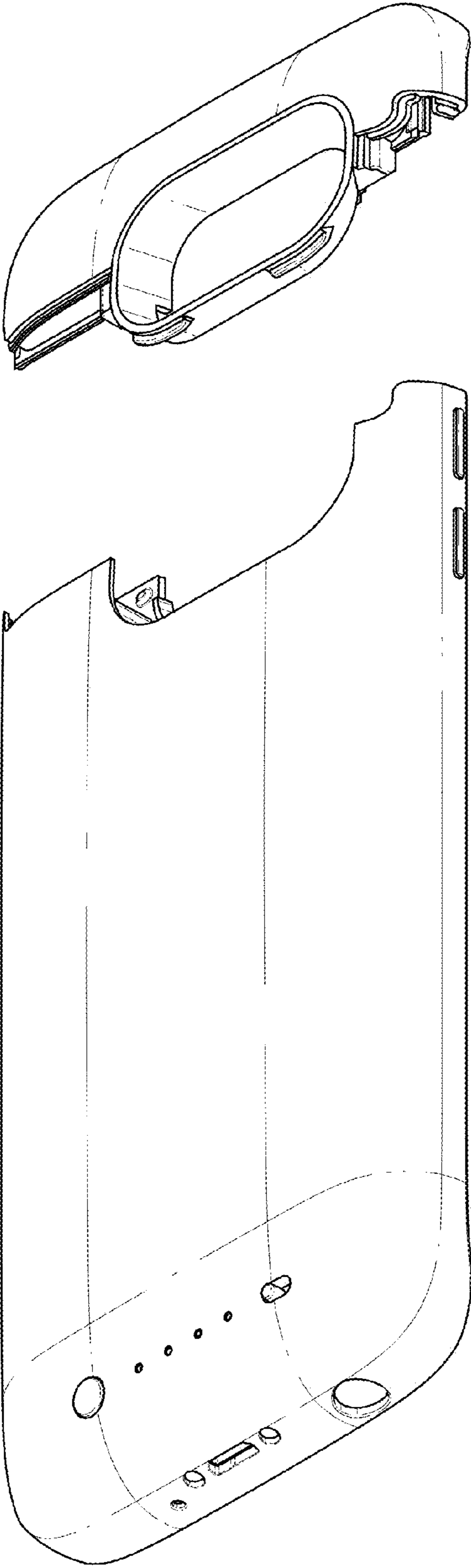
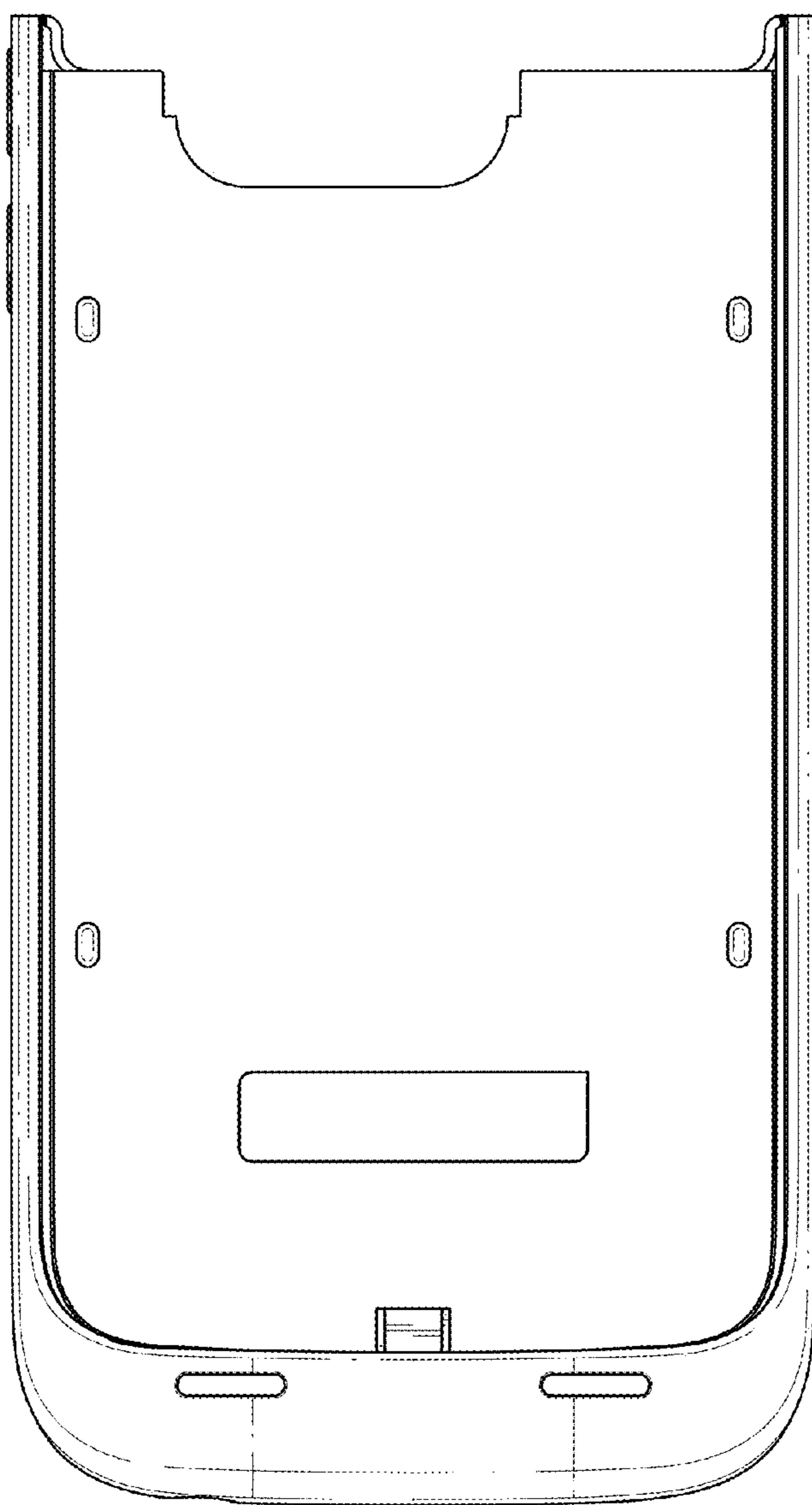
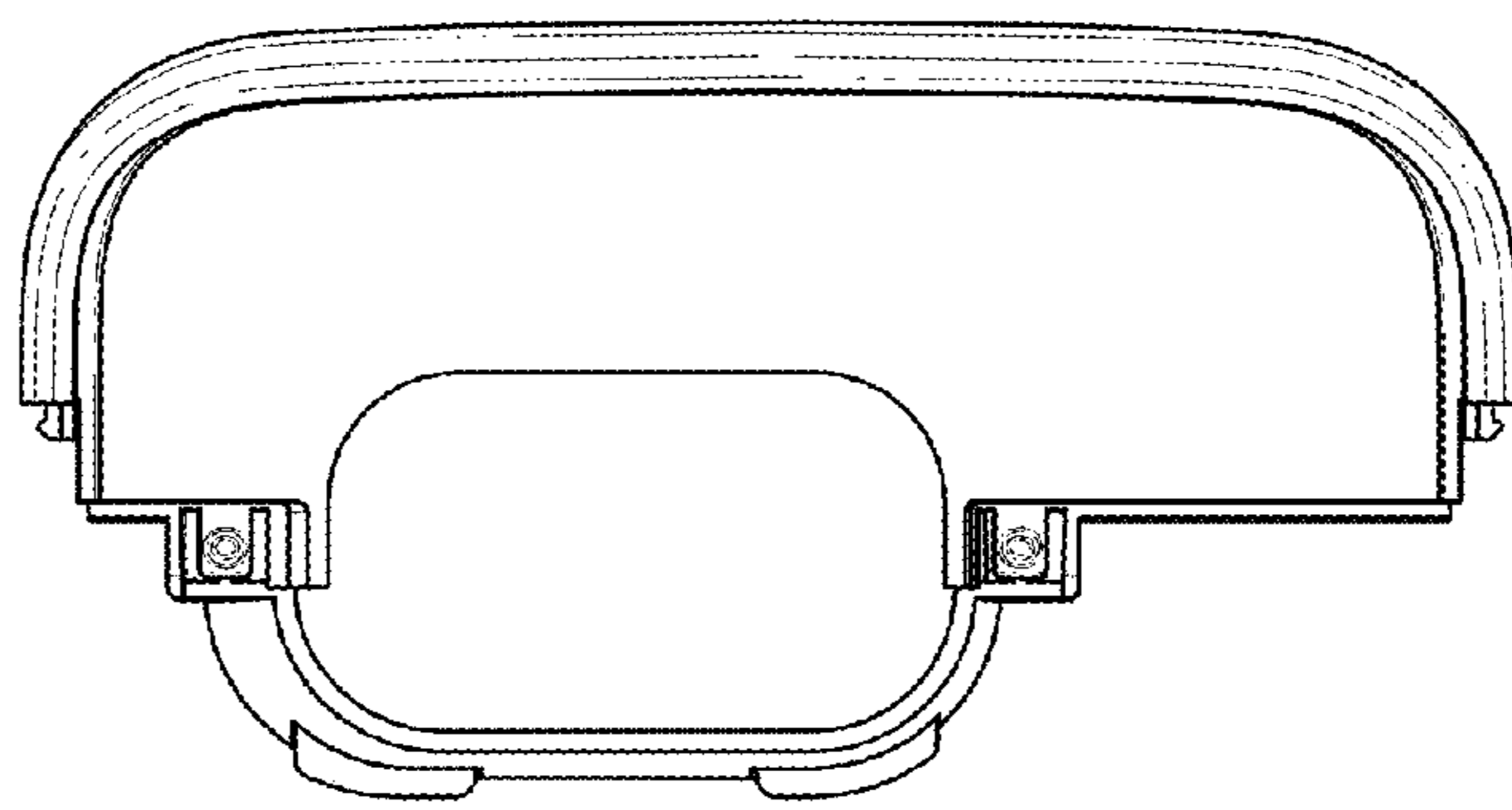


FIG. 10



*FIG. 11*

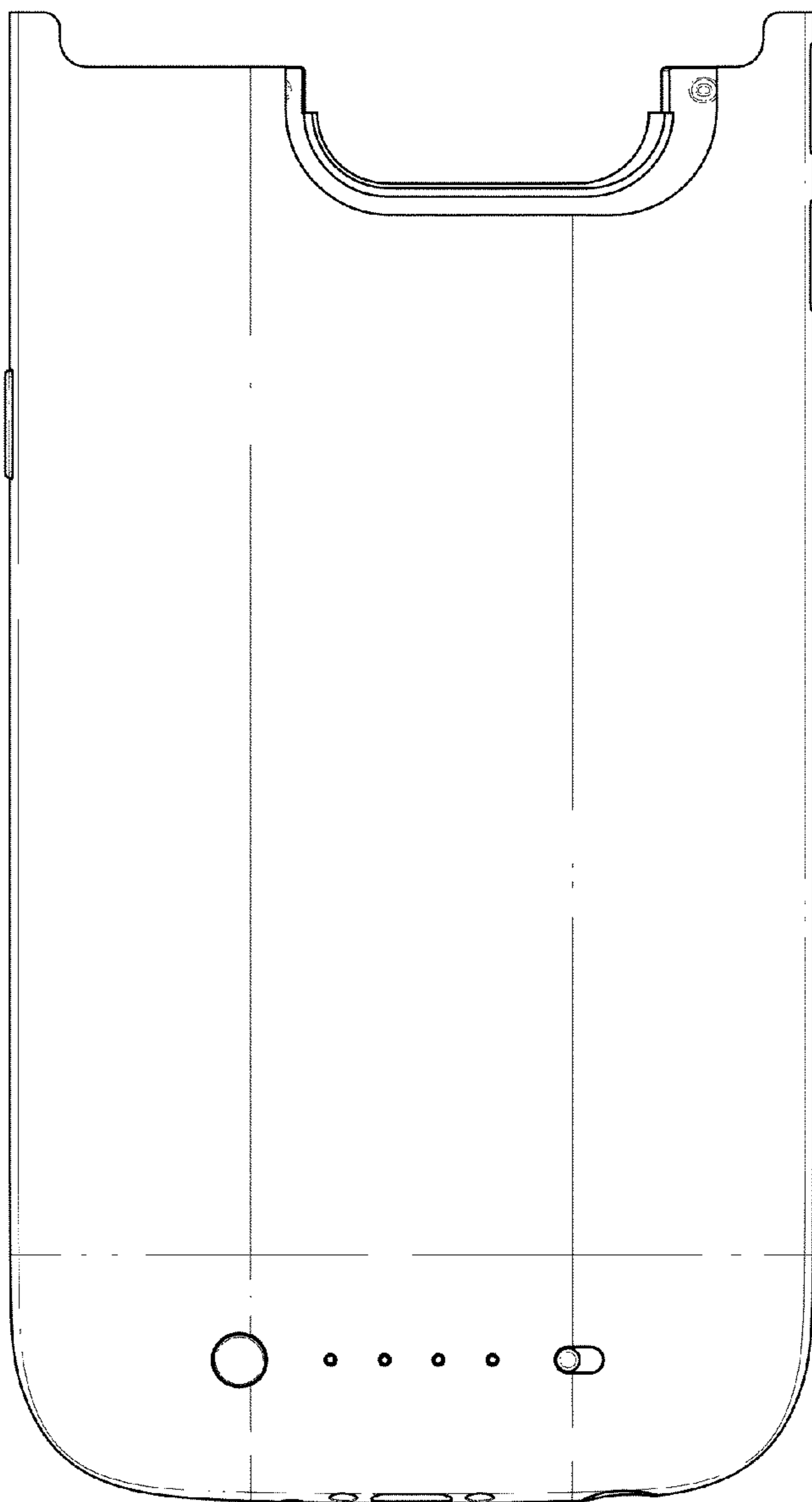
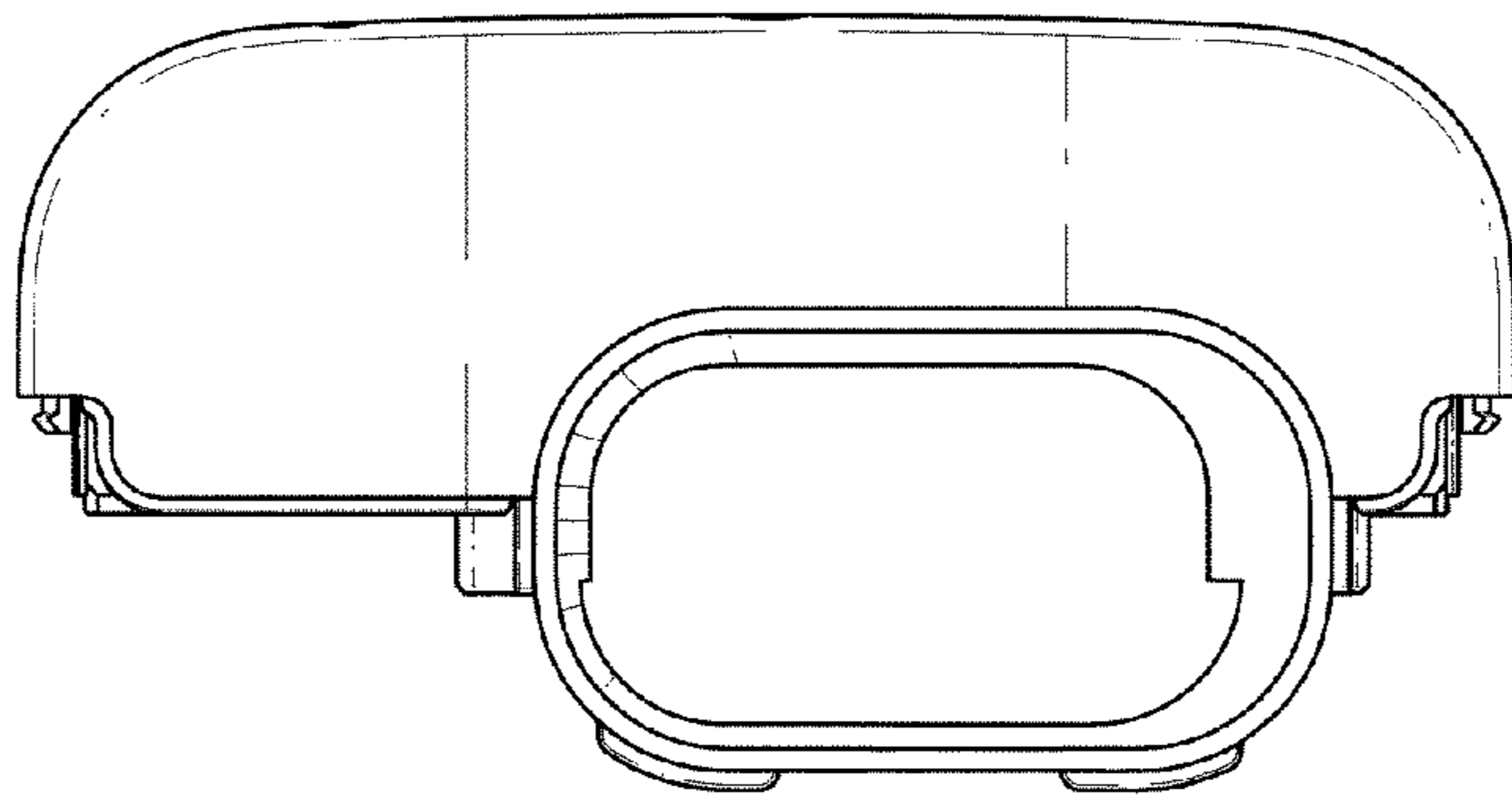
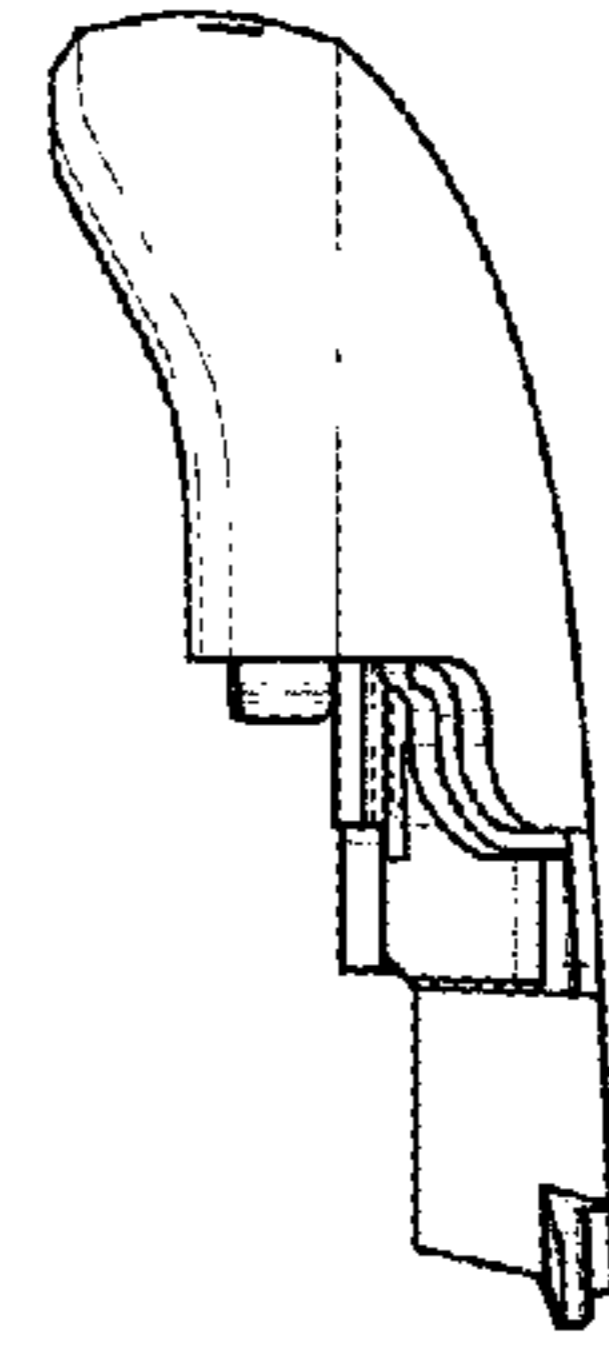
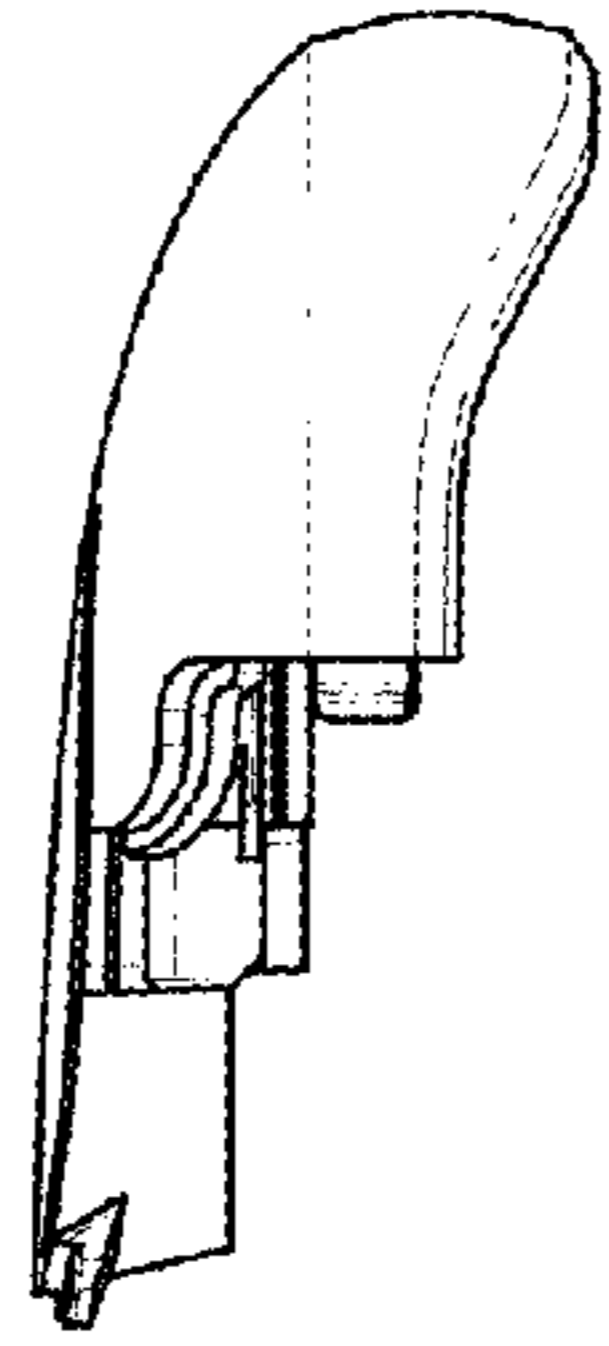
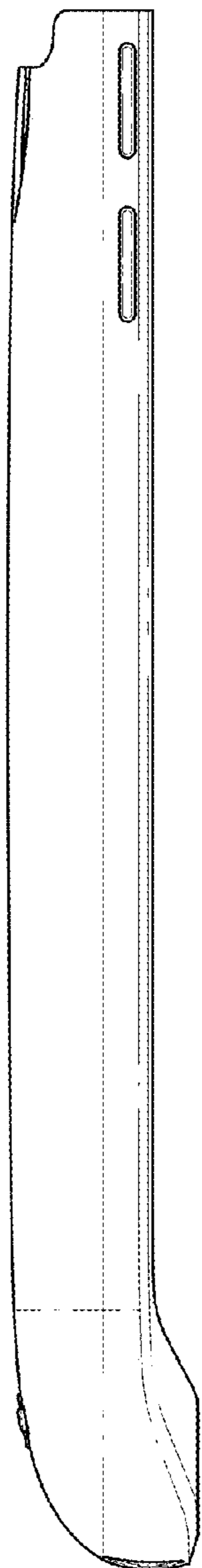


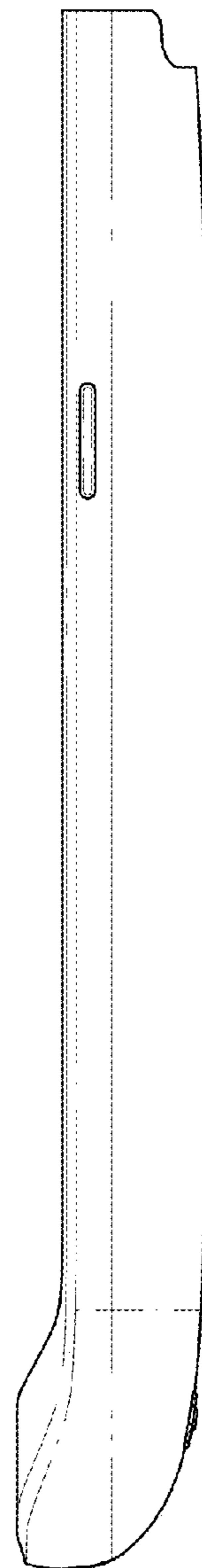
FIG. 12

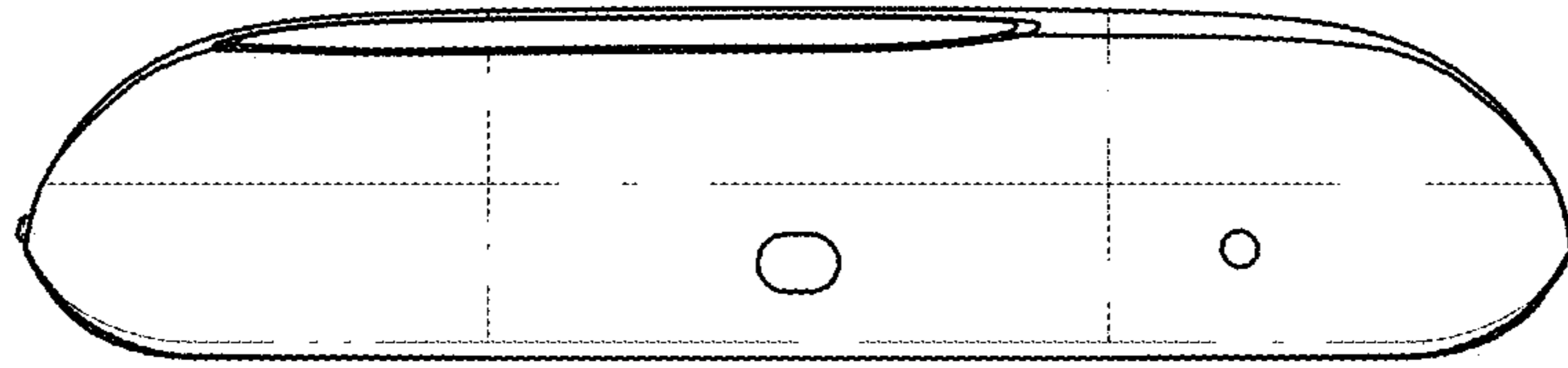


*FIG. 13*

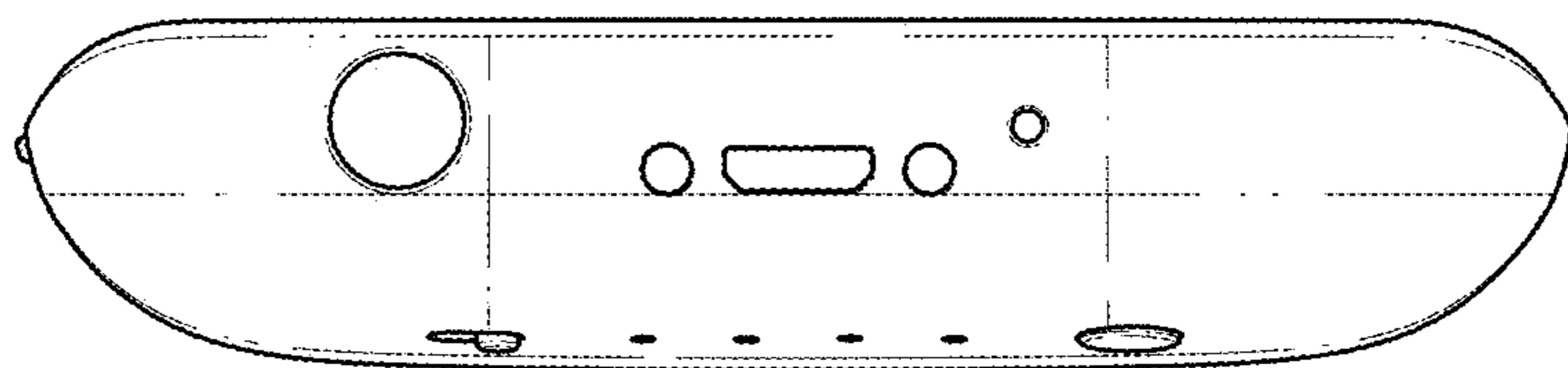


*FIG. 14*

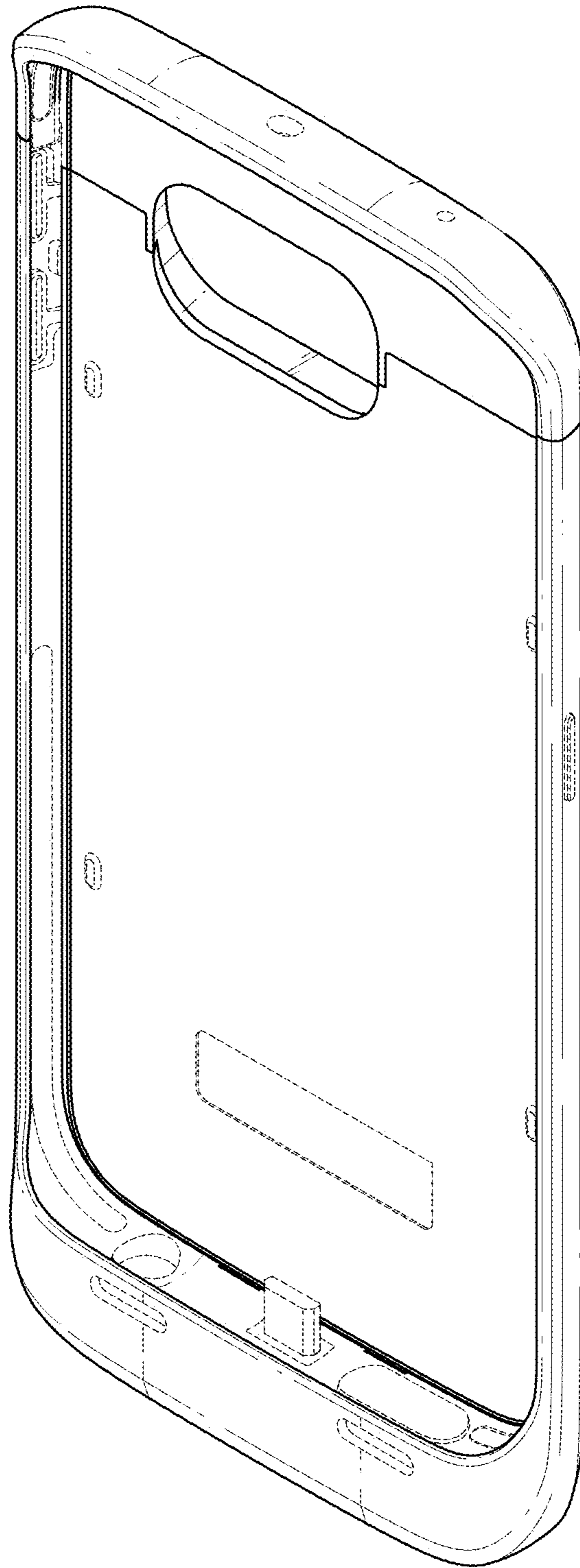




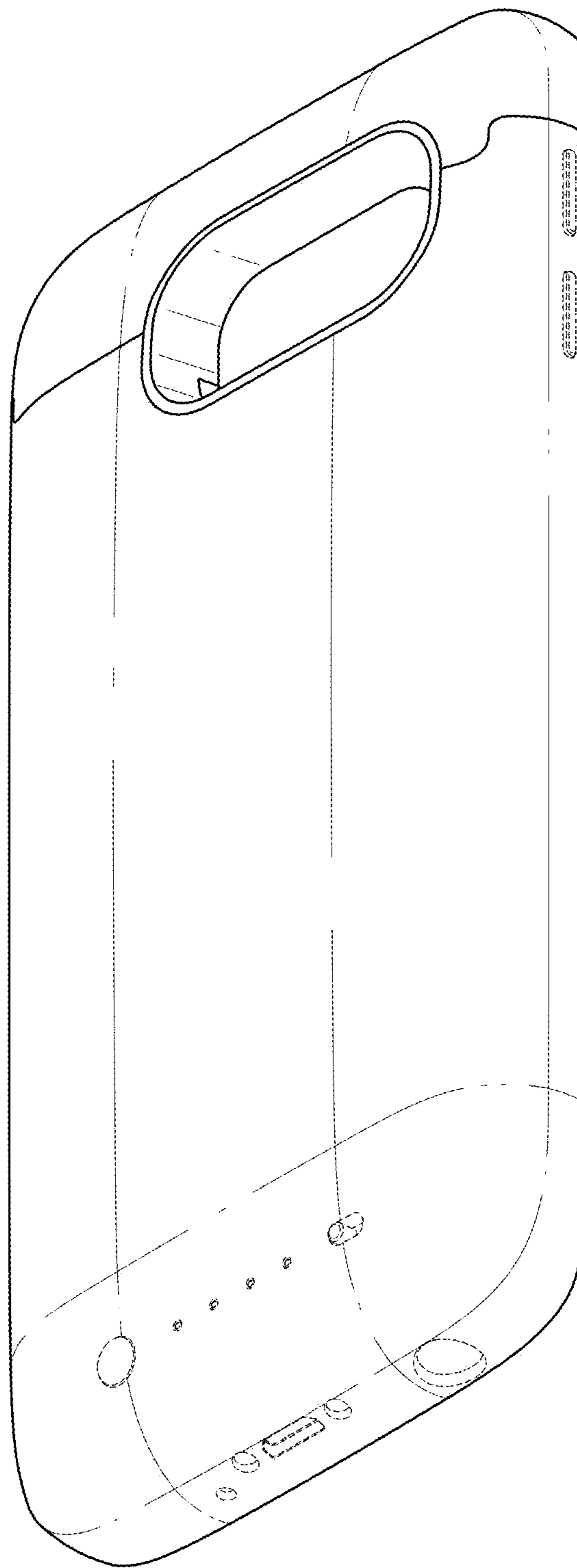
*FIG. 15*



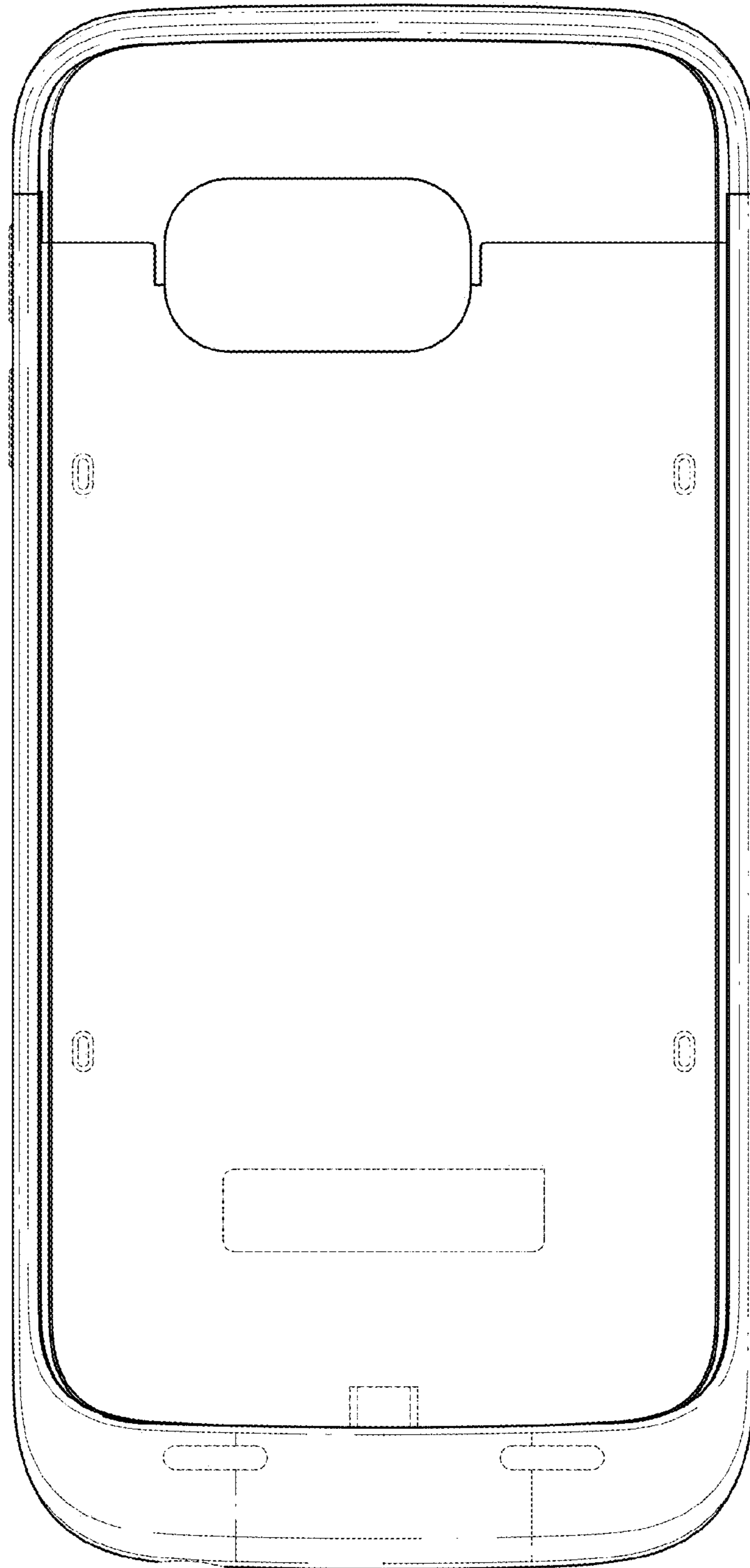
*FIG. 16*



*FIG. 17*

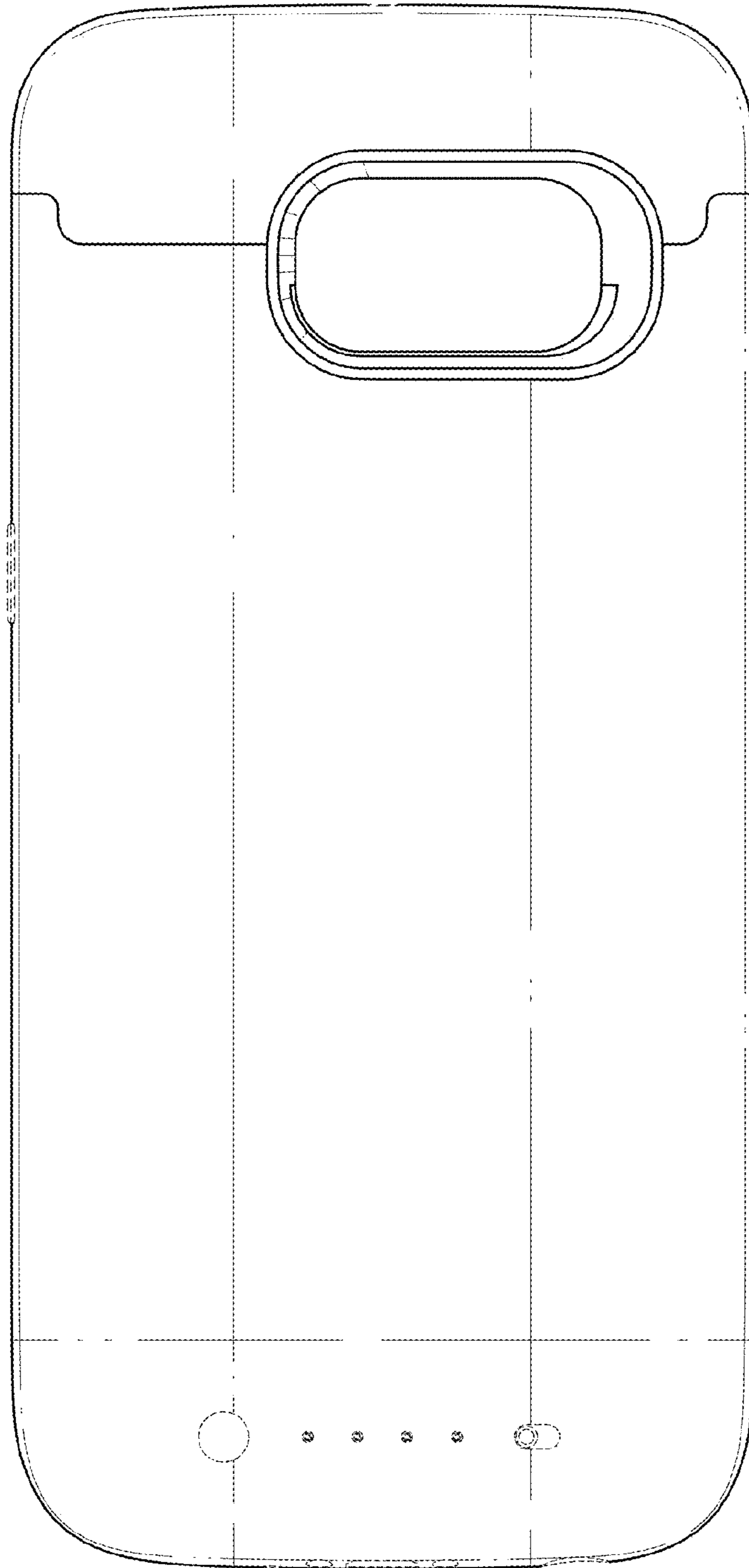


*FIG. 18*

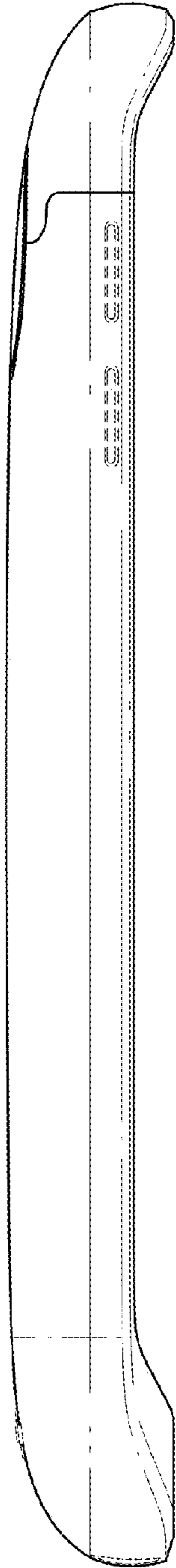


*FIG. 19*

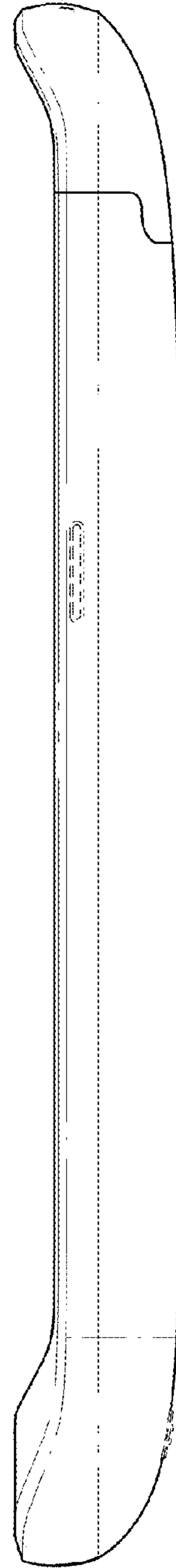




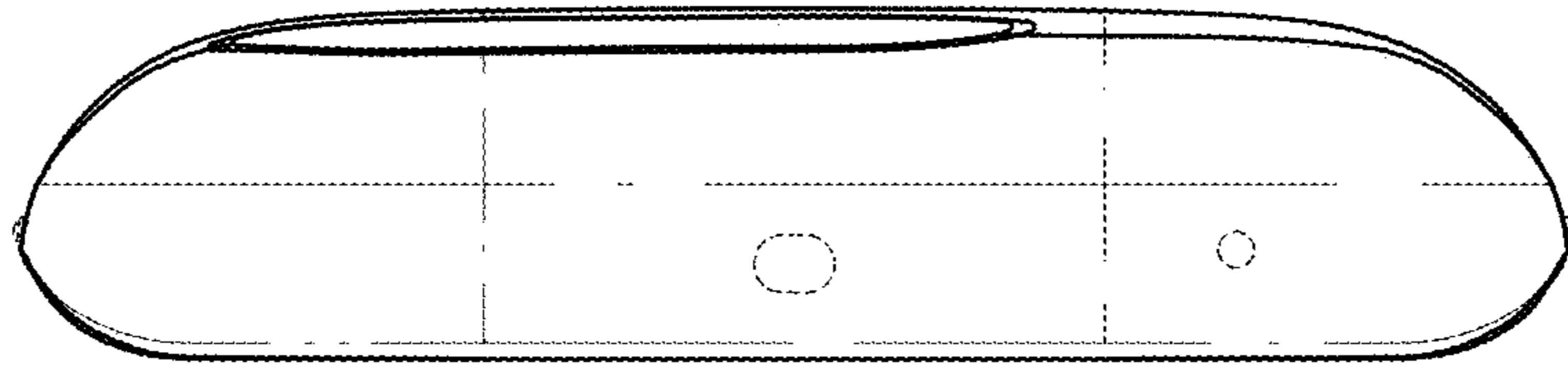
*FIG. 20*



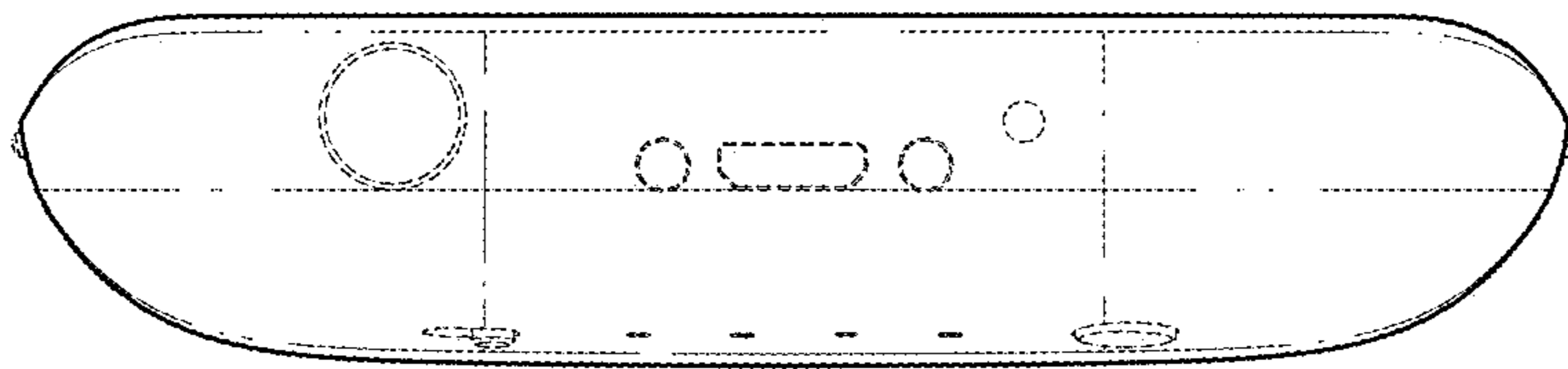
*FIG. 21*



*FIG. 22*



*FIG. 23*



*FIG. 24*