

US00D767440S

(12) **United States Design Patent** (10) **Patent No.:** **US D767,440 S**  
**Schweiger** (45) **Date of Patent:** **\*\* Sep. 27, 2016**

(54) **GEMSTONE**  
 (71) Applicant: **Swarovski Aktiengesellschaft**, Triesen (LI)  
 (72) Inventor: **Christoph Schweiger**, Vomp (AT)  
 (73) Assignee: **Swarovski Aktiengesellschaft** (LI)  
 (\*\*) Term: **14 Years**

D605,549 S \* 12/2009 Renner ..... D11/89  
 D610,937 S \* 3/2010 Meyer ..... D11/89  
 D649,904 S \* 12/2011 Froehlich ..... D11/89  
 D653,152 S \* 1/2012 Bartl ..... D11/89  
 D654,824 S \* 2/2012 Bartl ..... D11/89  
 D656,863 S \* 4/2012 Ehrenstrasser ..... D11/89  
 D661,221 S \* 6/2012 Neuner ..... D11/89  
 D672,268 S \* 12/2012 Hodzic ..... D11/89  
 D673,072 S \* 12/2012 Hodzic ..... D11/89  
 D674,312 S \* 1/2013 Hodzic ..... D11/89  
 D691,915 S \* 10/2013 Hodzic ..... D11/89  
 D753,537 S \* 4/2016 Modi ..... D11/90

(21) Appl. No.: **29/523,123**

(22) Filed: **Apr. 7, 2015**

(51) **LOC (10) Cl.** ..... **11-01**

(52) **U.S. Cl.**  
USPC ..... **D11/89**

(58) **Field of Classification Search**  
USPC ..... D11/1-2, 26-29, 89-92; 63/26-28, 32  
CPC ..... A44C 17/00  
See application file for complete search history.

(56) **References Cited**

**U.S. PATENT DOCUMENTS**

D543,893 S \* 6/2007 Tabertshofer ..... D11/90  
 D560,547 S \* 1/2008 Kumar ..... D11/90  
 D585,325 S \* 1/2009 Rossmann ..... D11/90

\* cited by examiner

*Primary Examiner* — Ralf Seifert  
(74) *Attorney, Agent, or Firm* — Baker & McKenzie LLP

(57) **CLAIM**  
The ornamental design for an ornamental gemstone, as shown and described.

**DESCRIPTION**

FIG. 1 is a front perspective view showing my new design;  
 FIG. 2 is a front thereof;  
 FIG. 3 is a rear view thereof;  
 FIG. 4 is a right side view thereof;  
 FIG. 5 is a left side view thereof;  
 FIG. 6 is a top view thereof; and,  
 FIG. 7 is a bottom view thereof.

**1 Claim, 7 Drawing Sheets**

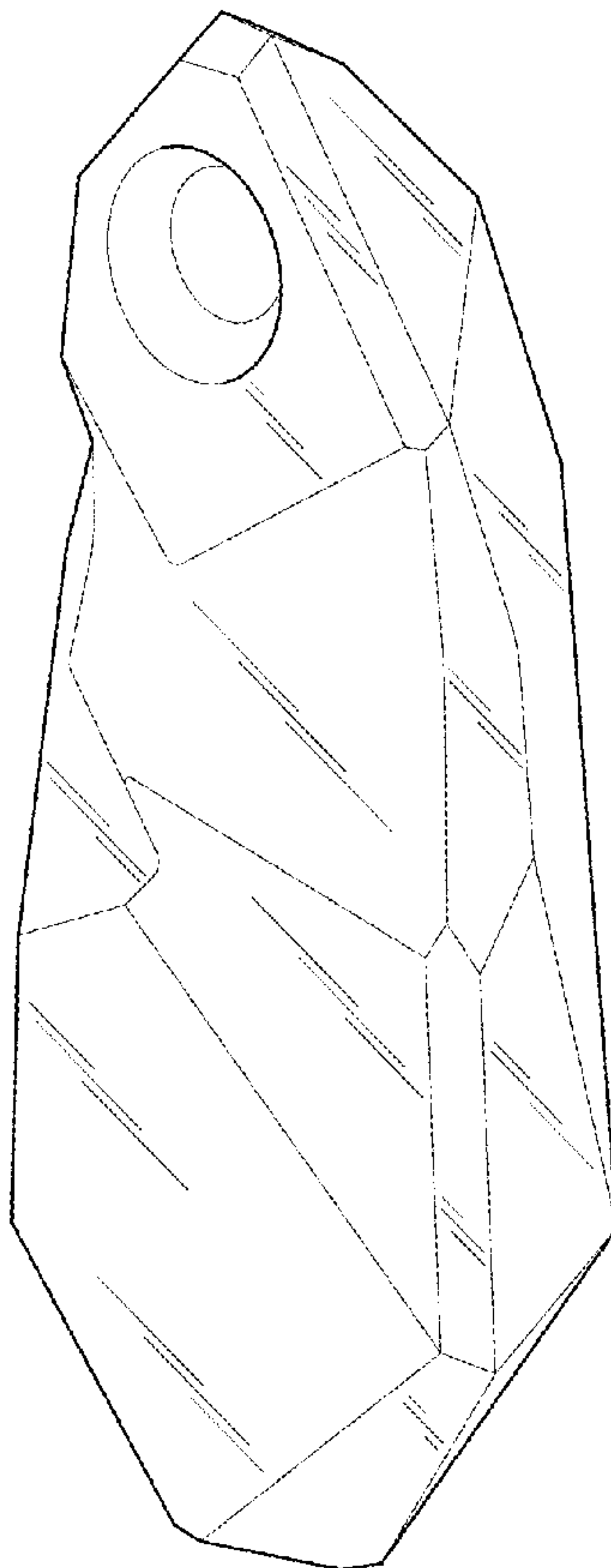

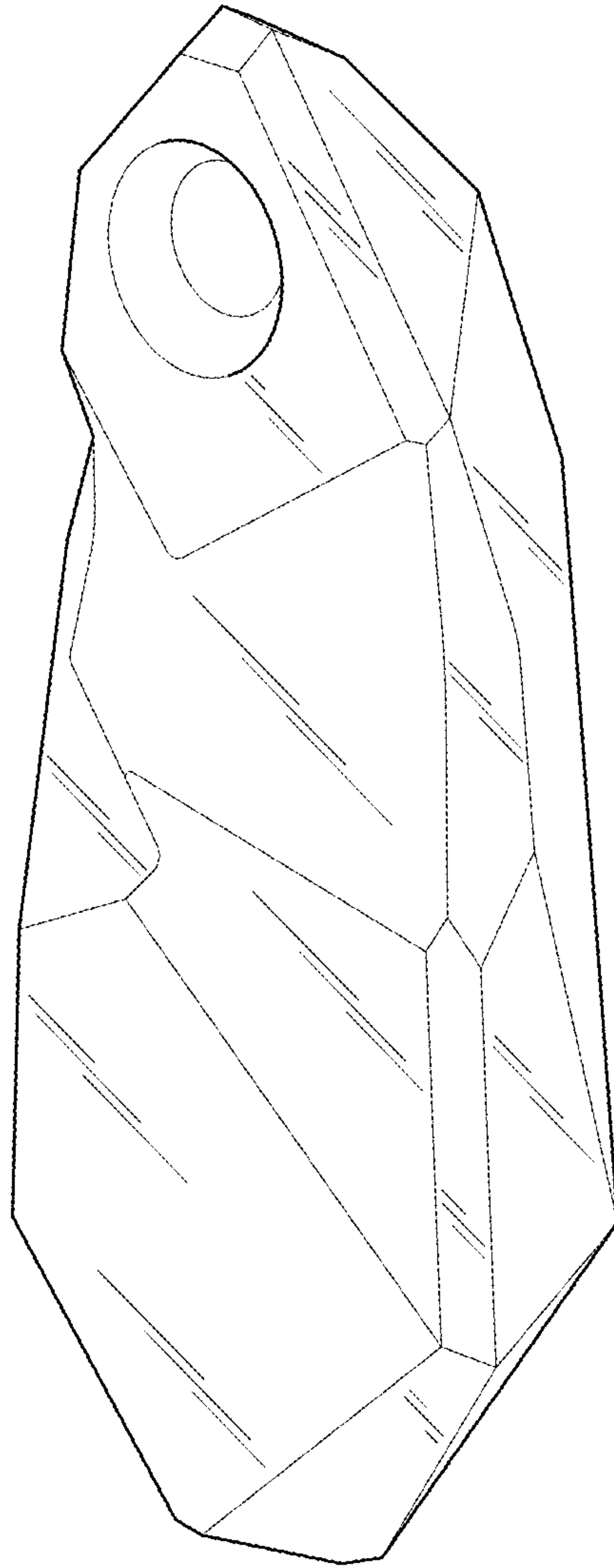

FIG. 1

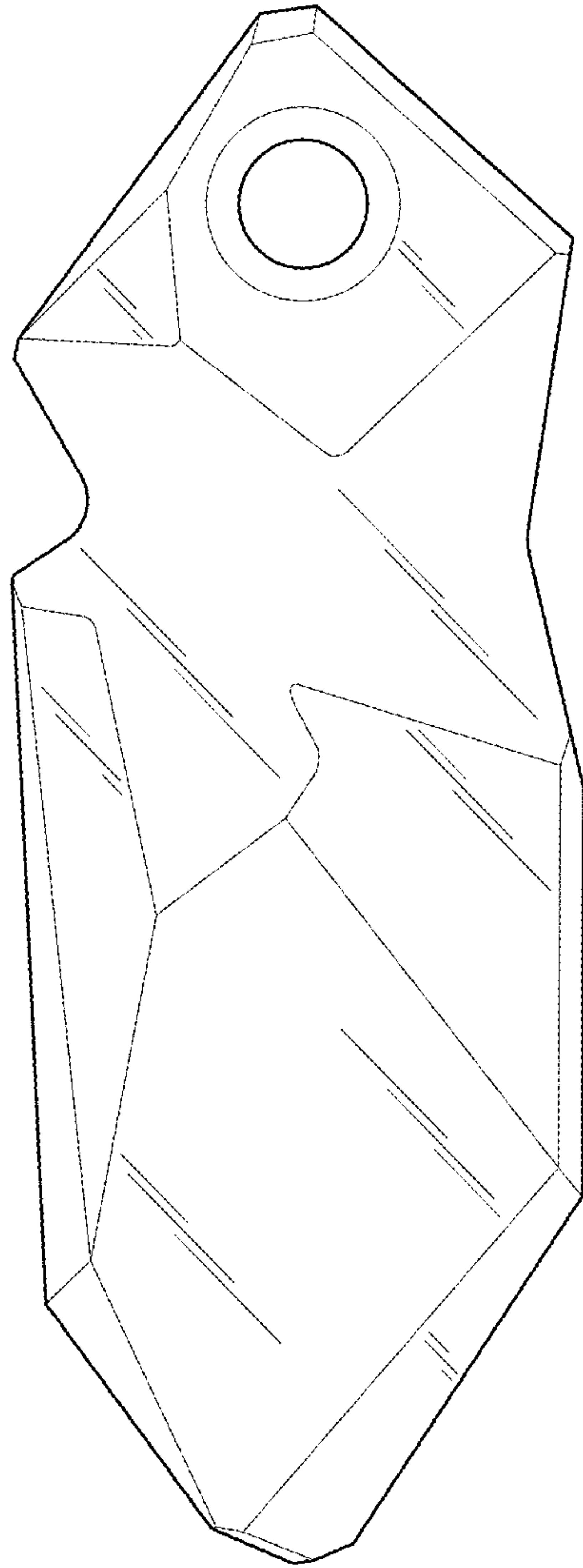

FIG. 2

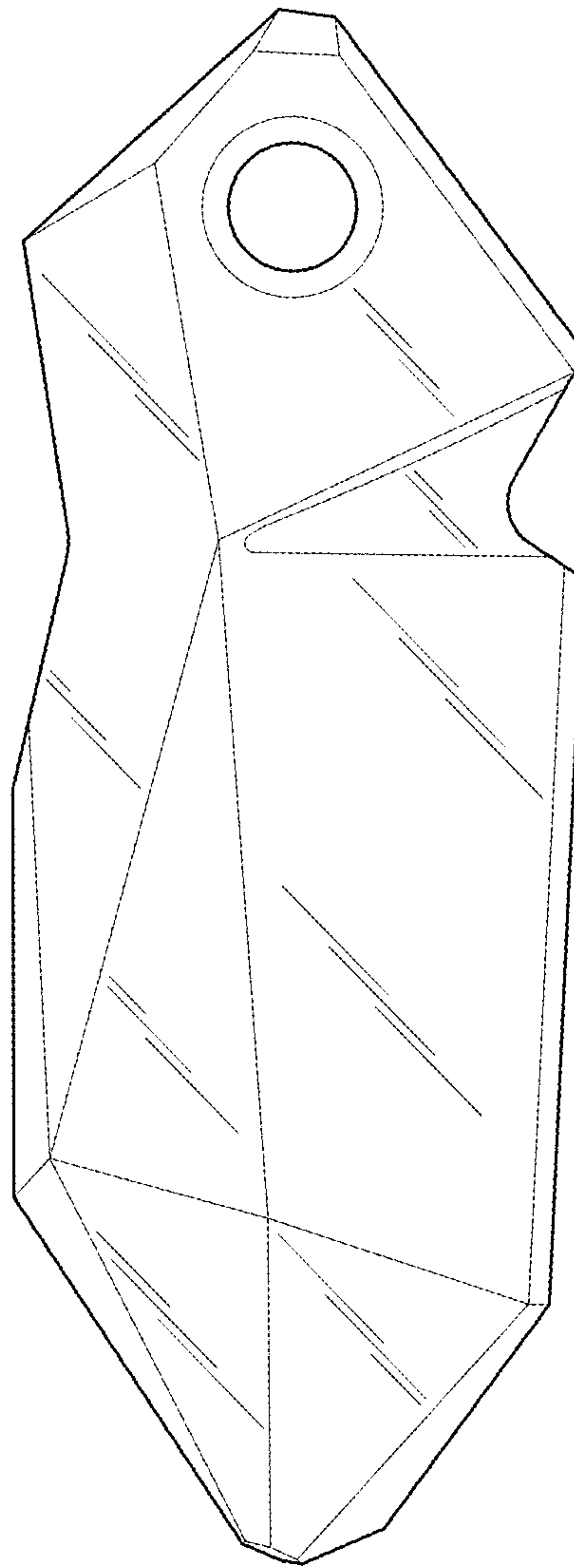

FIG. 3

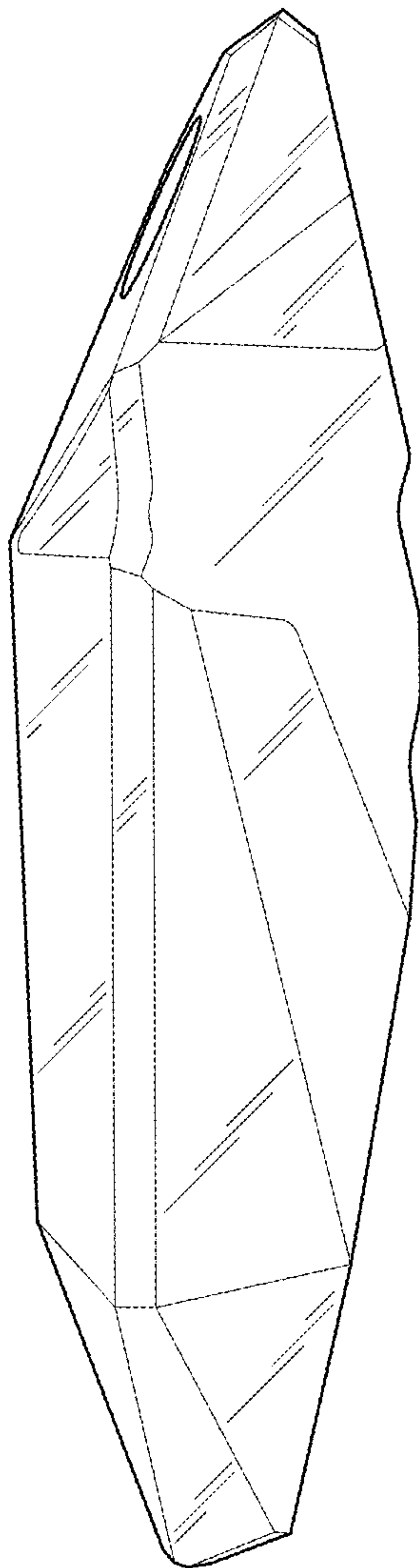

FIG.4

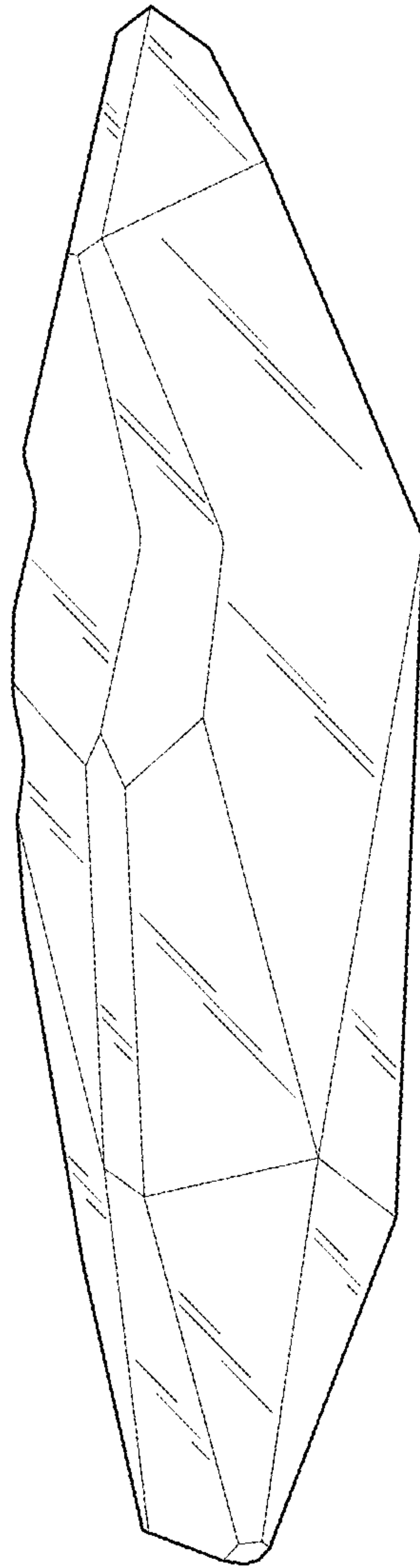

FIG. 5

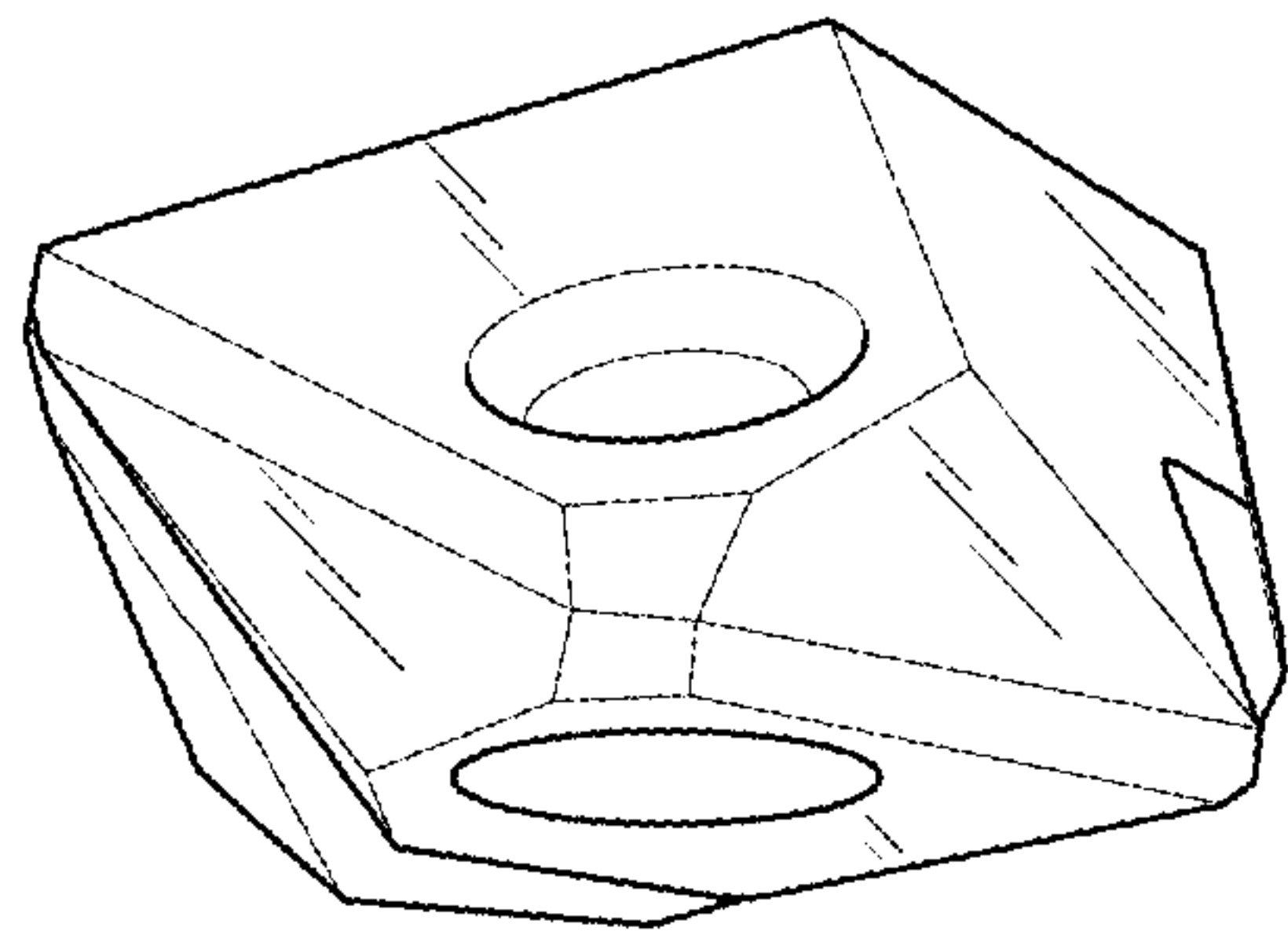

FIG. 6

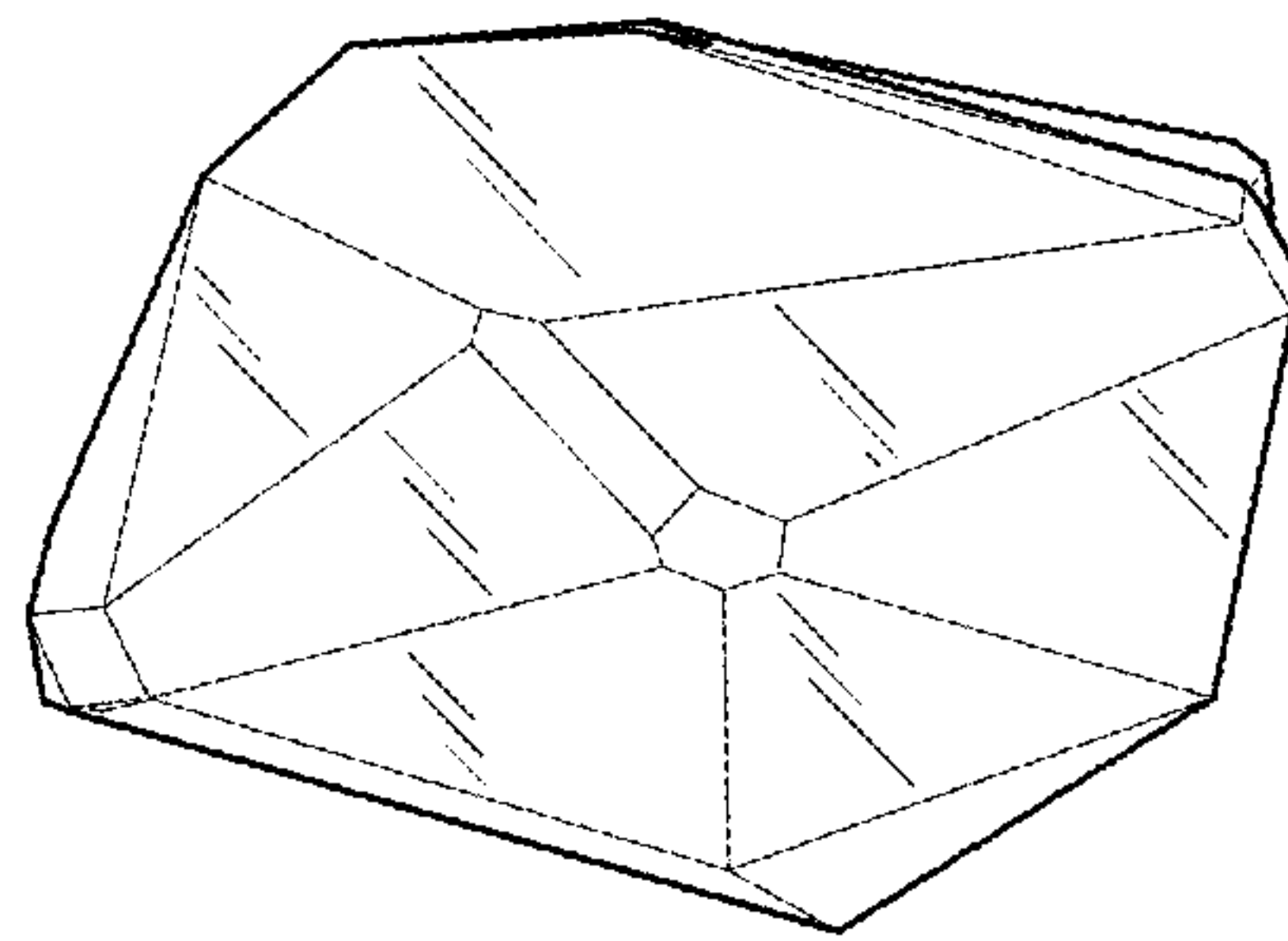

FIG. 7