

US00D767255S

(12) **United States Design Patent**
Marino

(10) **Patent No.:** **US D767,255 S**
(45) **Date of Patent:** **** Sep. 27, 2016**

(54) **PUTTER POCKET**

- (71) Applicant: **RAM Group, Inc.**, Milwaukee, WI (US)
- (72) Inventor: **Rick A. Marino**, Milwaukee, WI (US)
- (73) Assignee: **RAM Group, Inc.**, Milwaukee, WI (US)

(**) Term: **14 Years**

(21) Appl. No.: **29/491,484**

(22) Filed: **May 21, 2014**

(51) **LOC (10) Cl.** **02-02**

(52) **U.S. Cl.**
USPC **D2/750**

(58) **Field of Classification Search**
 USPC D2/750, 844, 847, 720, 700, 717, 857,
 D2/840; D6/608; 2/128, 115, 123, 69, 108,
 2/202, 2.5; 381/376
 CPC A41D 15/00; A41D 27/10; A41D 13/012;
 A41D 1/002; A42B 1/045; F41H 1/02
 See application file for complete search history.

(56) **References Cited**

U.S. PATENT DOCUMENTS

D115,983	S	*	8/1939	Bailey	2/128
D217,422	S	*	5/1970	Traeger	D2/844
D247,331	S	*	2/1978	Nally	D2/844
D247,526	S	*	3/1978	Nally	D2/844
D271,154	S	*	11/1983	Dowling	D2/847
5,664,259	A	*	9/1997	Budd	A41D 15/00 2/115
D384,717	S	*	10/1997	Hodges	D6/608
D385,386	S	*	10/1997	Lancaster	D2/720
D393,736	S	*	4/1998	Rubin	D2/700
5,815,837	A	*	10/1998	Christman	A41D 27/10 2/123
D410,317	S	*	6/1999	Alexander	D2/840

(Continued)

FOREIGN PATENT DOCUMENTS

FR 20133403-001 * 4/2014

OTHER PUBLICATIONS

Assos Sleeveless Hoodie in Black for Men, Announced Sep. 7, 2011, [Site visited Apr. 13, 2016]https://www.lyst.com/clothing/asos-sleeveless-hoodie-black-2/?product_gallery=26874004.*

(Continued)

Primary Examiner — John Windmuller

Assistant Examiner — Luqman McNeil

(74) *Attorney, Agent, or Firm* — Boyle Fredrickson, S.C.

(57) **CLAIM**

The ornamental design for a putter pocket, as shown and described.

DESCRIPTION

FIG. 1 is a front view of the putter pocket attached to an article of clothing with an individual inserting a flying disc, or disc golf putter, into the pocket;

FIG. 2 is a front view of the invention with the putter pocket in an open position;

FIG. 3 is a front view of the invention with the putter pocket held in a closed position with a suitable fastener such as hook and loop material;

FIG. 4 is a rear view of the invention;

FIG. 5 is a right side view of the invention with the putter pocket in a closed position with a suitable fastener such as hook and loop material;

FIG. 6 is a left side view of the invention with the putter pocket in a closed position with a suitable fastener such as hook and loop material; and,

FIG. 7 is a perspective, exploded view of the invention showing the individual parts of an article of clothing and the putter pocket.

The broken lines are included for the purpose of illustrating portions of the putter pocket that form no part of the claimed design. Cross-hatch marks are used only to indicate fabric and contour and are not part of the claimed design.

1 Claim, 5 Drawing Sheets

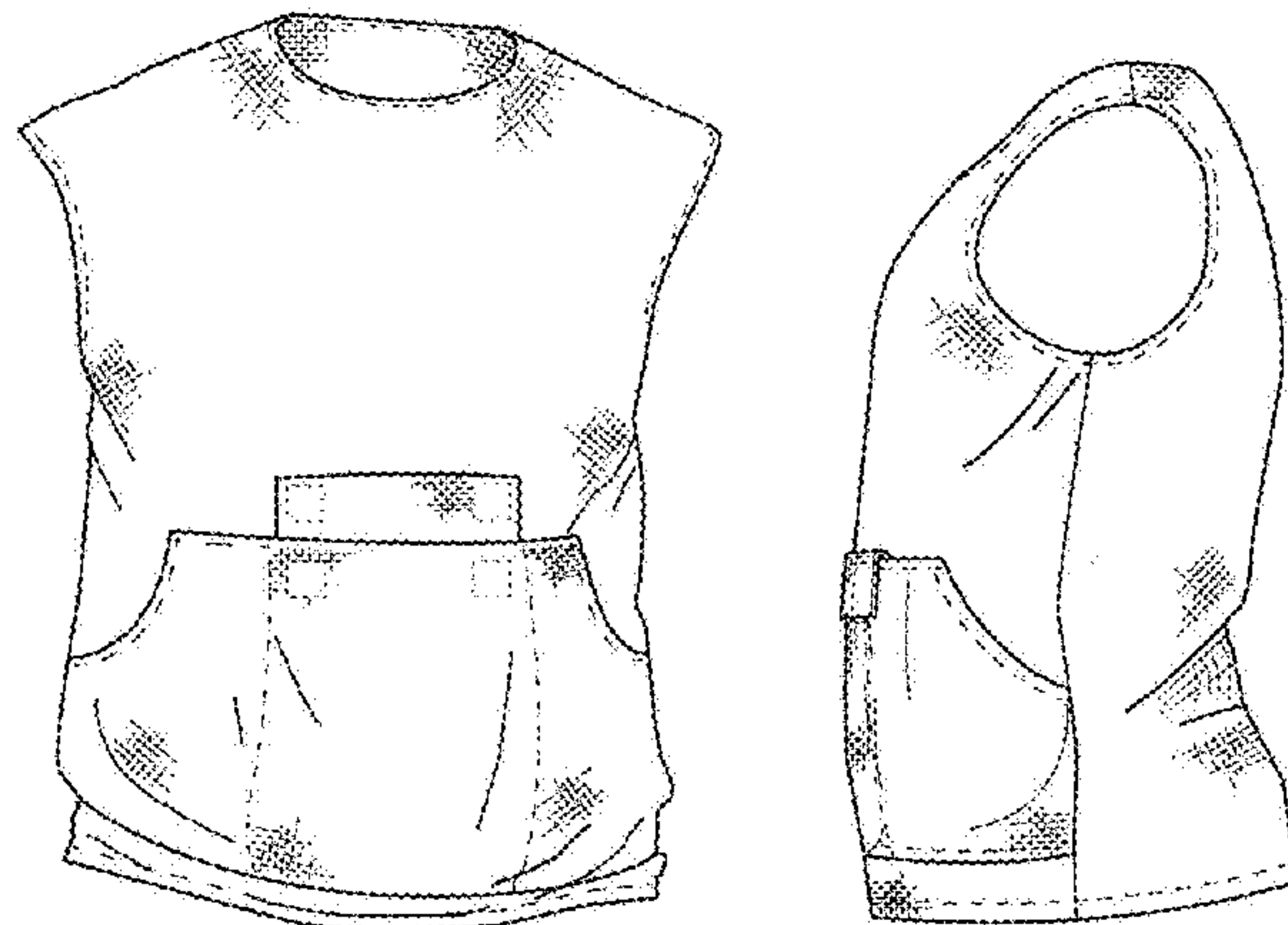

(56)

References Cited

U.S. PATENT DOCUMENTS

5,913,408 A * 6/1999 Shanahan A41D 27/10
2/69
6,237,152 B1 * 5/2001 Gootrad A41D 13/012
2/108
6,532,596 B1 * 3/2003 Fosmo A42B 1/045
2/202
6,839,911 B1 * 1/2005 Mathews A41D 15/00
2/69
D509,947 S * 9/2005 Fortune D2/840
D510,794 S * 10/2005 Rice D2/840
D526,764 S * 8/2006 Toomey D2/840
D570,577 S 6/2008 Keppler
D575,933 S * 9/2008 Rhodes D2/840
D581,136 S * 11/2008 Cross D2/840

D584,482 S * 1/2009 Marsh D2/717
D608,983 S * 2/2010 Myers D2/857
D619,782 S * 7/2010 Rhodes D2/717
D648,923 S * 11/2011 Morales D2/750
D689,669 S * 9/2013 Williams D2/857
D691,348 S * 10/2013 Glaze D2/840
2008/0263737 A1 * 10/2008 Parks F41H 1/02
2/2.5
2010/0329499 A1 * 12/2010 Wolfe A41D 1/002
381/376

OTHER PUBLICATIONS

Sleeveless Hoodie DC Hoodies, Announced Aug. 4, 2011, [Site
Visited Apr. 13, 2016] <http://dhoodies.net/sleeveless-hoodie>.*

* cited by examiner

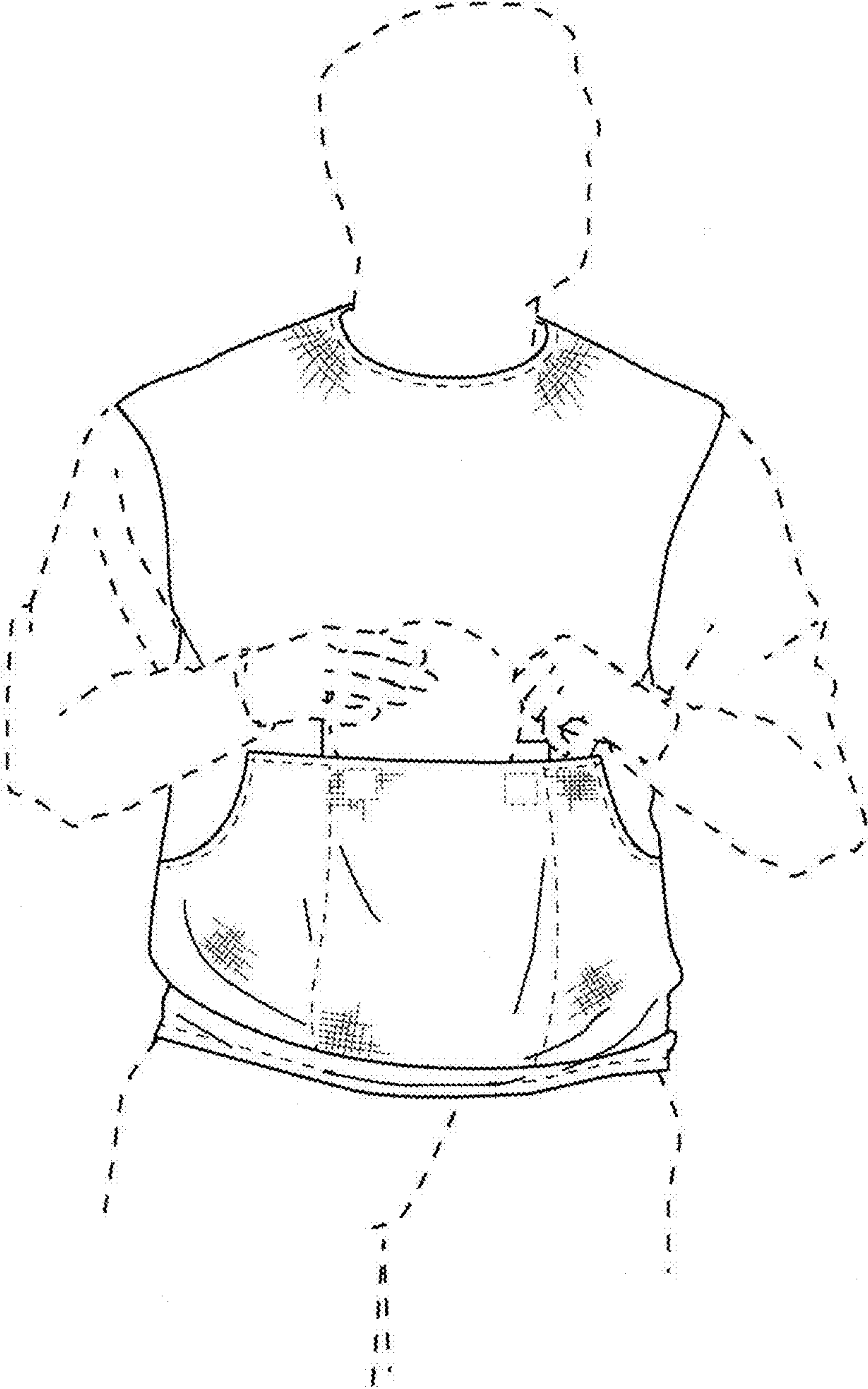

FIG. 1

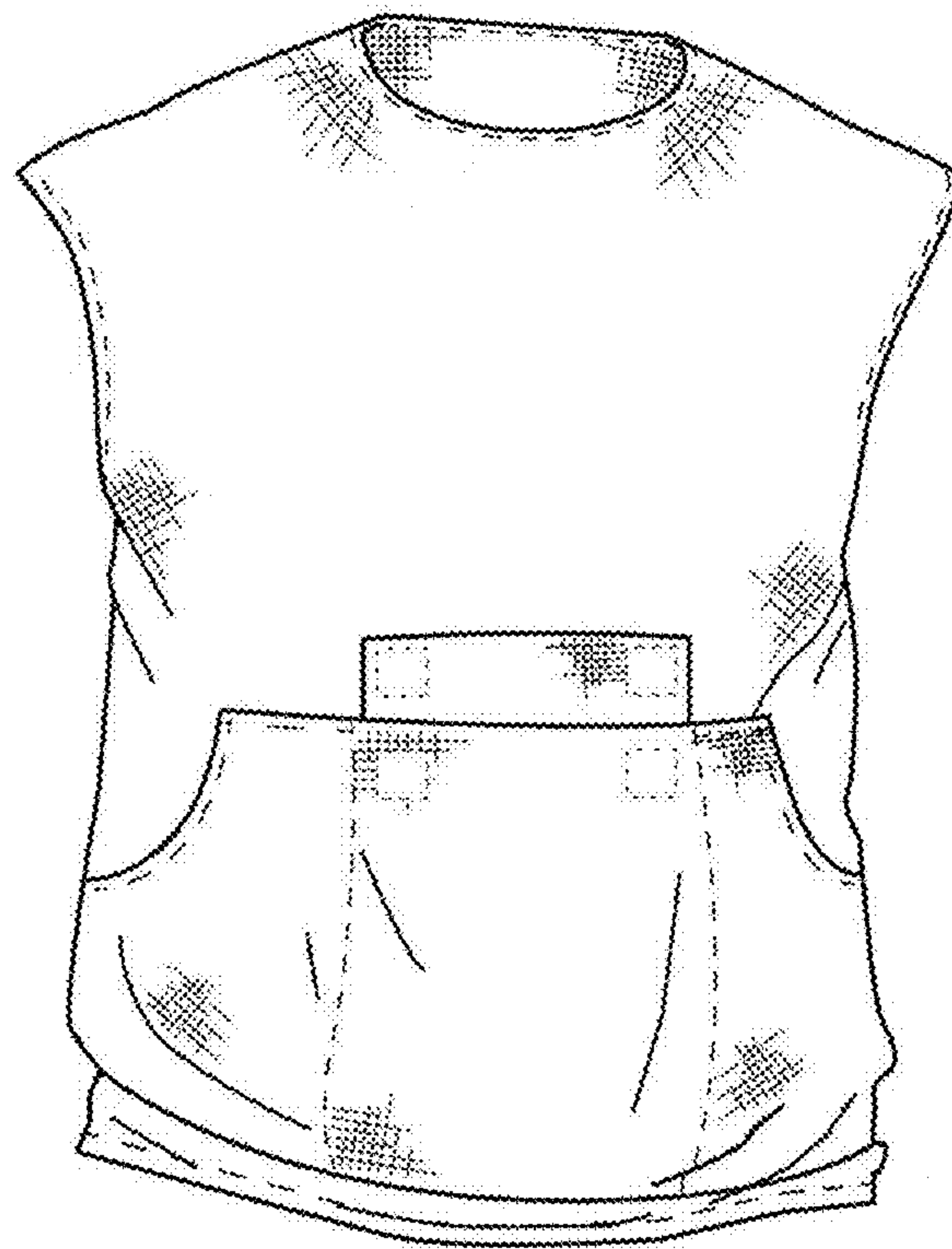

FIG. 2

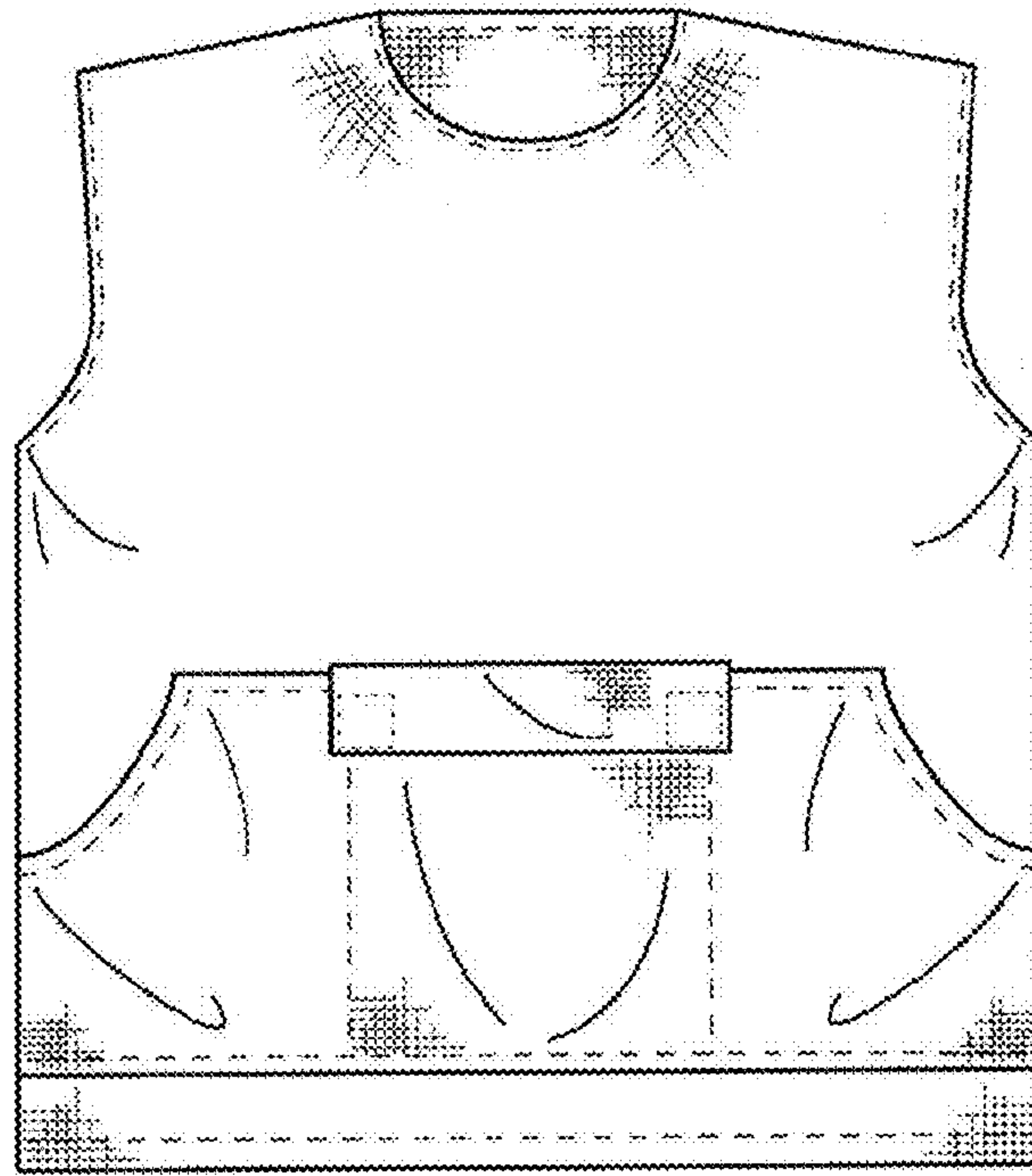

FIG. 3

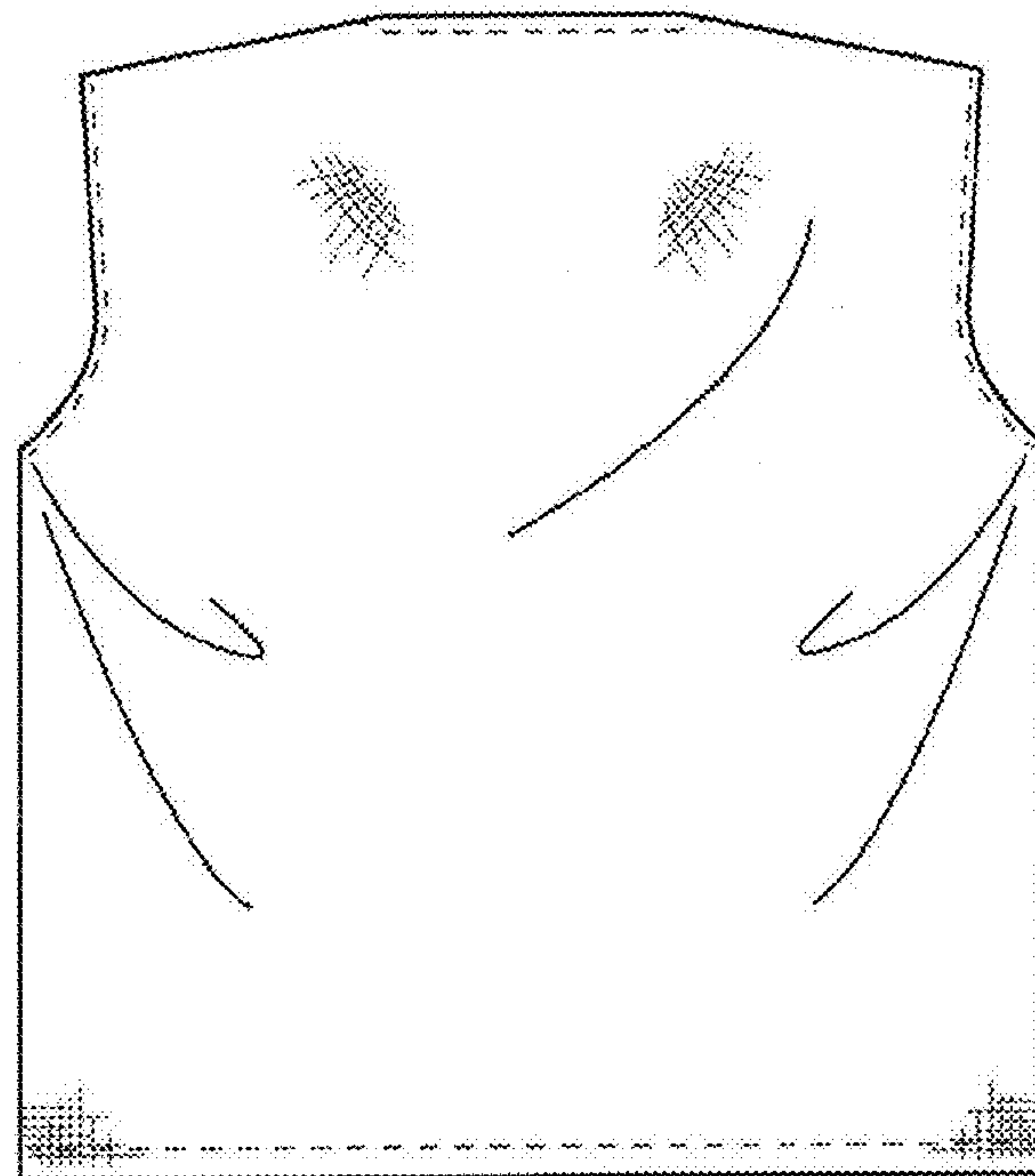

FIG. 4

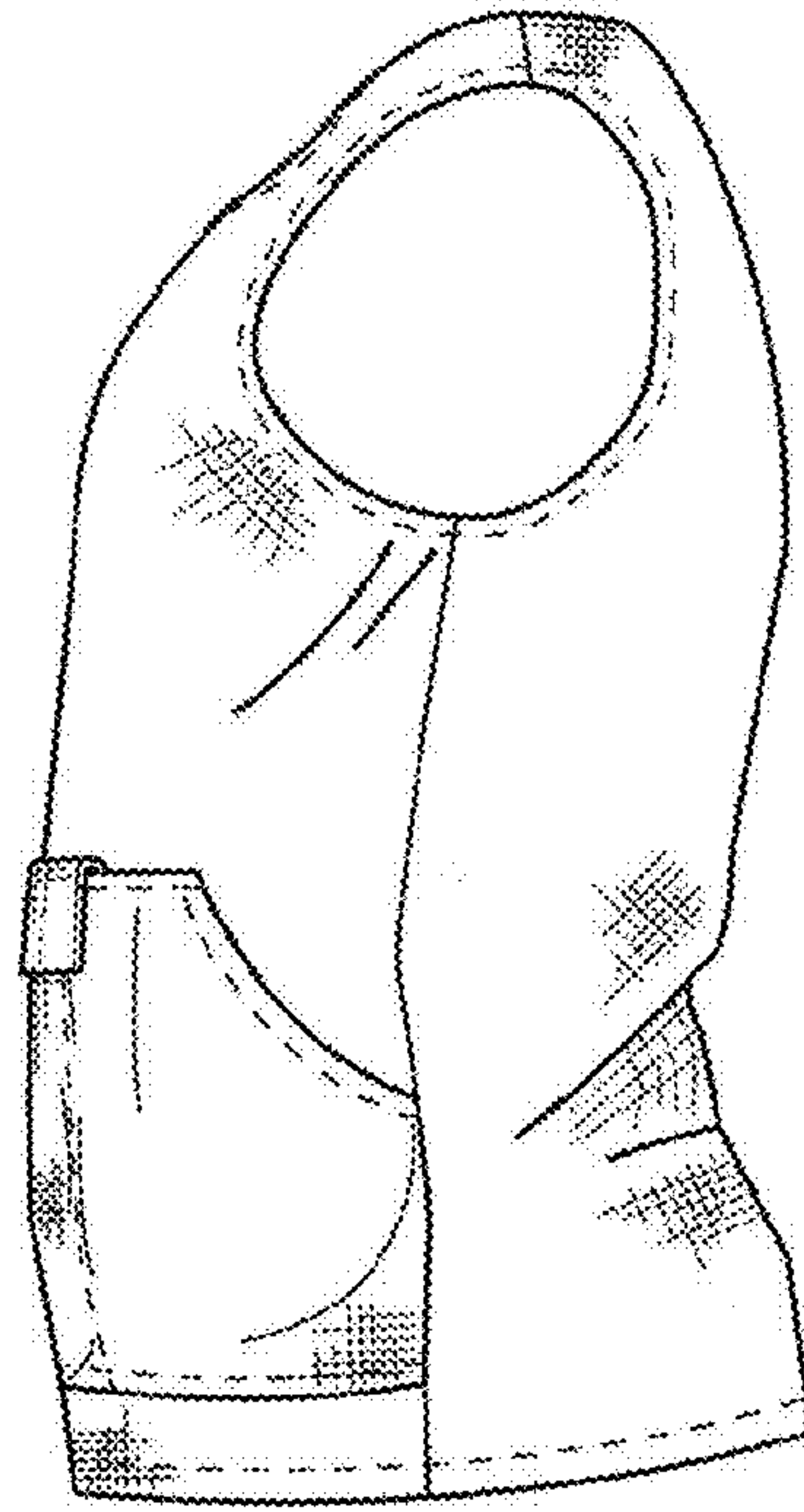

FIG. 5

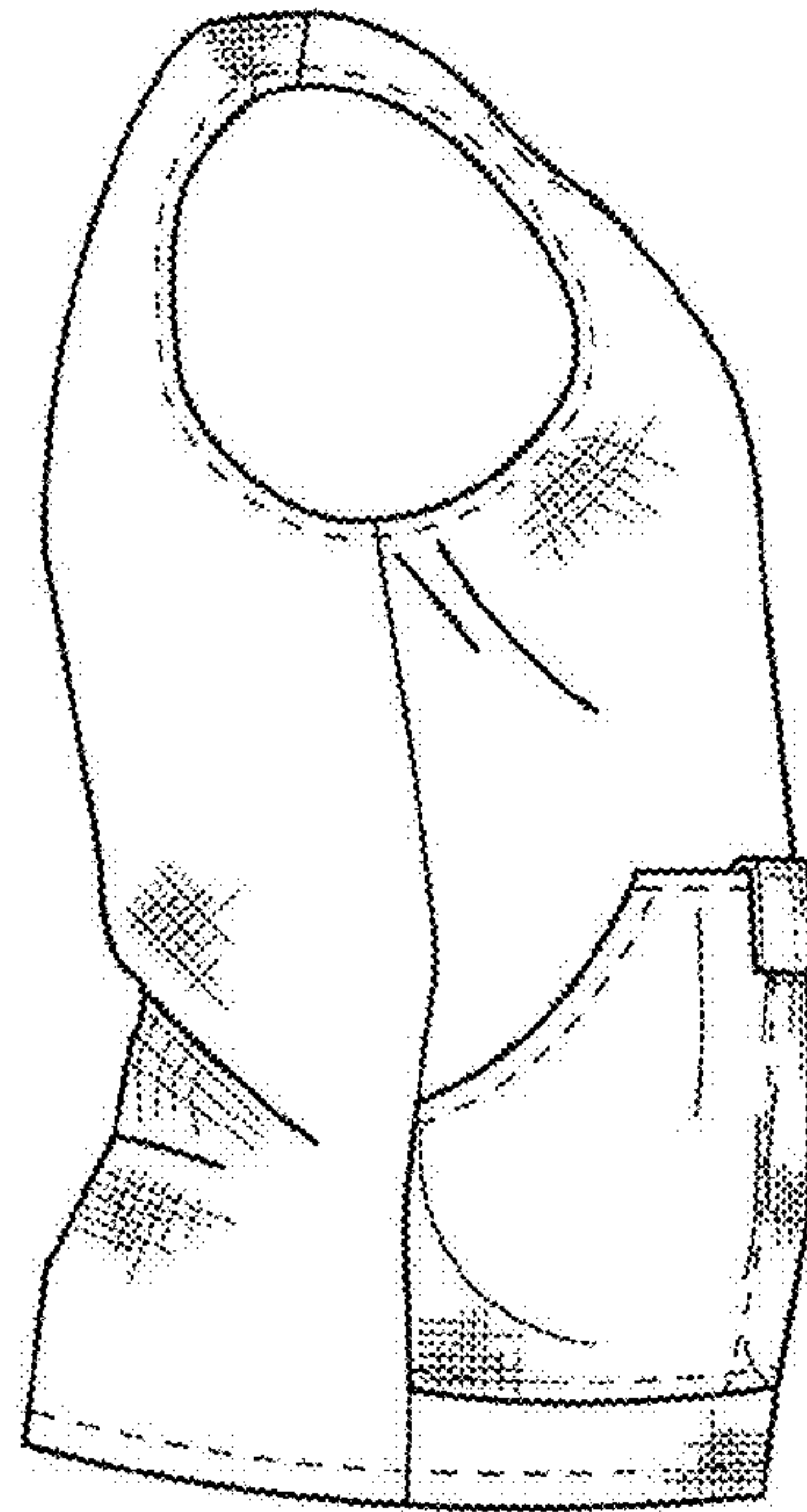

FIG. 6

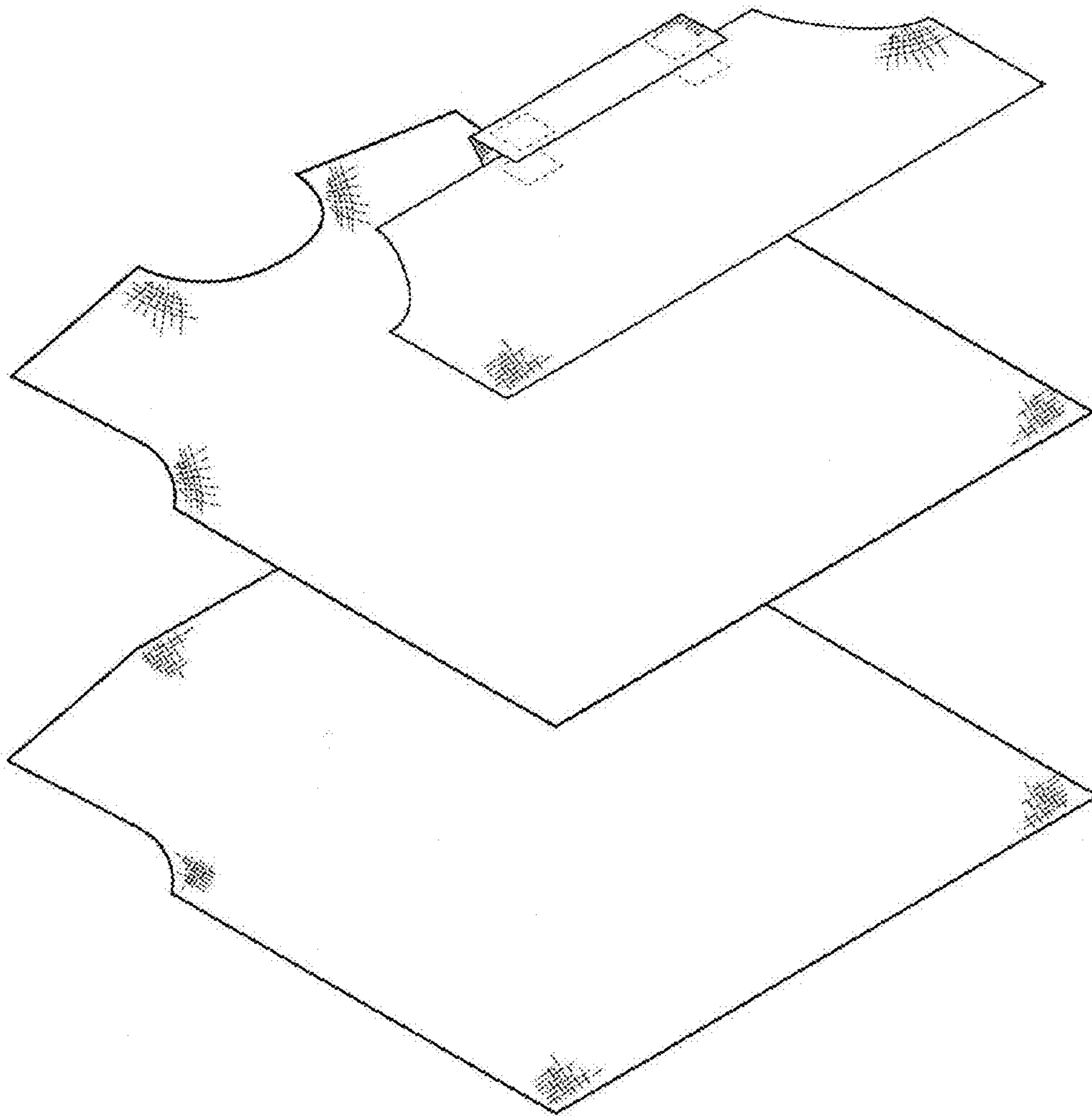

FIG. 7