



US00D767158S

(12) **United States Design Patent**
Wang et al.

(10) **Patent No.:** **US D767,158 S**
(45) **Date of Patent:** **** Sep. 20, 2016**

- (54) **RAPID TEST CUP**
- (71) Applicant: **ALFA SCIENTIFIC DESIGNS, INC.**,
Poway, CA (US)
- (72) Inventors: **Naishu Wang**, Poway, CA (US);
Michael Chang-Chien, Cerritos, CA
(US)
- (73) Assignee: **ALFA SCIENTIFIC DESIGNS, INC.**,
Poway, CA (US)
- (**) Term: **15 Years**
- (21) Appl. No.: **29/545,546**
- (22) Filed: **Nov. 13, 2015**
- (51) **LOC (10) Cl.** **24-02**
- (52) **U.S. Cl.**
USPC **D24/223; D24/224**
- (58) **Field of Classification Search**
USPC D24/121, 216, 222-232; D10/78, 81,
D10/103; 422/408, 430, 501-504, 68.1,
422/547, 67, 412, 417, 537, 562; 436/163,
436/164, 169, 518; 435/6.16, 91.1, 6.11,
435/287.1, 287.2, 7.1, 7.9, 32; 600/300,
600/583-584; 356/440, 445
CPC . B01J 19/0046; C12M 23/22; A61B 10/007;
A61B 10/0096; B01L 3/502; B01L
2400/0406; B01L 2300/0816; B01L
3/502707; B01L 3/5025; B01L 3/5023;
G01N 33/528; G01N 21/07; G01N 33/558;
G01N 33/54366; G01N 21/474; G01N
21/278
See application file for complete search history.

(56) **References Cited**

U.S. PATENT DOCUMENTS

- D249,708 S * 9/1978 Smith D24/224
- 4,778,758 A * 10/1988 Ericsson C12M 23/22
435/287.9
- 5,403,551 A * 4/1995 Galloway A61B 10/007
422/417

- D367,114 S * 2/1996 Wilson D24/224
- 5,976,895 A * 11/1999 Cipkowski A61B 10/007
422/412
- D435,906 S * 1/2001 Wilkinson D24/216
- 6,548,019 B1 4/2003 Lee et al.
- 6,616,893 B1 * 9/2003 Pham G01N 33/528
422/430
- 6,730,268 B2 * 5/2004 Lee A61B 10/0096
422/420
- D494,279 S * 8/2004 Cogan D24/121
- 6,805,838 B2 * 10/2004 Tydings G01N 33/558
422/412
- D520,643 S * 5/2006 Clarke D24/216
- D527,463 S * 8/2006 Py D24/224
- 7,300,633 B2 * 11/2007 Hudak B01L 3/502
422/537
- 7,438,852 B2 * 10/2008 Tung A61B 10/007
422/562
- 7,550,112 B2 * 6/2009 Gou A61B 10/007
422/562

(Continued)

Primary Examiner — T. Chase Nelson

Assistant Examiner — Mark Cavanna

(74) *Attorney, Agent, or Firm* — A. Lindeman & Co., PLLC

(57) **CLAIM**

The ornamental design for a rapid test cup, as shown and described.

DESCRIPTION

FIG. 1 is a front perspective view of a rapid test cup showing our new design;
 FIG. 2 is a left side view of a rapid test cup of FIG. 1;
 FIG. 3 is a right side view of a rapid test cup of FIG. 1;
 FIG. 4 is a rear view of a rapid test cup of FIG. 1;
 FIG. 5 is a front side view of a rapid test cup of FIG. 1;
 FIG. 6 is a top view of a rapid test cup of FIG. 1;
 FIG. 7 is a bottom view of a rapid test cup of FIG. 1;
 FIG. 8 is an exploded view of the rapid test cup of FIG. 1;
 and,
 FIG. 9 is a side elevational perspective view of the rapid test cup shown in vertical cross sectional along the longitudinal axis.

1 Claim, 6 Drawing Sheets

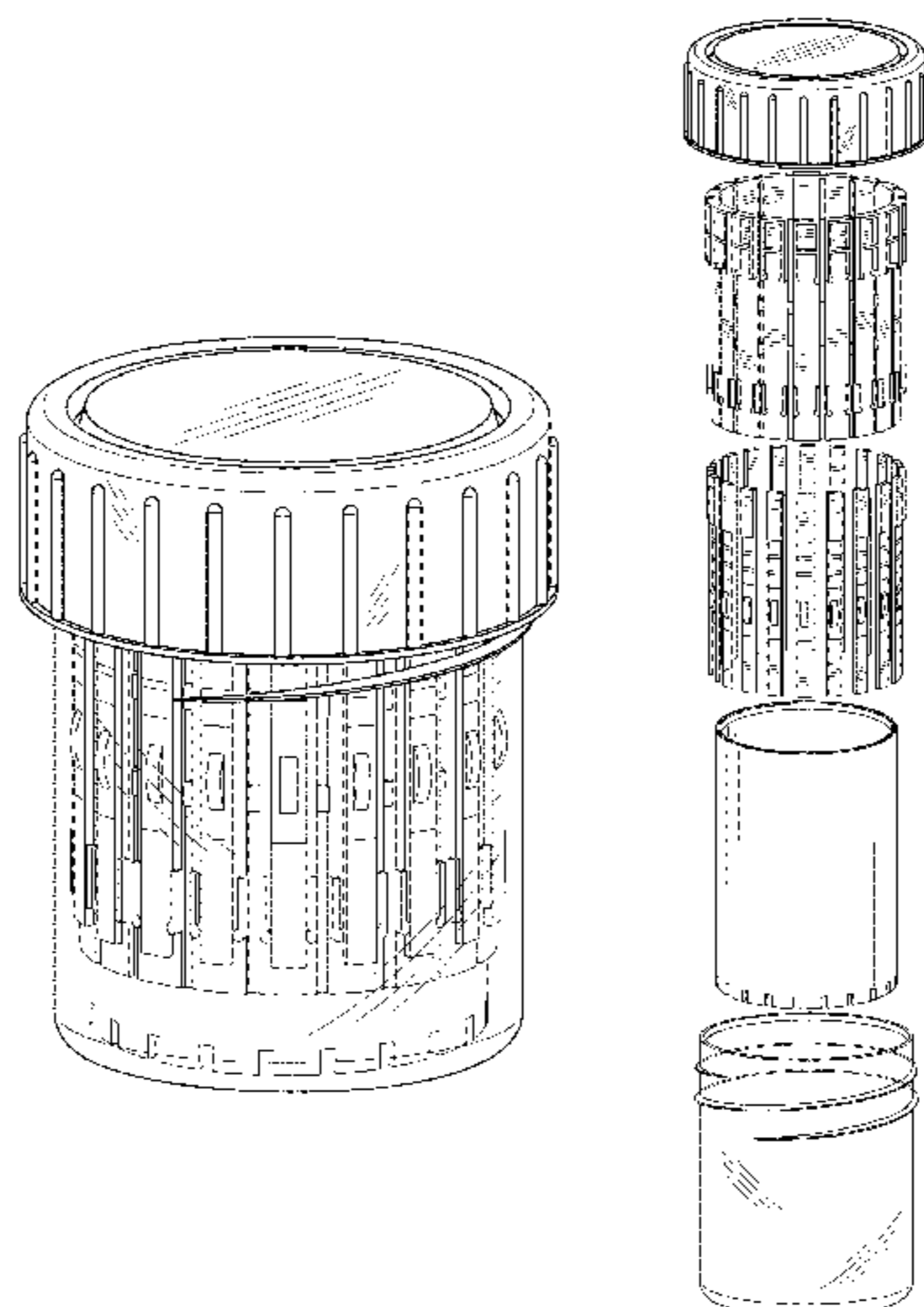

US D767,158 S

Page 2

(56)

References Cited

U.S. PATENT DOCUMENTS

D610,254 S * 2/2010 Huff D24/121
D620,590 S * 7/2010 Wan D24/121
D627,479 S * 11/2010 Cofie D24/224
D651,322 S * 12/2011 Svard D24/224
D659,847 S * 5/2012 Li D24/216
D690,826 S * 10/2013 Kuroda D24/224

D726,929 S * 4/2015 Wainwright D24/224
2002/0085953 A1 * 7/2002 Parker A61B 10/007
422/412
2003/0099572 A1 * 5/2003 Ng B01L 3/502
422/417
2005/0032234 A1 * 2/2005 Ramsey A61B 5/20
422/400
2005/0106750 A1 * 5/2005 Tung A61B 10/007
422/562

* cited by examiner

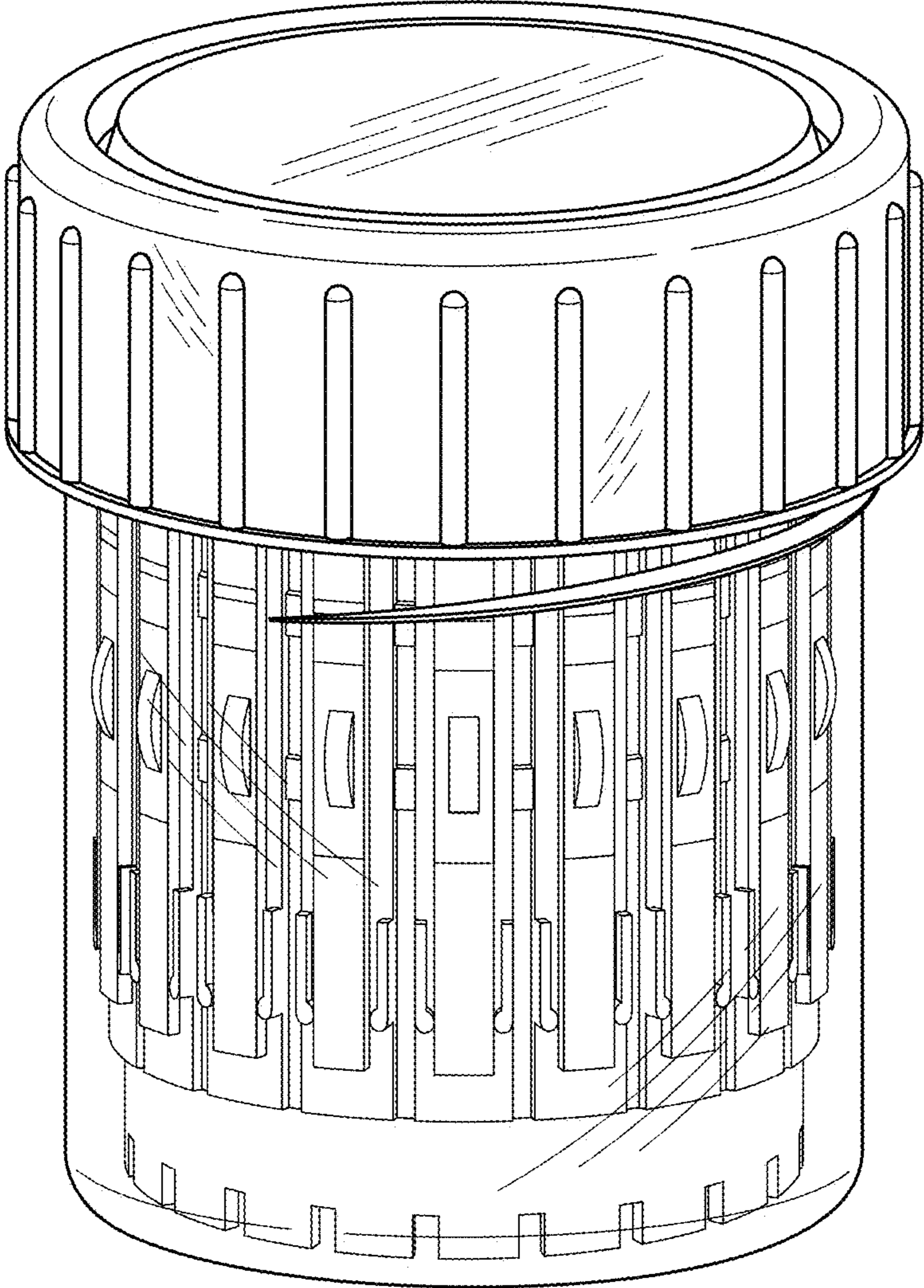

FIG. 1

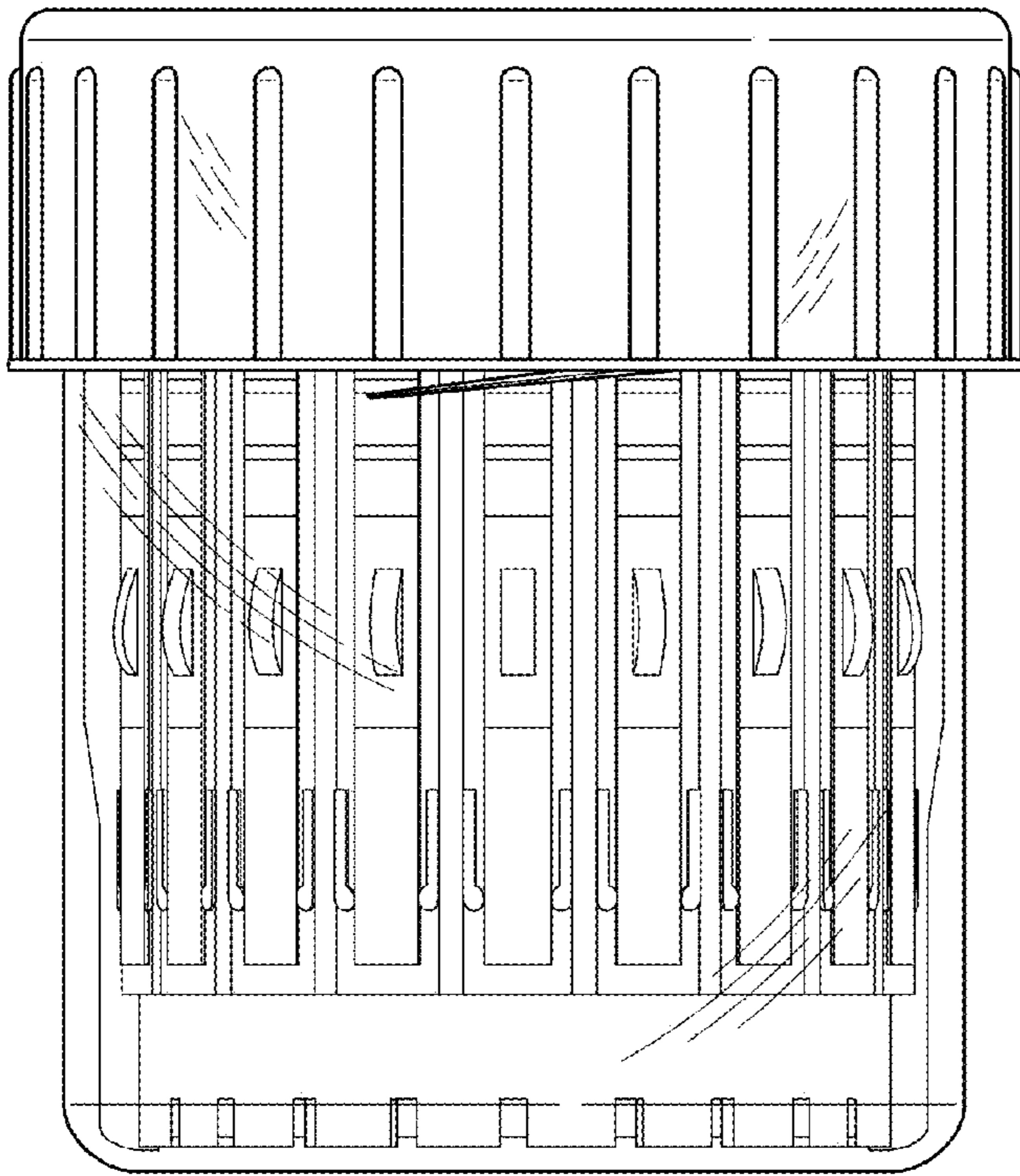

FIG. 2

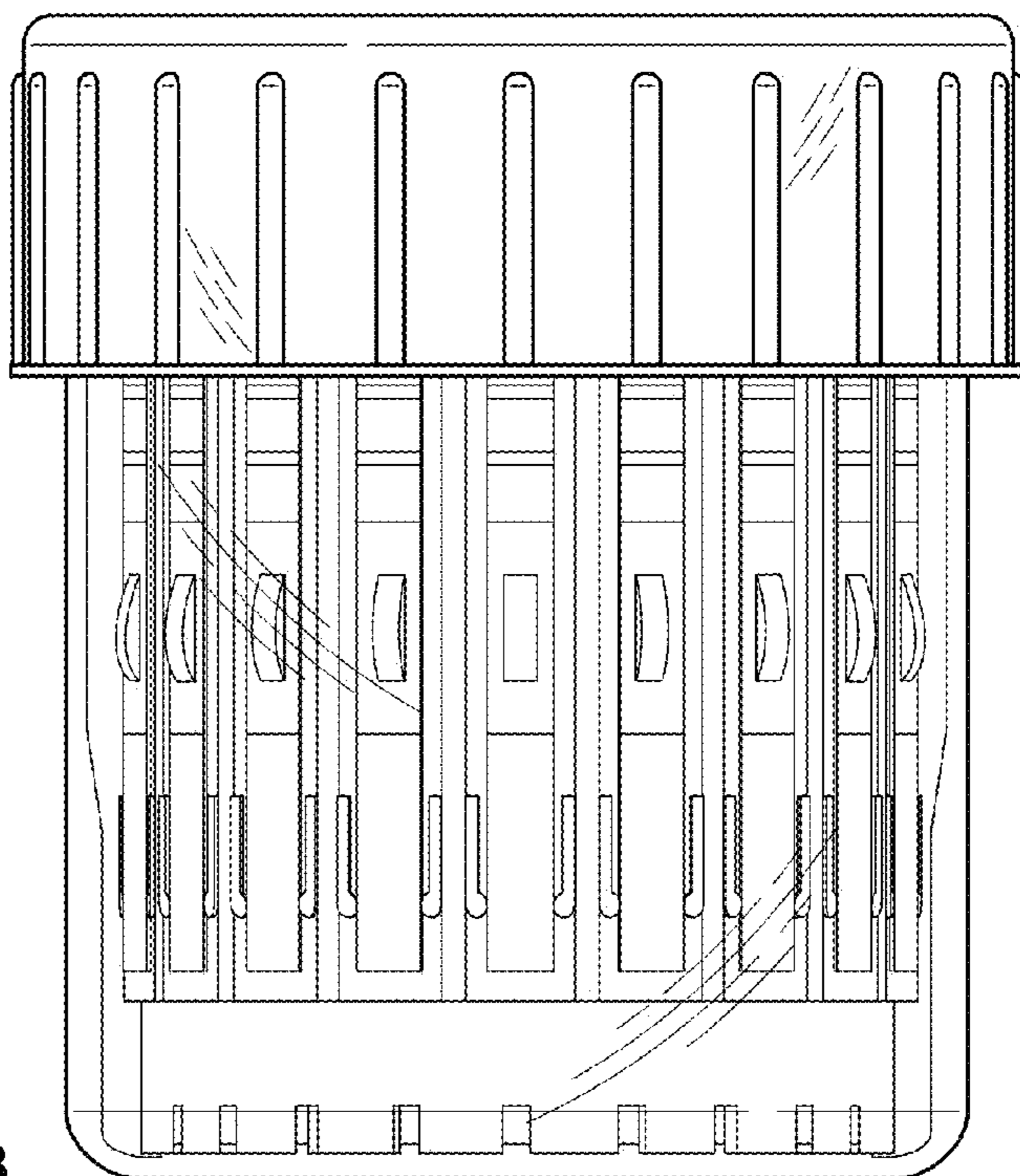

FIG. 3

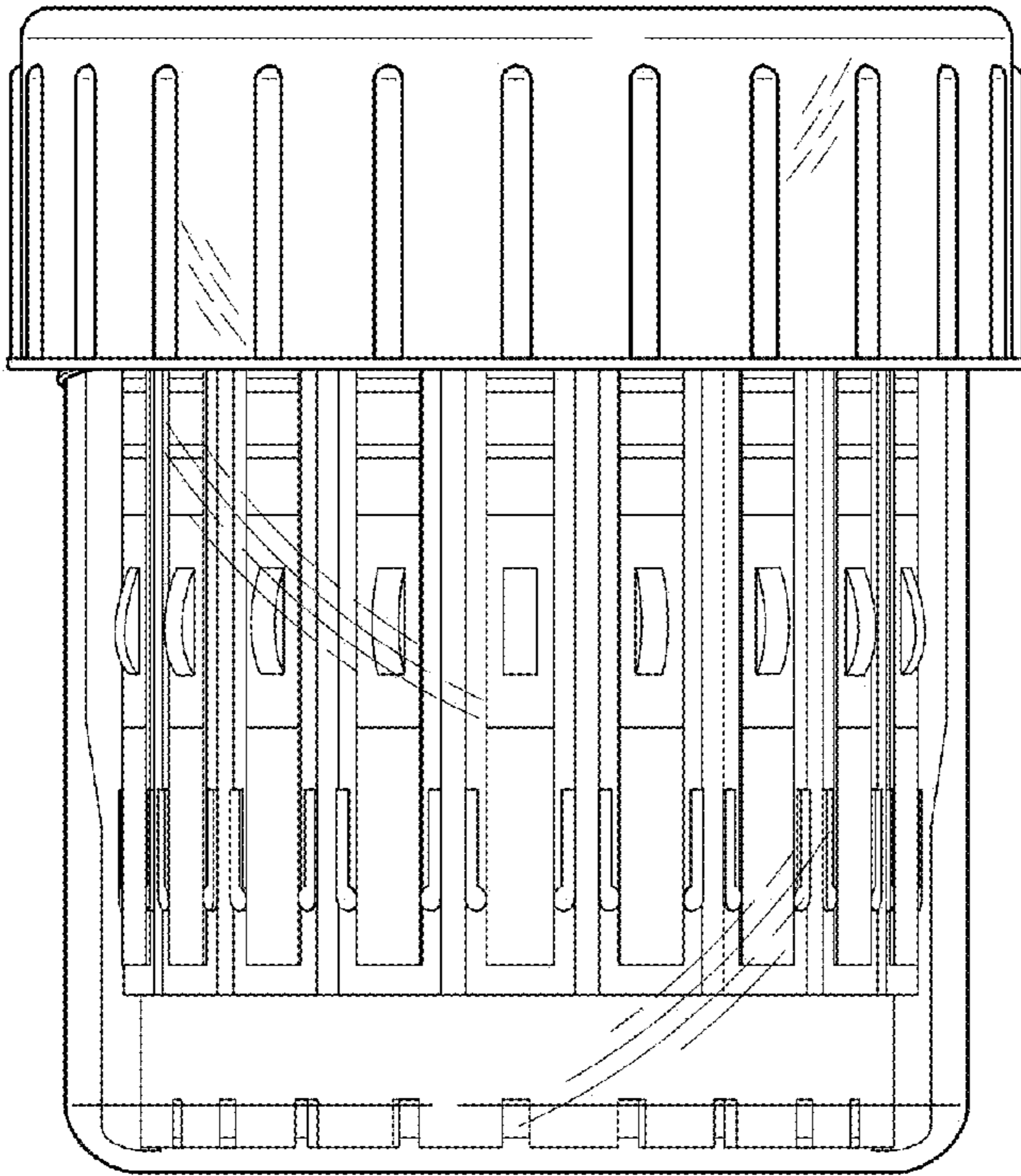

FIG. 4

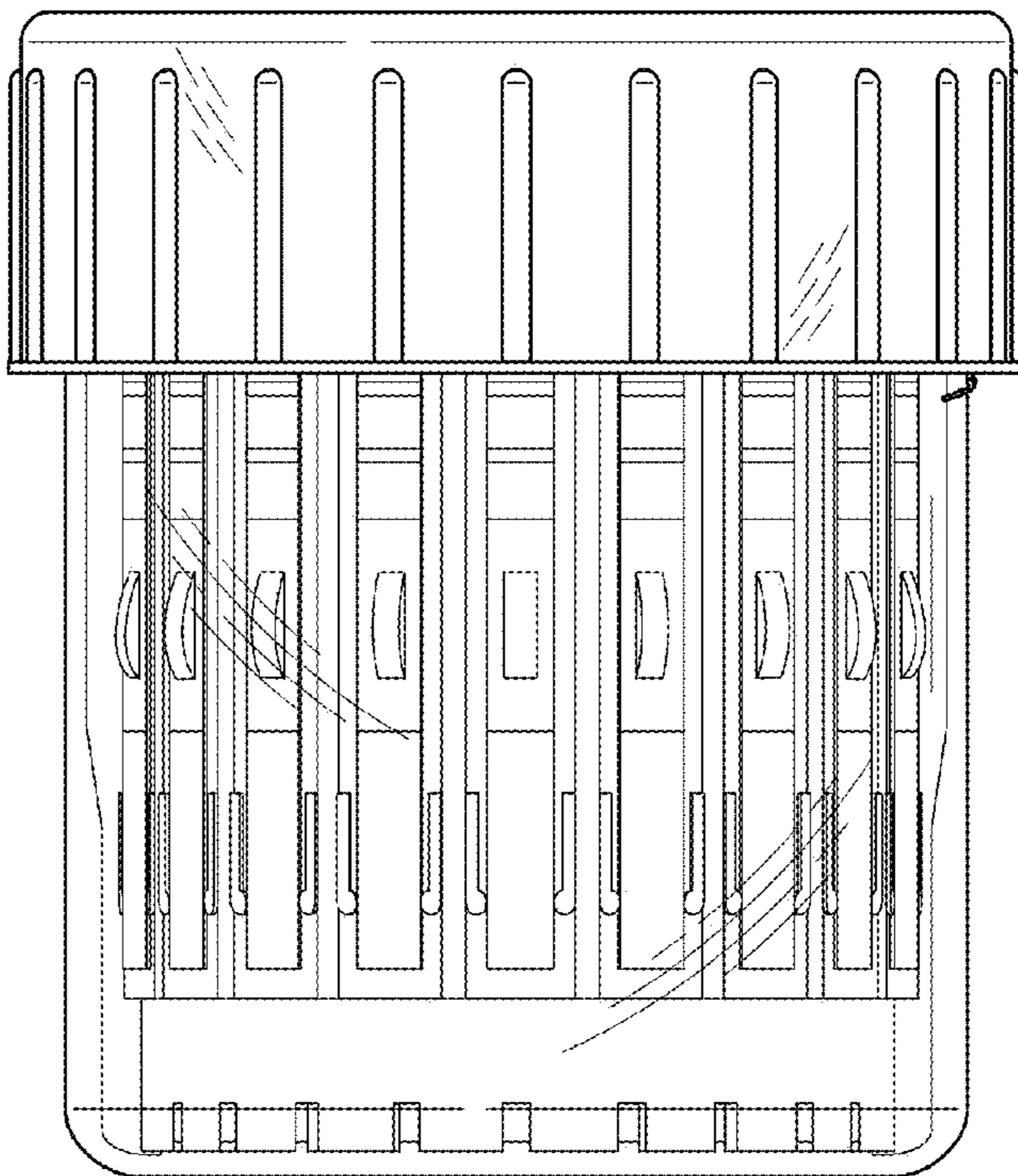

FIG. 5

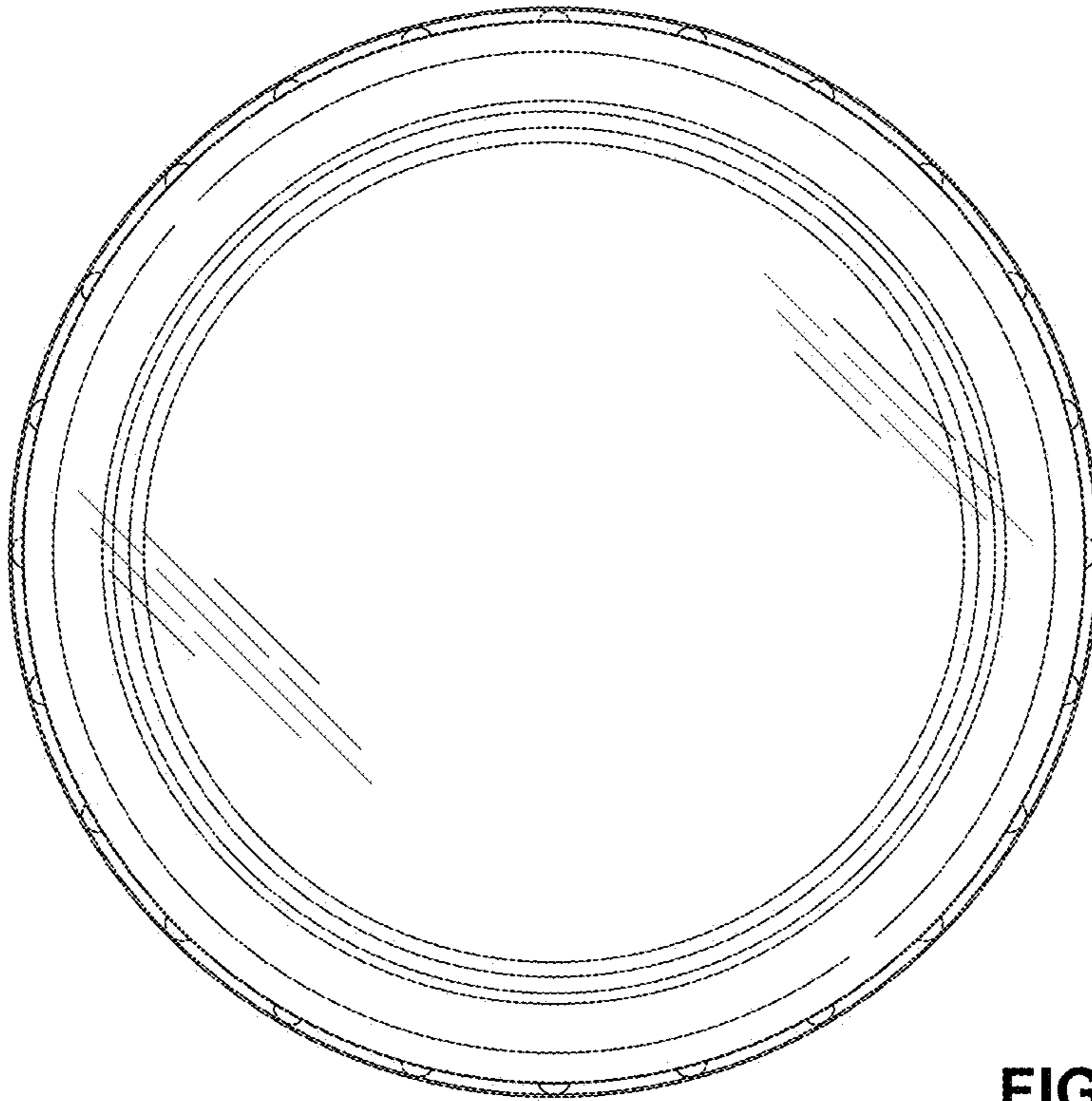

FIG. 6

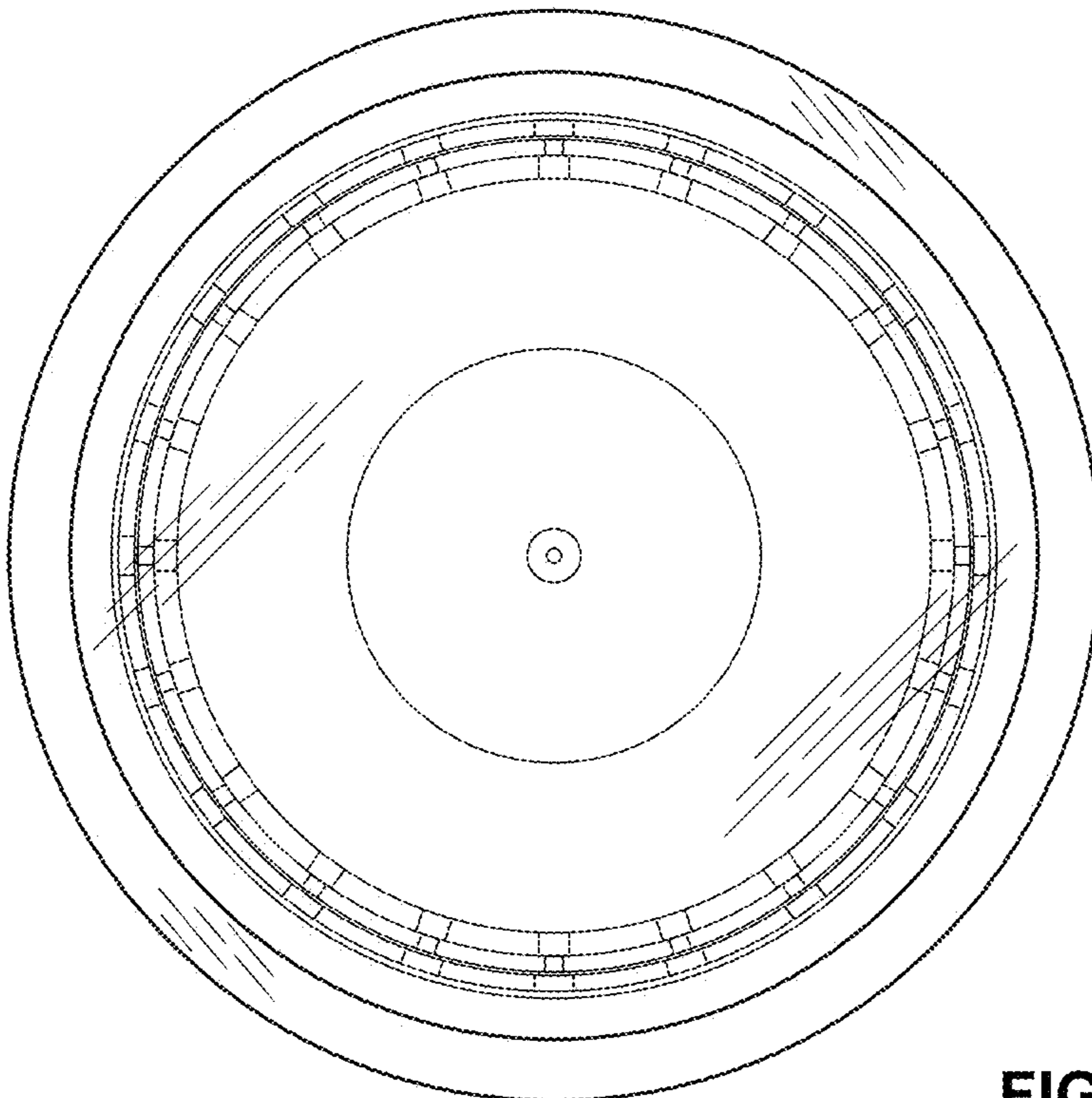

FIG. 7

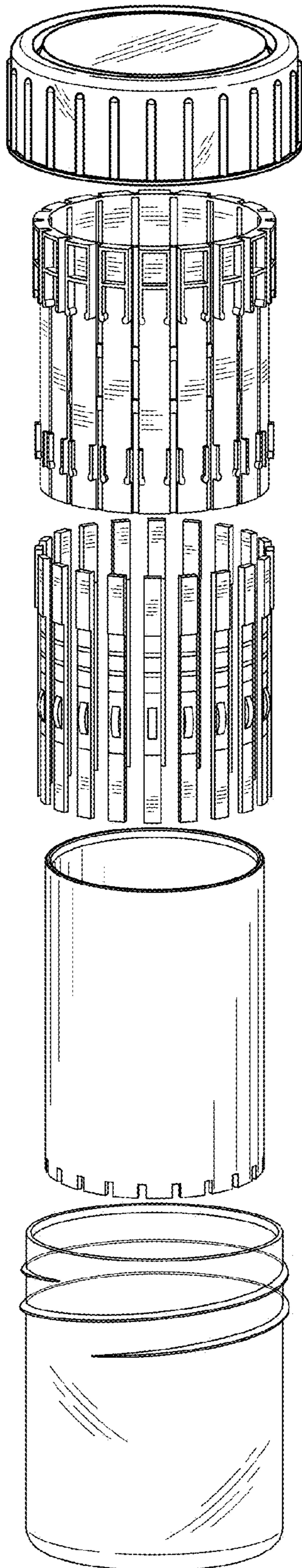

FIG. 8

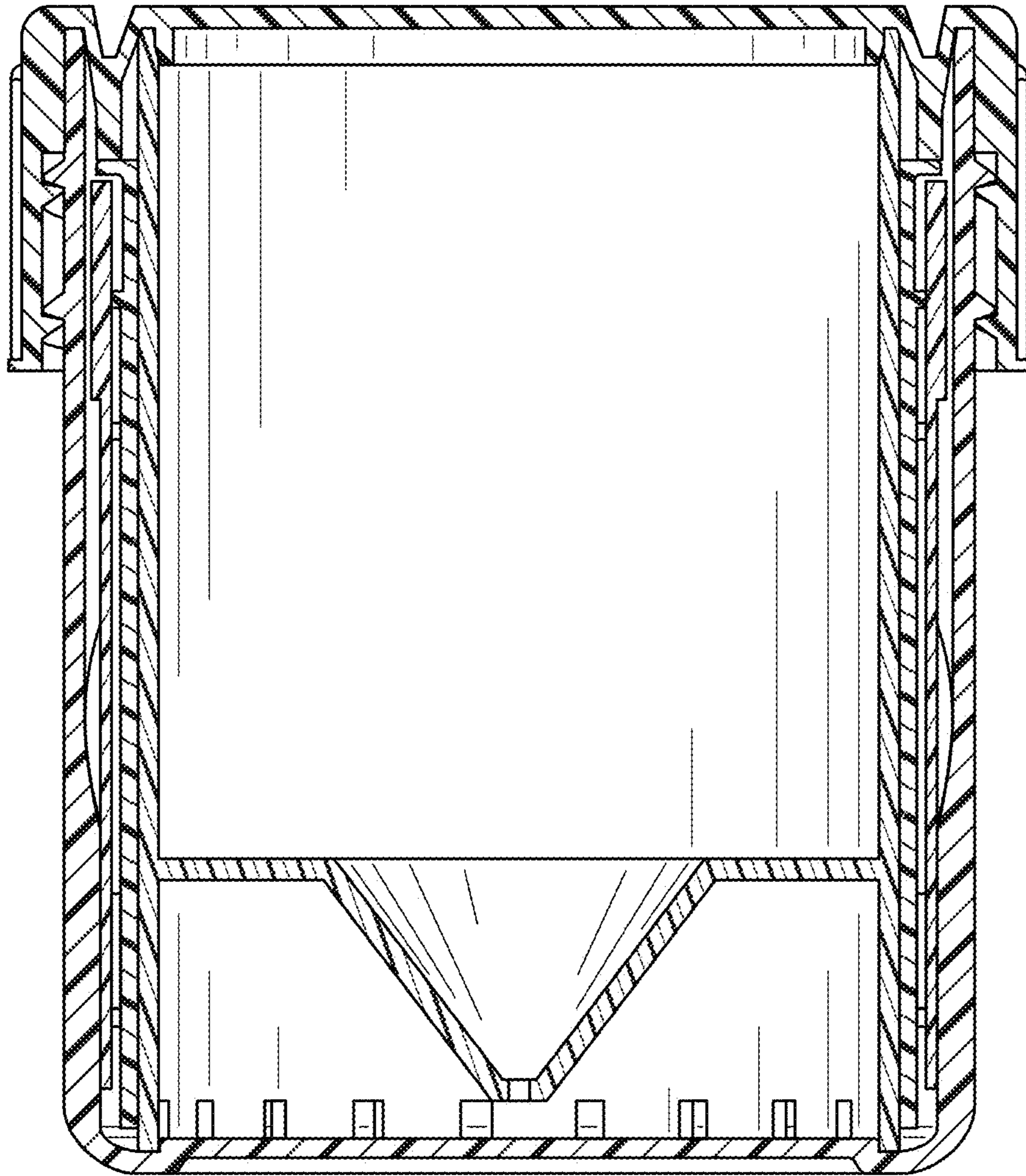

FIG. 9