



US00D767119S

(12) **United States Design Patent** (10) **Patent No.:** **US D767,119 S**
Hauck et al. (45) **Date of Patent:** **** *Sep. 20, 2016**

(54) **AUTOINJECTOR**

(71) Applicant: **Sanofi**, Paris (FR)

(72) Inventors: **Claudia Hauck**, Paris (FR); **Helene Capgras**, Paris (FR); **Noriko Hattori**, Tokyo (JP); **Cristina Fernandez**, Paris (FR)

(73) Assignee: **Sanofi**, Paris (FR)

(*) Notice: This patent is subject to a terminal disclaimer.

(**) Term: **14 Years**

(21) Appl. No.: **29/525,513**

(22) Filed: **Apr. 30, 2015**

(51) **LOC (10) Cl.** **24-02**

(52) **U.S. Cl.**
USPC **D24/113**

(58) **Field of Classification Search**
USPC D24/112-114, 108, 133, 130, 127, 186;
606/181, 185; 604/264, 272, 187, 181,
604/184, 227
CPC A61M 5/178; A61M 3/00; A61M 5/20;
A61M 5/31; A61M 5/3146; A61M 5/3129;
A61M 5/3148; A61M 5/315
See application file for complete search history.

(56) **References Cited**

U.S. PATENT DOCUMENTS

D620,106 S *	7/2010	Van der Stappen	D24/113
D622,374 S *	8/2010	Julian	D24/113
D627,061 S *	11/2010	Van der Stappen	D24/113
D687,543 S *	8/2013	Pala	D24/113
D688,790 S *	8/2013	Guarraia	D24/113
D688,791 S *	8/2013	Guarraia	D24/113
D696,397 S *	12/2013	Guarraia	D24/113
D696,773 S *	12/2013	Schneider	D24/113
D696,774 S *	12/2013	Guarraia	D24/113

D697,205 S *	1/2014	Schneider	D24/113
D708,317 S *	7/2014	Schneider	D24/113
D714,932 S *	10/2014	Hall	D24/112
D715,422 S *	10/2014	Hall	D24/112

OTHER PUBLICATIONS

Examination Report in NZ Application No. 420861, dated Nov. 10, 2015, 2 pages.
Screenshots relating to "Auto Injector citations by SHL Group," publically visible from Dec. 30, 2014, 4 pages.
Design U.S. Appl. No. 29/525,514; Autoinjector Without Cap; Claudia Hauck et al.; filed Apr. 30, 2015.
Design U.S. Appl. No. 29/525,518; Autoinjector; Claudia Hauck et al.; filed Apr. 30, 2015.

(Continued)

Primary Examiner — David Muller

(74) *Attorney, Agent, or Firm* — Fish & Richardson P.C.

(57) **CLAIM**

The ornamental design for an autoinjector, as shown and described.

DESCRIPTION

The patent or application contains at least one drawing executed in color. Copies of this patent or patent application with color drawing(s) will be provided by the office upon request and payment of the necessary fee.

FIG. 1 is a front top left perspective view of an autoinjector showing our new design;
FIG. 2 is a front elevation view thereof;
FIG. 3 is a rear elevation view thereof;
FIG. 4 is a bottom plan view thereof;
FIG. 5 is a top plan view thereof;
FIG. 6 is a left side view thereof; and,
FIG. 7 is a right side view thereof.

The broken line showing of parts of the drawings is included for the purpose of illustrating use and environment and forms no part of the claimed design.

1 Claim, 4 Drawing Sheets
(4 of 4 Drawing Sheet(s) Filed in Color)

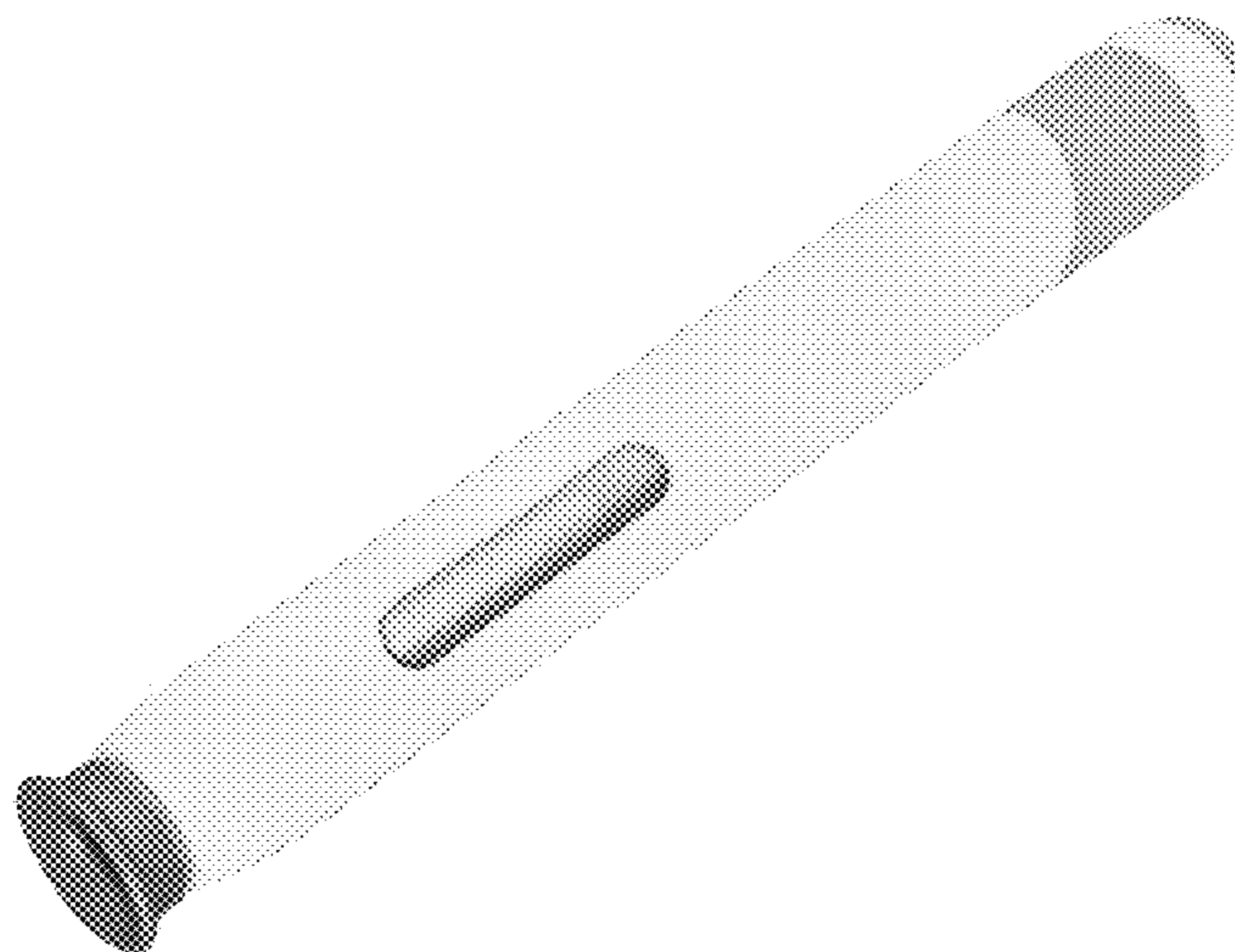

(56)

References Cited

OTHER PUBLICATIONS

Design U.S. Appl. No. 29/525,520 ; Autoinjector Without Cap; Claudia Hauck et al.; Apr. 30, 2015.

<http://www.pegasys.com/patient/on-treatment/how-to-take-pegasys/pegasys-proclick-autoinjector/>; Data Sheet for Pegasys ProClick Autoinjector; accessed Apr. 21, 2015.

<http://sumainject.mobi/page/5/>; Sun Pharma Sumatriptan Injection Refill Reminders email contact page; accessed Apr. 21, 2015.

http://www.takeda.com/news/2013/20130610_5815.html; Takeda; Apr.-Jun. 2013 Newsroom Release Jun. 10, 2013; Pfizer Japan and Takeda Launch “Enbrel Subcutaneous Injection 50mg Pen 1.0mL”, New Method of Administration for Rheumatoid Arthritis Treatment Enbrel; accessed Apr. 21, 2015.

<http://www.shl-group.com/product/dai-rns-auto-injector/>; Data Sheet for SHL Group Medical Products DAI-RNS Auto Injector; accessed Apr. 21, 2015.

<http://www.shl-group.com/product/dai-auto-injector/> Data Sheet for SHL Group Medical Products DAI AutoInjector; accessed Apr. 21, 2015.

http://www.pharmaceutical-technology.com/contractors/drug_delivery/shl-group/shl-group2.html; Pharmaceutical-Technology.com; SHL Group; SHL-Autoinjectors, Pen Injectors and Inhaler Systems; Accessed Apr. 21, 2015.

http://www.tiskl.org.cn/images/czabe180-pz2017a03-dai_rns_auto_injector.html; Webpage—Contact Us Section; accessed Apr. 21, 2015.

<http://www.shl-group.com/product/dai-auto-injector-trainer/>; Data Sheet for SHL Group Medical Products DAI Auto Injector Trainer; accessed Apr. 21, 2015.

<http://tommythematerialgirl.blogspot.com/2013/06/a-little-prick.html>; Tommy the Material Girl blog page; A Little Prick; accessed Apr. 21, 2015.

http://www.isips.org/page/safety_products/autoinjection_syringe; Information Page for ISIPS; Autoinjection Syringe; accessed Apr. 21, 2015.

http://www.2care.nl/aranesp_en_aranesp_sureClick.html; Amgen Araneso en Aranesp SureClick; accessed Apr. 21, 2015.

<http://www.drug3k.com/imagepages/12771/image10.html>; Data Sheet for Aranesp Darbeoetin Alfa—Inj SureClick Autoinjector (USA); accessed Apr. 21, 2015.

* cited by examiner

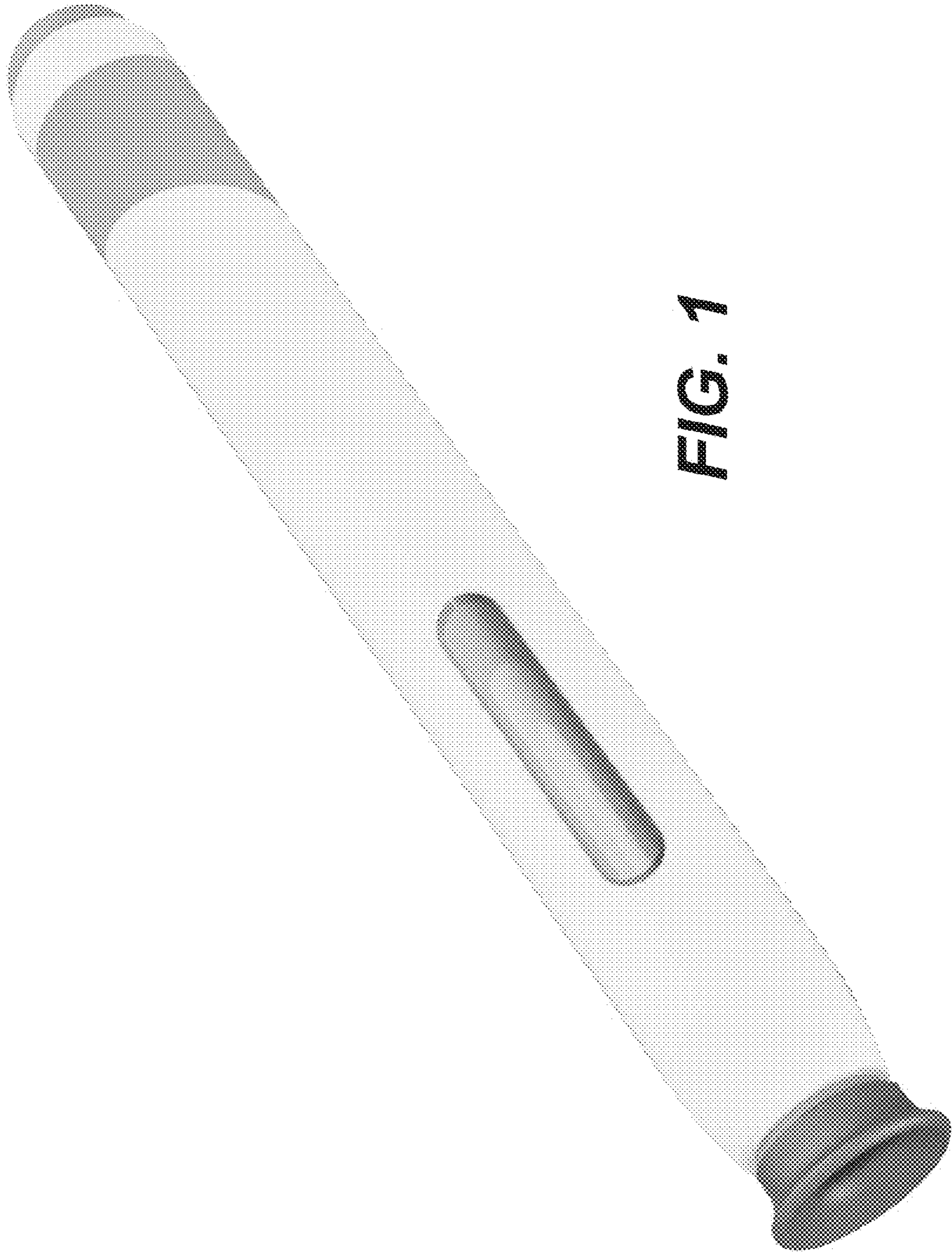

FIG. 1

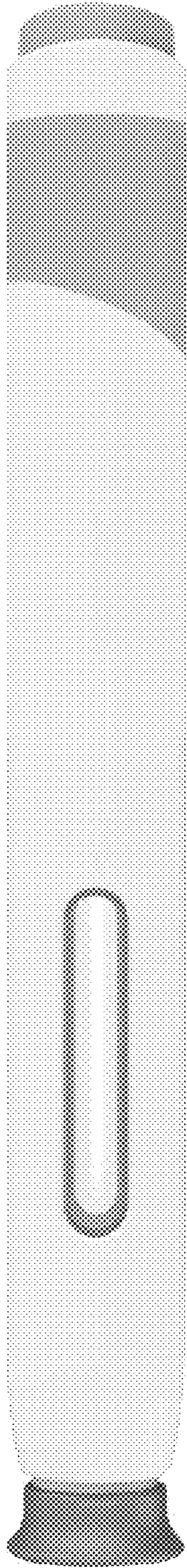

FIG. 2

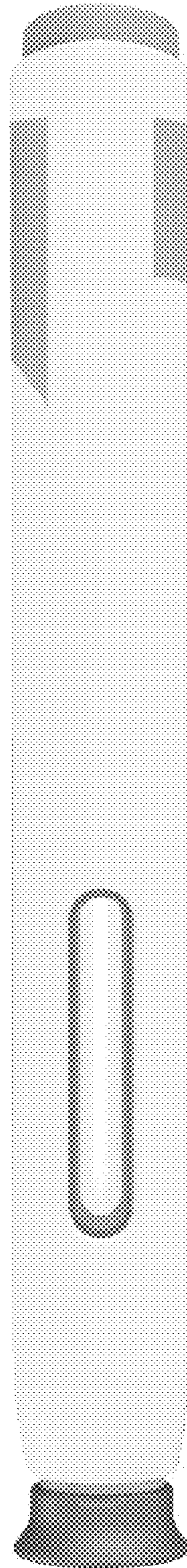

FIG. 3

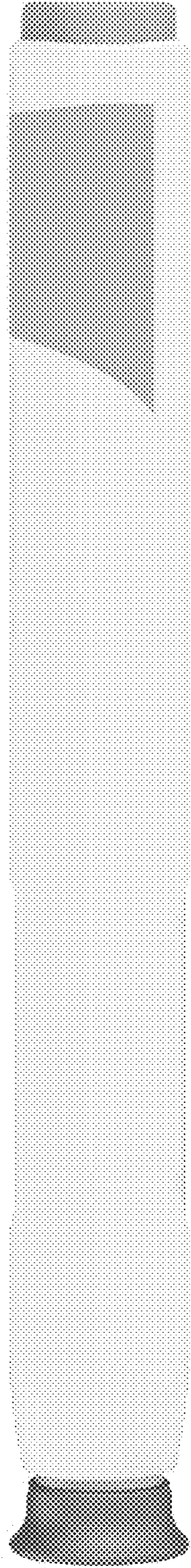

FIG. 4

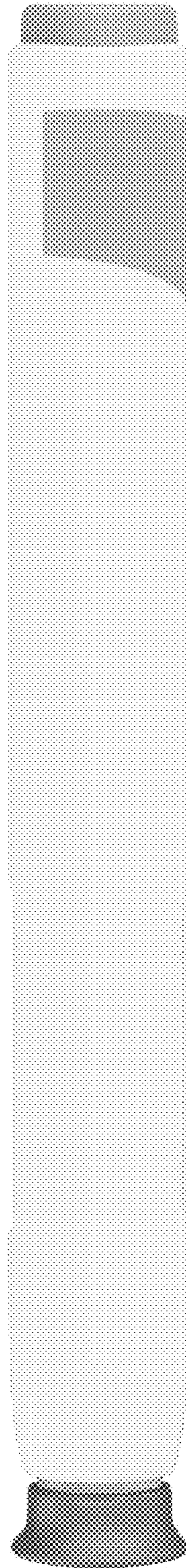

FIG. 5

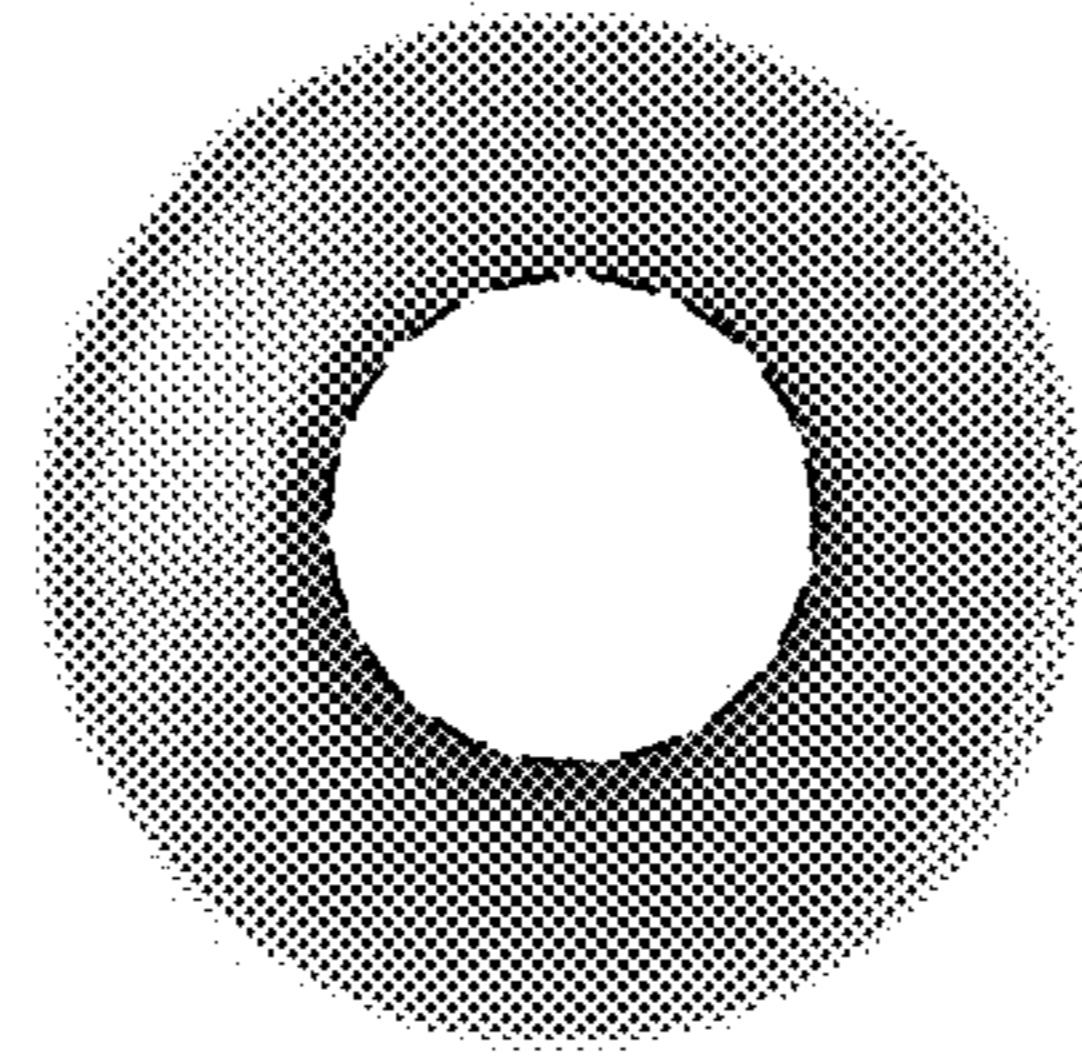

FIG. 6

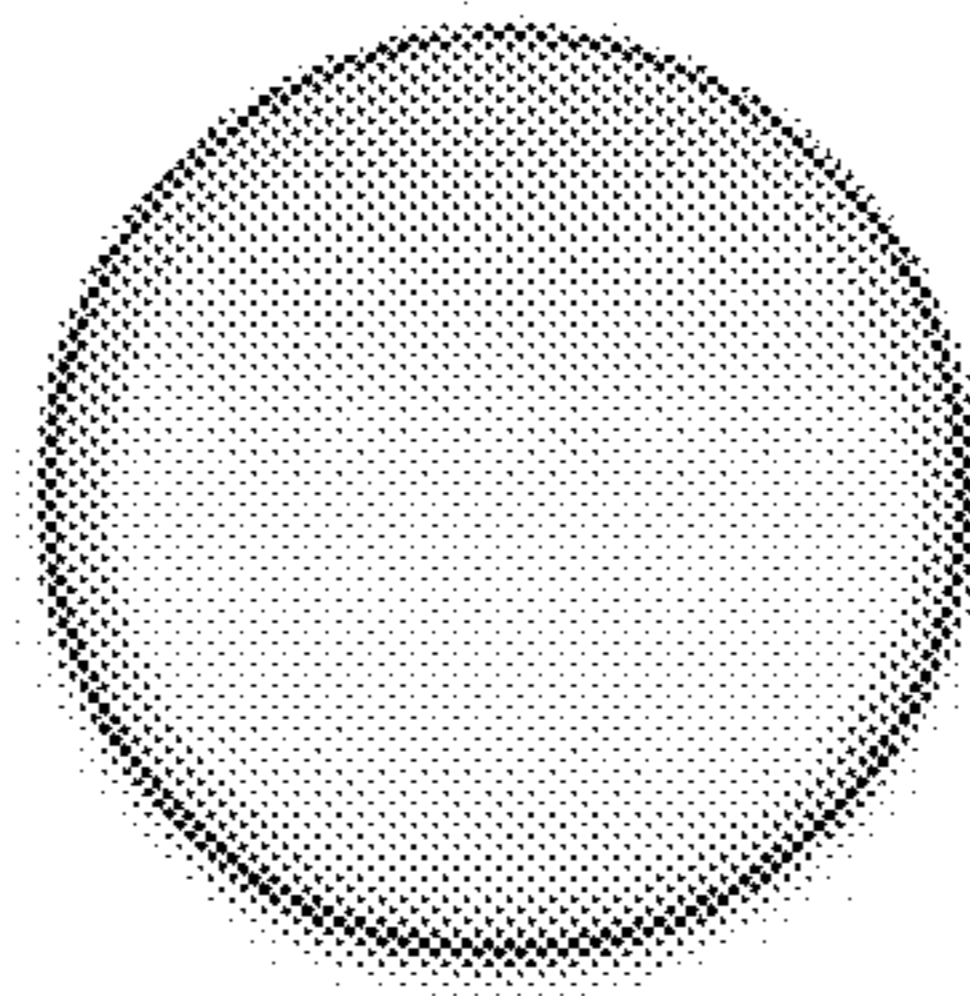

FIG. 7