



US00D767061S

(12) **United States Design Patent** (10) **Patent No.:** **US D767,061 S**
Stoelting (45) **Date of Patent:** **** Sep. 20, 2016**

(54) **GOLF CLUB HEAD COVER**
(71) Applicant: **Scott Stoelting**, Lawrenceburg, IN (US)
(72) Inventor: **Scott Stoelting**, Lawrenceburg, IN (US)
(**) Term: **14 Years**
(21) Appl. No.: **29/509,709**
(22) Filed: **Nov. 20, 2014**
(51) **LOC (10) Cl.** **21-02**
(52) **U.S. Cl.**
USPC **D21/754**
(58) **Field of Classification Search**
USPC D21/754; D11/131, 157; D9/439;
D7/387, 397
CPC A63B 60/62
See application file for complete search history.

D417,899 S * 12/1999 Sloan D21/623
6,113,457 A * 9/2000 Kociemba A63B 60/62
150/160
D443,666 S * 6/2001 Perry D21/754
D456,473 S * 4/2002 Okamoto D21/754
D465,536 S * 11/2002 Pontiff D21/754
D465,821 S * 11/2002 Pontiff D21/754
D466,172 S * 11/2002 Pontiff D21/754
D466,568 S * 12/2002 Pontiff D21/754
D466,571 S * 12/2002 Pontiff D21/754
D466,572 S * 12/2002 Pontiff D21/754
D468,384 S * 1/2003 Harkins D21/754
D470,207 S * 2/2003 Pontiff D21/754
D472,951 S * 4/2003 Sullivan D21/754
D490,130 S * 5/2004 Hung D21/754
D506,519 S * 6/2005 McCabe D21/754
D508,100 S * 8/2005 McCabe D21/754
D516,150 S * 2/2006 McCabe D21/754
D516,151 S * 2/2006 Murata D21/754
D517,627 S * 3/2006 McCabe D21/754

(Continued)

Primary Examiner — Mitchell Siegel
(74) *Attorney, Agent, or Firm* — Jenei LLC

(56) **References Cited**
U.S. PATENT DOCUMENTS

D191,270 S * 9/1961 Serbin D11/131
D287,392 S * 12/1986 Brittner D21/754
D301,047 S * 5/1989 Pace D21/754
D312,289 S * 11/1990 Pace D21/754
D395,694 S * 6/1998 Perry D21/754
D396,259 S * 7/1998 Pollard D21/754
D396,514 S * 7/1998 Perry D21/754
D397,181 S * 8/1998 Pollard D21/754
D397,182 S * 8/1998 Pollard D21/754
D397,183 S * 8/1998 Pollard D21/754
D397,184 S * 8/1998 Pollard D21/754
D397,185 S * 8/1998 Pollard D21/754
D397,186 S * 8/1998 Pollard D21/754
D401,638 S * 11/1998 Pollard D21/754
D402,727 S * 12/1998 Stutzman D21/754
D402,728 S * 12/1998 Stutzman D21/754
D403,720 S * 1/1999 Colinelli D21/627
D403,725 S * 1/1999 Colinelli D21/627
D403,726 S * 1/1999 Colinelli D21/627
D403,727 S * 1/1999 Colinelli D21/627
5,908,344 A * 6/1999 Kociemba A63B 60/62
150/160

(57) **CLAIM**
The ornamental design for a golf club head cover, as shown and described.

DESCRIPTION

FIG. 1 is a perspective view of a golf club head cover;
FIG. 2 is a perspective view of a golf club head cover shown exploded from an unclaimed golf club head;
FIG. 3 is a perspective view of a golf club head cover shown attached to an unclaimed trophy base;
FIG. 4 is a front view thereof;
FIG. 5 is a rear view thereof;
FIG. 6 is a left side view thereof;
FIG. 7 is a right side view thereof;
FIG. 8 is a top view thereof; and,
FIG. 9 is a bottom view thereof.
The broken line showing is included for the purpose of illustrating and forms no part of the claimed design.

1 Claim, 9 Drawing Sheets

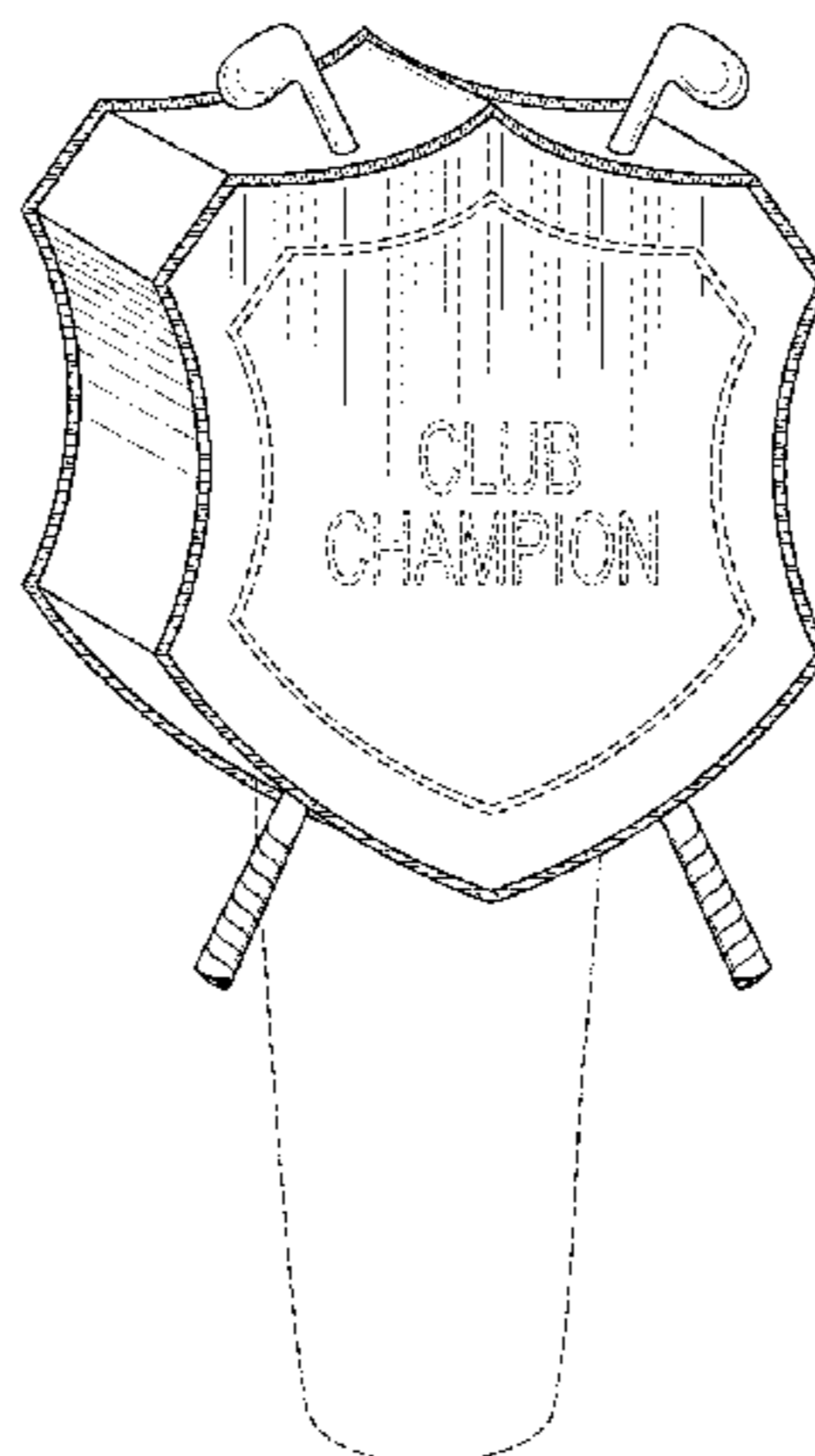

US D767,061 S

Page 2

(56)

References Cited

U.S. PATENT DOCUMENTS

D518,540 S * 4/2006 McCabe D21/754
D524,389 S * 7/2006 McCabe D21/754
D532,856 S * 11/2006 McCabe D21/754
D603,920 S * 11/2009 Heazel D21/754

D661,358 S * 6/2012 Szabo D21/754
D667,066 S * 9/2012 Amella D21/754
D670,777 S * 11/2012 Roberts D21/754
2011/0217563 A1* 9/2011 Stoelting B44C 5/04
428/542.4

* cited by examiner

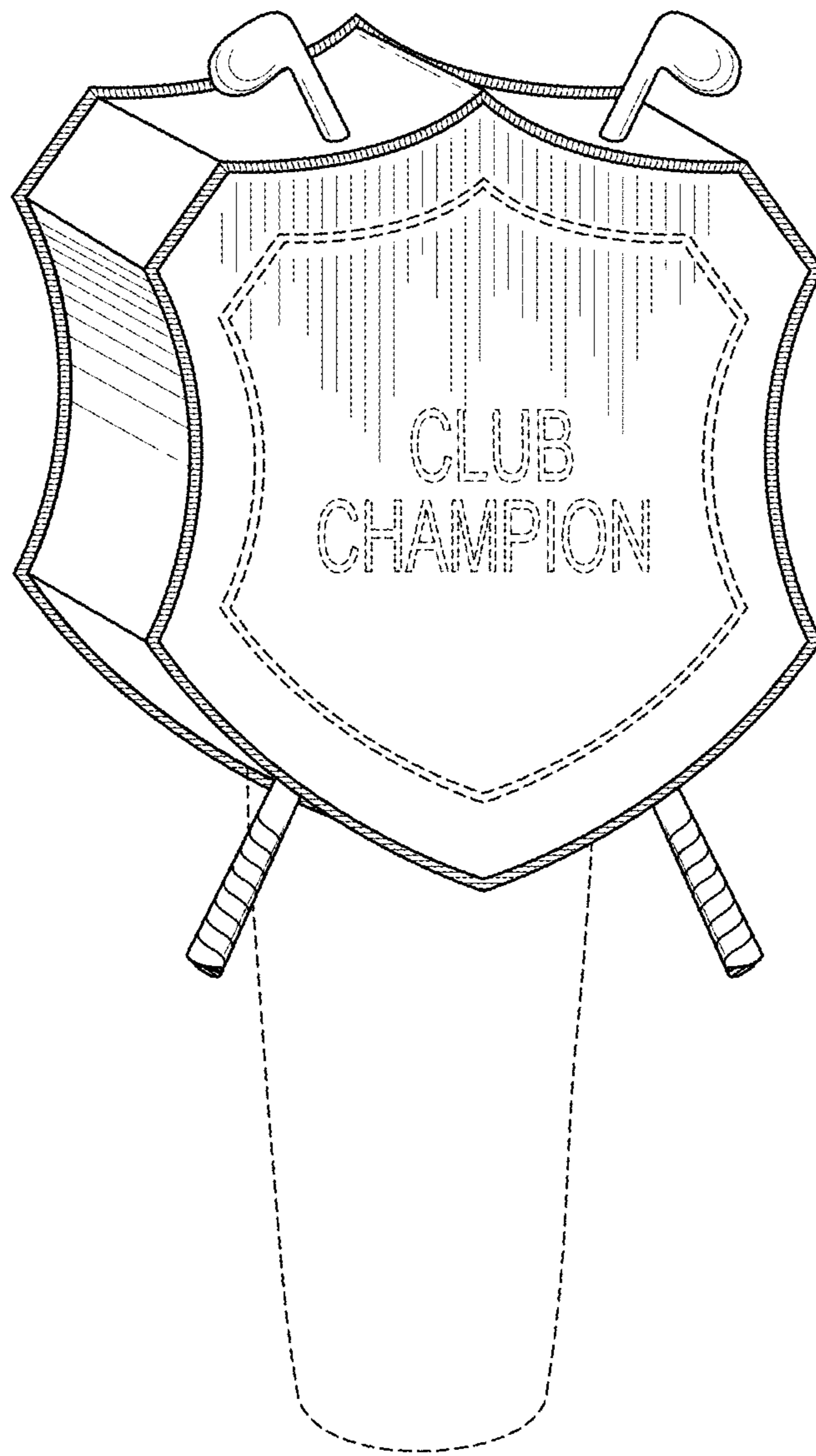

FIG. 1

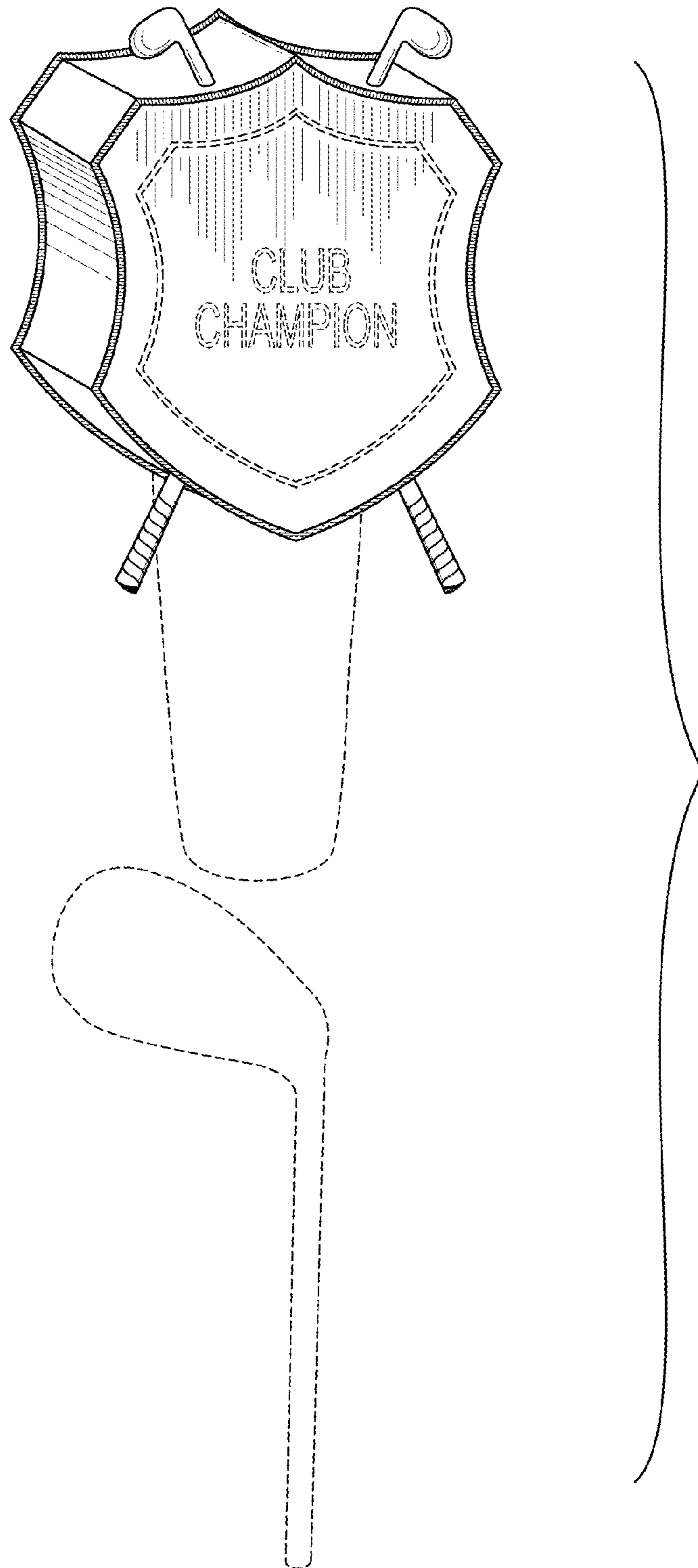

FIG. 2

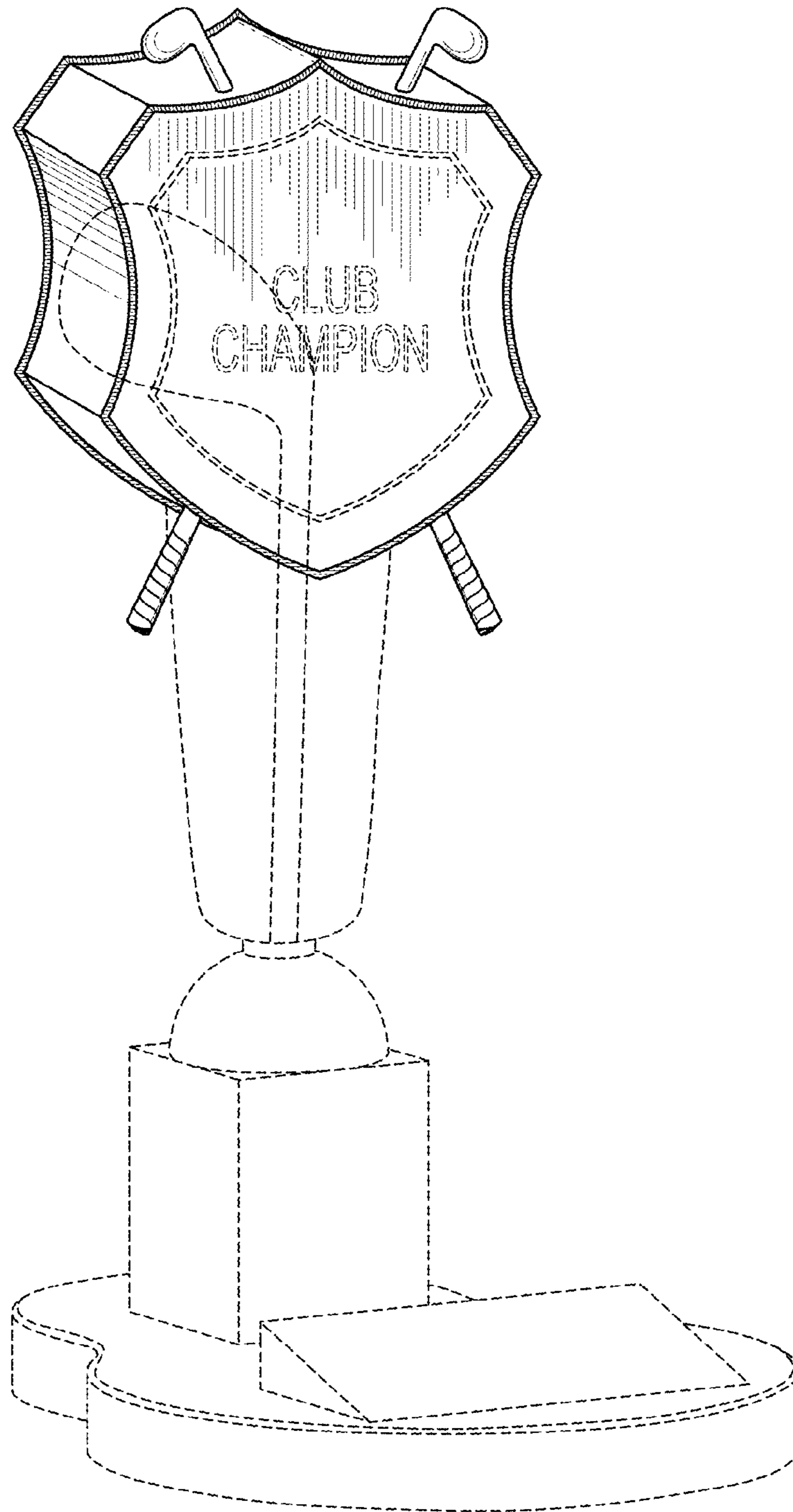

FIG. 3

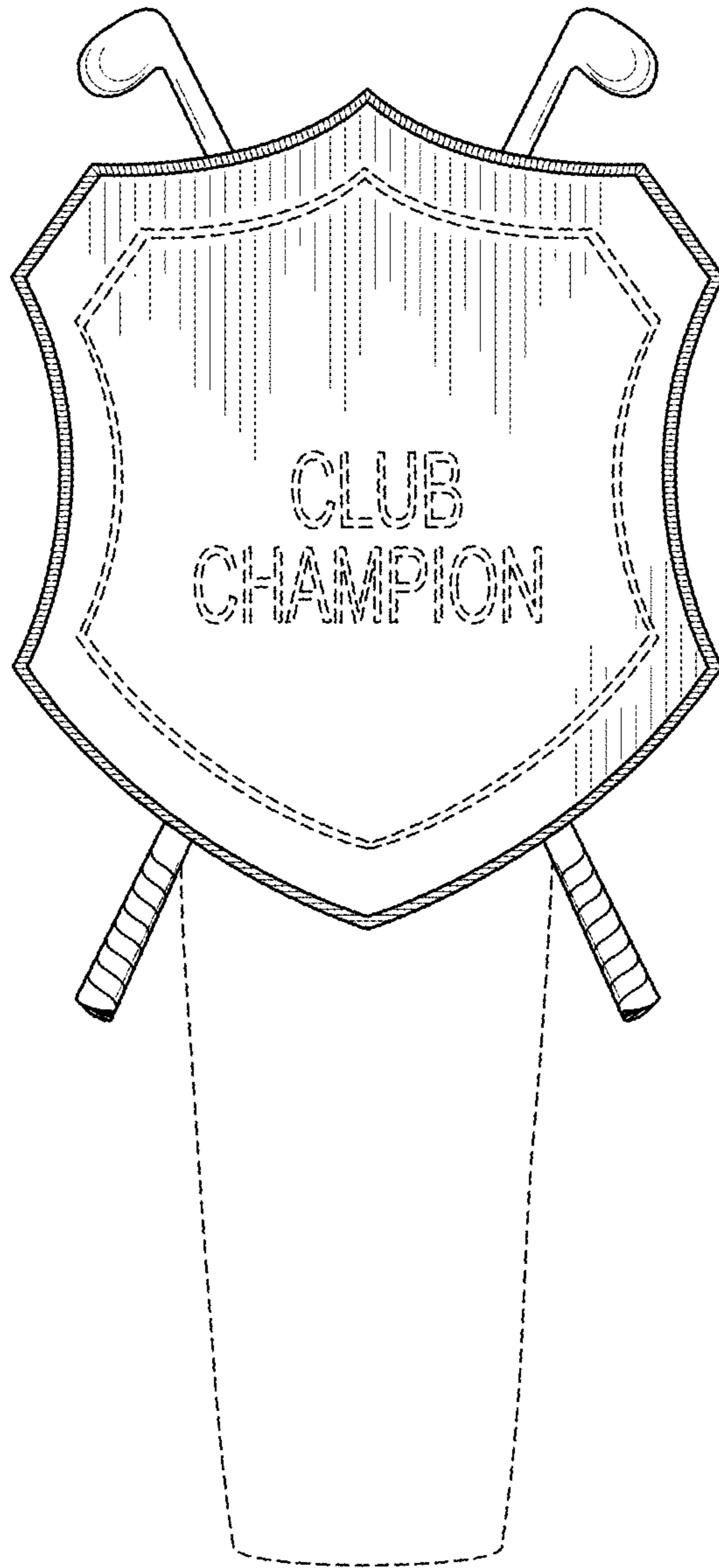

FIG. 4

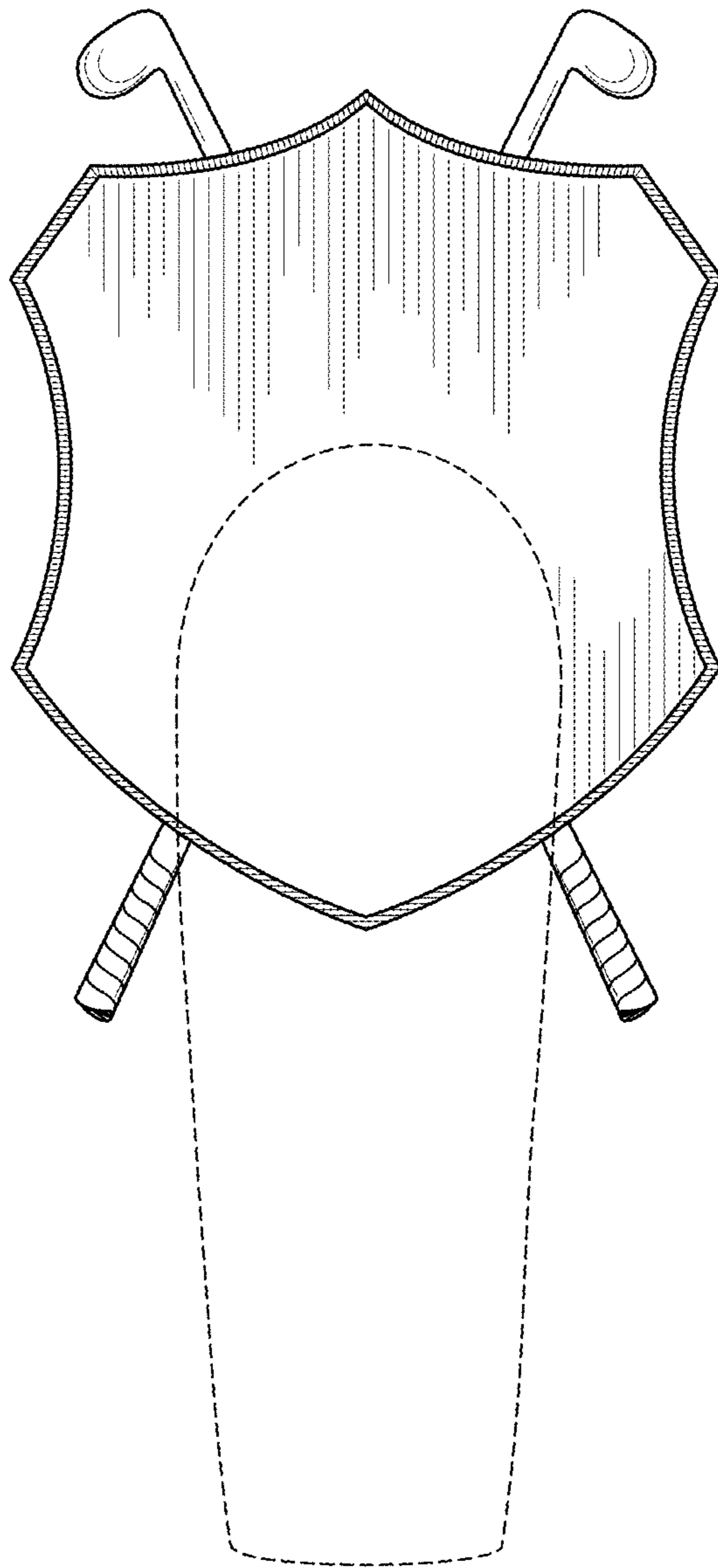

FIG. 5

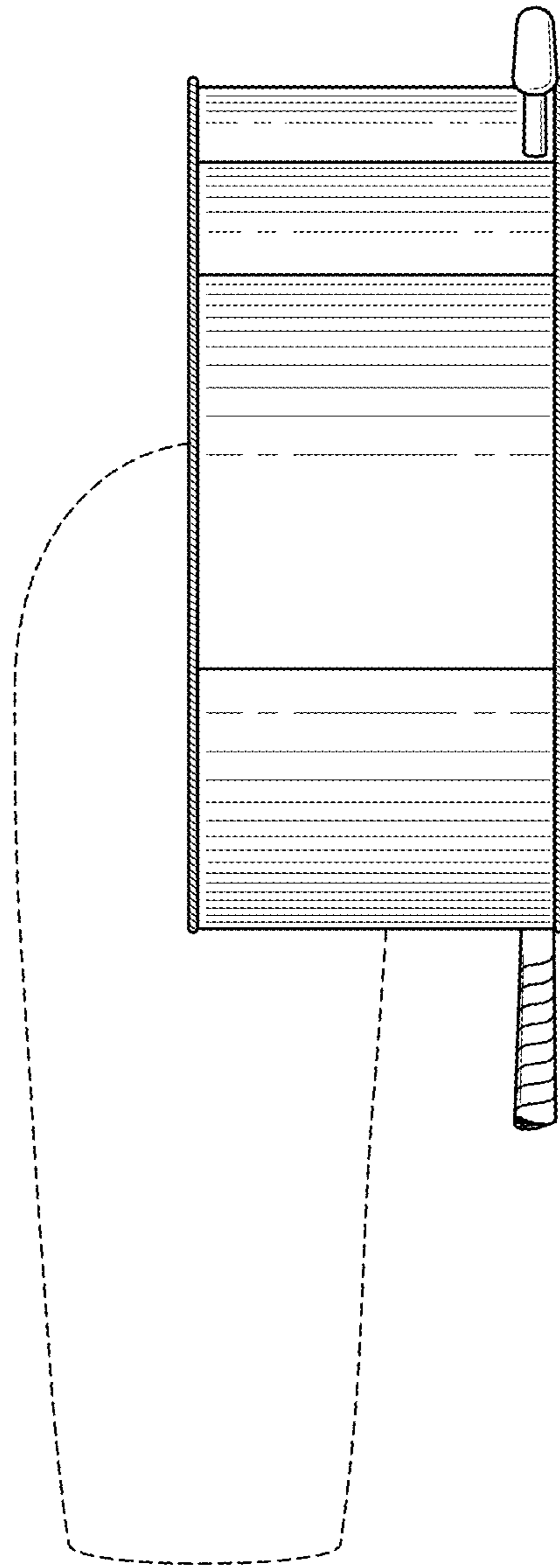

FIG. 6

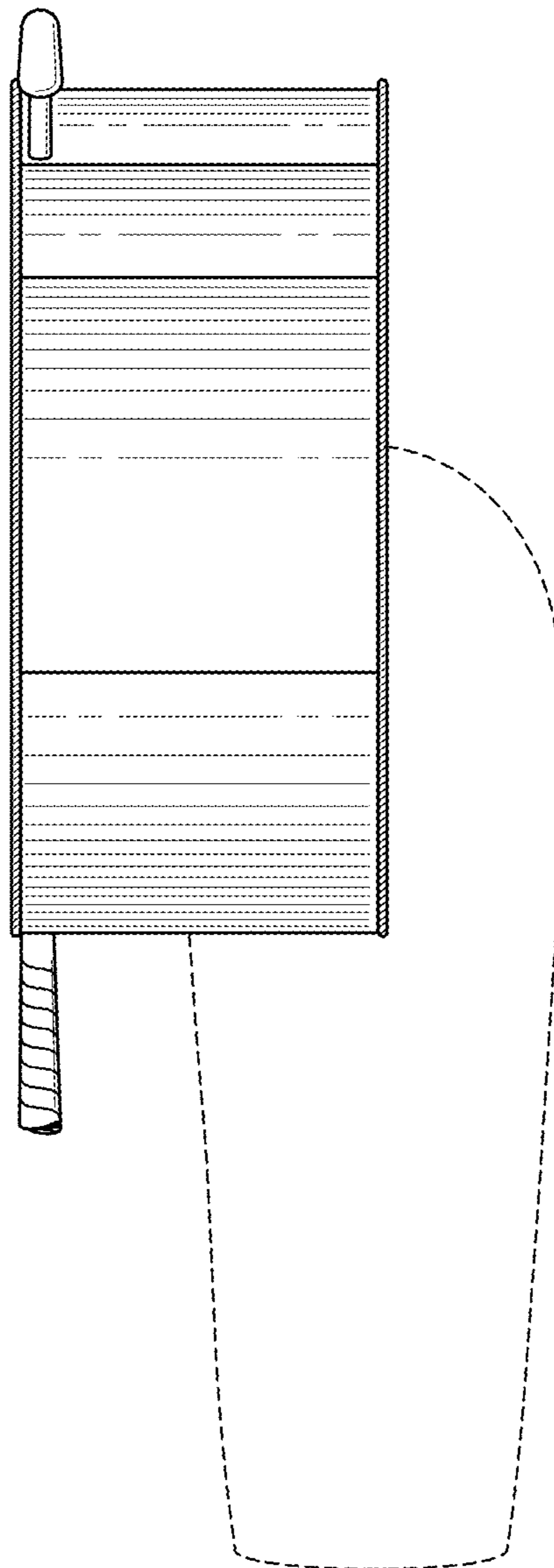

FIG. 7

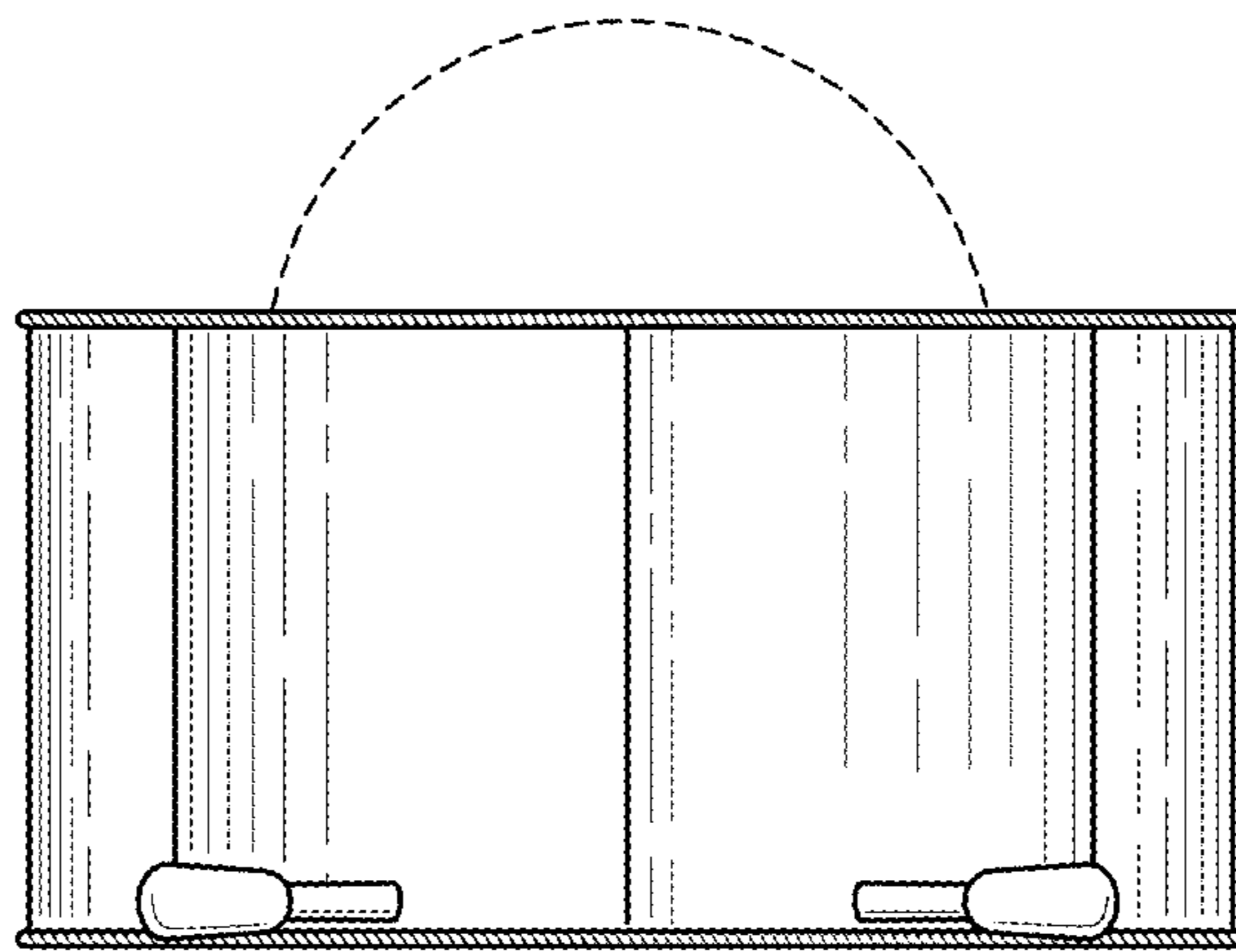

FIG. 8

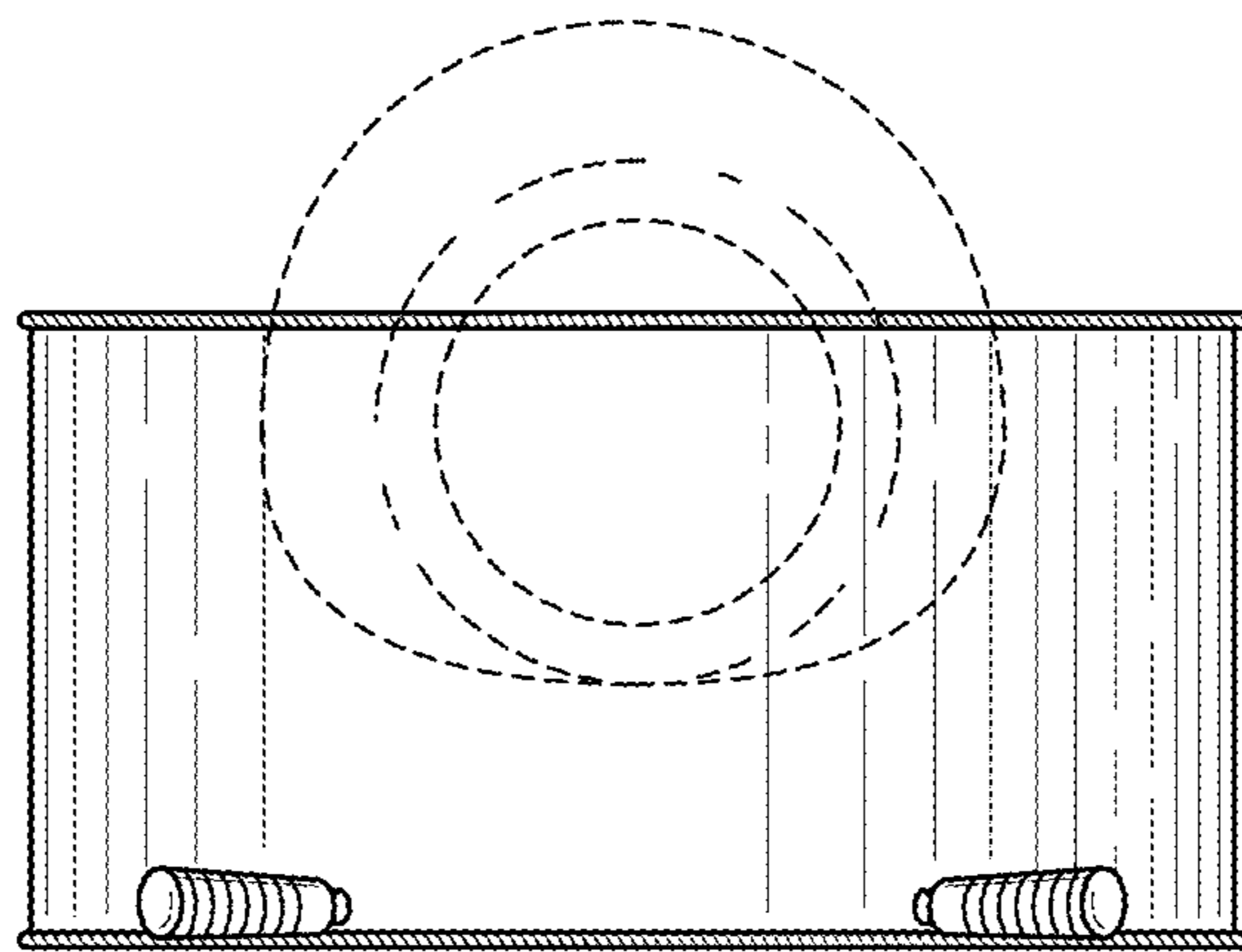

FIG. 9