



US00D767056S

(12) **United States Design Patent**
Zaccaro

(10) **Patent No.:** **US D767,056 S**

(45) **Date of Patent:** **** Sep. 20, 2016**

(54) **RACKET**

(71) Applicant: **Sergio Plaster Zaccaro**, Rio de Janeiro (BR)

(72) Inventor: **Sergio Plaster Zaccaro**, Rio de Janeiro (BR)

(**) Term: **14 Years**

(21) Appl. No.: **29/520,060**

(22) Filed: **Mar. 10, 2015**

(30) **Foreign Application Priority Data**

Sep. 10, 2014 (BR) 30 2014 004500 8

(51) **LOC (10) Cl.** **21-02**

(52) **U.S. Cl.**
USPC **D21/731**

(58) **Field of Classification Search**
USPC D21/729-732
CPC A63B 60/40; A63B 59/40; A63B 59/42;
A63B 67/04

See application file for complete search history.

(56) **References Cited**

U.S. PATENT DOCUMENTS

- 1,477,460 A * 12/1923 Smith A63B 60/40
473/518
- 1,523,899 A * 1/1925 Rittenhouse A63B 60/40
473/518
- D93,151 S * 8/1934 Young D21/731
- 3,239,224 A * 3/1966 Finn A63B 49/08
473/526
- 3,674,268 A * 7/1972 Shellman, Sr. A63B 59/40
473/526

(Continued)

FOREIGN PATENT DOCUMENTS

- BR PI 0203089-6 A 6/2004
- KR 10-2012-0101851 A 9/2012

Primary Examiner — Mitchell Siegel

(74) *Attorney, Agent, or Firm* — Christensen O'Connor Johnson Kindness PLLC

(57) **CLAIM**

The ornamental design for a racket, as shown and described.

DESCRIPTION

FIG. 1 is a perspective view of the racket taken from the back side thereof;
 FIG. 2 is a rear elevational view of FIG. 1;
 FIG. 3 is a front elevational view of FIG. 1;
 FIG. 4 is a side view of FIG. 1;
 FIG. 5 is a side view of FIG. 1, taken from the opposite side of FIG. 4;
 FIG. 6 is a top view of FIG. 1; and
 FIG. 7 is a bottom view of FIG. 1.
 FIG. 8 is a rear perspective view of another embodiment of the racket of the present design;
 FIG. 9 is a rear view of FIG. 8;
 FIG. 10 is a front view of FIG. 8;
 FIG. 11 is a side view of FIG. 8;
 FIG. 12 is a side view of FIG. 8, taken from the opposite side of FIG. 11;
 FIG. 13 is a top view of FIG. 8; and
 FIG. 14 is a bottom view of FIG. 8.
 FIG. 15 is a rear perspective view of another embodiment of the racket of the present design;
 FIG. 16 is a rear view of FIG. 15;
 FIG. 17 is a front view of FIG. 15;
 FIG. 18 is a side view of FIG. 15;
 FIG. 19 is a side view of FIG. 15, taken from the opposite side of FIG. 18;
 FIG. 20 is a top view of FIG. 15; and
 FIG. 21 is a bottom view of FIG. 15.
 FIG. 22 is a rear perspective view of another embodiment of the racket of the present design;
 FIG. 23 is a rear view of FIG. 22;
 FIG. 24 is a front view of FIG. 22;
 FIG. 25 is a side view of FIG. 22;
 FIG. 26 is a side view of FIG. 22, taken from the opposite side of FIG. 25;
 FIG. 27 is a top view of FIG. 22; and
 FIG. 28 is a bottom view of FIG. 22.

1 Claim, 20 Drawing Sheets

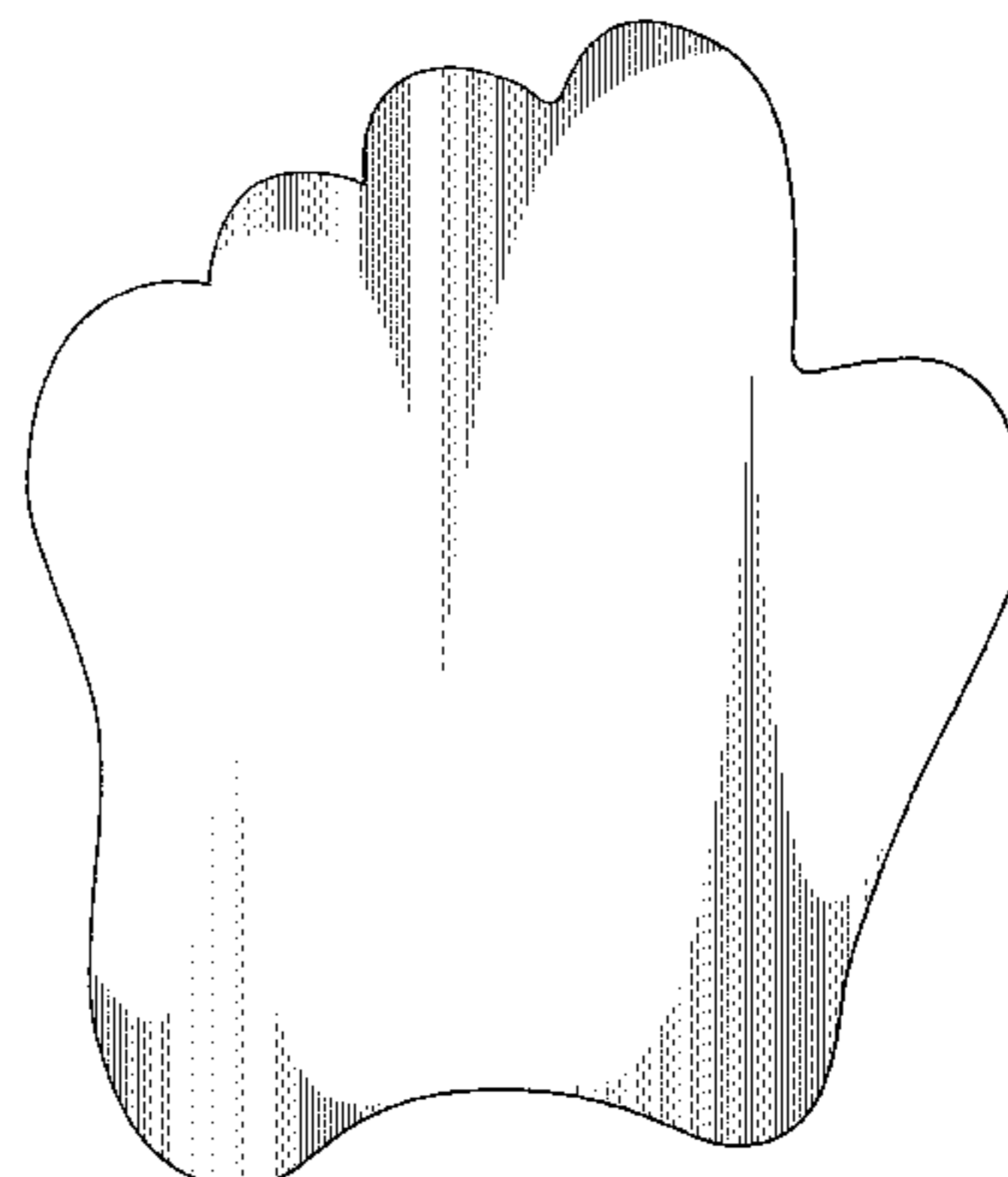
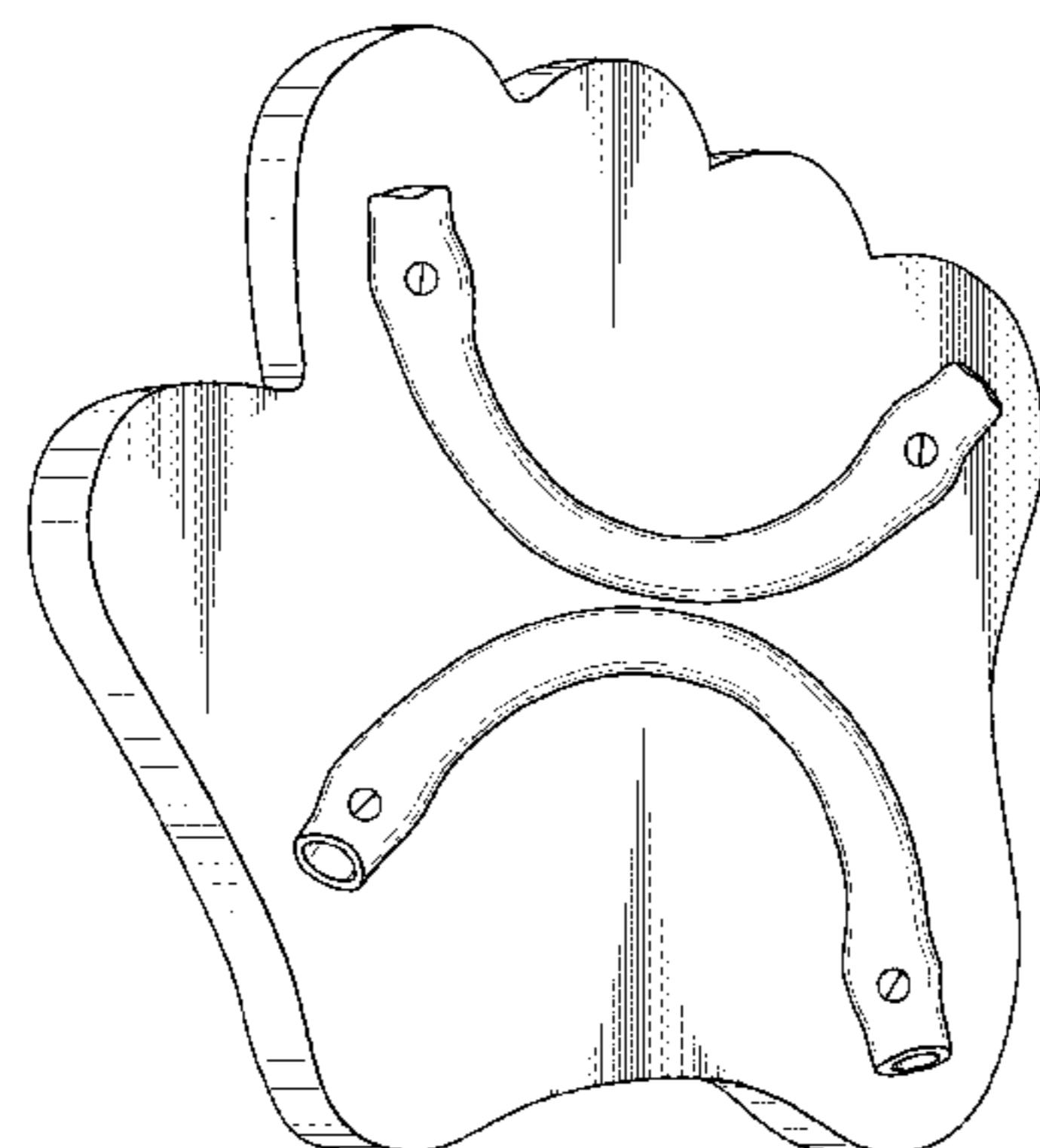

(56)

References Cited

U.S. PATENT DOCUMENTS

4,307,882	A *	12/1981	Hay	A63B 67/04	D315,586	S *	3/1991	Edelstein	D21/732
					273/317	5,312,101	A *	5/1994	McDaniel	A63B 59/40
4,387,895	A *	6/1983	Steel	A63B 60/40						473/526
					473/518	D360,920	S *	8/1995	Lessard	D21/731
4,516,774	A	5/1985	Nankivell			5,839,979	A *	11/1998	De Genty	A63B 60/40
4,802,669	A	2/1989	Birmingham								473/463
4,874,168	A	10/1989	Wright			D501,521	S *	2/2005	Reynolds	D21/731
						D620,061	S *	7/2010	Morrison	D21/731
						D678,440	S *	3/2013	Williams	D21/731

* cited by examiner

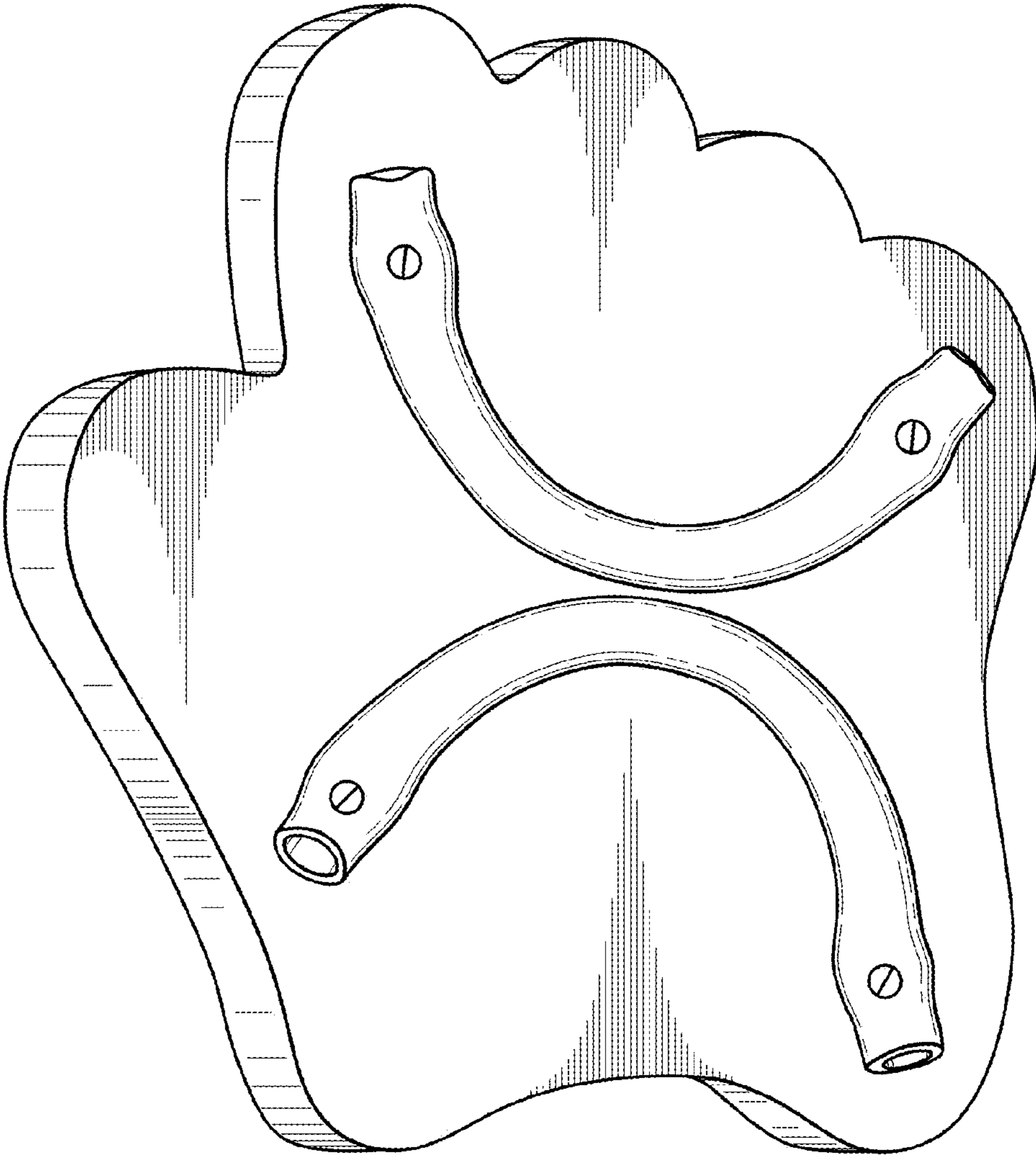

Fig. 1.

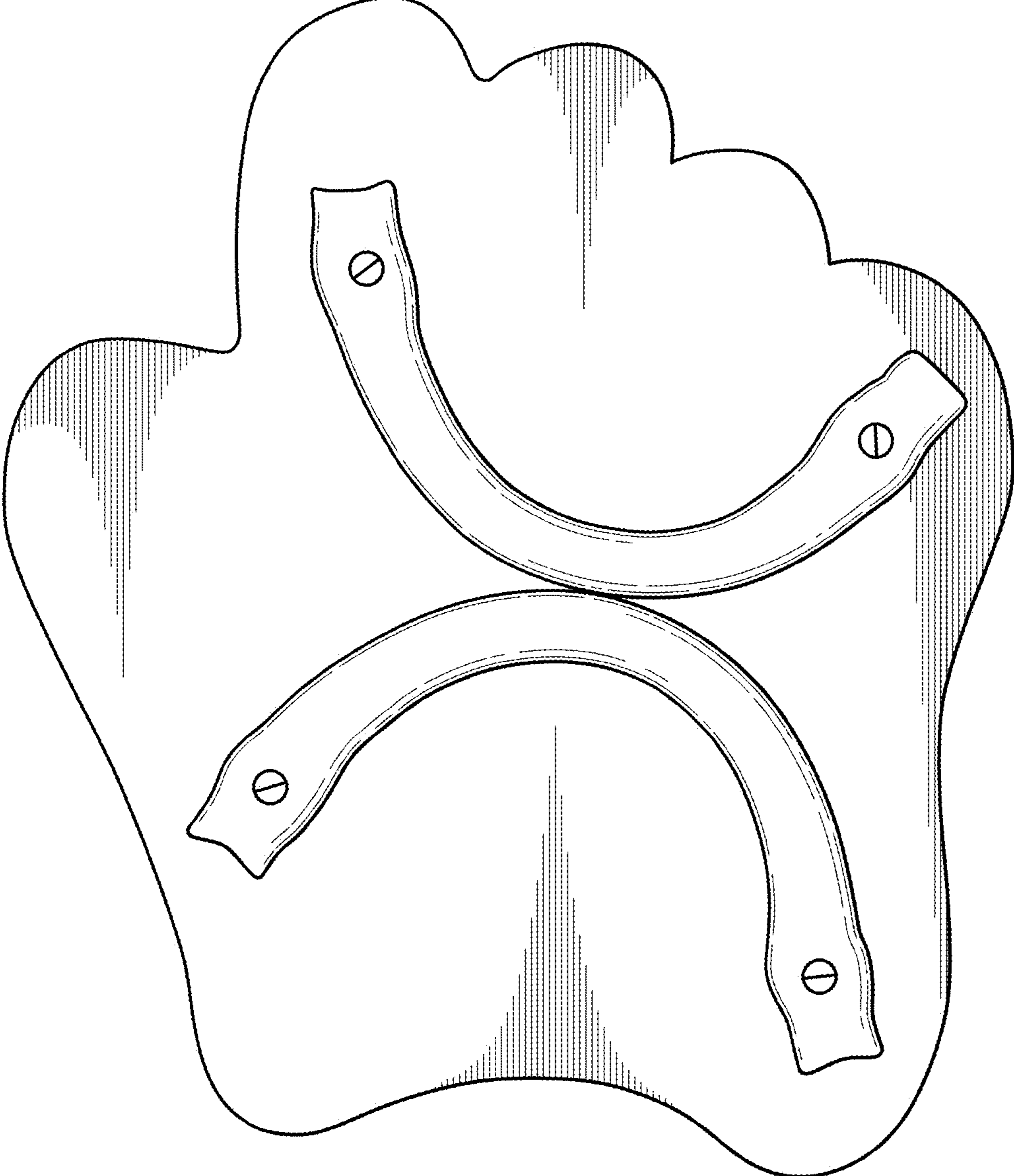

Fig. 2.

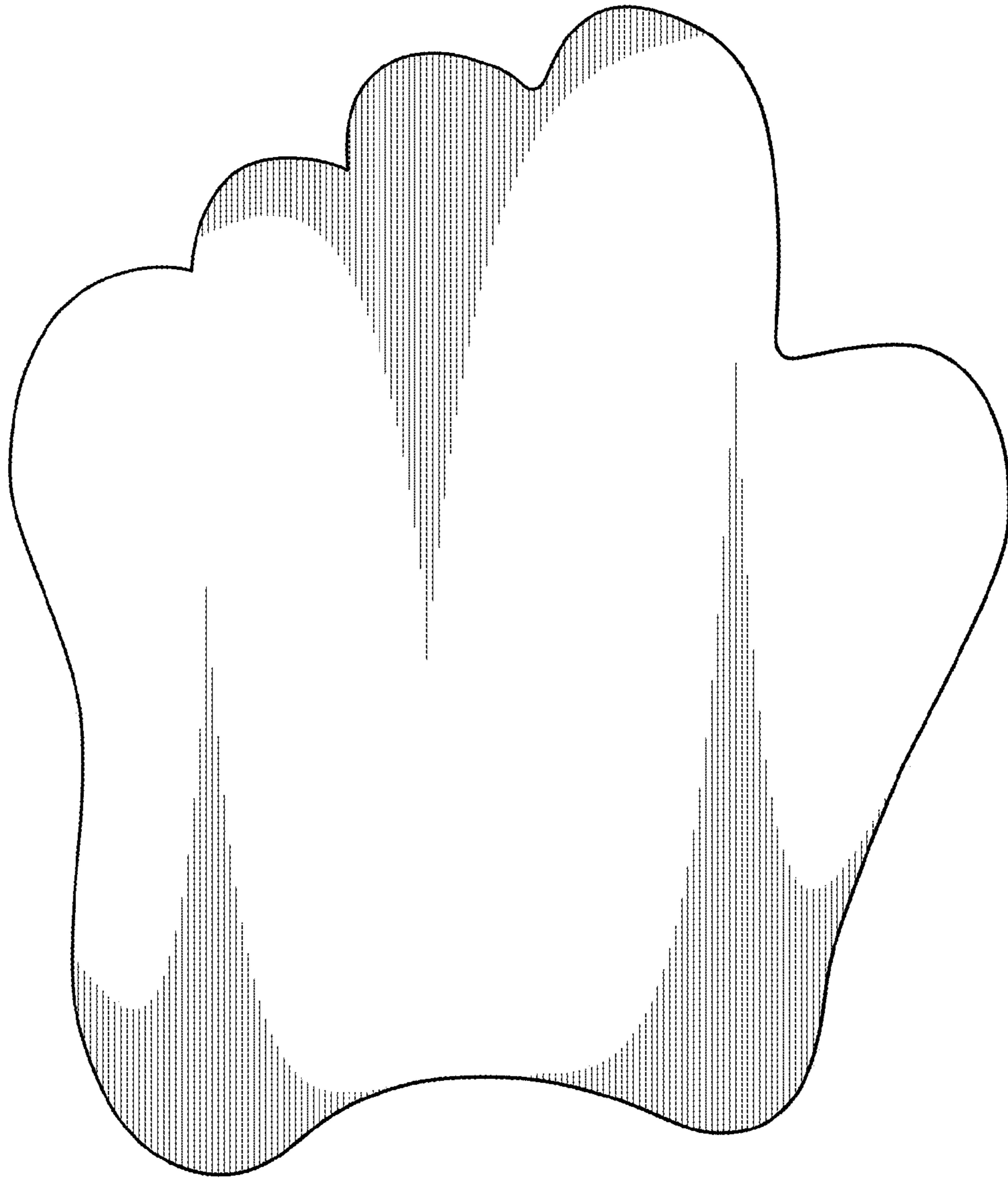

Fig. 3.

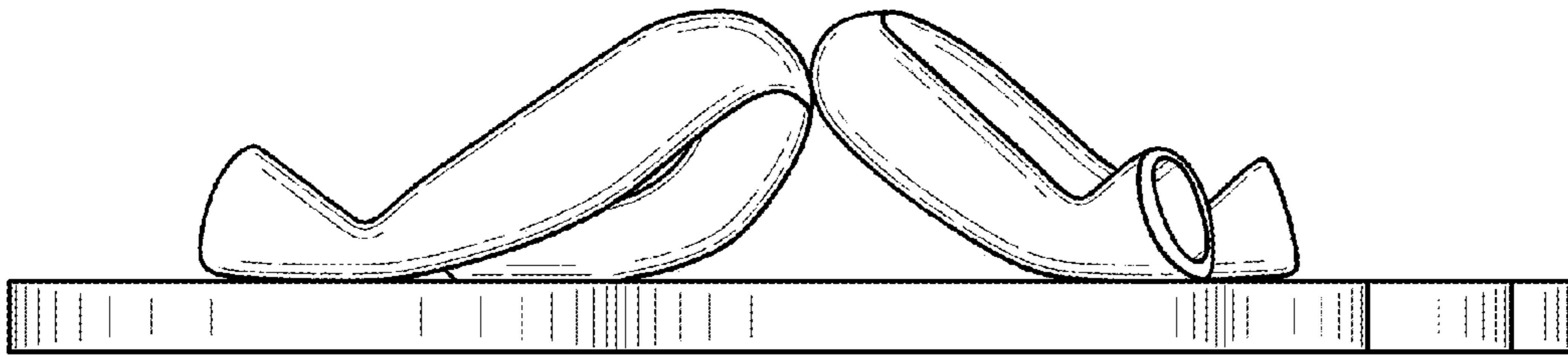

Fig. 4.

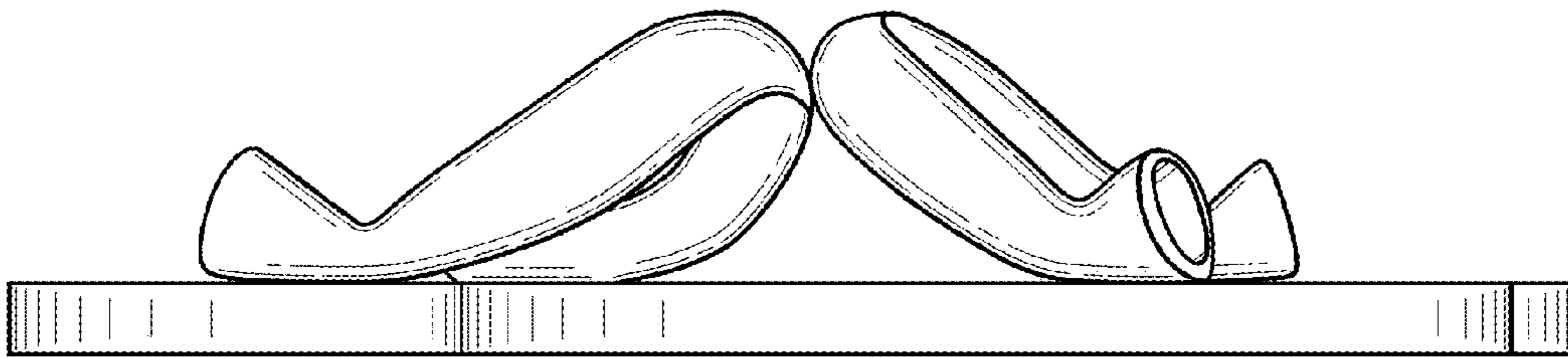

Fig. 5.

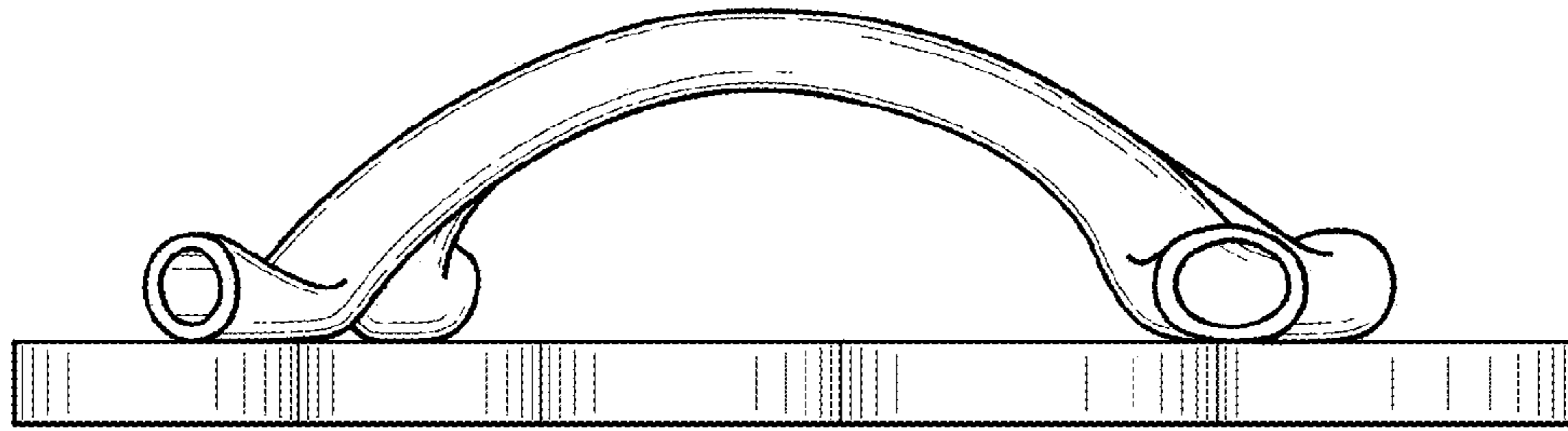

Fig. 6.

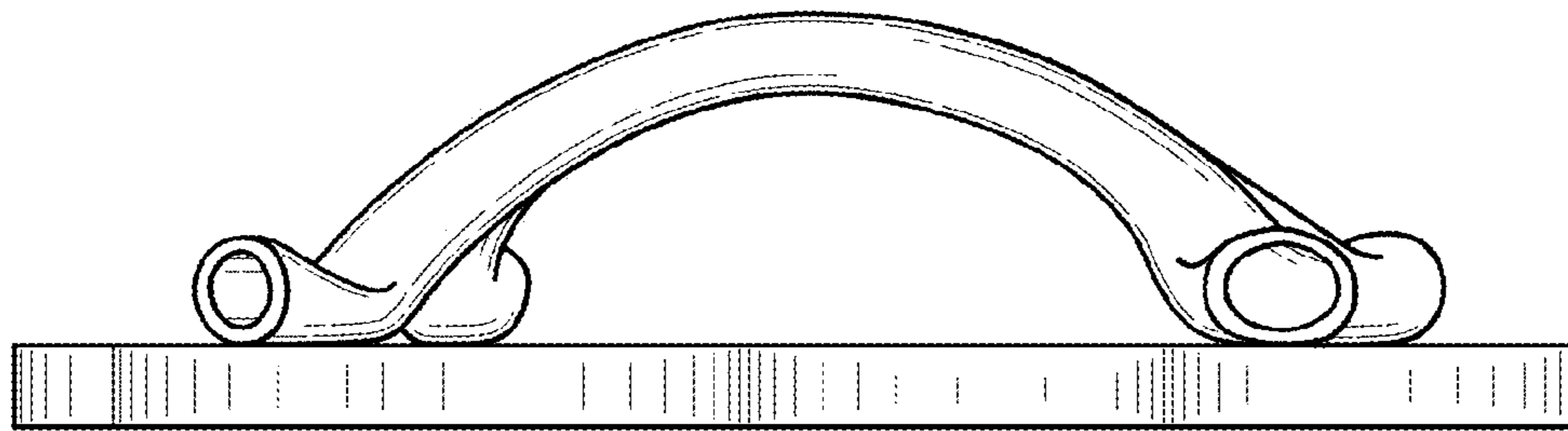

Fig. 7.

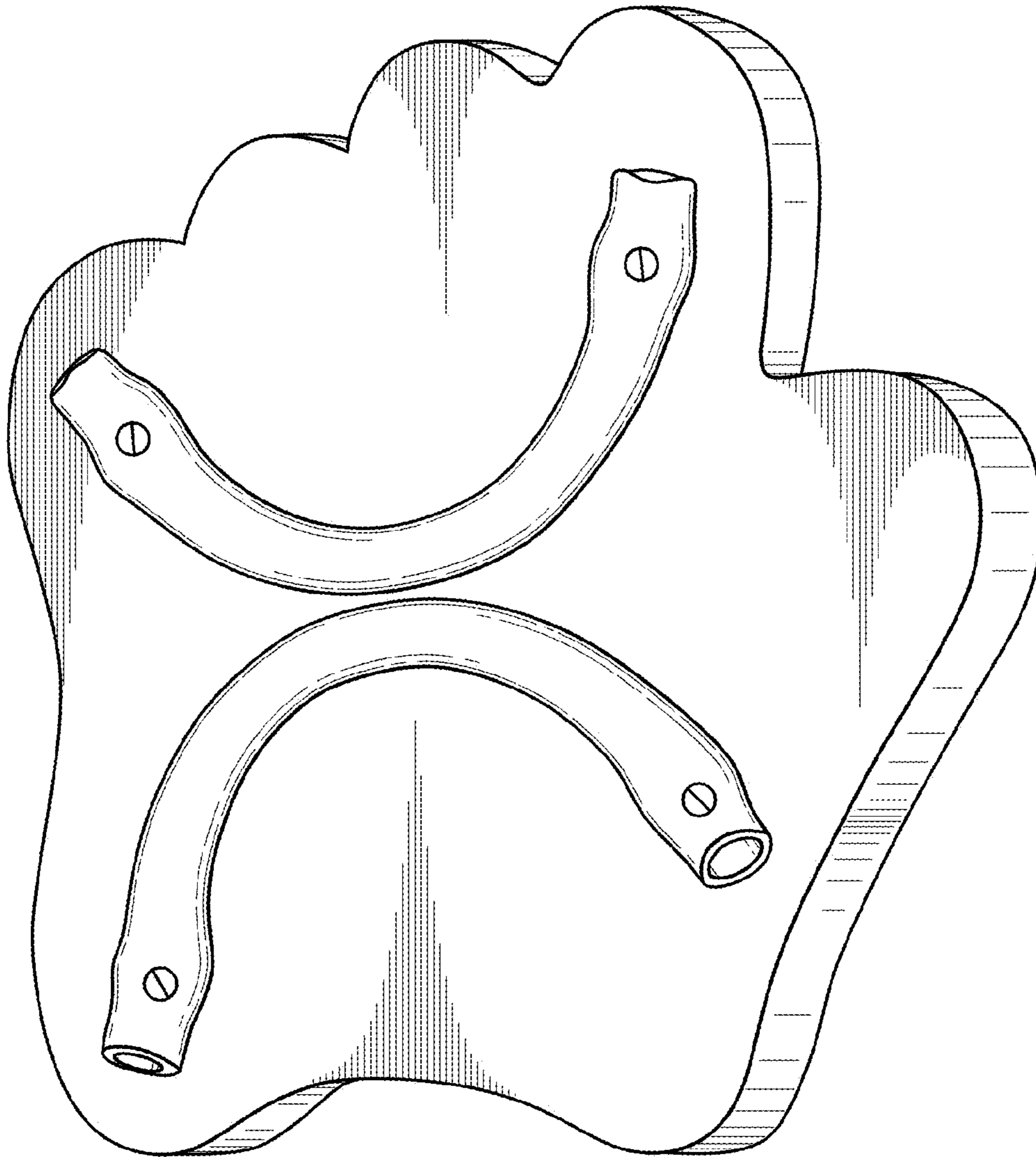

Fig. 8.

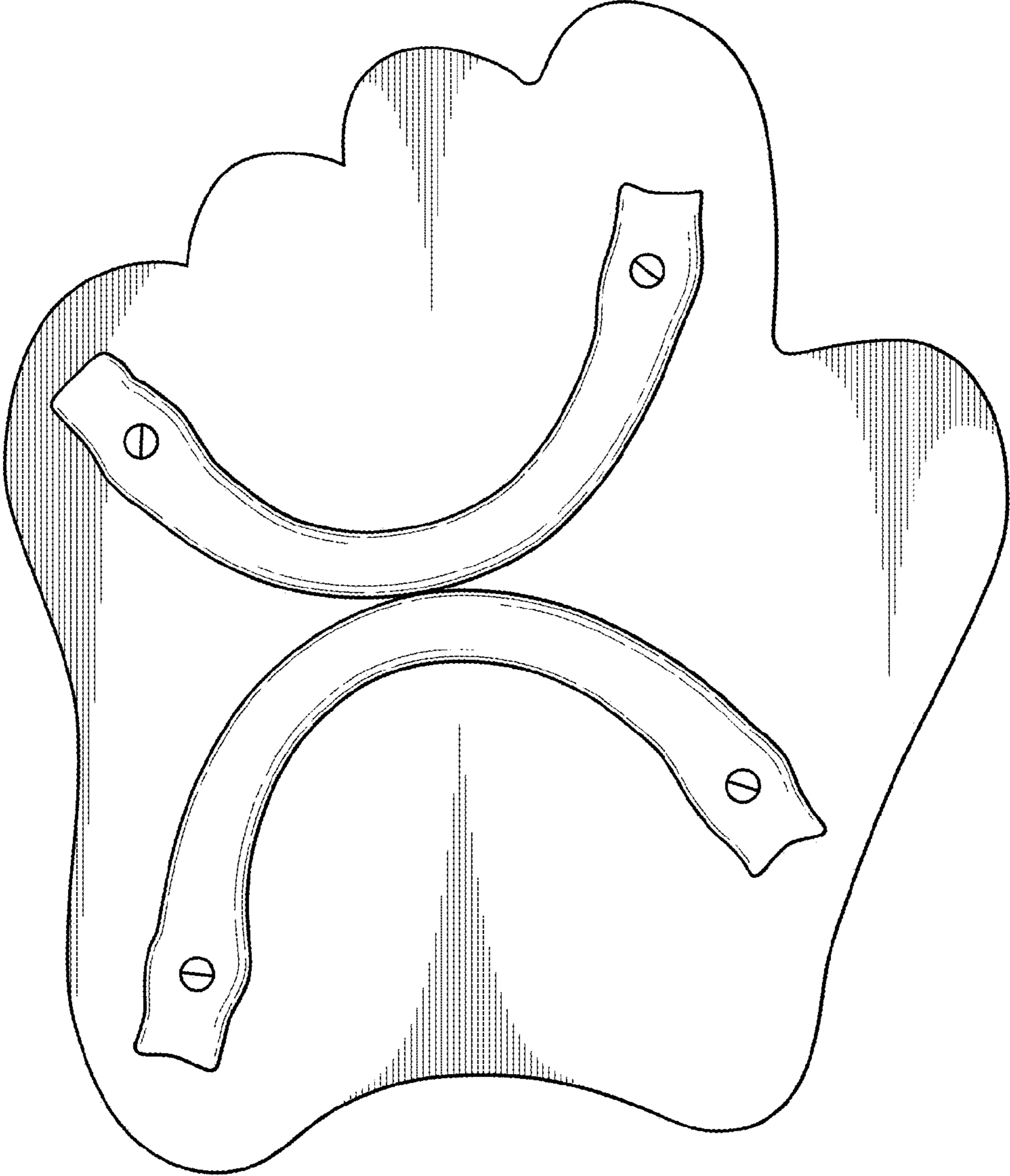

Fig. 9.

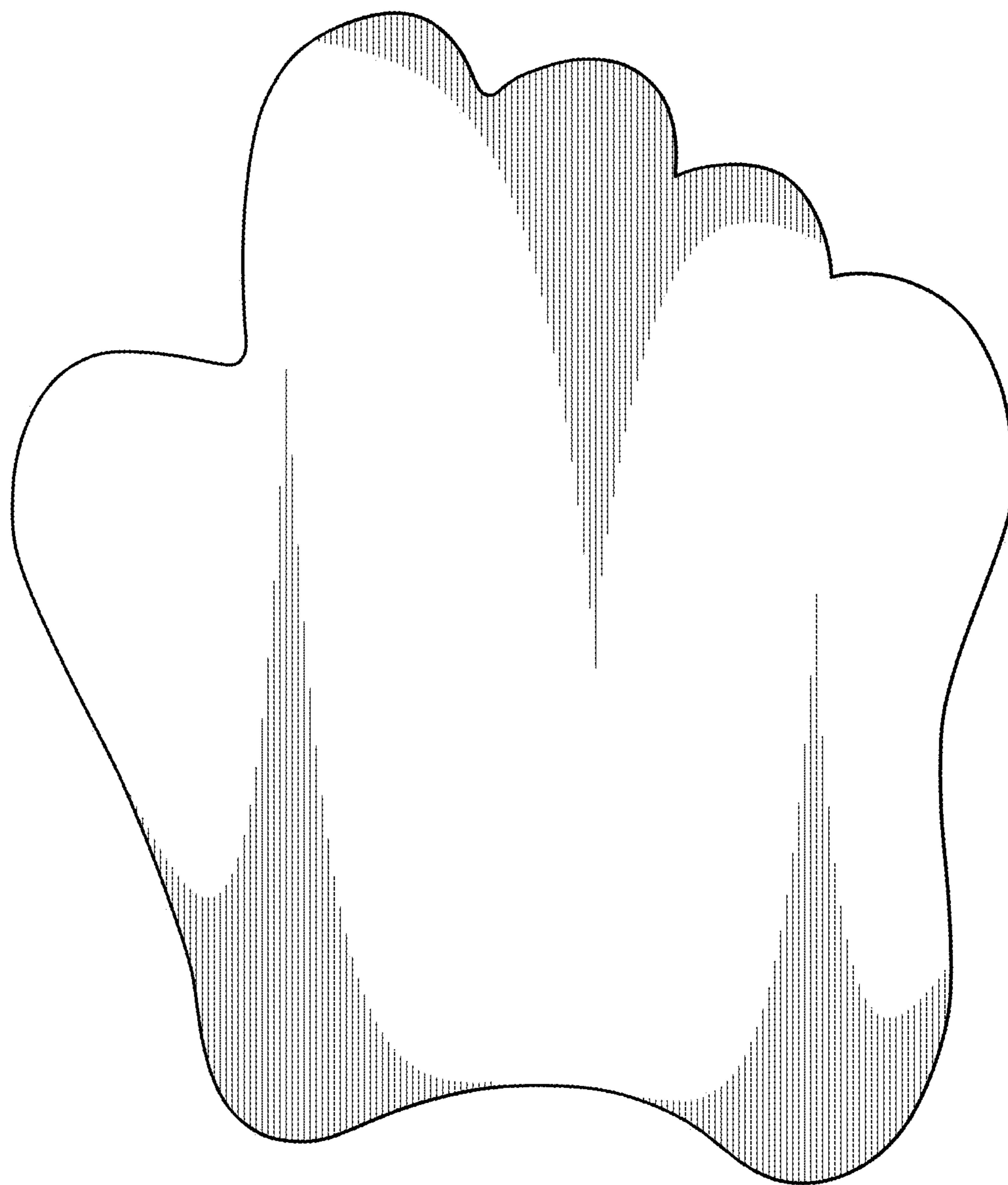

Fig. 10.

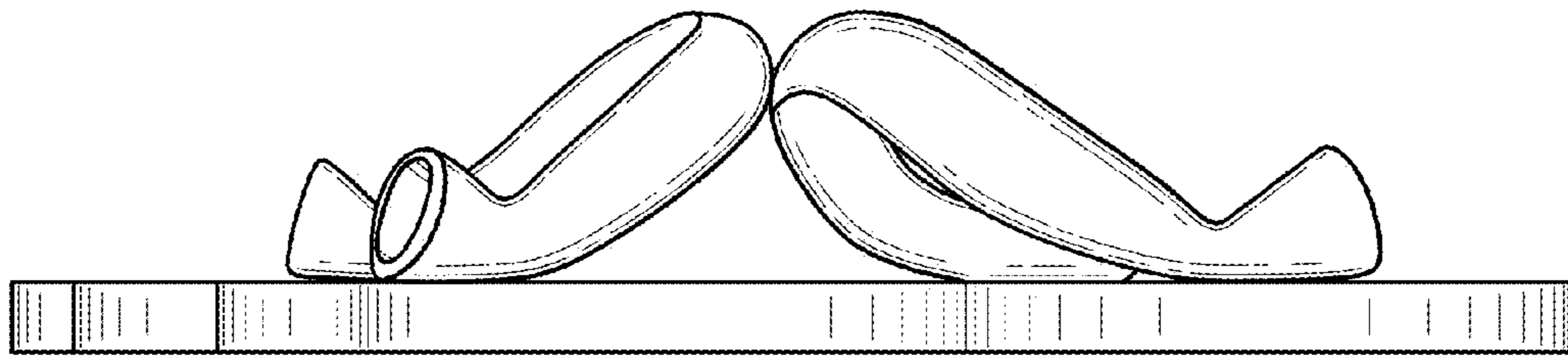

Fig. 11.

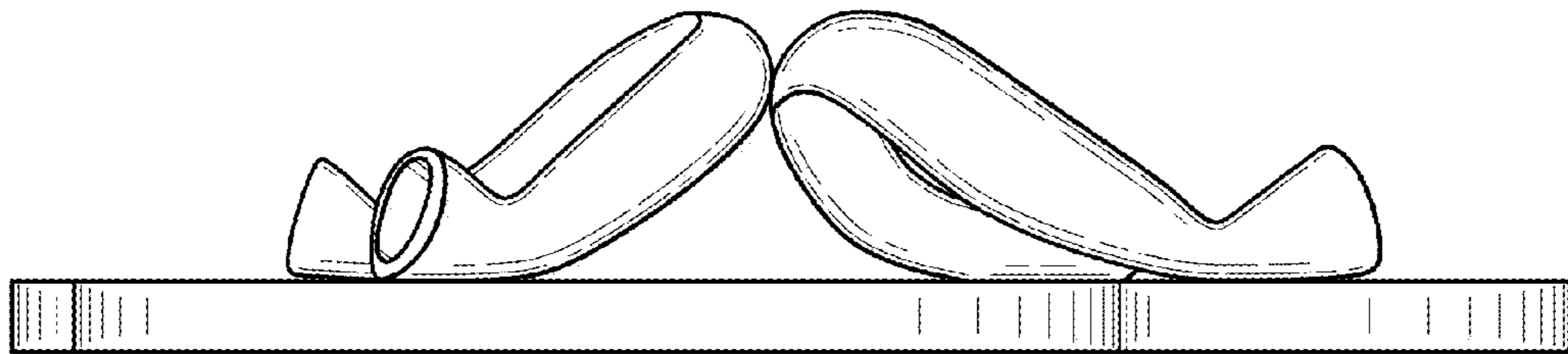

Fig. 12.

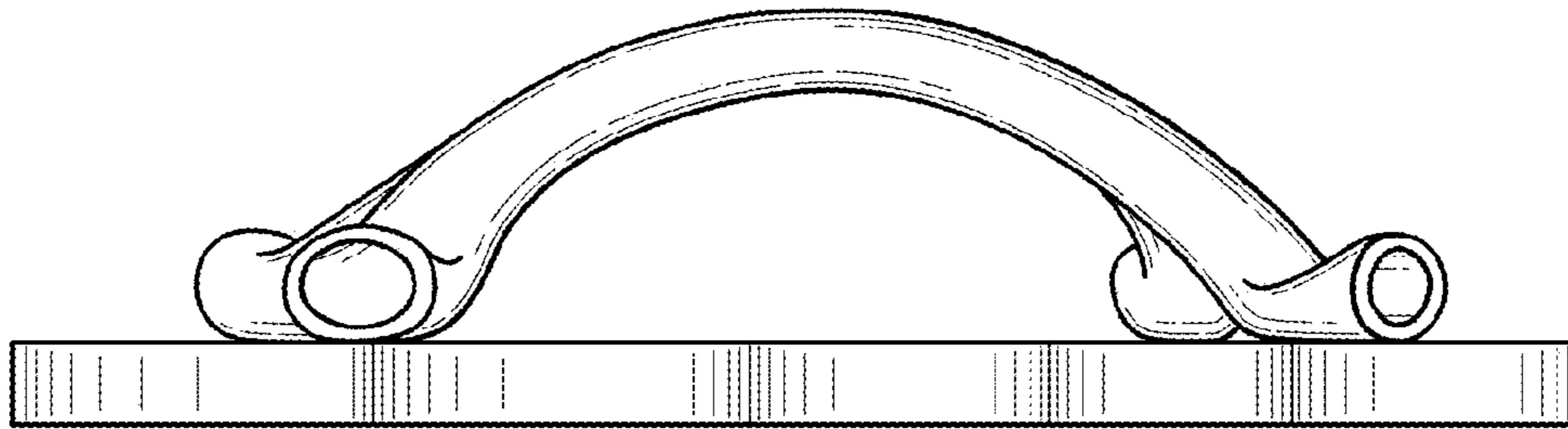

Fig. 13.

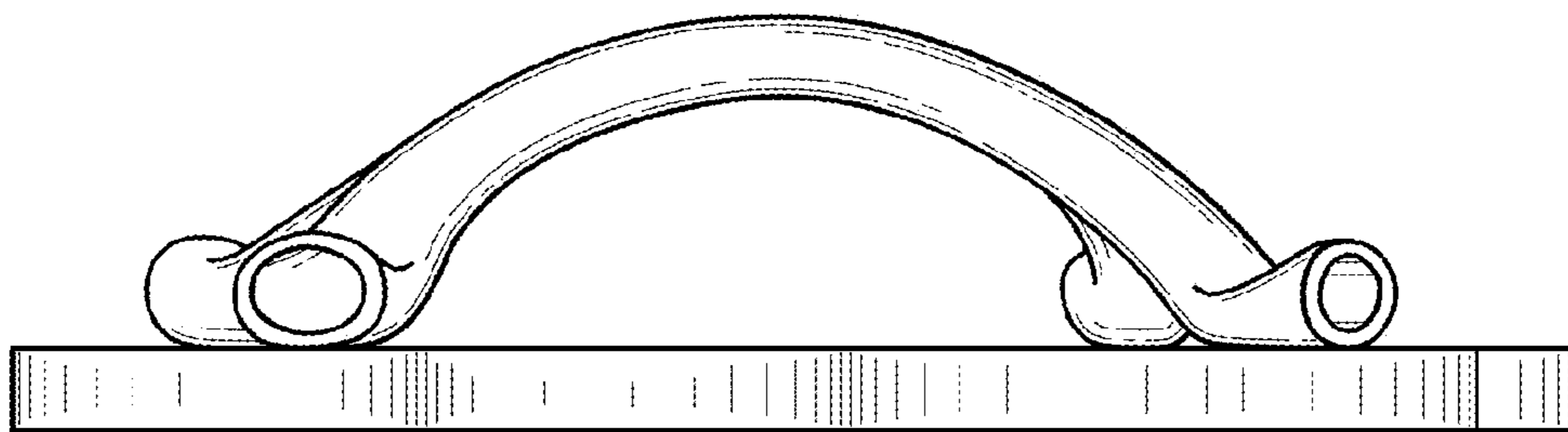

Fig. 14.

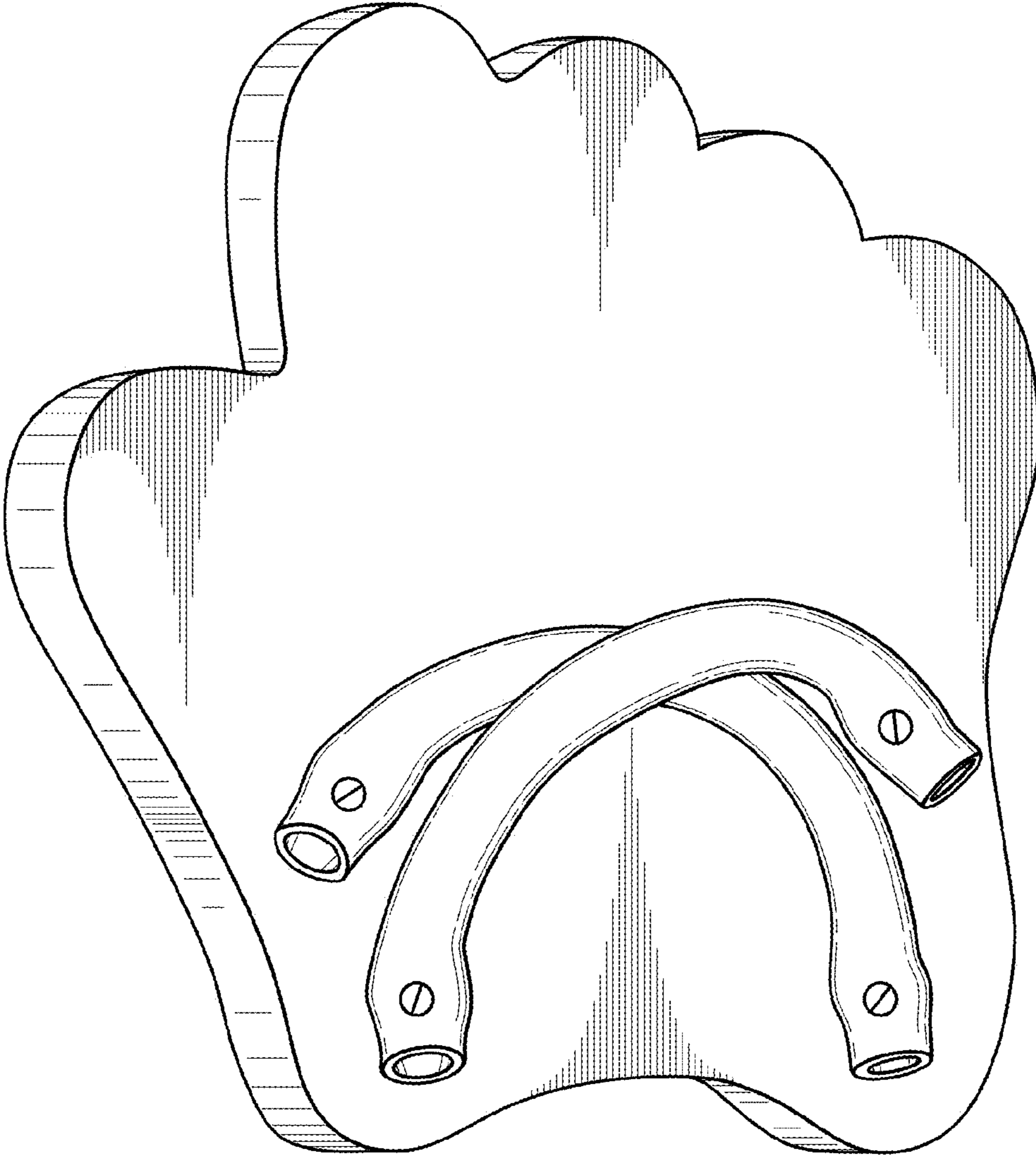

Fig. 15.

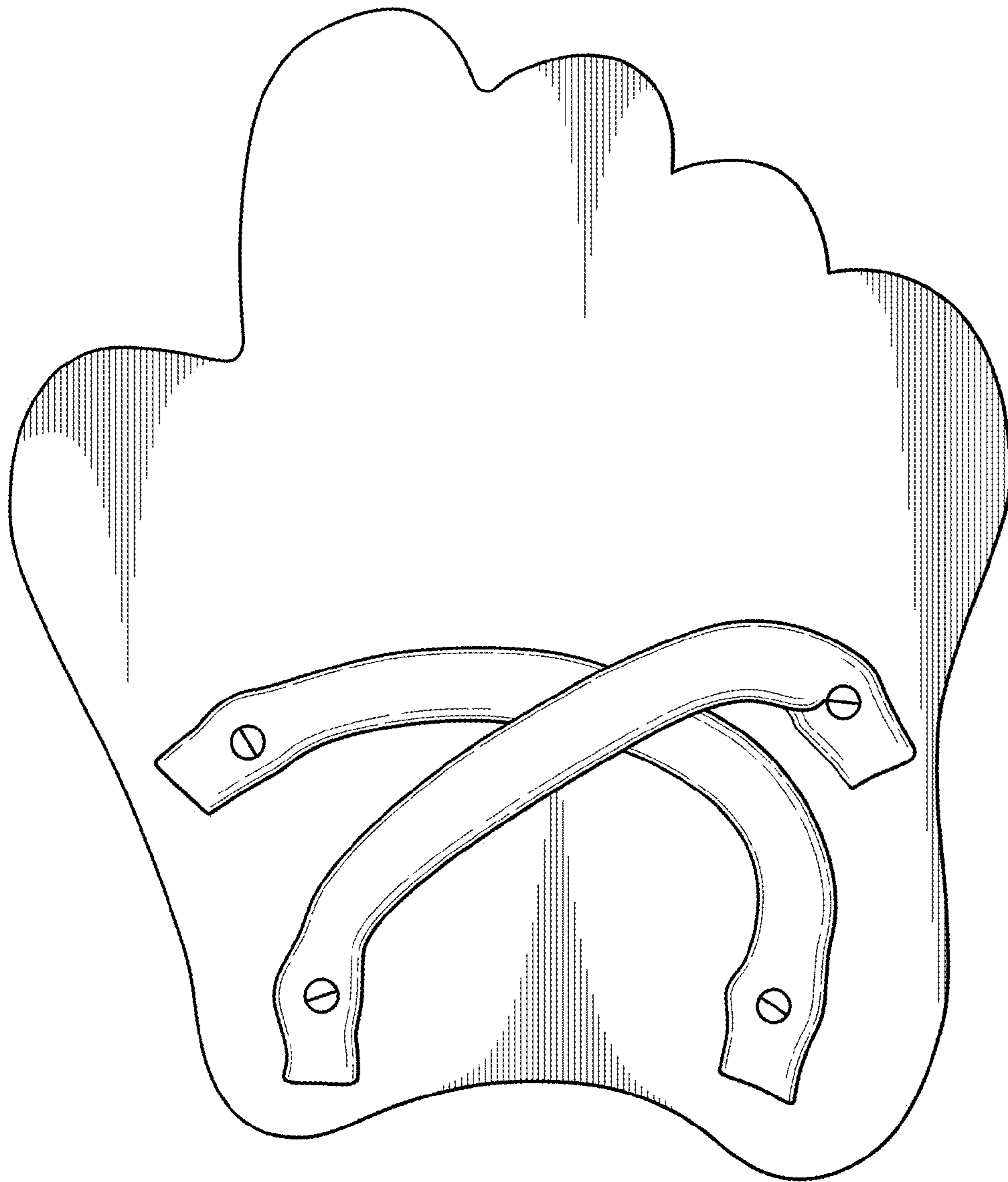

Fig. 16.

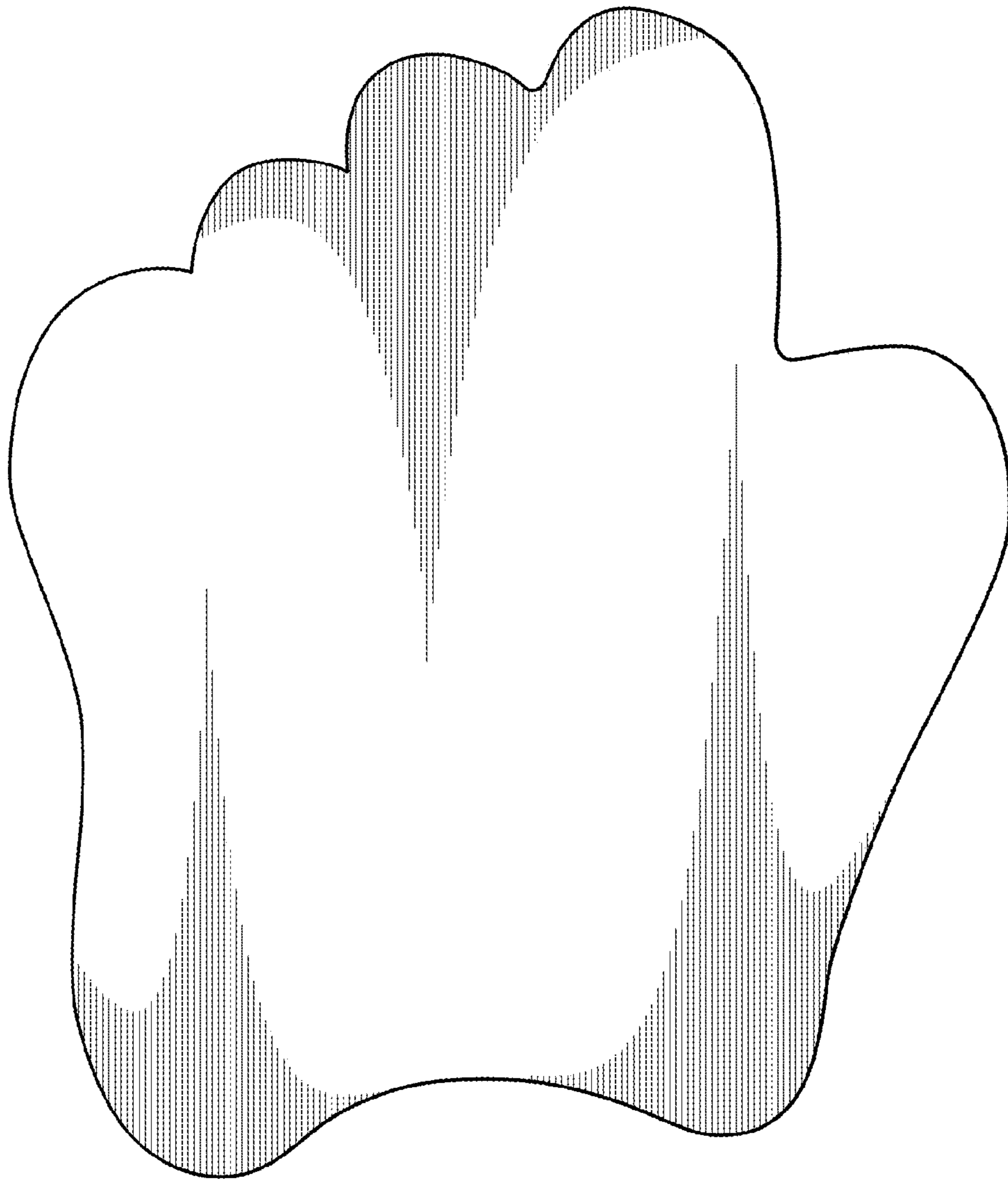

Fig. 17.

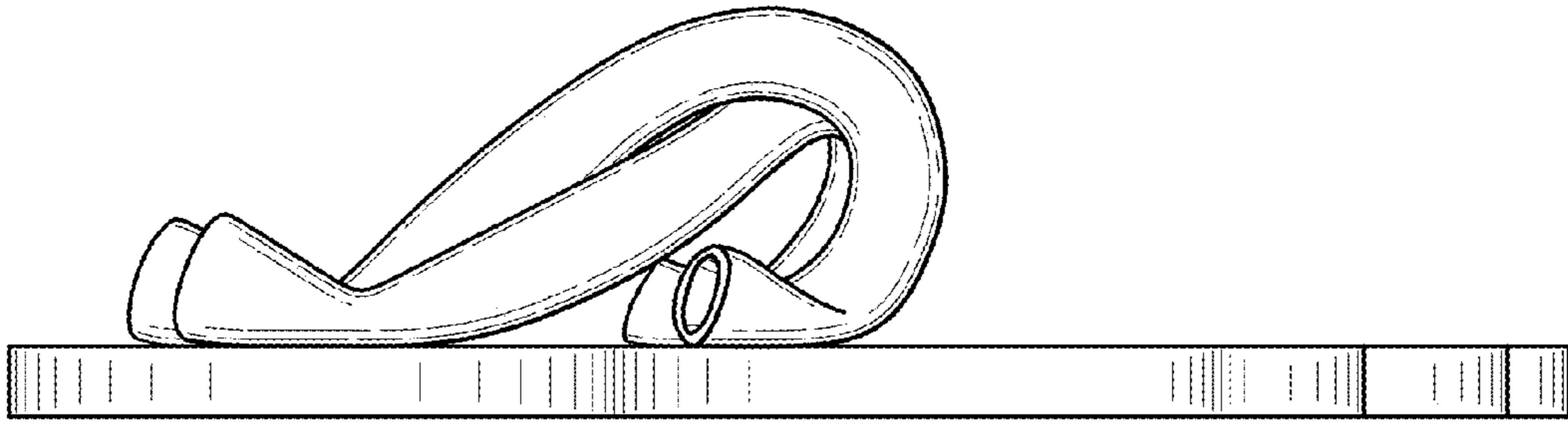

Fig. 18.

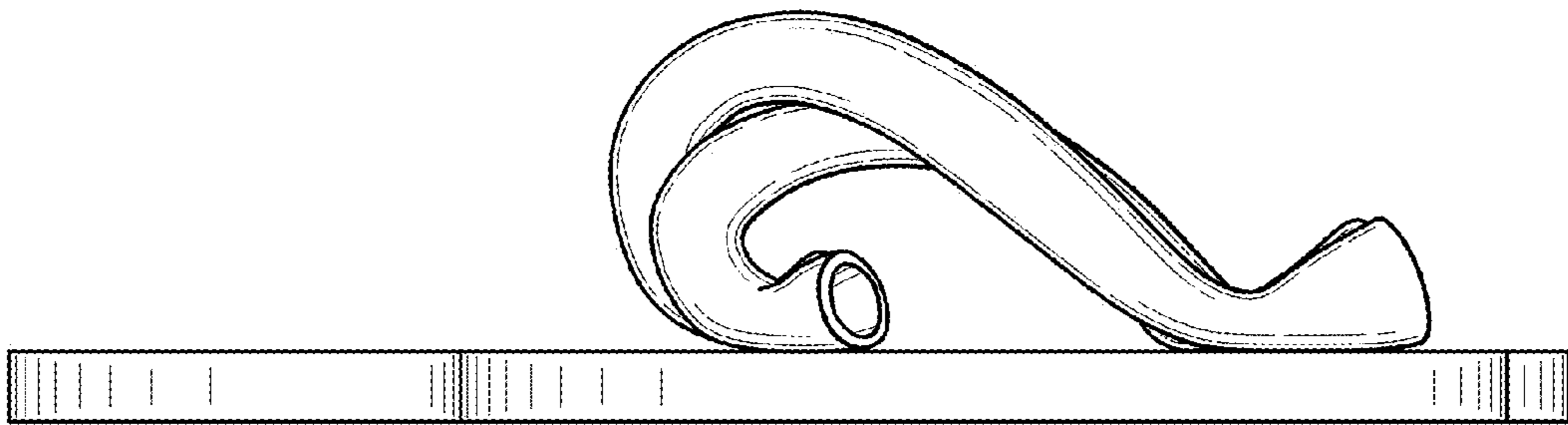

Fig. 19.

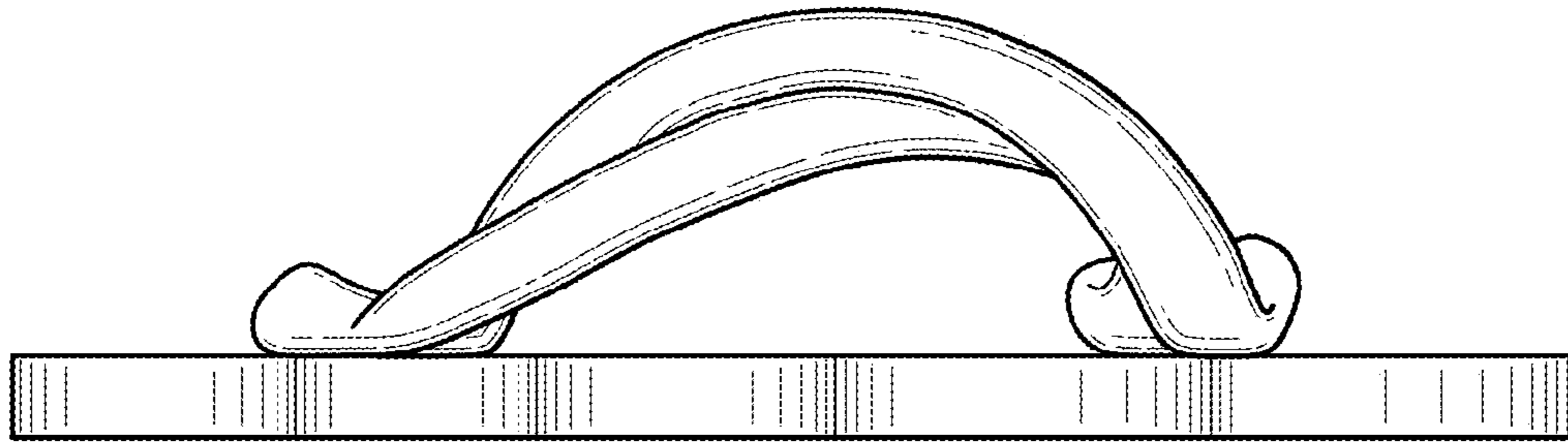

Fig. 20.

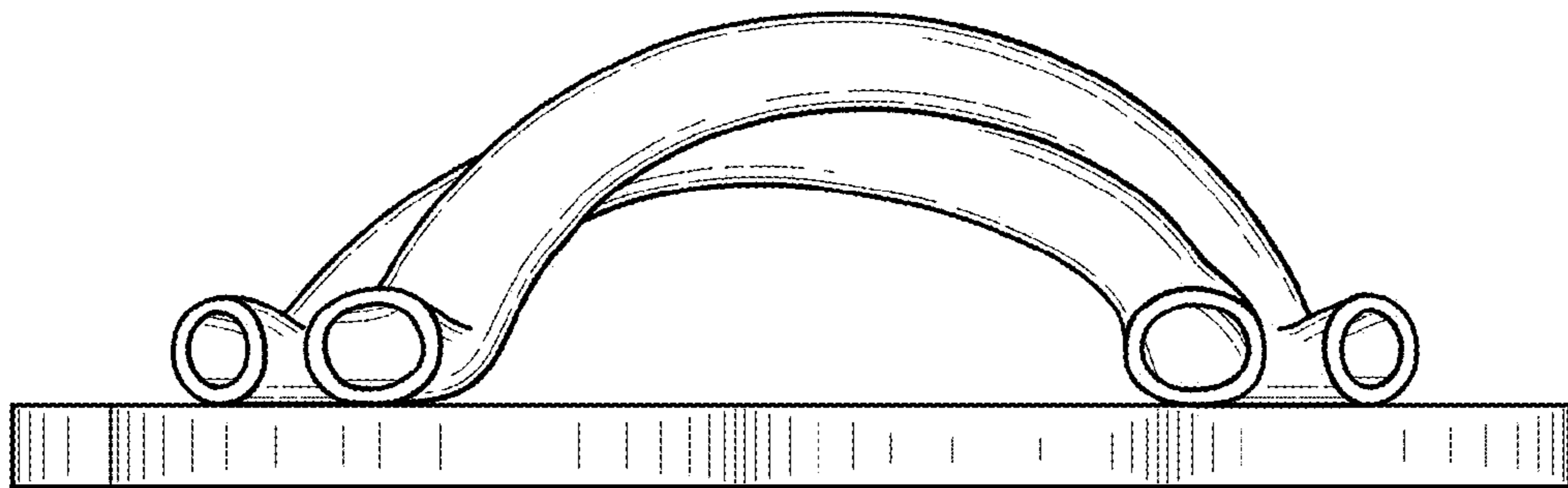

Fig. 21.

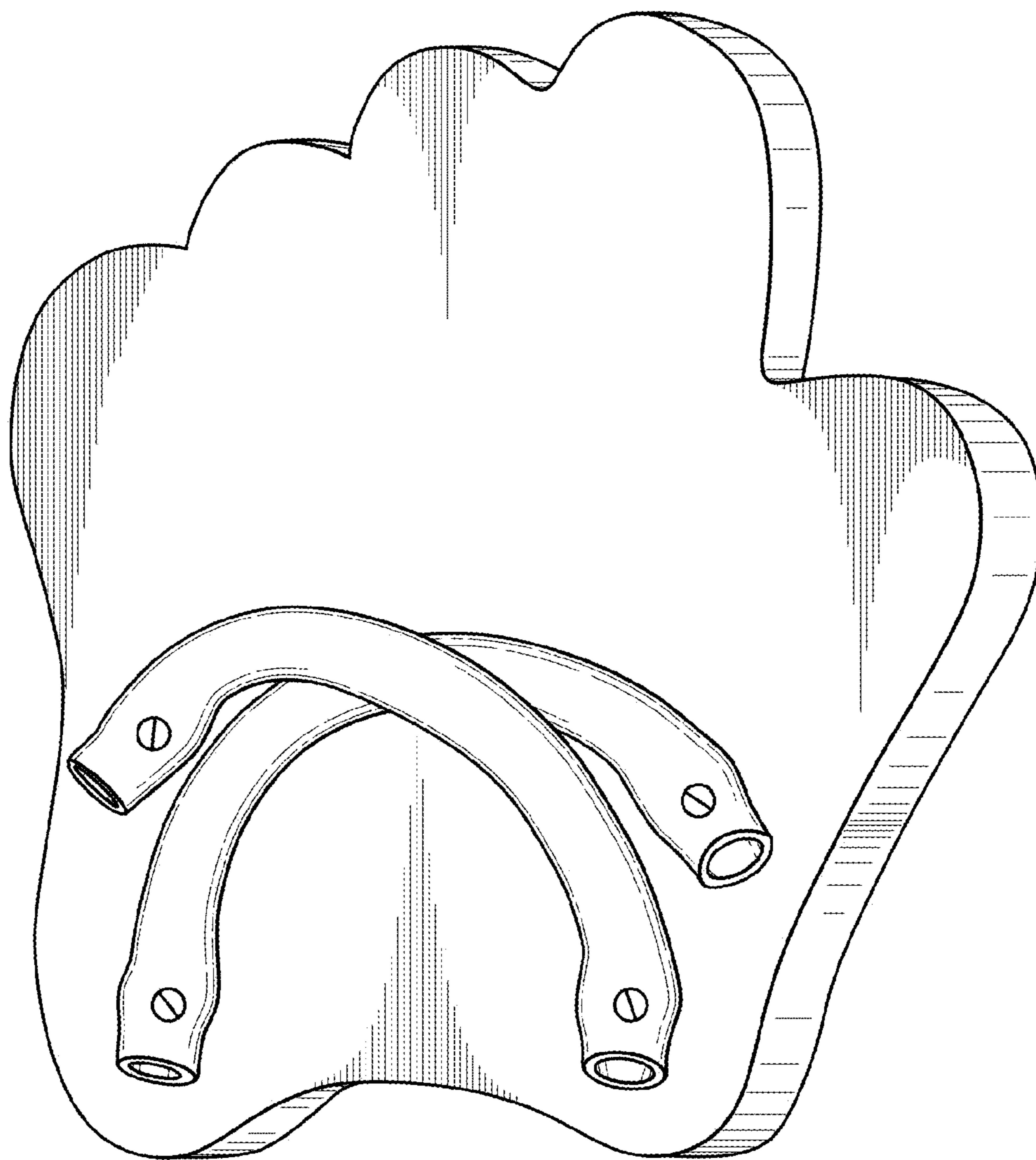

Fig. 22.

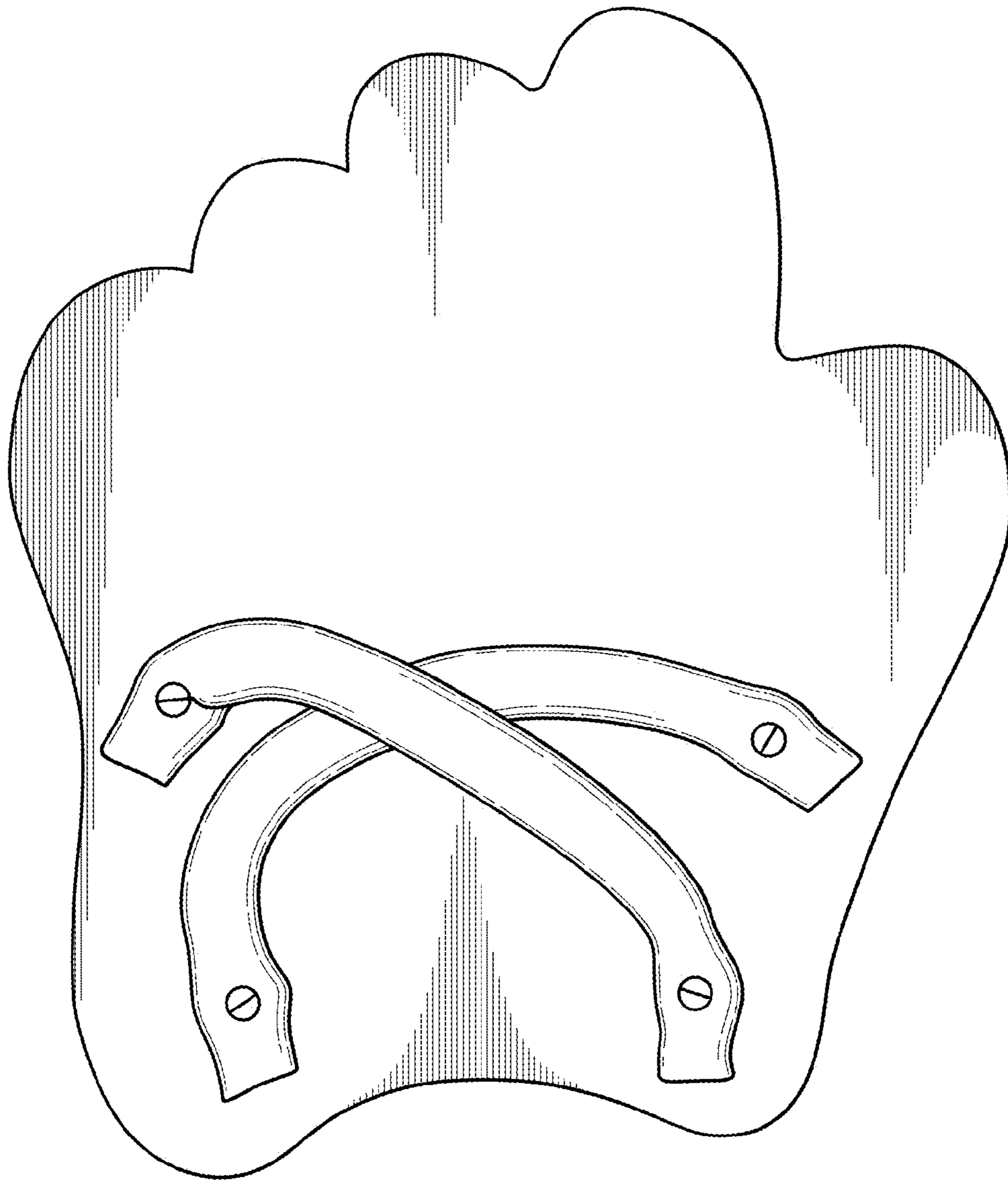

Fig. 23.

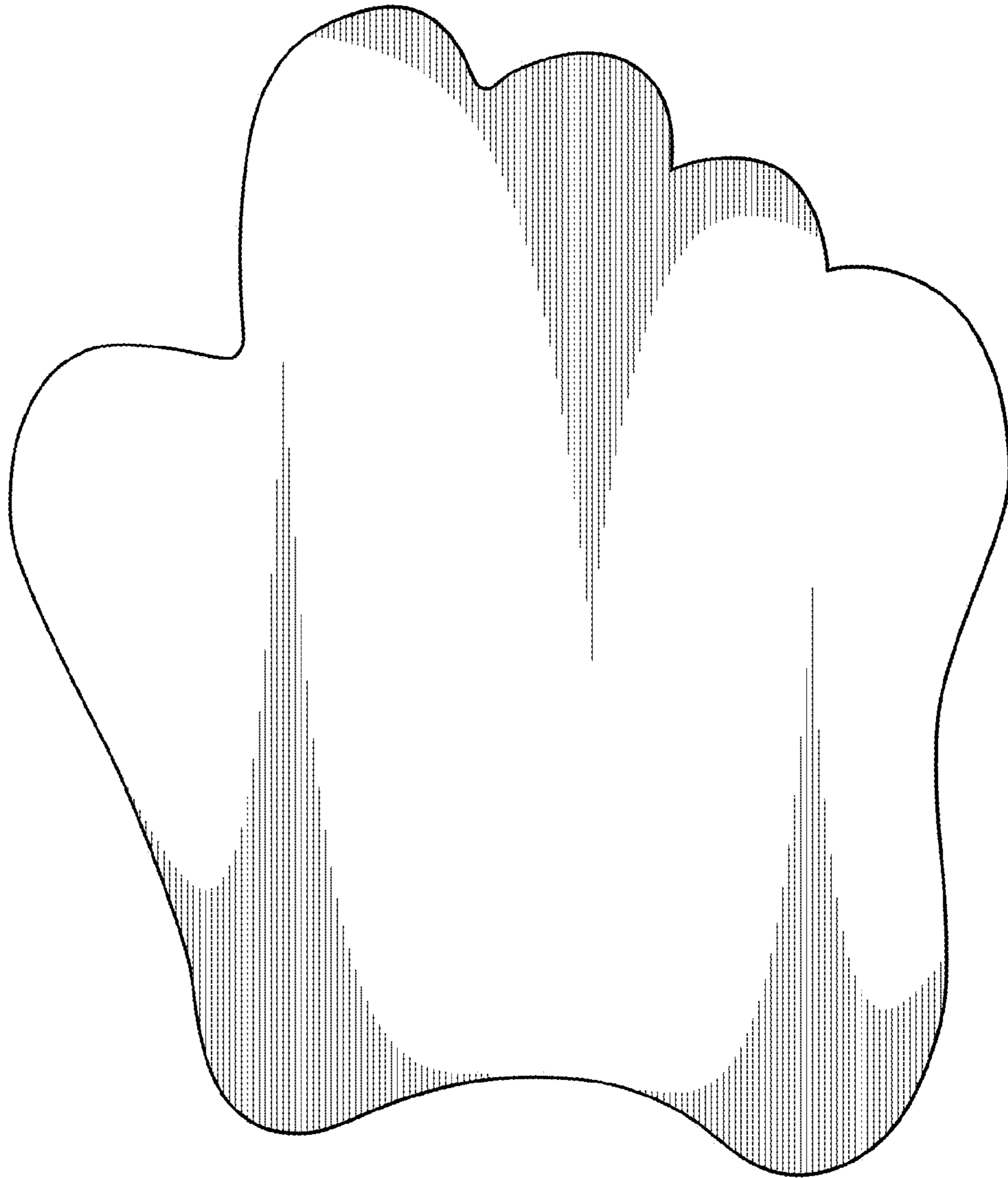

Fig. 24.

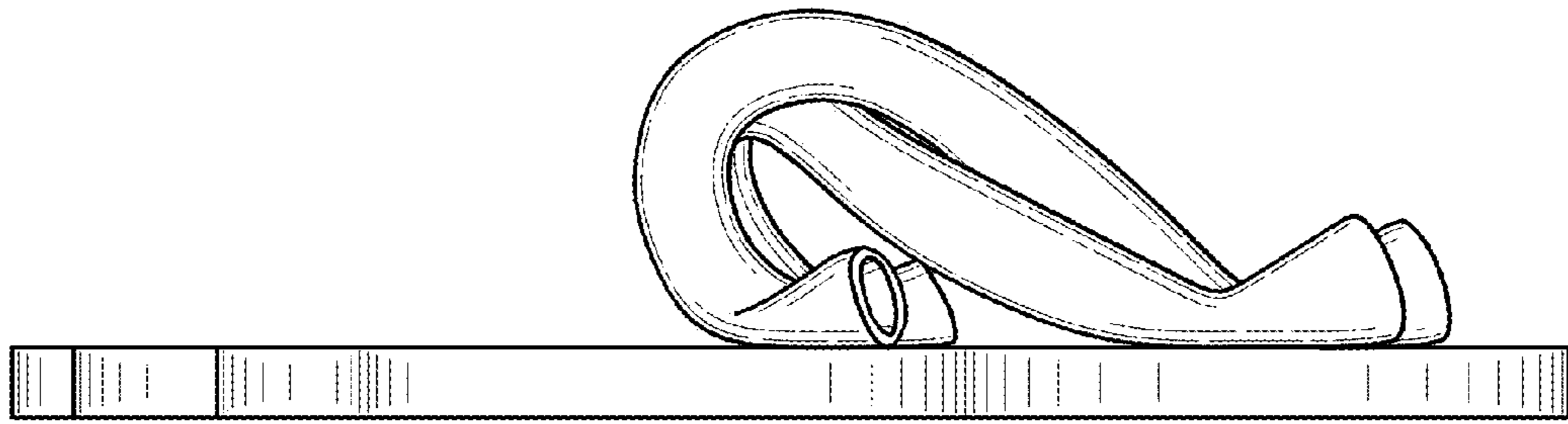

Fig. 25.

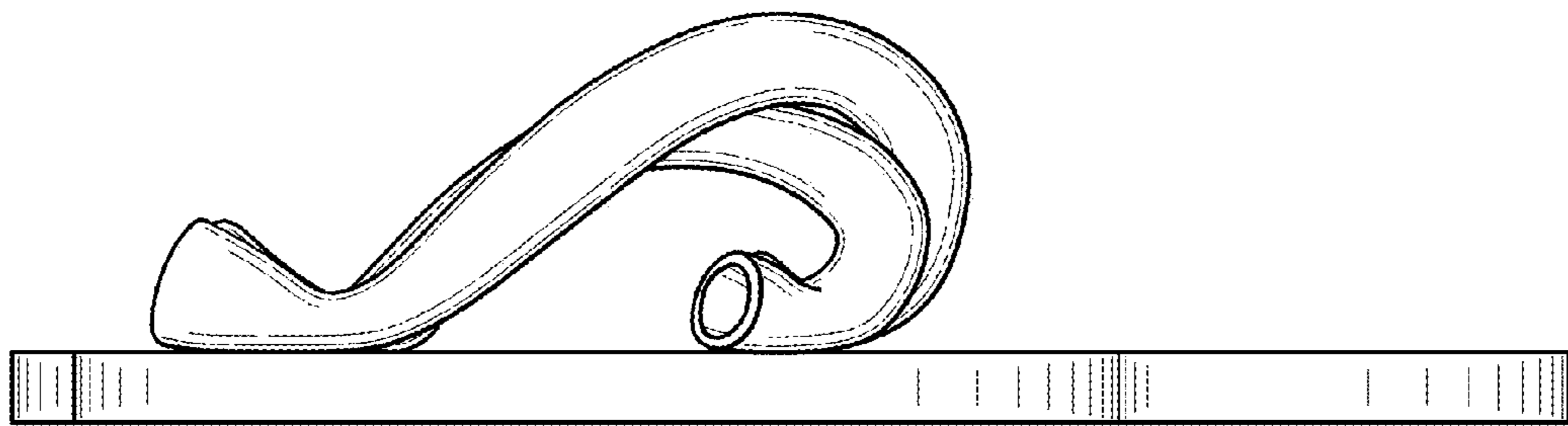

Fig. 26.

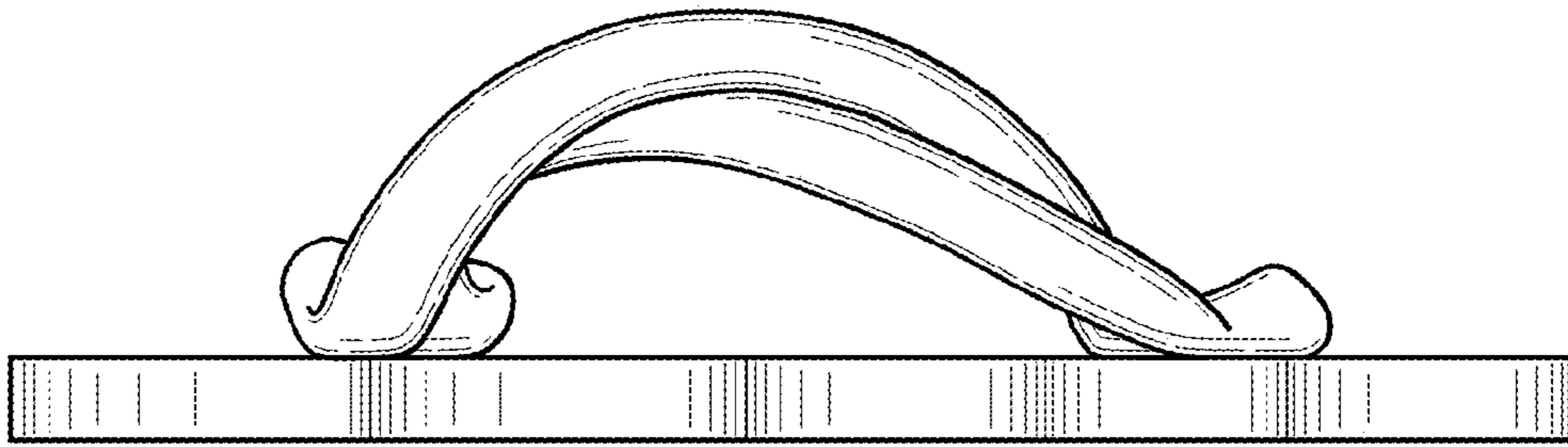

Fig. 27.

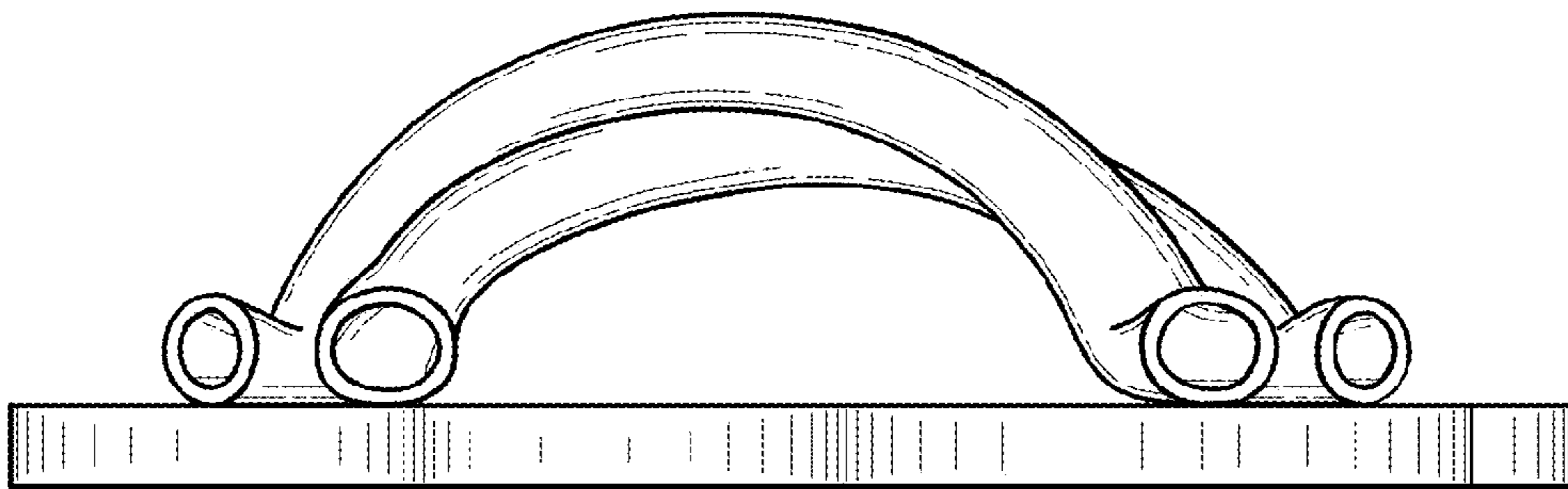

Fig. 28.