

US00D766996S

(12) **United States Design Patent**
Lee et al.

(10) **Patent No.:** **US D766,996 S**
(45) **Date of Patent:** **** Sep. 20, 2016**

(54) **REFRIGERATOR**

D722,089 S * 2/2015 Qiang D15/86
D735,779 S * 8/2015 Hwang D15/81
D747,367 S * 1/2016 Stolarz D15/81

(71) Applicant: **LG ELECTRONICS INC.**, Seoul
(KR)

OTHER PUBLICATIONS

(72) Inventors: **Jiyeon Lee**, Seoul (KR); **Jaeboem Im**,
Seoul (KR); **Jaewon Jeong**, Seoul
(KR); **Youngwoo Kim**, Seoul (KR);
Hyungsuk Cho, Seoul (KR)

U.S. Notice of Allowance issued in co-pending U.S. Appl. No.
29/531,324 issued on Jul. 29, 2016.

* cited by examiner

(73) Assignee: **LG ELECTRONICS INC.**, Seoul
(KR)

Primary Examiner — Daniel Bui
Assistant Examiner — Khawaja Anwar

(74) *Attorney, Agent, or Firm* — Ked & Associates LLP

(**) Term: **15 Years**

(21) Appl. No.: **29/531,313**

(57) **CLAIM**

We claim the ornamental design for a refrigerator, as shown
and described.

(22) Filed: **Jun. 25, 2015**

(30) **Foreign Application Priority Data**

DESCRIPTION

Jan. 16, 2015 (KR) 30-2015-0002354

(51) **LOC (10) Cl.** **15-07**

(52) **U.S. Cl.**
USPC **D15/86**

(58) **Field of Classification Search**
USPC D15/79–91
CPC F25D 23/028; F25D 23/02; F25D 25/025;
F25D 23/00; F25D 2323/021; F25D 11/00;
F25D 2323/024; F25D 23/04; F25D 29/00;
F25D 25/02; F25D 25/024; F25D 27/005;
F25D 23/12; F25D 29/005; F25D 17/042;
F25D 2325/021; F25D 2323/02
See application file for complete search history.

FIG. 1 is a perspective view of a refrigerator, without
internal environment, showing my new design;
FIG. 2 is a front elevation view thereof;
FIG. 3 is a rear elevation view thereof;
FIG. 4 is a left-side elevation view thereof;
FIG. 5 is a right-side elevation view thereof;
FIG. 6 is a top plan view thereof;
FIG. 7 is a bottom plan view thereof;
FIG. 8 is a another perspective view thereof, shown with
internal environment;
FIG. 9 is a perspective view thereof, shown in an alternate
configuration; and,
FIG. 10 is a perspective view thereof, shown in another
configuration.
The broken lines in the drawing figures are included for the
purpose of illustrating environment and form no part of the
claimed design.

(56) **References Cited**

U.S. PATENT DOCUMENTS

D607,019 S * 12/2009 Becke D15/87
D719,193 S * 12/2014 Park D15/79

1 Claim, 7 Drawing Sheets

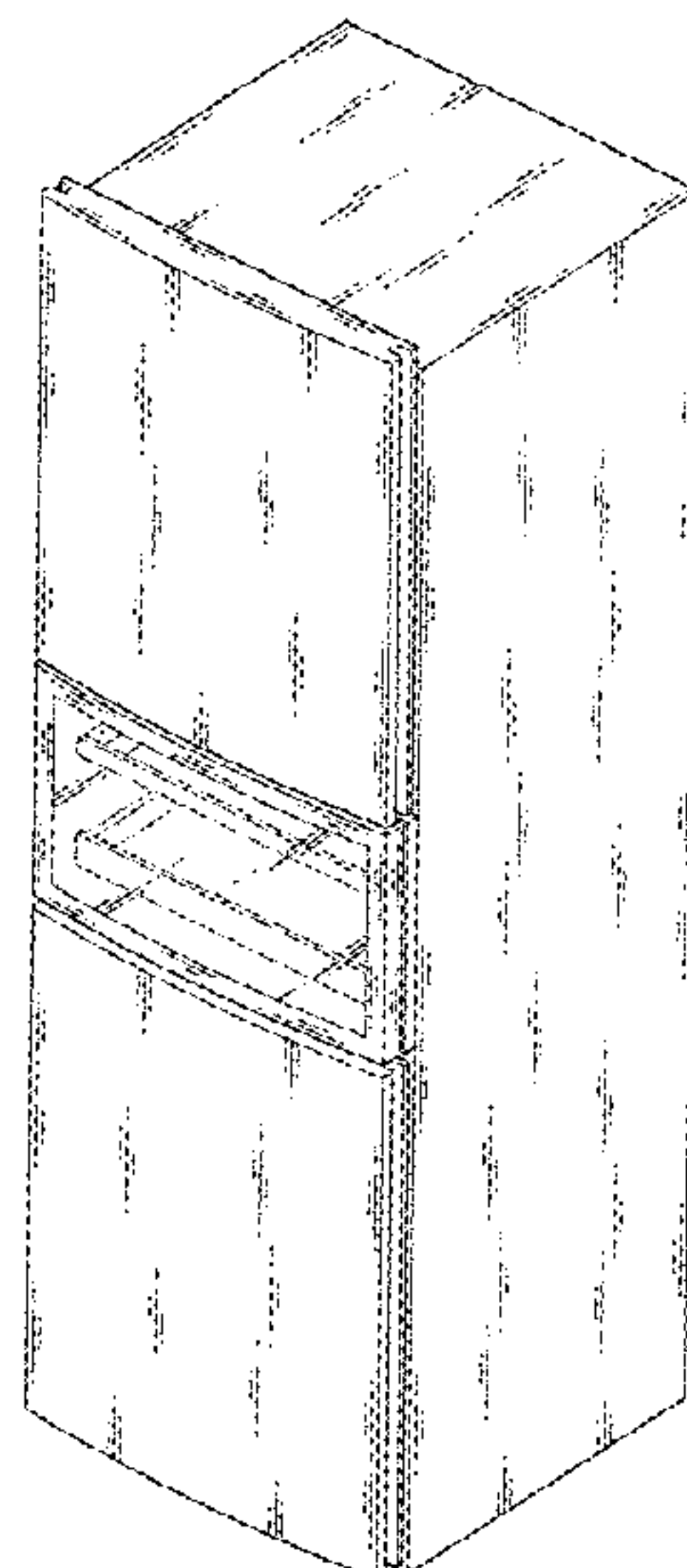
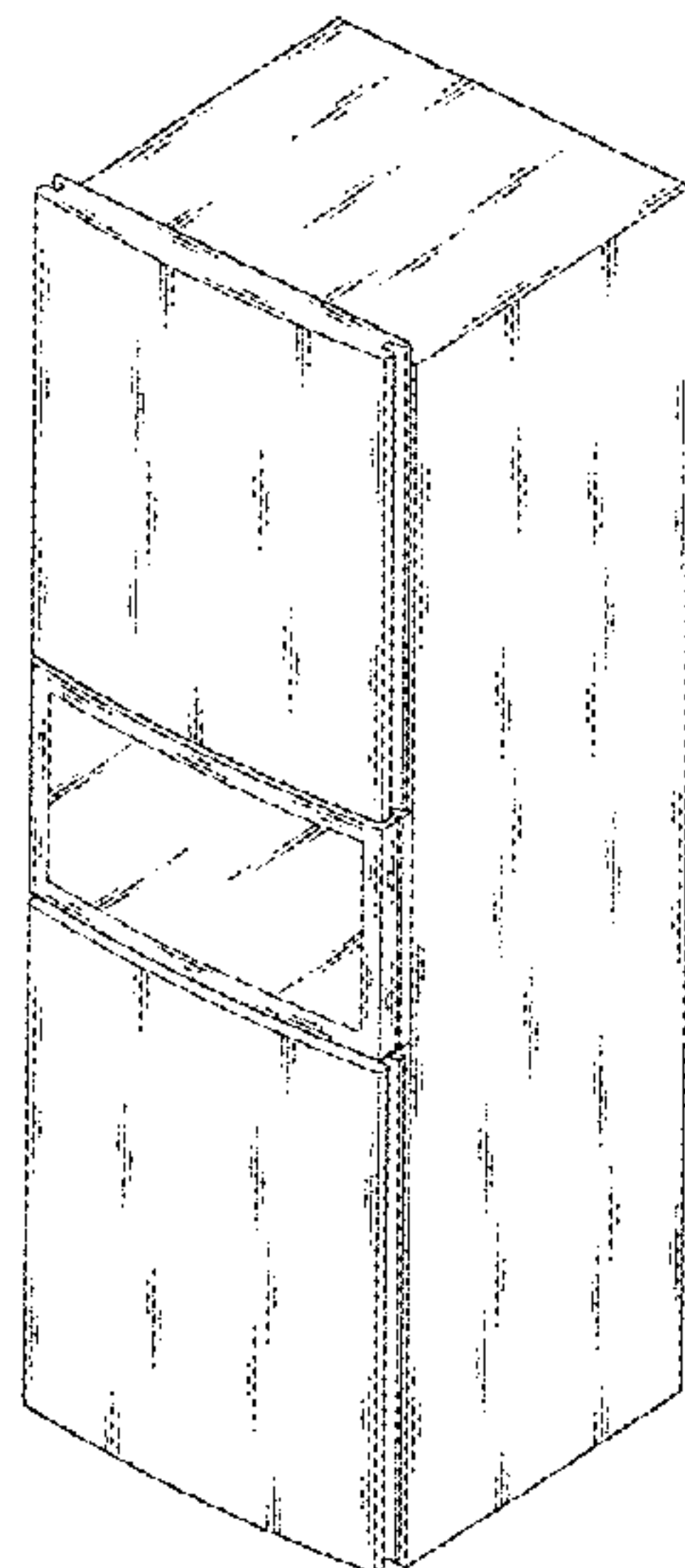

FIG. 1

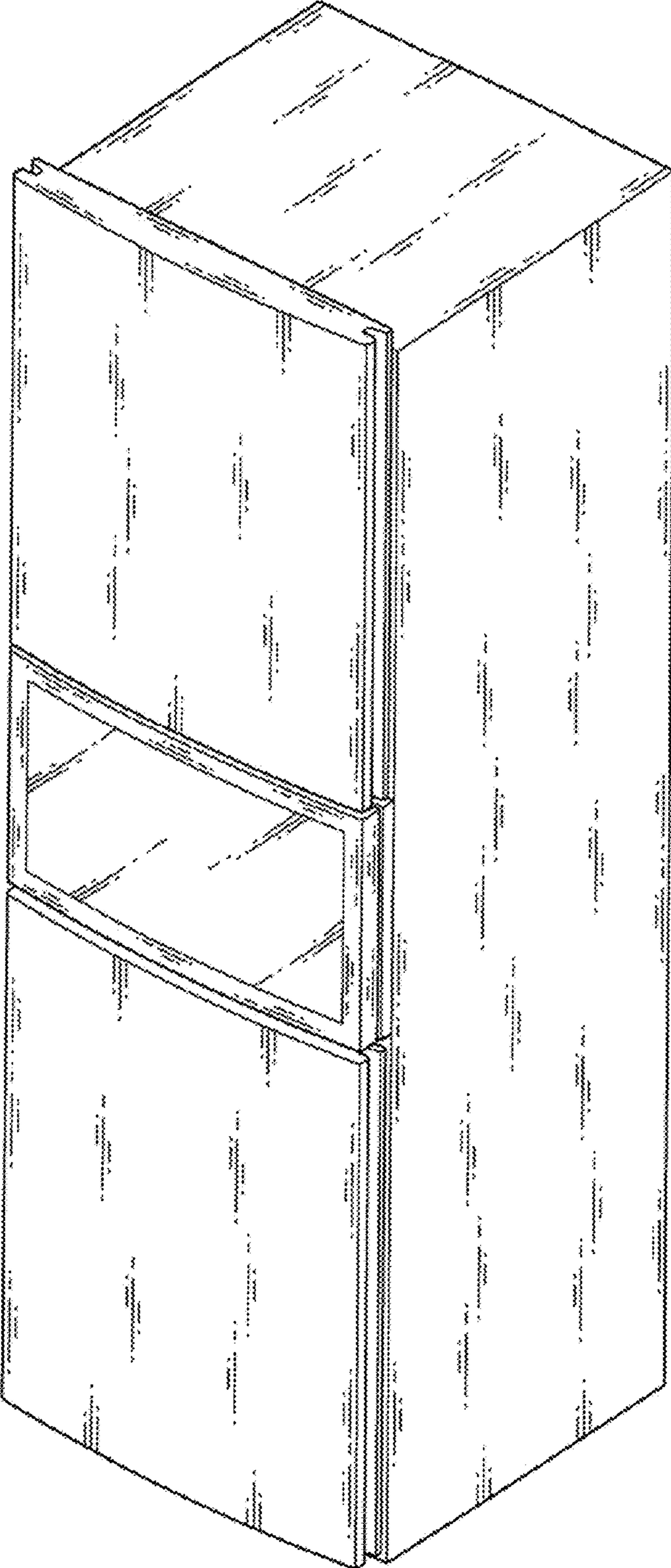

FIG. 2

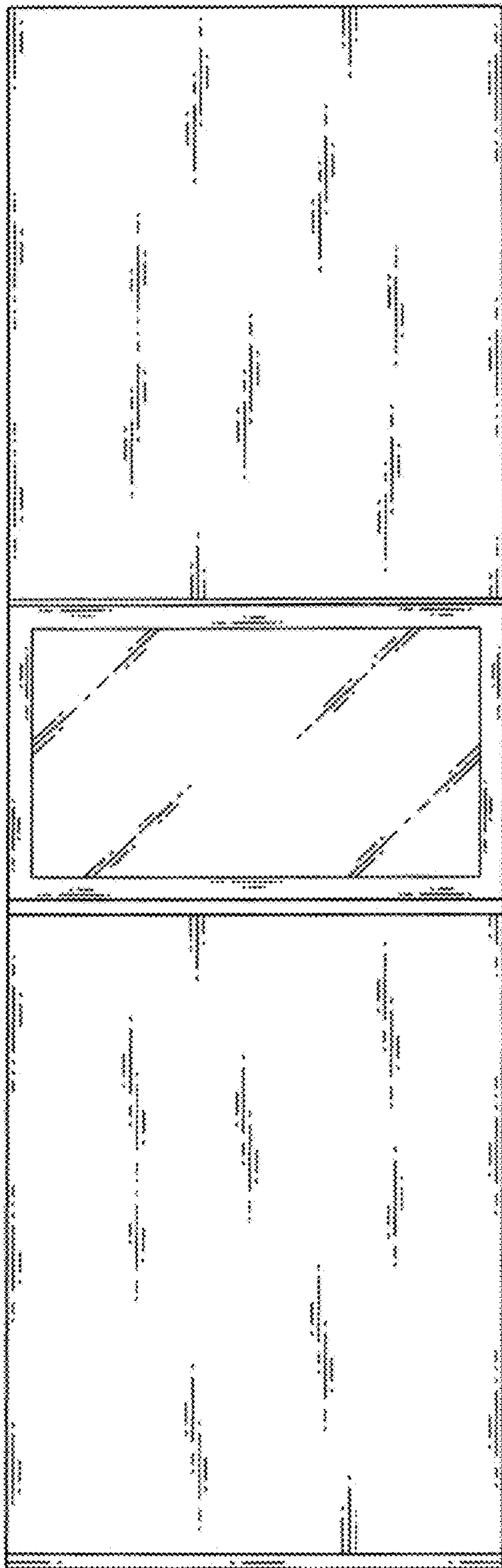

FIG. 3

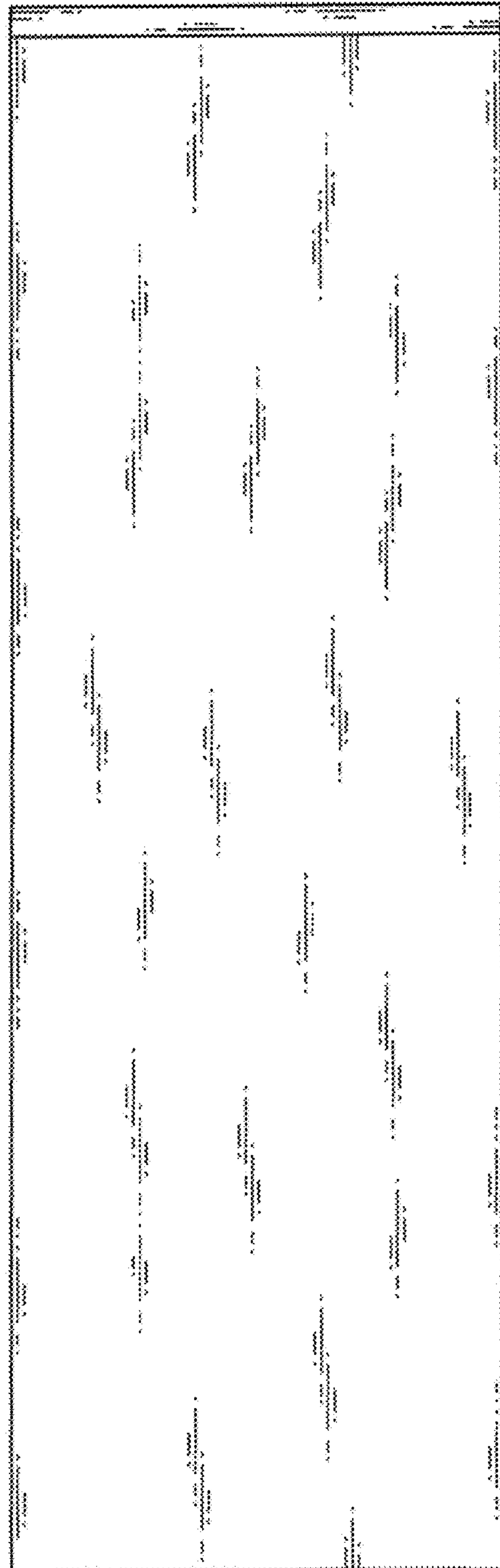

FIG. 4

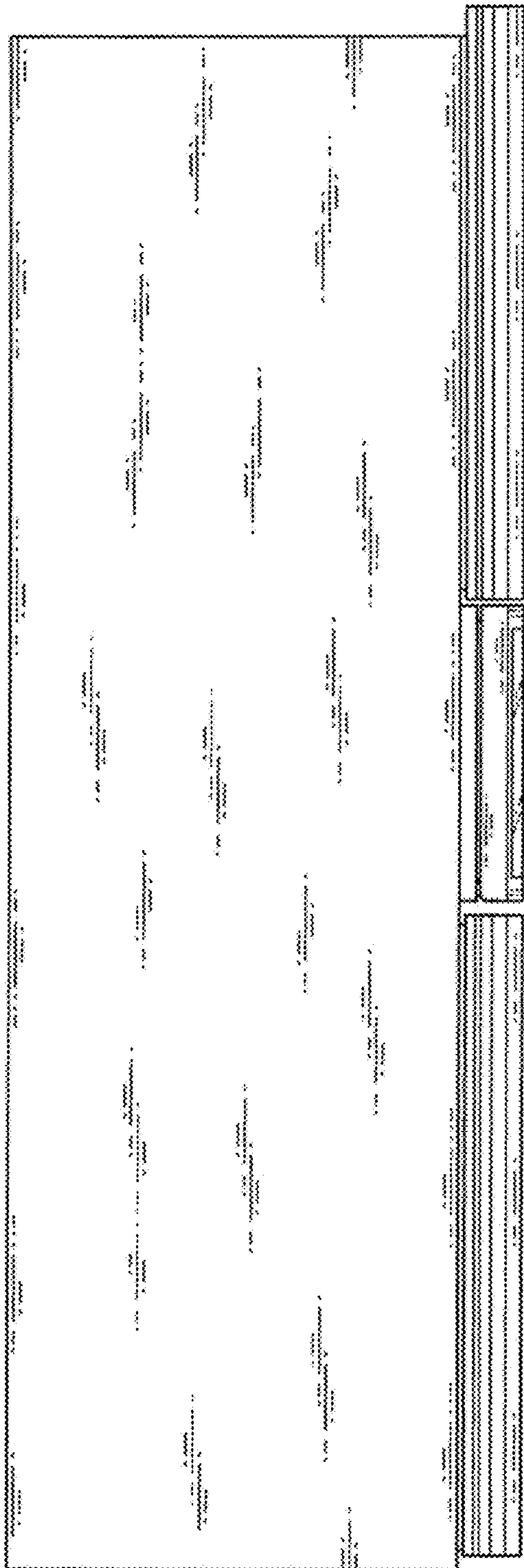

FIG. 5

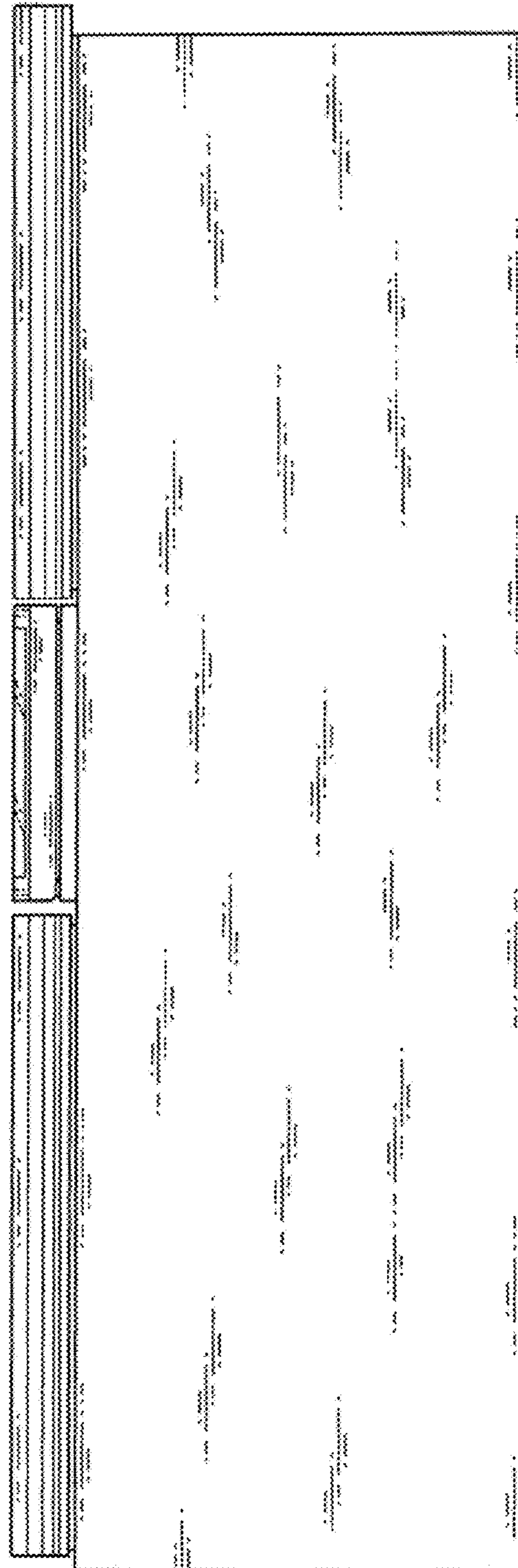

FIG. 6

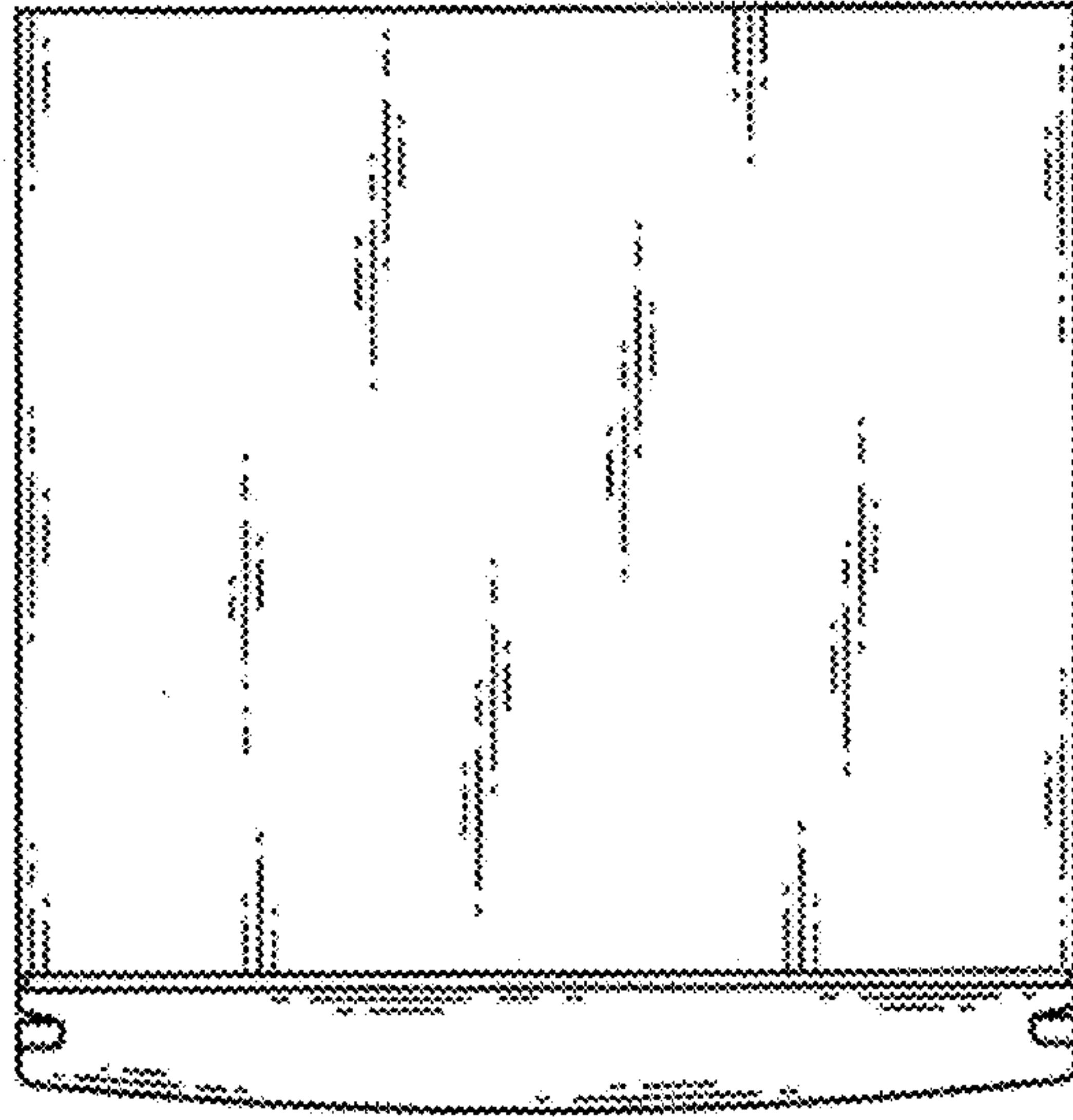

FIG. 7

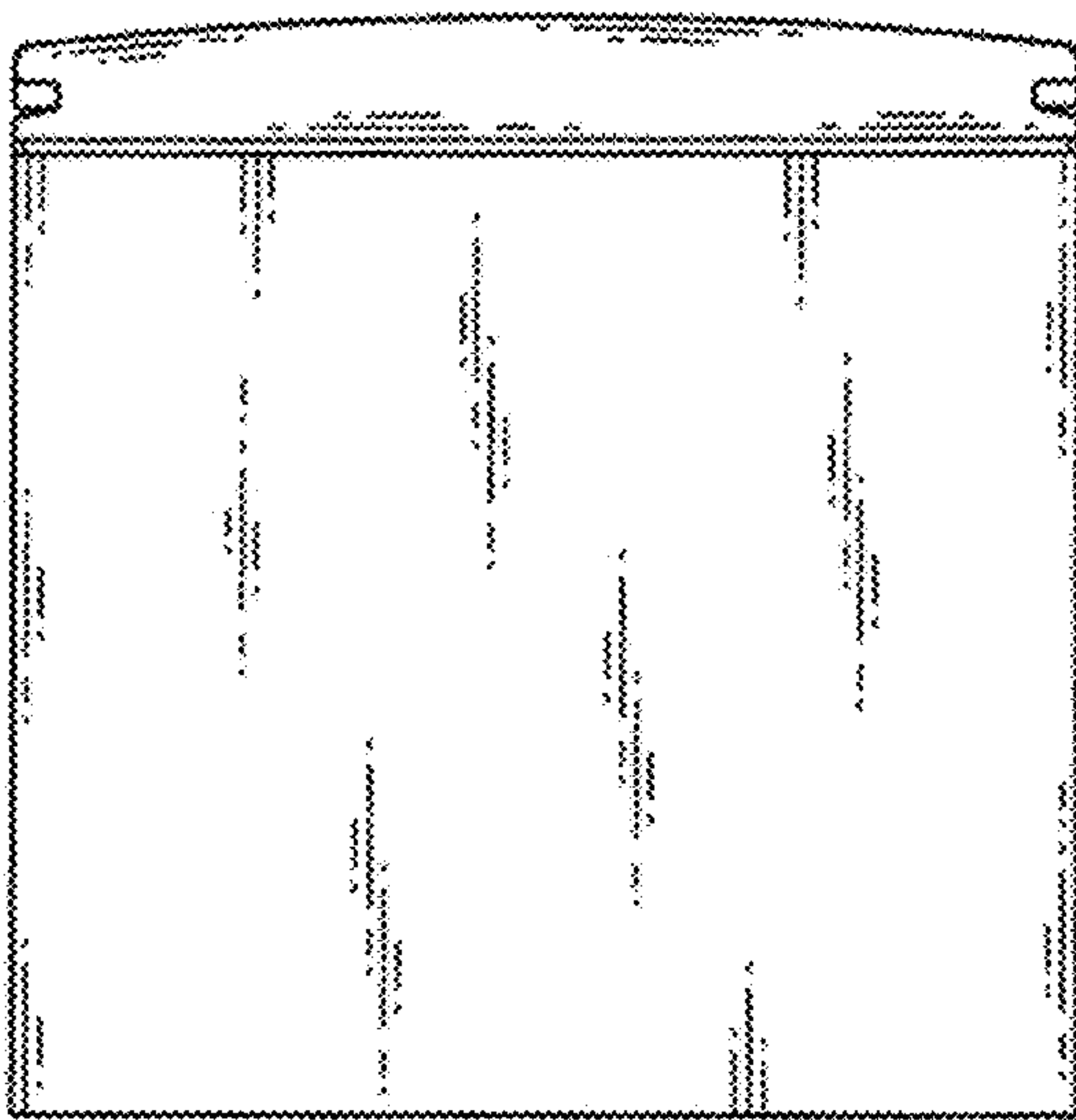

FIG. 8

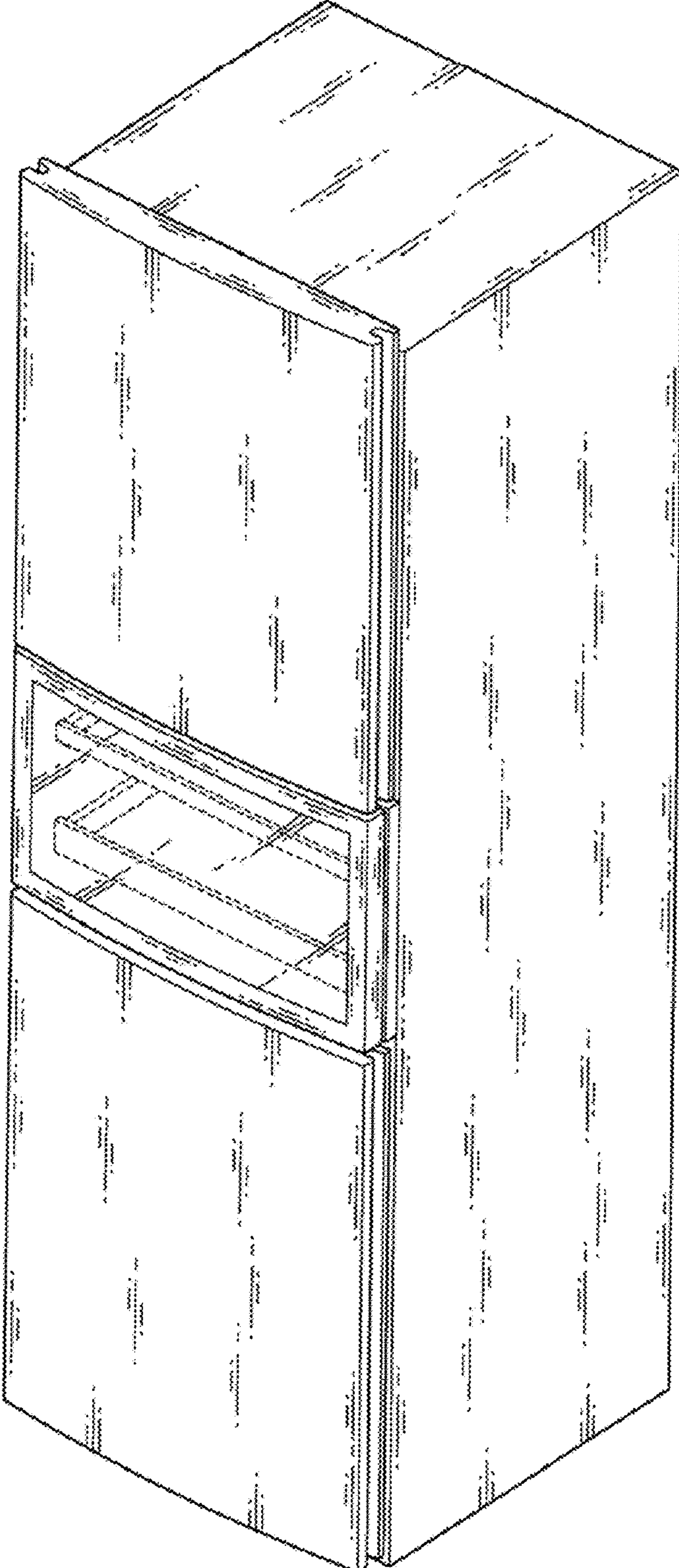

FIG. 9

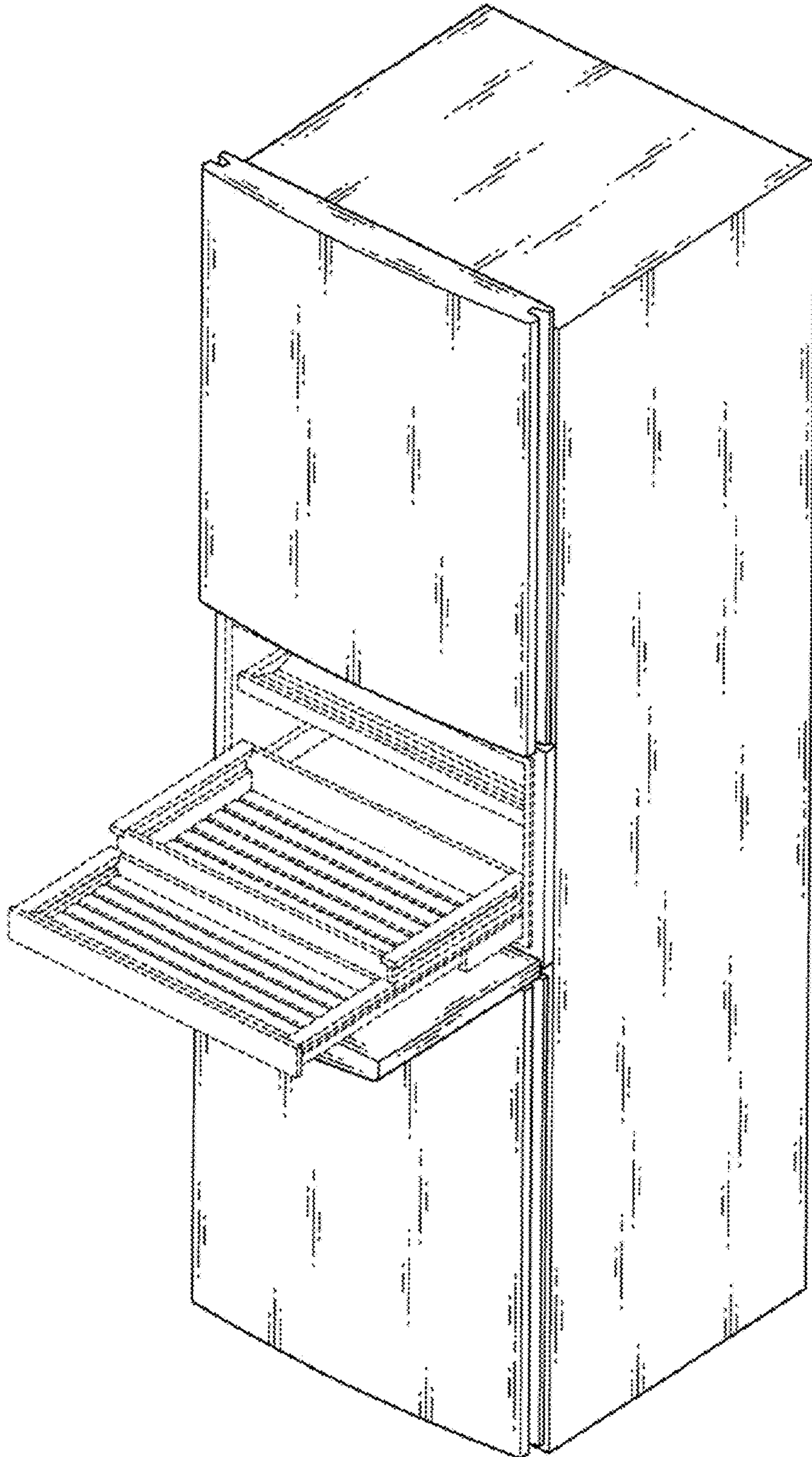

FIG. 10

