

US00D766781S

(12) **United States Design Patent** (10) **Patent No.:** **US D766,781 S**
Knopow et al. (45) **Date of Patent:** **** Sep. 20, 2016**

- (54) **AMBULATION AID**
 - (71) Applicant: **Motivo, Inc.**, Franklin, WI (US)
 - (72) Inventors: **Jeremy F. Knopow**, Burlington, WI (US); **Jennifer R. Harris**, Milwaukee, WI (US)
 - (73) Assignee: **MOTIVO, INC.**, Franklin, WI (US)
 - (**) Term: **14 Years**
 - (21) Appl. No.: **29/478,130**
 - (22) Filed: **Dec. 31, 2013**
 - (51) **LOC (10) Cl.** **12-12**
 - (52) **U.S. Cl.**
USPC **D12/130**
 - (58) **Field of Classification Search**
USPC D12/130
CPC A61H 3/00; A61H 3/04; A61H 2003/001-2003/007; A61H 2003/043; A61H 2003/046
- See application file for complete search history.

- 7,108,004 B2 9/2006 Cowie et al.
- D533,814 S * 12/2006 Kende D12/130
- 7,157,034 B2 1/2007 Bristow et al.
- 7,198,284 B2 4/2007 Cerreto et al.
- 7,559,560 B2 7/2009 Li et al.
- 7,866,677 B1 1/2011 Rothstein et al.
- 8,434,780 B2 5/2013 Li
- 8,602,185 B1 * 12/2013 White A61H 3/04
135/66

OTHER PUBLICATIONS

Invacare Corporation, "Personal Care Products", 2001, 32 Pages. Scooterville, "Runabout Folding Rollator (SC808)" retrieved from the internet: <http://www.scooterville.com/Scooterville_Runabout_Folding_Rollator_%28SC808%29/p/41726/c/669/>, last visited Jul. 29, 2013, 2 pages.

Eurovema, "Volaris 1422150 S7 Rollator", retrieved from the internet: <<http://www.volaris.se/default.asp?M=100000002&L=EN>>, last visited Jul. 29, 2013, 1 page.

Breeze by Access, "Breeze", retrieved from the internet: <<http://www.breeze-walker.com/>>, last visited Jul. 29, 2013, 2 page.

Active by Access, "Active", retrieved from the internet: <<http://www.active-walker.com/usa/home>>, last visited Jul. 29, 2013, 1 page.

Invacare Corporation, "Dolomite" retrieved from the internet: <<http://www.dolomite.biz/>>, last visited Jul. 29, 2013, 1 page.

United States Patent and Trademark Office, "Non-Final Office Action," issued in connection with U.S. Appl. No. 29/495,383, mailed on Sep. 11, 2015, 18 pages.

United States Patent and Trademark Office, "Final Office Action", issued in connection with U.S. Appl. No. 29/495,383, mailed on Feb. 9, 2016, 11 pages.

United States Patent and Trademark Office, Notice of Allowance, issued in connection with U.S. Appl. No. 29/495,383, mailed on Apr. 26, 2016, 12 pages.

(56) **References Cited**
U.S. PATENT DOCUMENTS

- 268,238 A 11/1882 Johnson
- 320,462 A 6/1885 Cowing
- 673,100 A 4/1901 Tyler
- 1,394,224 A 10/1921 Scott
- 1,448,783 A 3/1923 Blewitt et al.
- 1,802,323 A 4/1931 Aulmann
- 2,205,978 A * 6/1940 Hoag A61H 3/04
297/5
- 2,278,901 A 4/1942 Smock
- 2,305,249 A 12/1942 Frost
- 2,437,778 A 3/1948 Ames
- 2,667,914 A 2/1954 Forbes
- 2,745,465 A 5/1956 Hogan
- 2,796,916 A 6/1957 Womble
- 2,817,387 A 12/1957 Blake
- 4,029,311 A 6/1977 Chanslor et al.
- D315,702 S * 3/1991 Van Dyke D12/133
- 5,529,425 A 6/1996 Spies et al.
- 5,692,762 A 12/1997 Obitts
- D397,644 S 9/1998 Douglass
- 6,014,981 A 1/2000 Douglass
- D503,130 S * 3/2005 Bourget D12/130
- 7,040,637 B2 5/2006 Owens et al.

* cited by examiner

Primary Examiner — Charles Hanson
(74) *Attorney, Agent, or Firm* — Hanley, Flight & Zimmerman, LLC

(57) **CLAIM**
The ornamental design for "ambulation aid," as shown and described.

DESCRIPTION

FIG. 1 is a first isometric view of an ambulation aid.
FIG. 2 is a front view of the ambulation aid of FIG. 1.

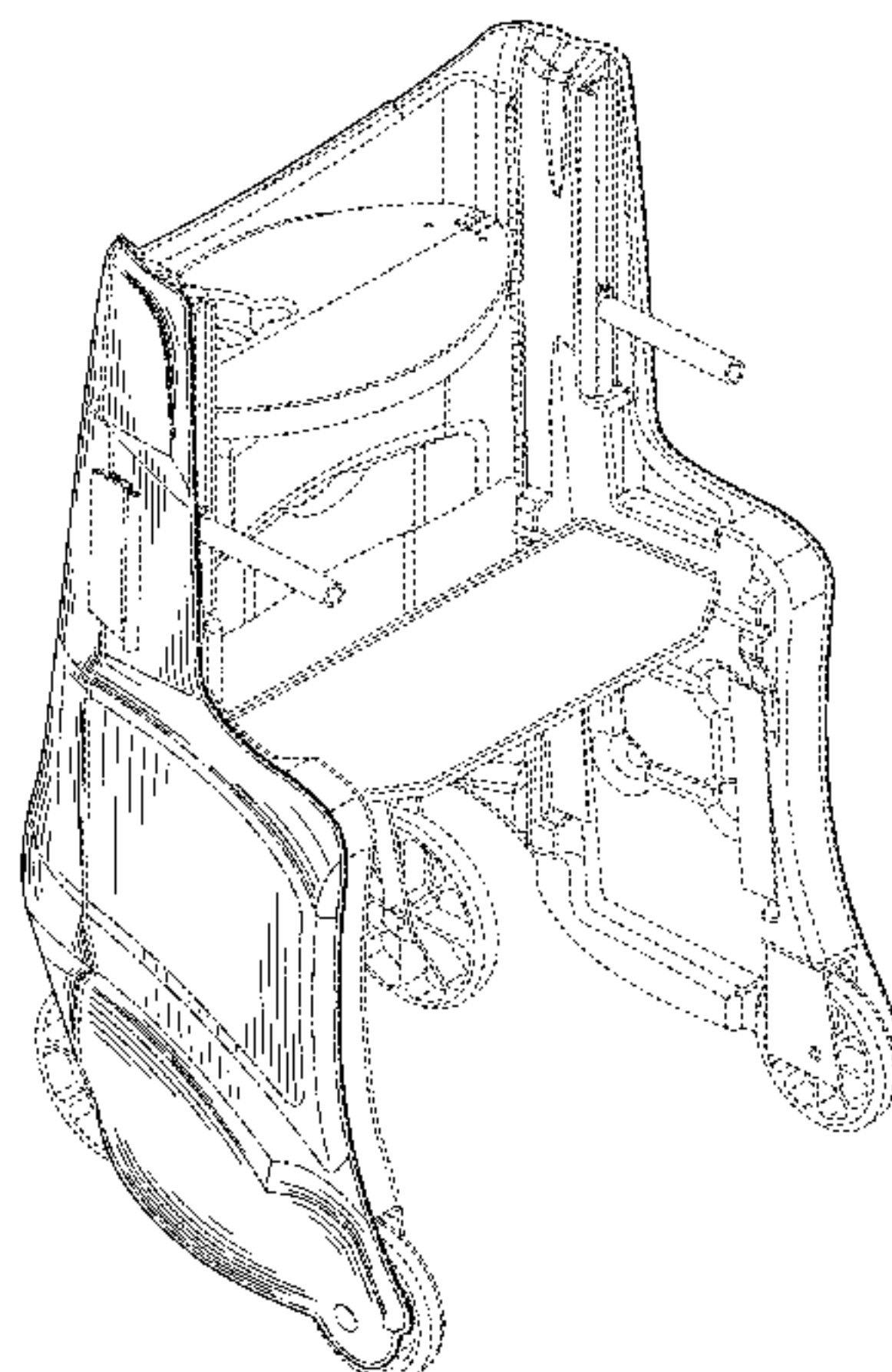

FIG. 3 is a rear view of the ambulation aid of FIG. 1.
FIG. 4 is a first side view of the ambulation aid of FIG. 1.
FIG. 5 is a second side view of the ambulation aid of FIG. 1.
FIG. 6 is a top view of the ambulation aid of FIG. 1.
FIG. 7 is a bottom view of the ambulation aid of FIG. 1.
FIG. 8 is a second isometric view of the ambulation aid of FIG. 1.
FIG. 9 is a first isometric view of an ambulation aid.
FIG. 10 is a front view of the ambulation aid of FIG. 9.
FIG. 11 is a rear view of the ambulation aid of FIG. 9.
FIG. 12 is a first side view of the ambulation aid of FIG. 9.
FIG. 13 is a second side view of the ambulation aid of FIG. 9.
FIG. 14 is a top view of the ambulation aid of FIG. 9.
FIG. 15 is a bottom view of the ambulation aid of FIG. 9.
FIG. 16 is a second isometric view of the ambulation aid of FIG. 9.
FIG. 17 is a first isometric view of an ambulation aid.
FIG. 18 is a front view of the ambulation aid of FIG. 17.
FIG. 19 is a rear view of the ambulation aid of FIG. 17.
FIG. 20 is a first side view of the ambulation aid of FIG. 17.
FIG. 21 is a second side view of the ambulation aid of FIG. 17.
FIG. 22 is a top view of the ambulation aid of FIG. 17.
FIG. 23 is a bottom view of the ambulation aid of FIG. 17.
FIG. 24 is a second isometric view of the ambulation aid of FIG. 17.

FIG. 25 is a first isometric view of an ambulation aid.
FIG. 26 is a front view of the ambulation aid of FIG. 25.
FIG. 27 is a rear view of the ambulation aid of FIG. 25.
FIG. 28 is a first side view of the ambulation aid of FIG. 25.
FIG. 29 is a second side view of the ambulation aid of FIG. 25.
FIG. 30 is a top view of the ambulation aid of FIG. 25.
FIG. 31 is a bottom view of the ambulation aid of FIG. 25.
FIG. 32 is a second isometric view of the ambulation aid of FIG. 25.
FIG. 33 is a first isometric view of an ambulation aid.
FIG. 34 is a front view of the ambulation aid of FIG. 33.
FIG. 35 is a rear view of the ambulation aid of FIG. 33.
FIG. 36 is a first side view of the ambulation aid of FIG. 33.
FIG. 37 is a second side view of the ambulation aid of FIG. 33.
FIG. 38 is a top view of the ambulation aid of FIG. 33.
FIG. 39 is a bottom view of the ambulation aid of FIG. 33;
and,
FIG. 40 is a second isometric view of the ambulation aid of FIG. 33.
The features shown in broken lines represent structural components of the ambulation aid, for example. The features shown in broken lines form no part of the claimed design. The features shown in dot/dashed lines represent contouring of the ambulation aid, for example. The features shown in dot/dashed lines form no part of the claimed design.

1 Claim, 40 Drawing Sheets

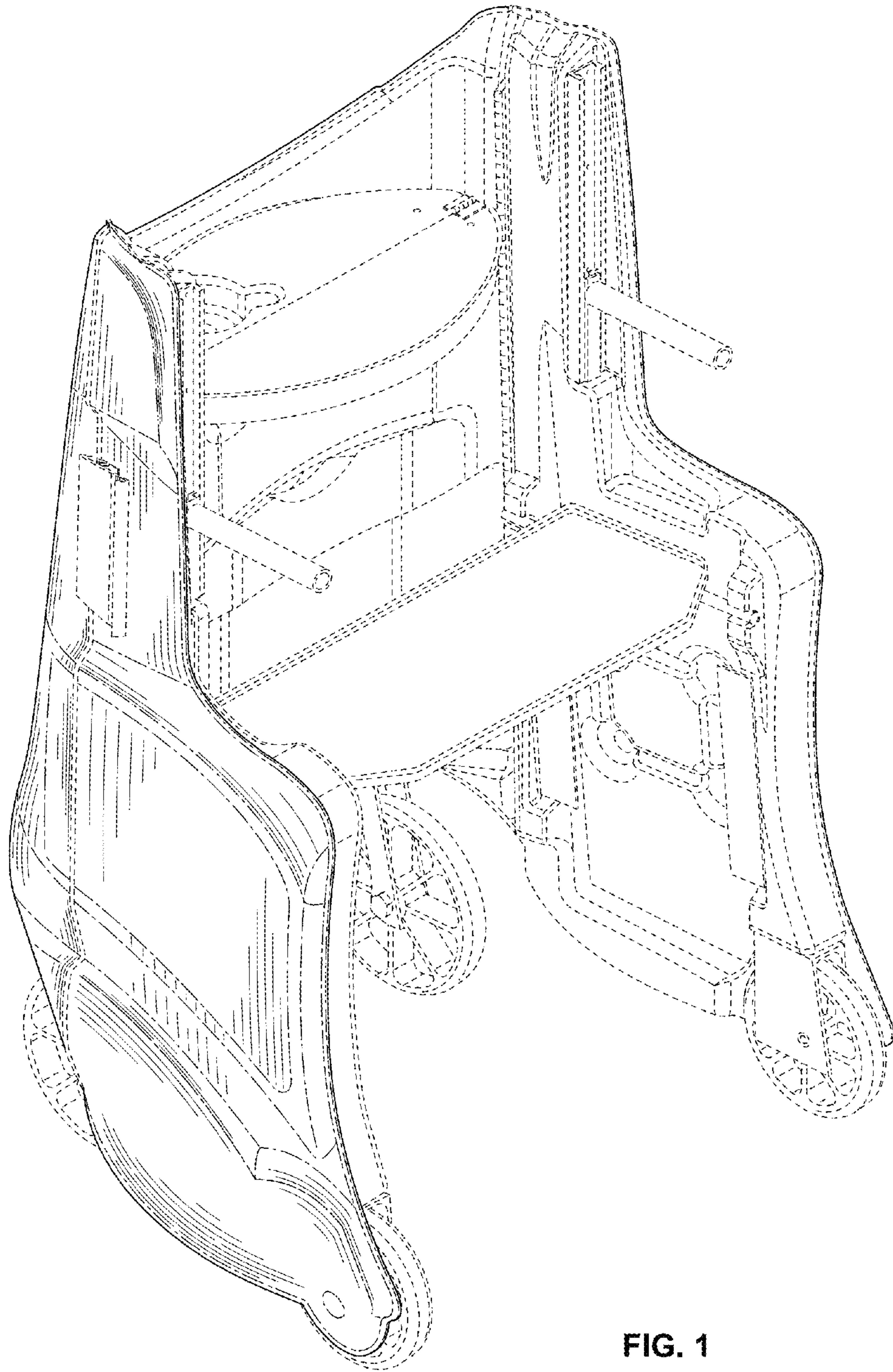

FIG. 1

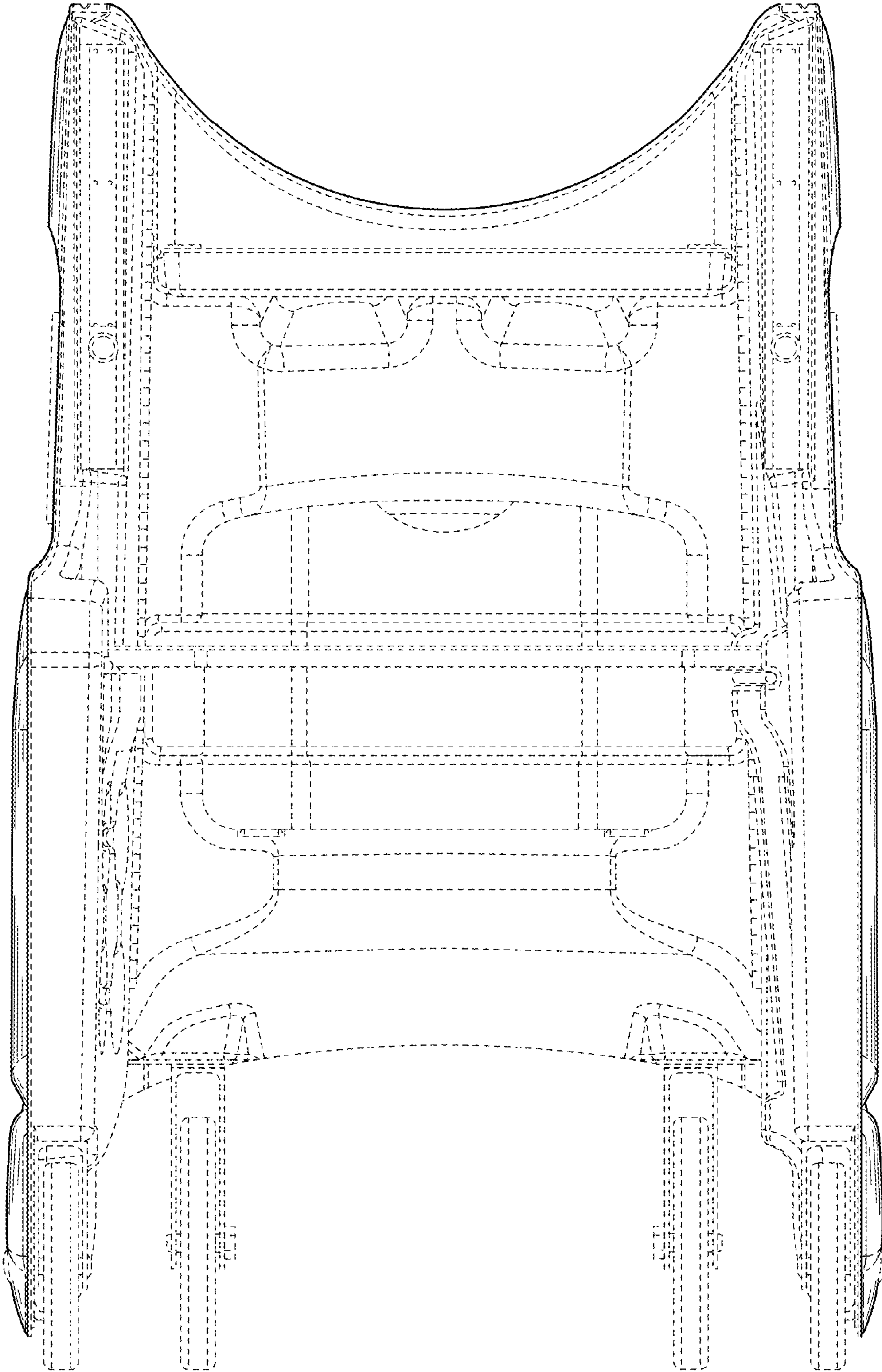

FIG. 2

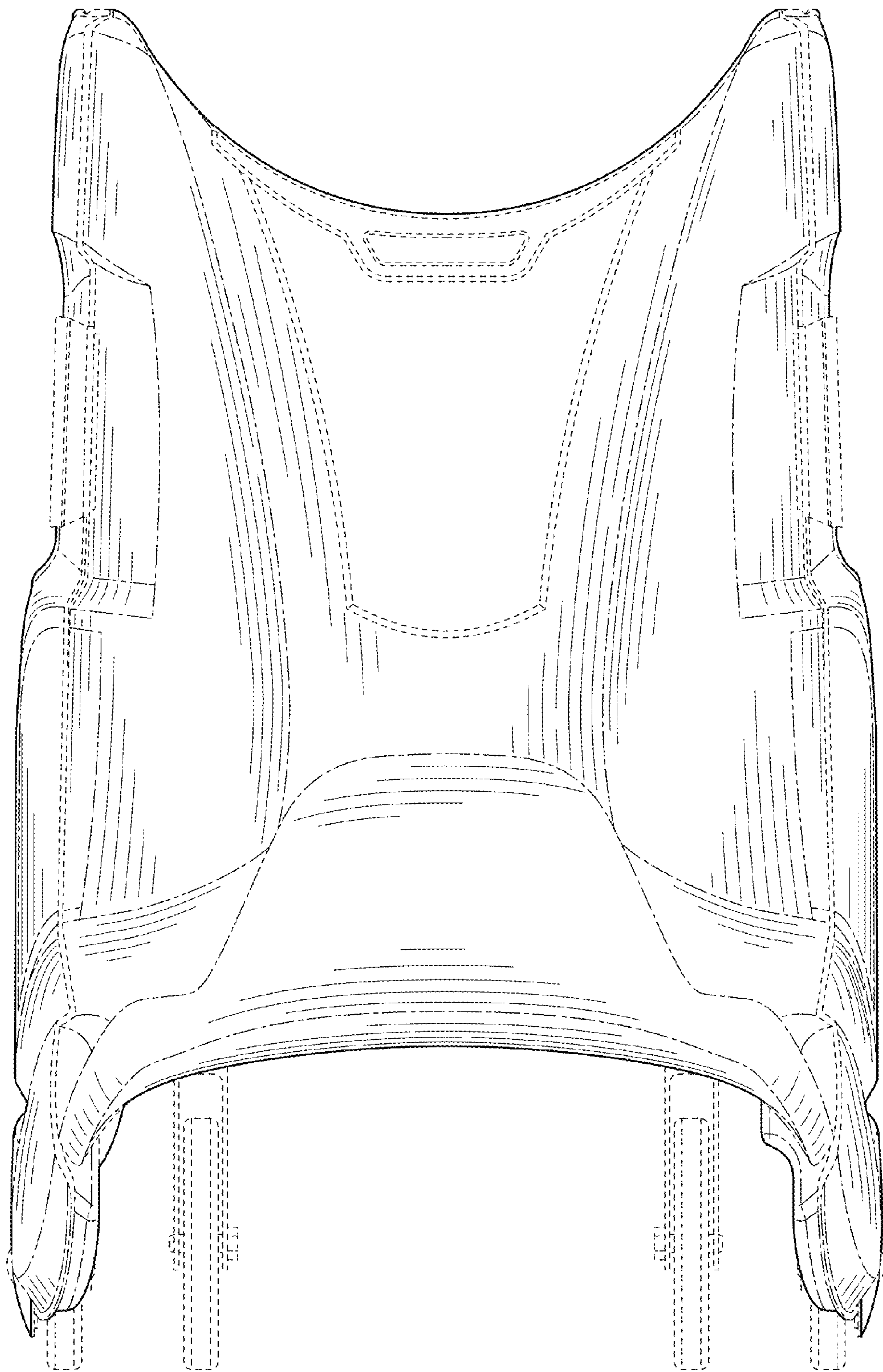

FIG. 3

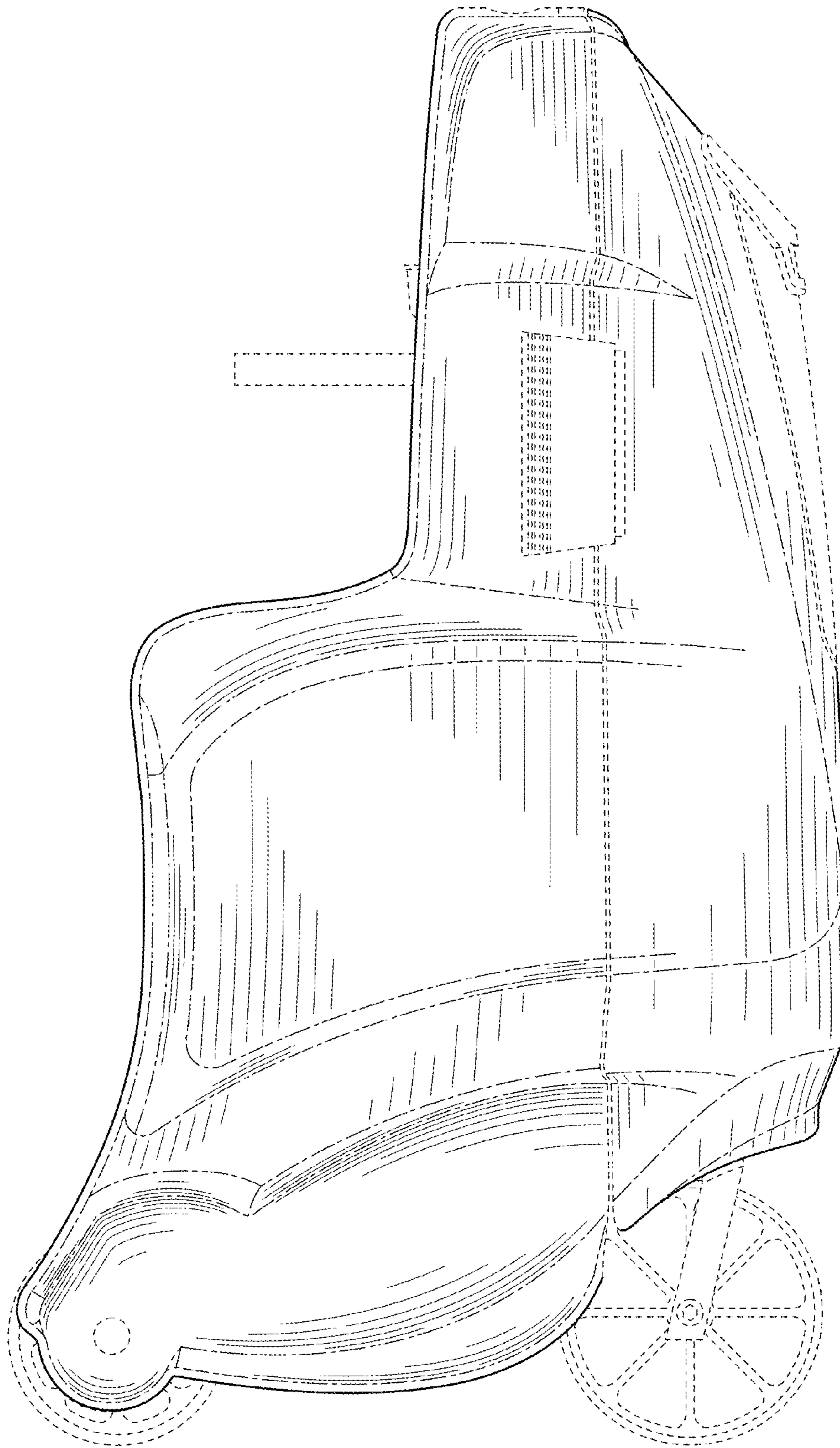

FIG. 4

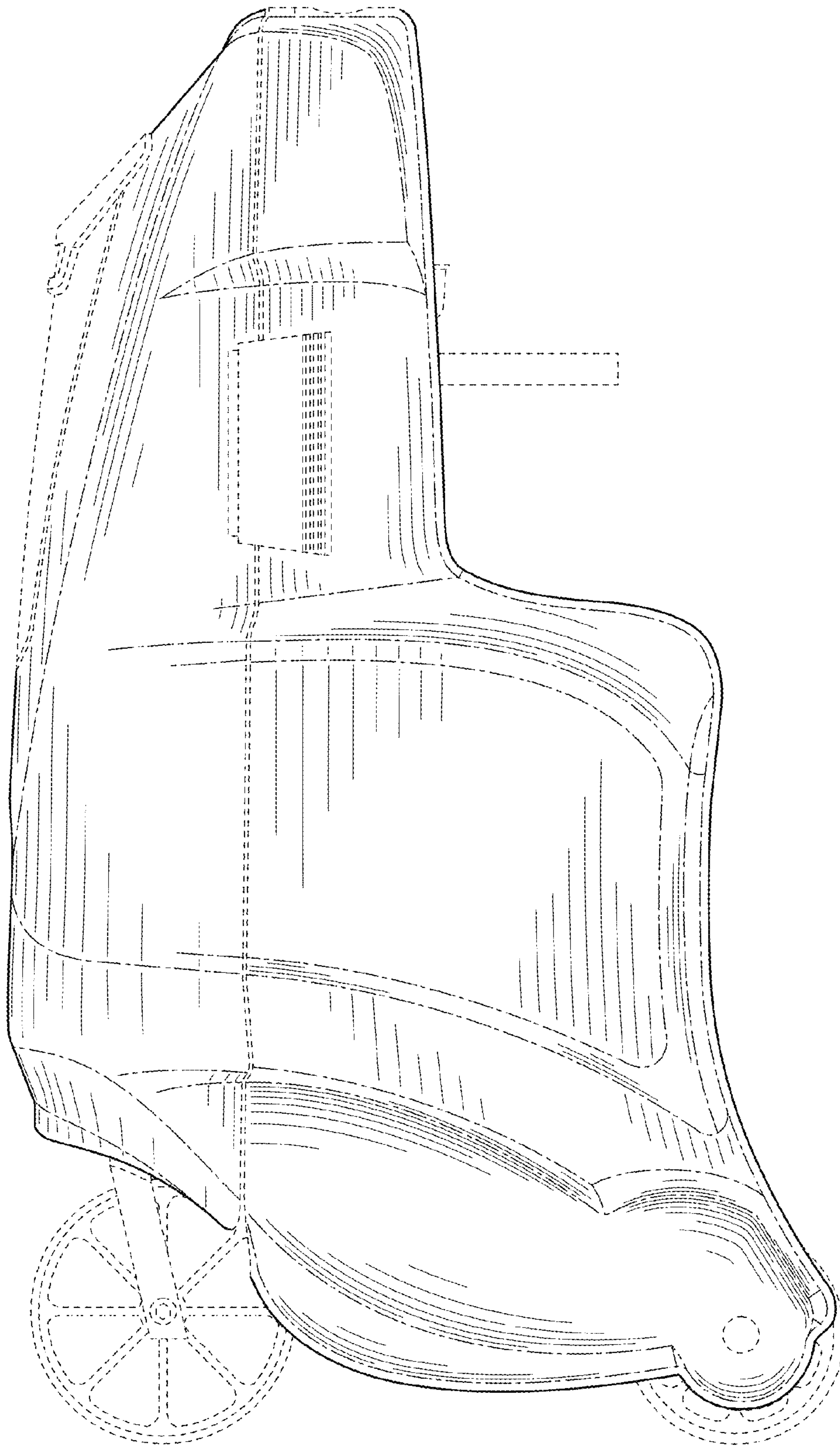

FIG. 5

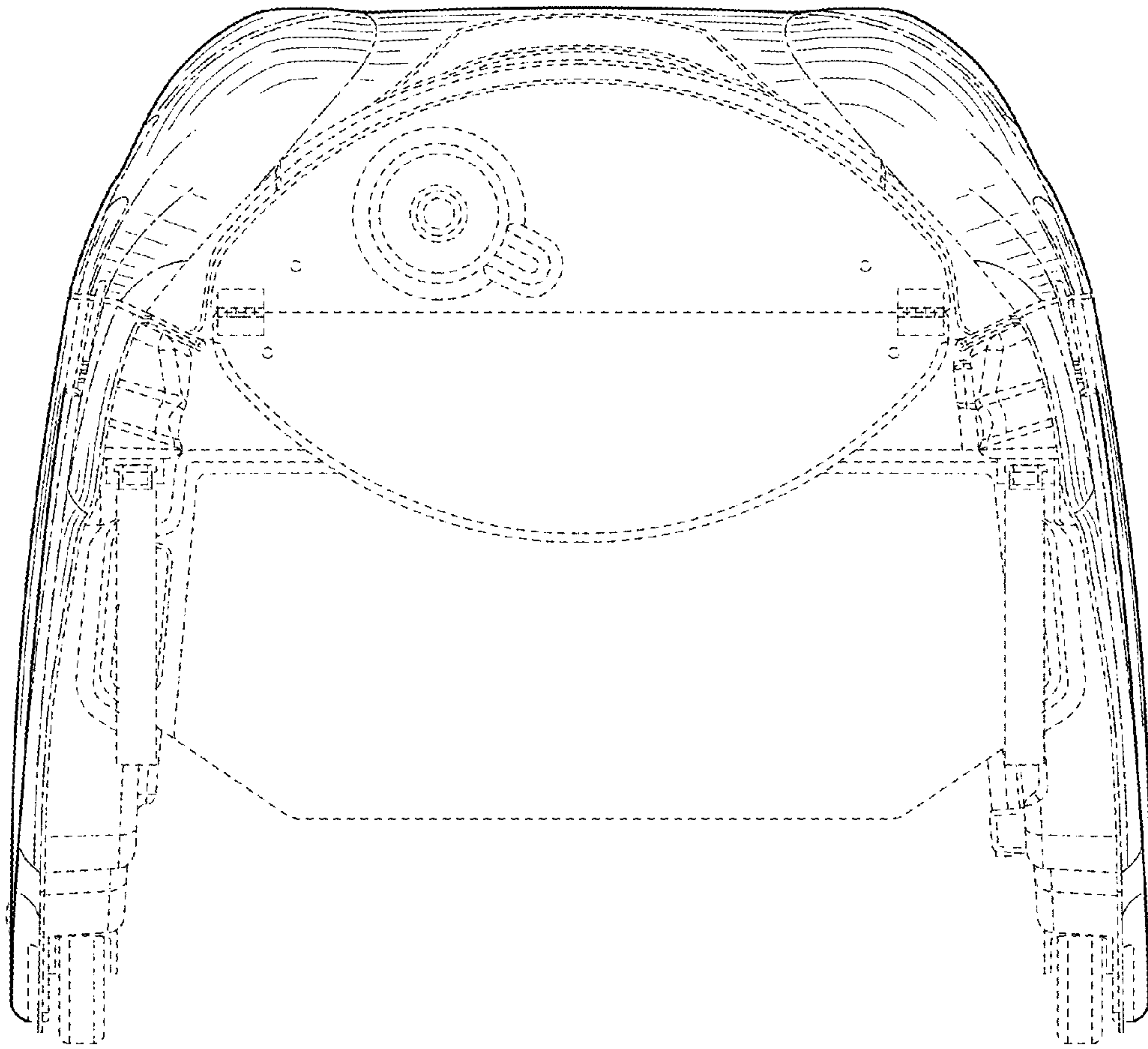

FIG. 6

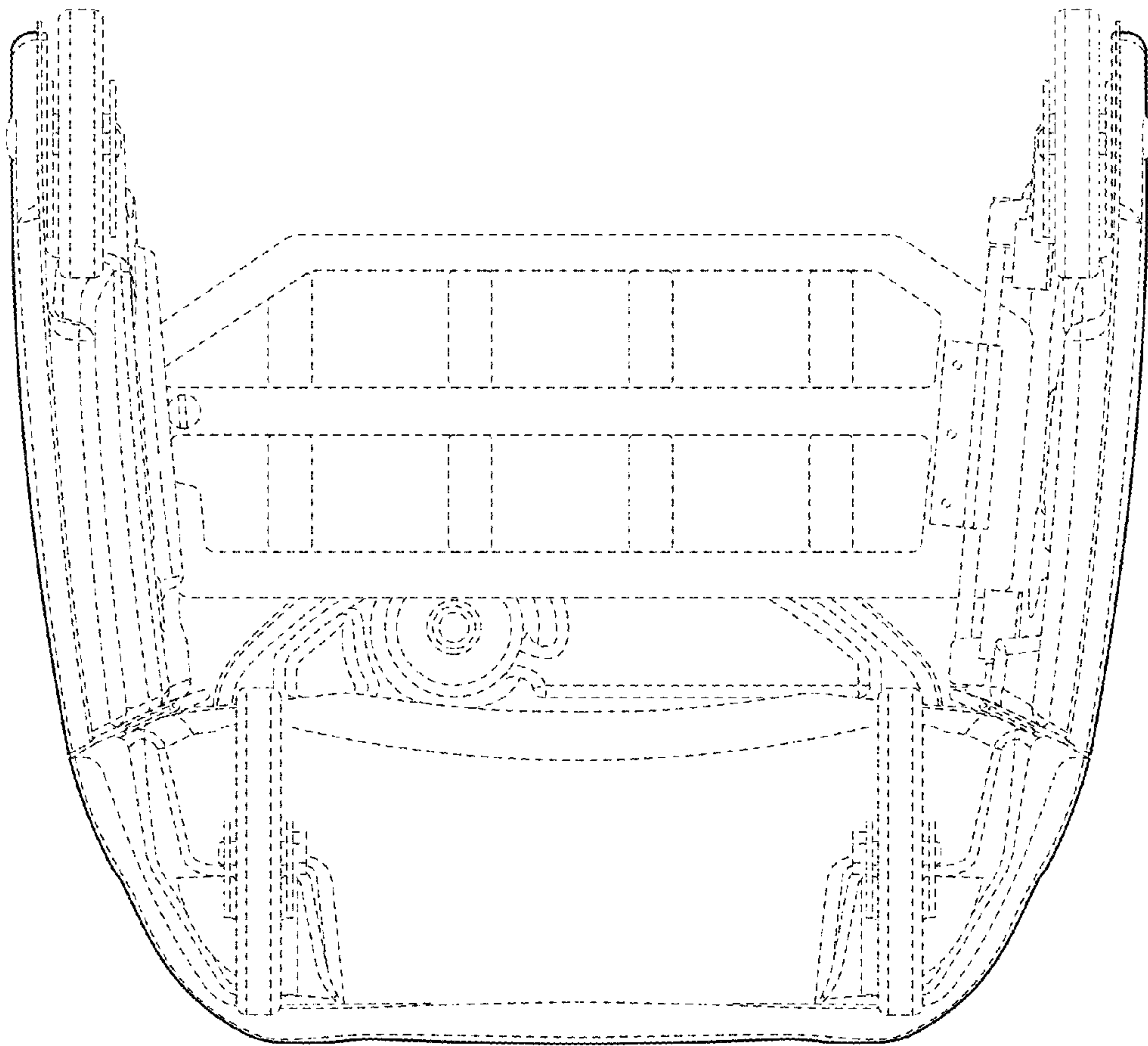

FIG. 7

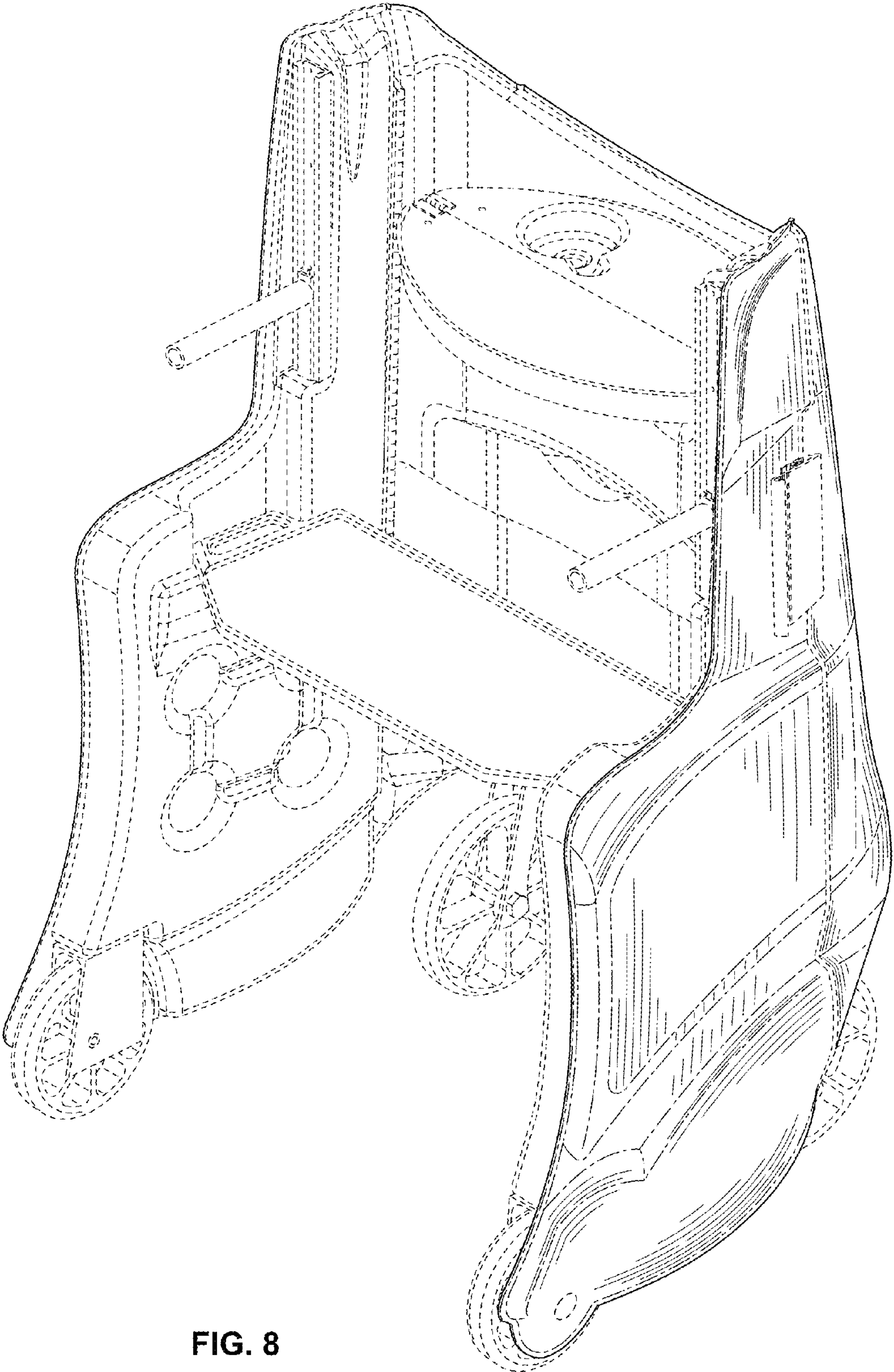

FIG. 8

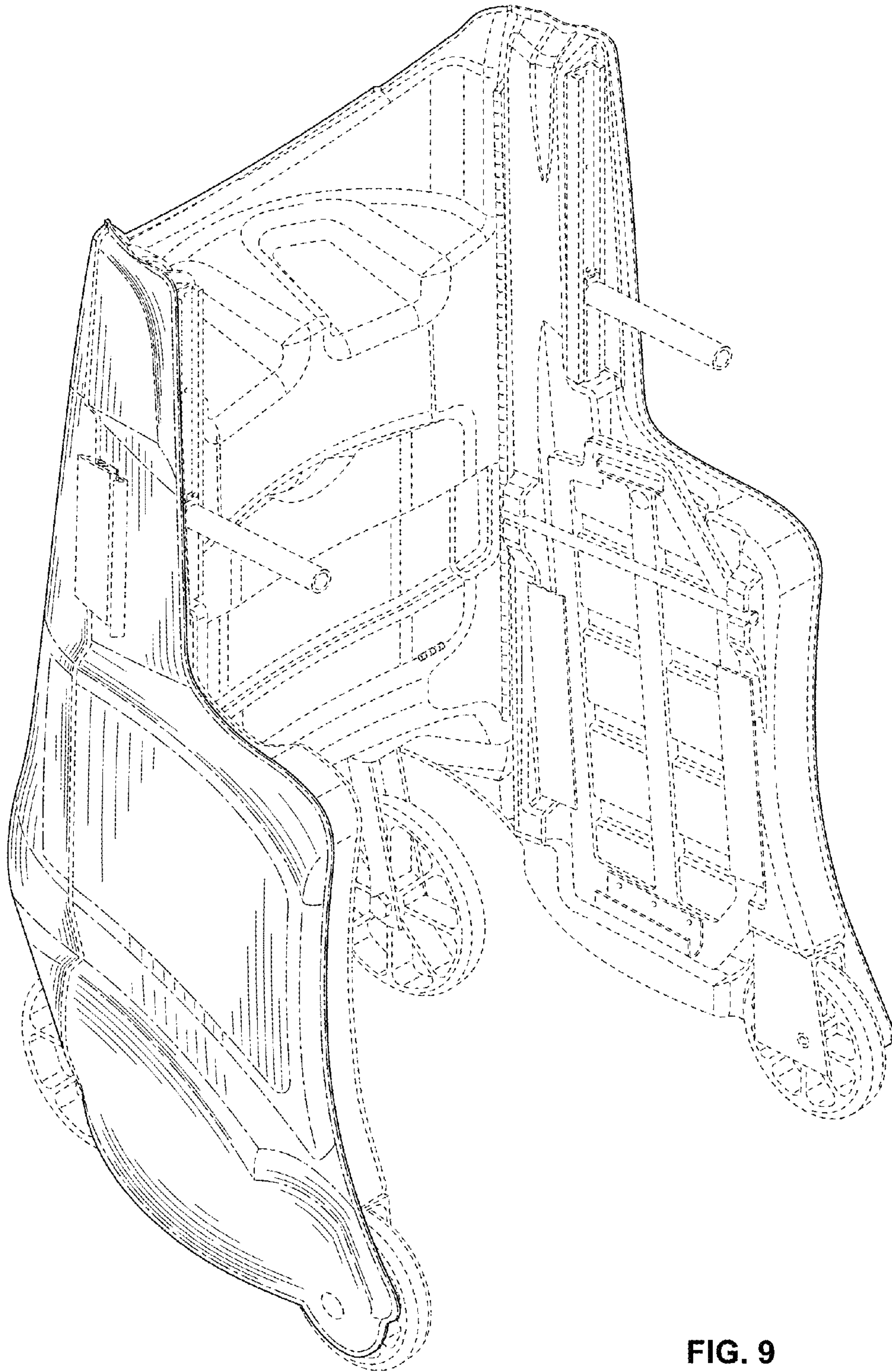

FIG. 9

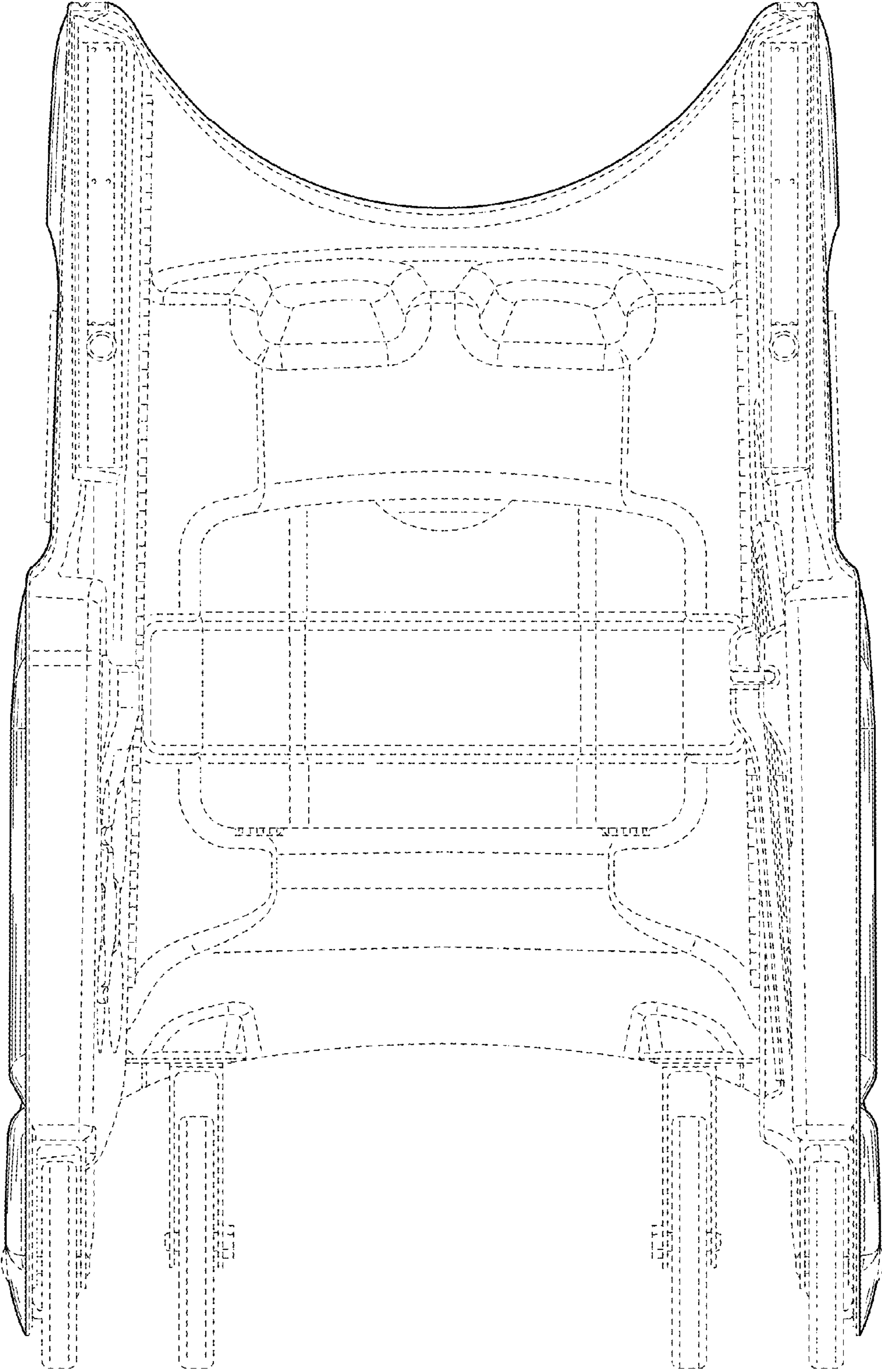

FIG. 10

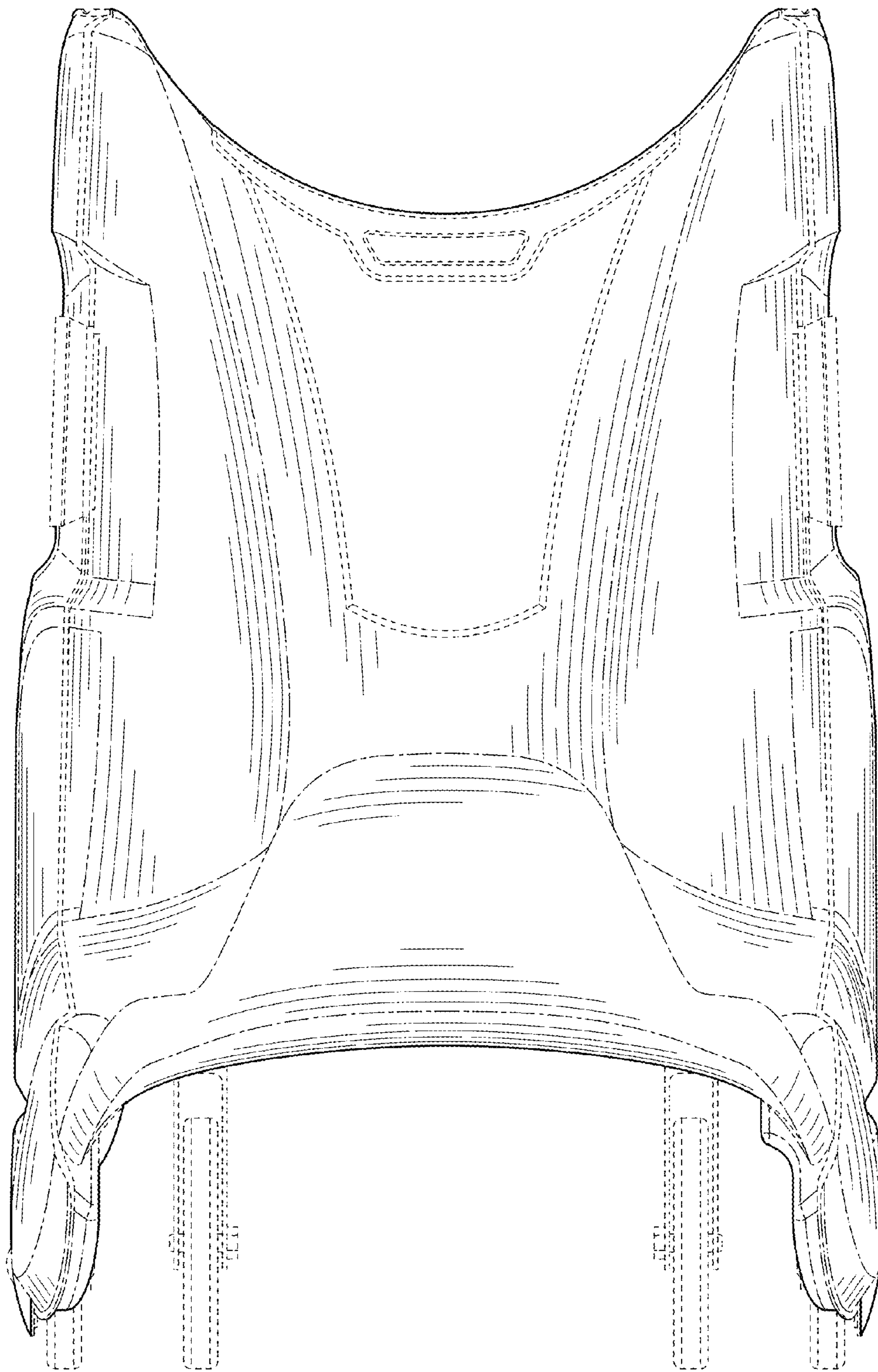

FIG. 11

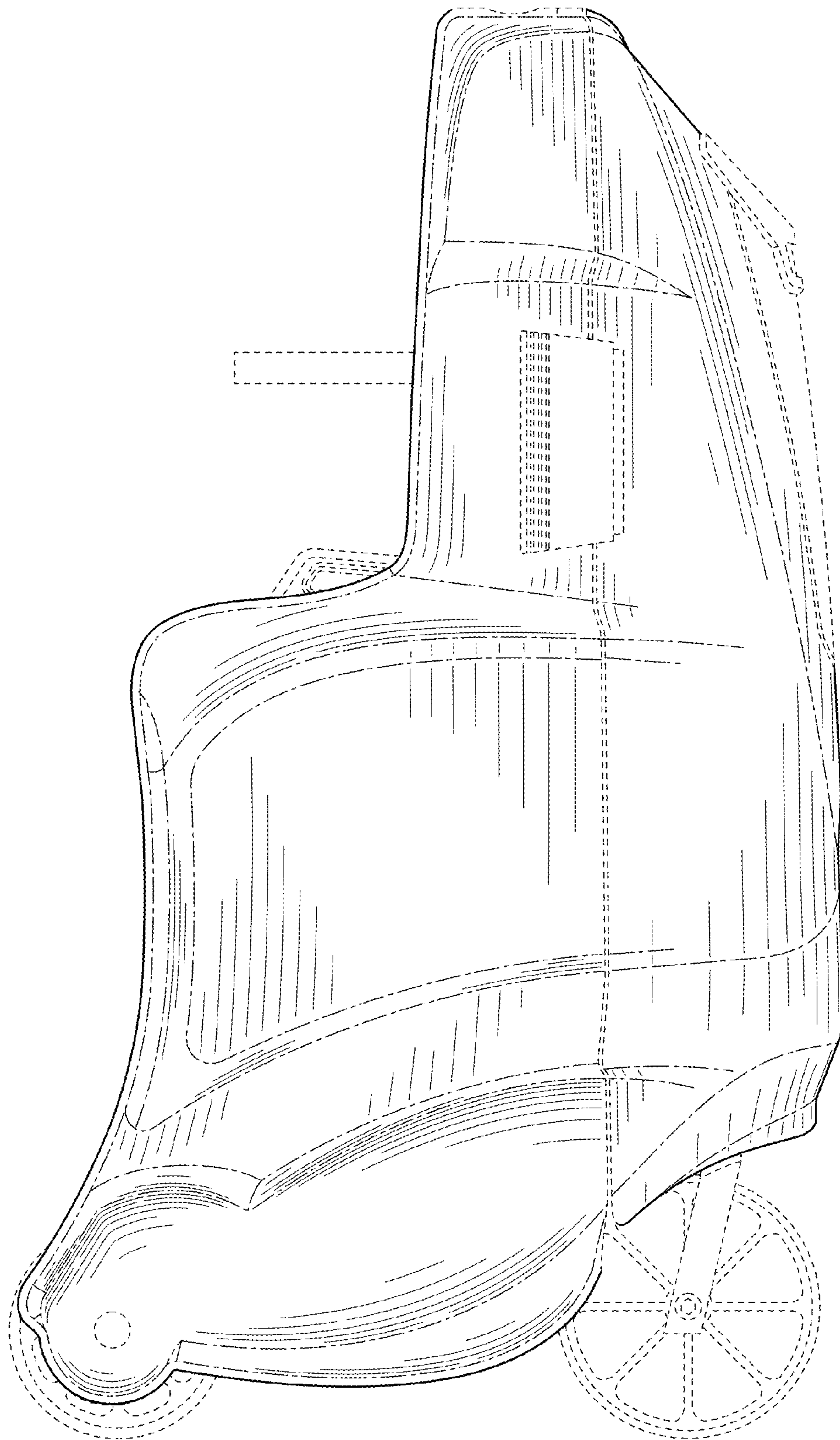

FIG. 12

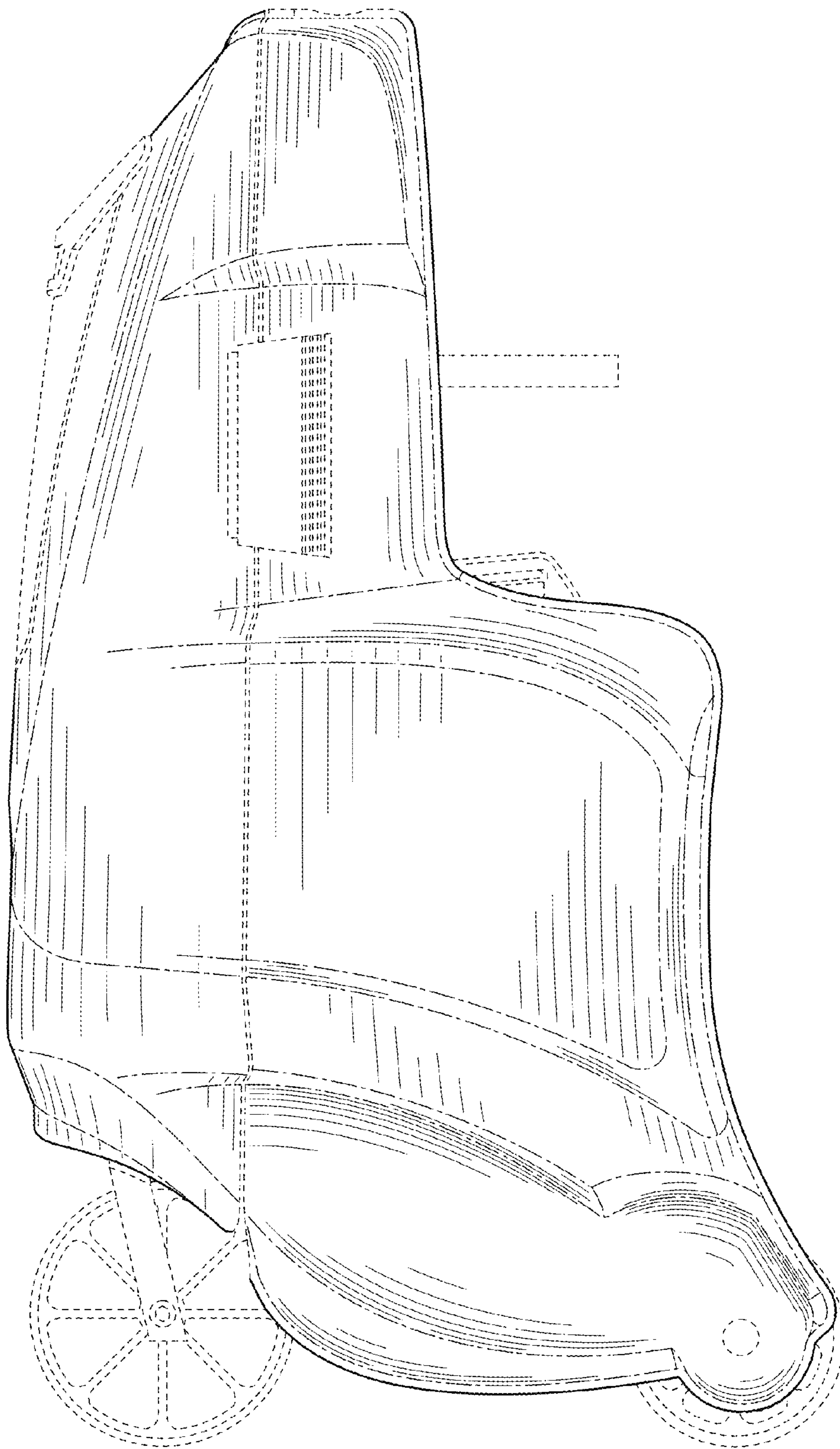

FIG. 13

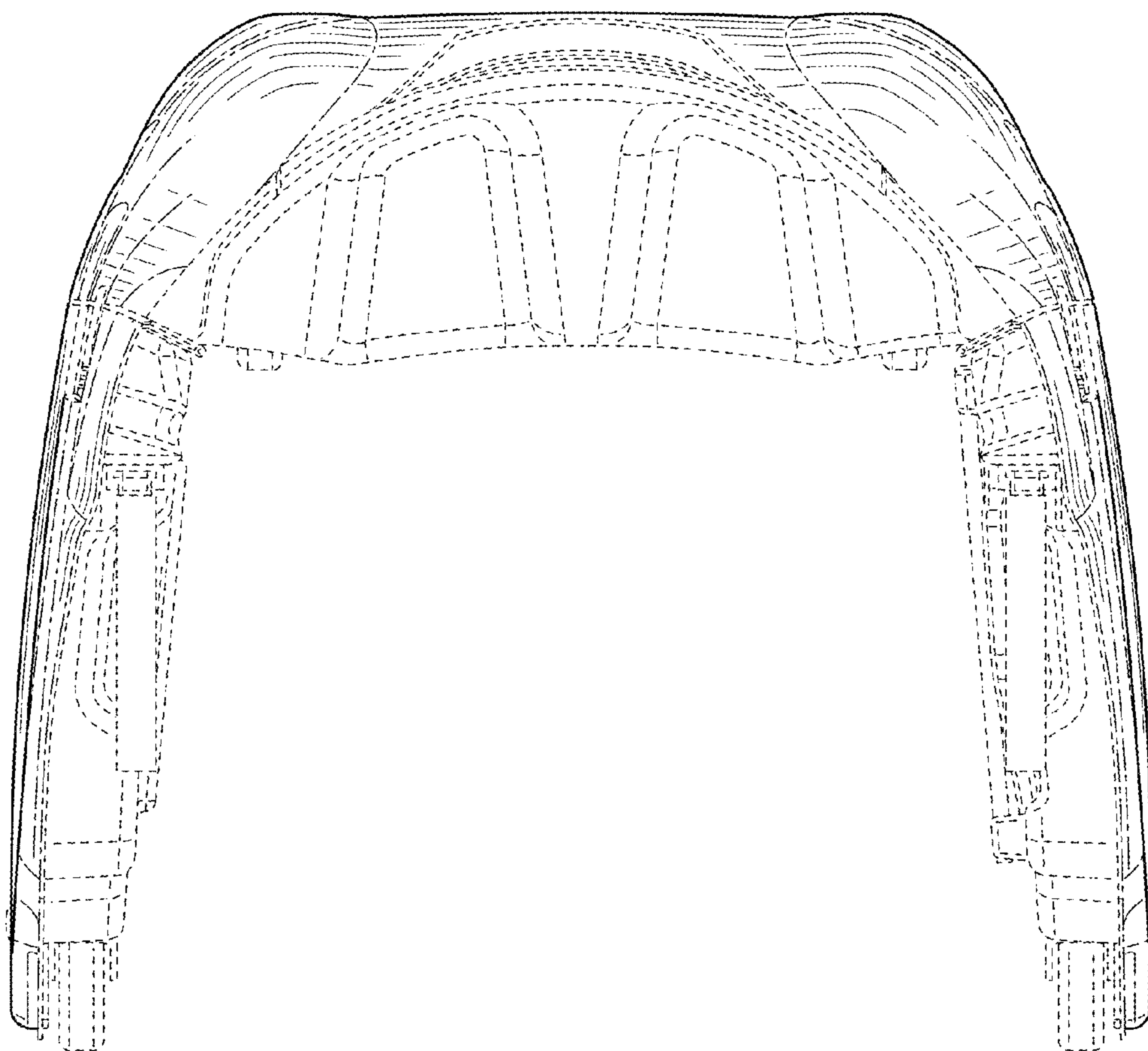

FIG. 14

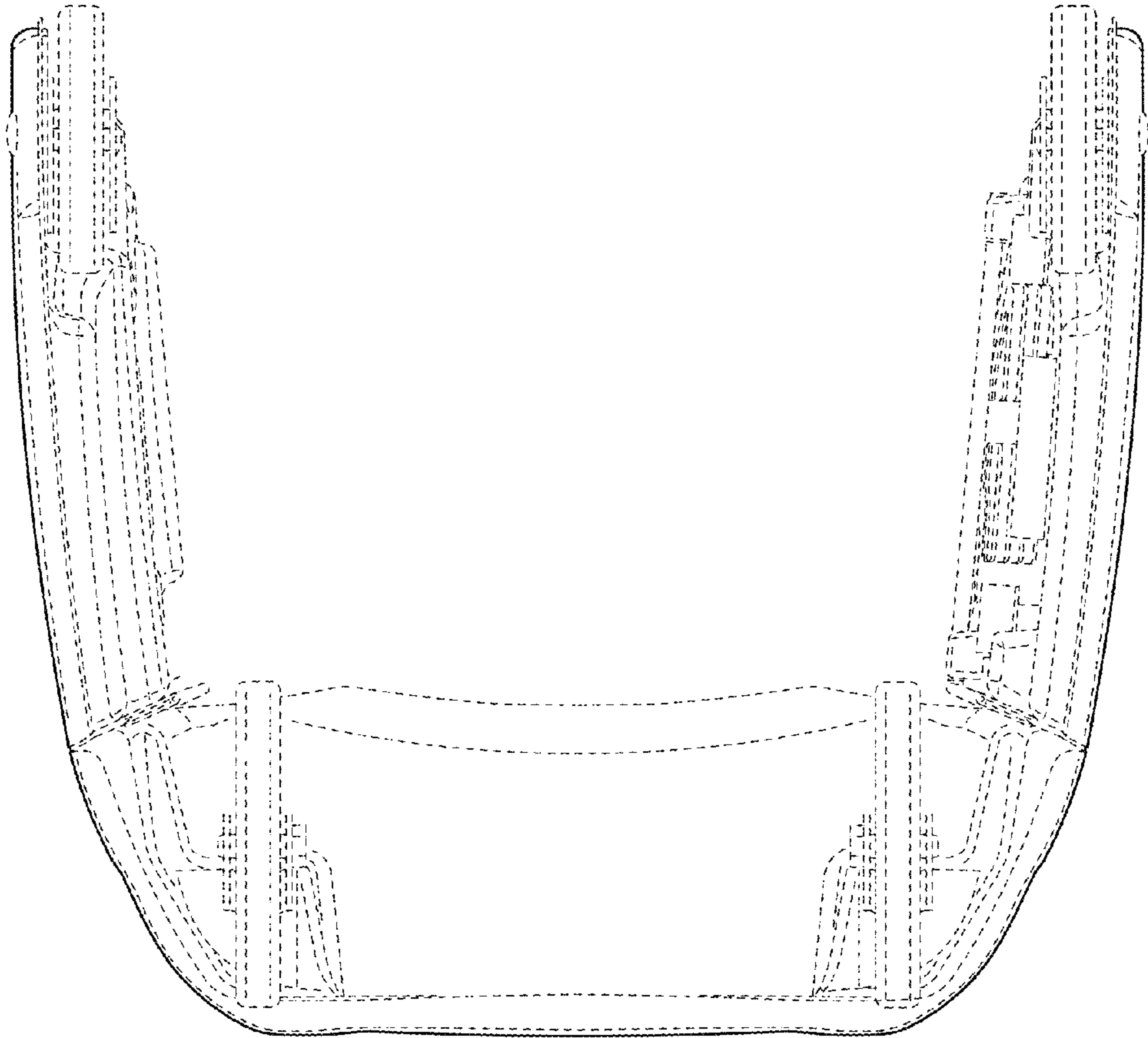

FIG. 15

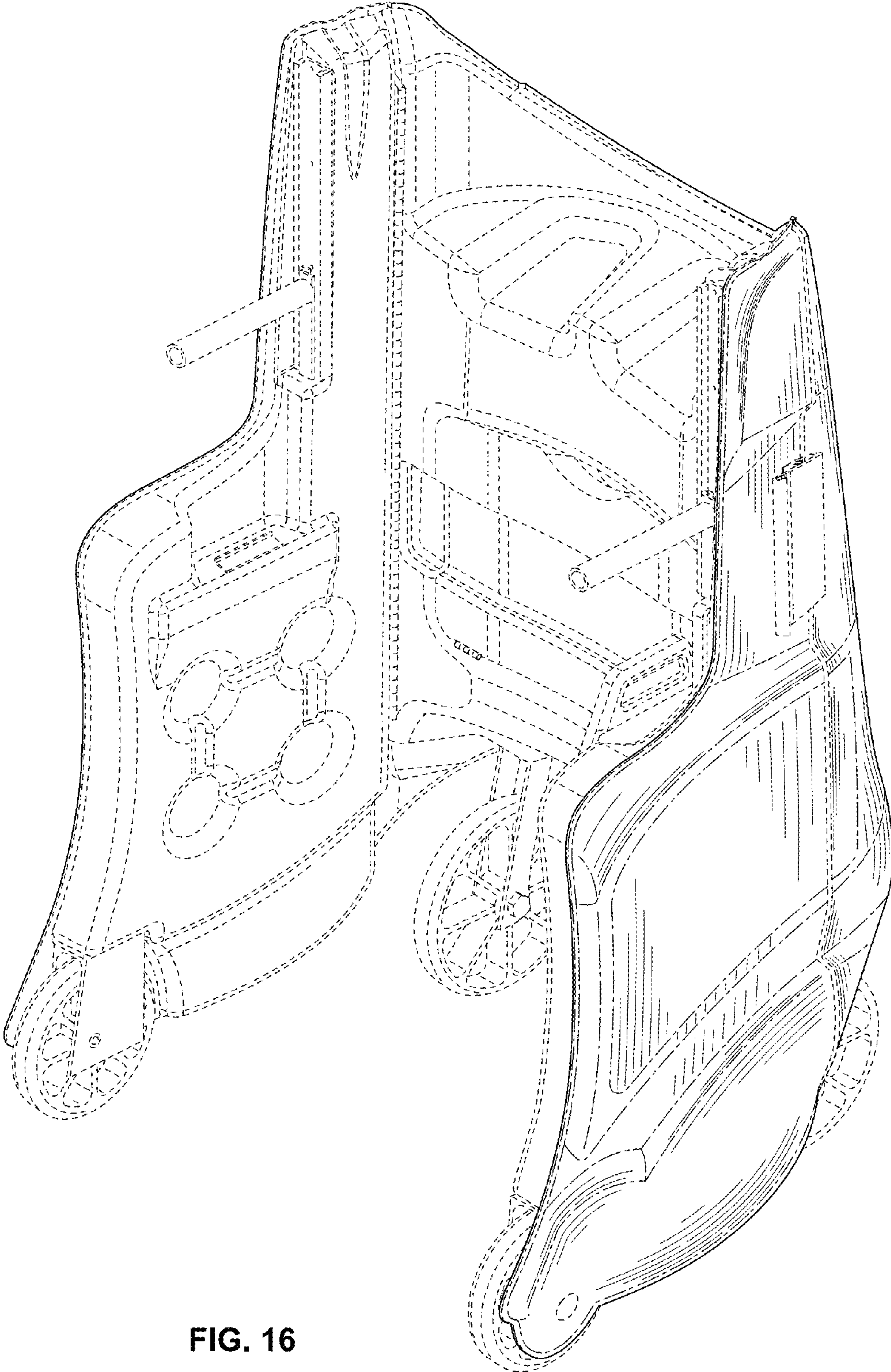

FIG. 16

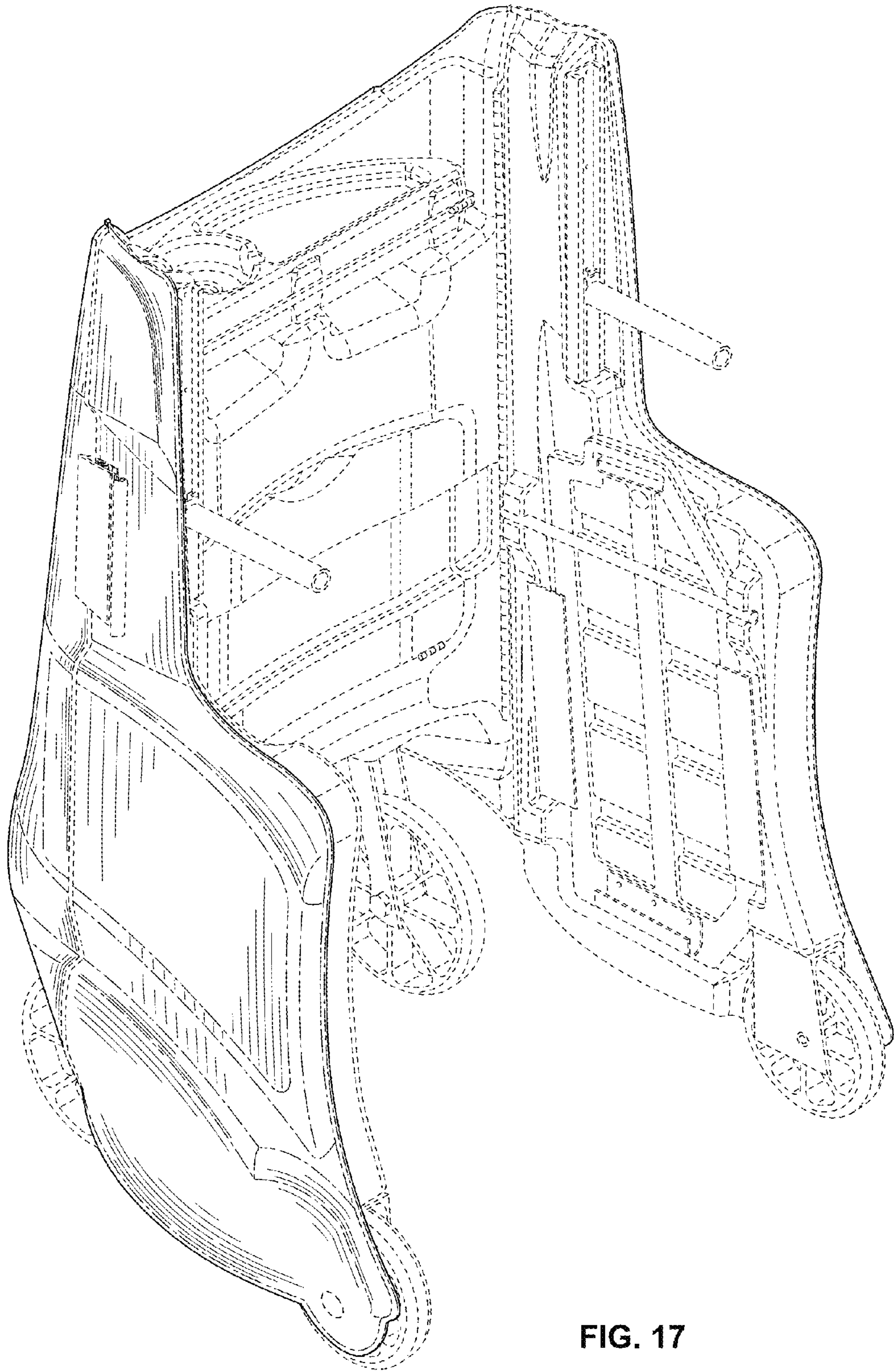

FIG. 17

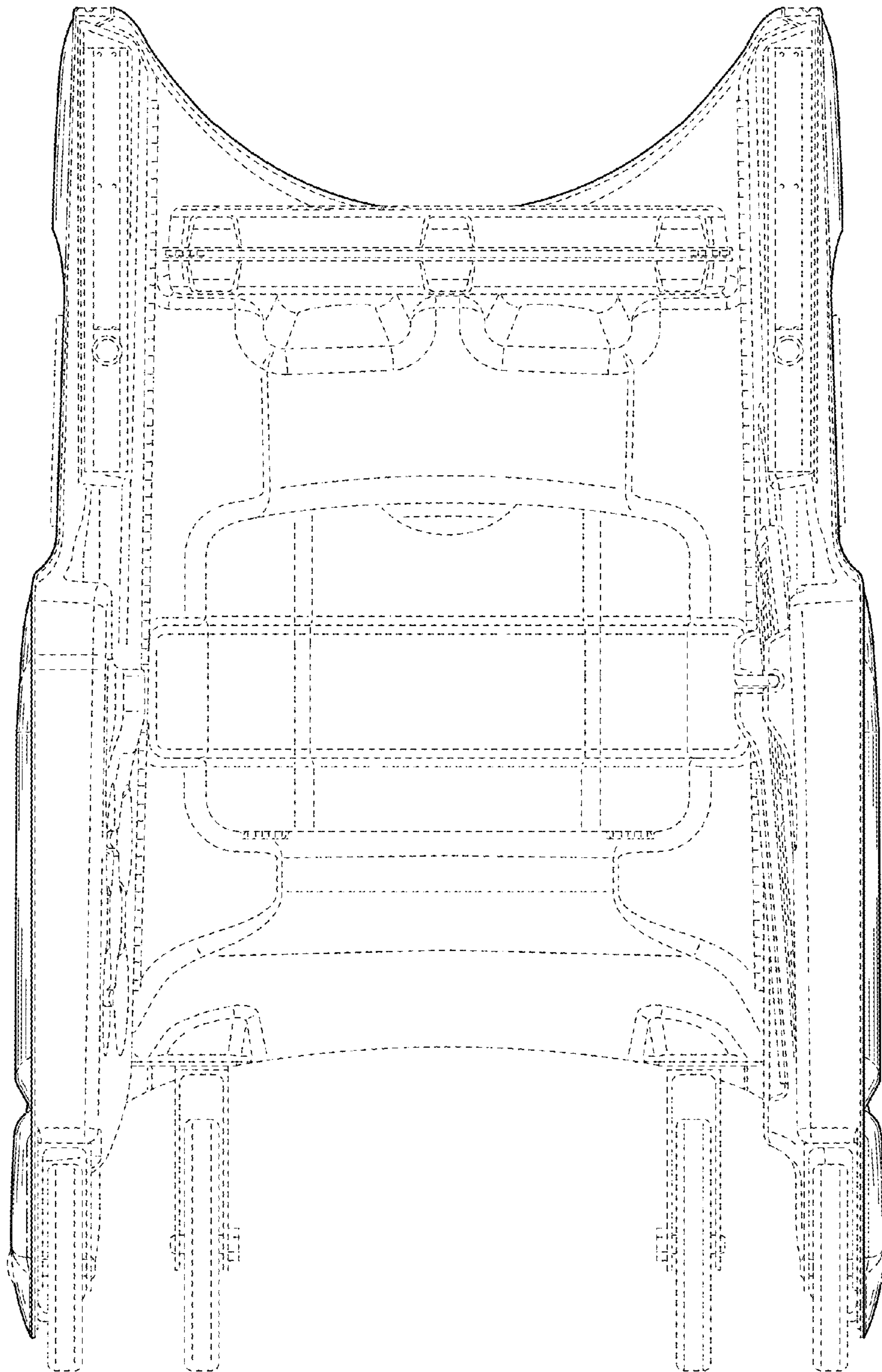

FIG. 18

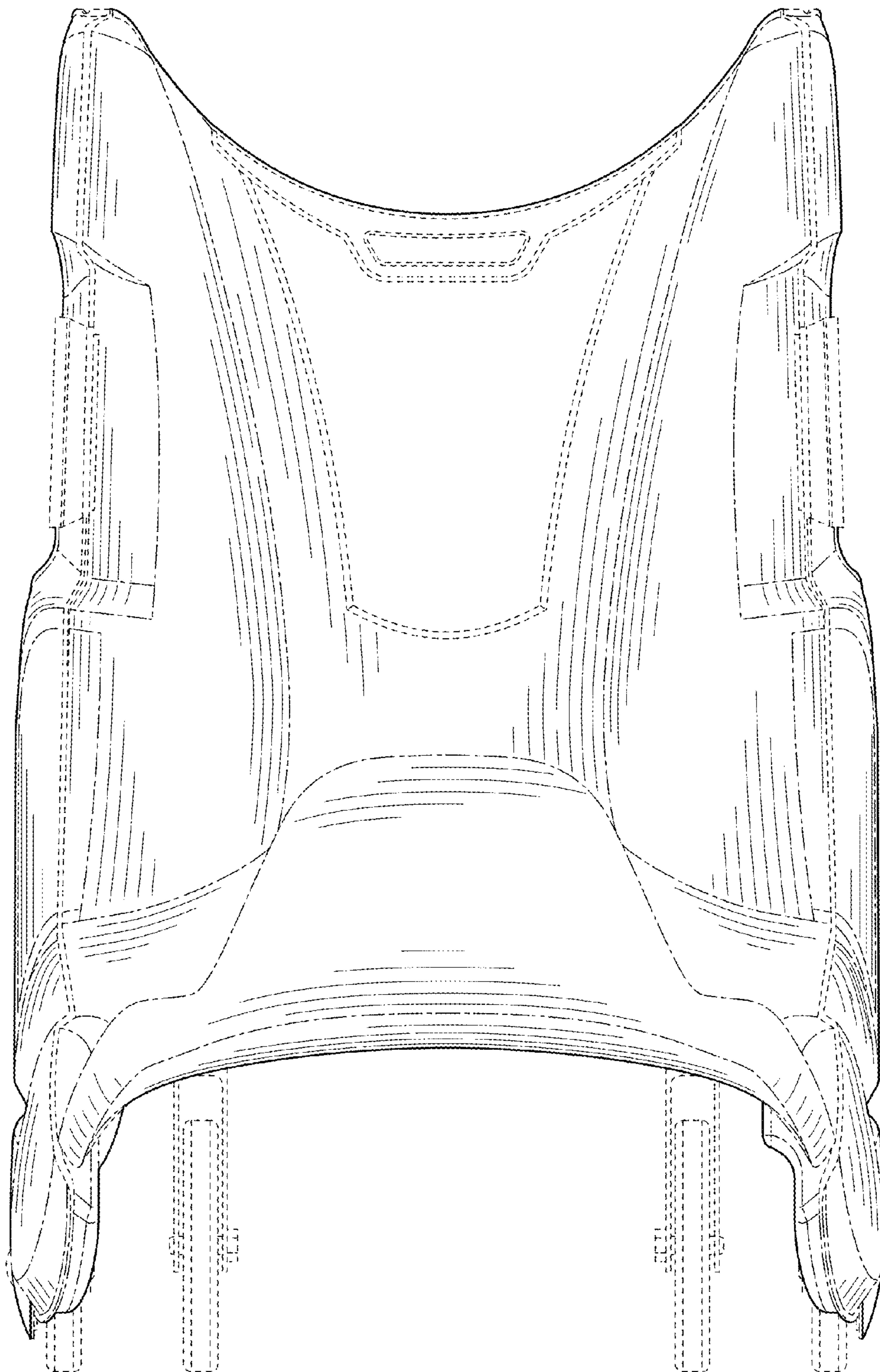

FIG. 19

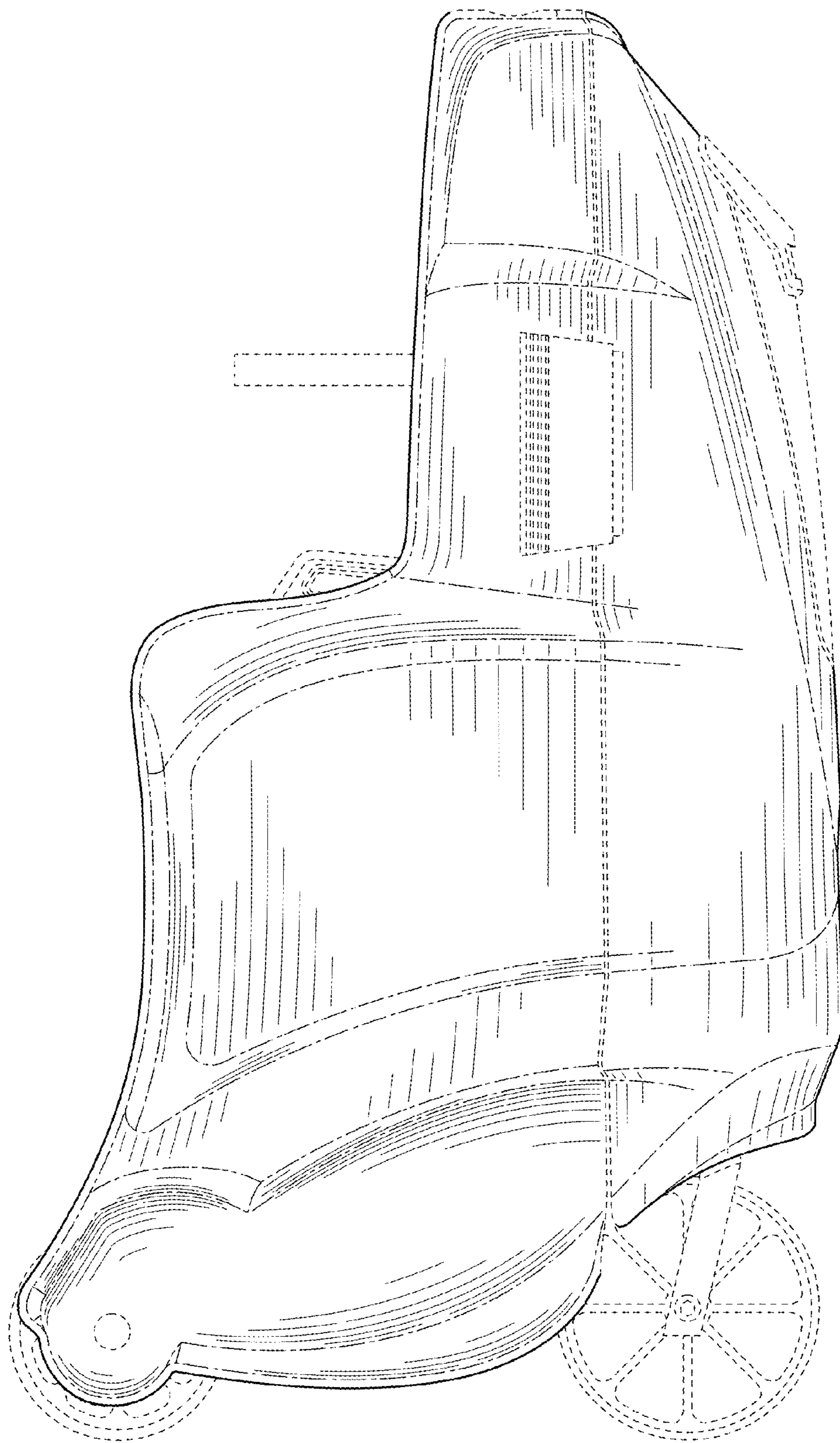

FIG. 20

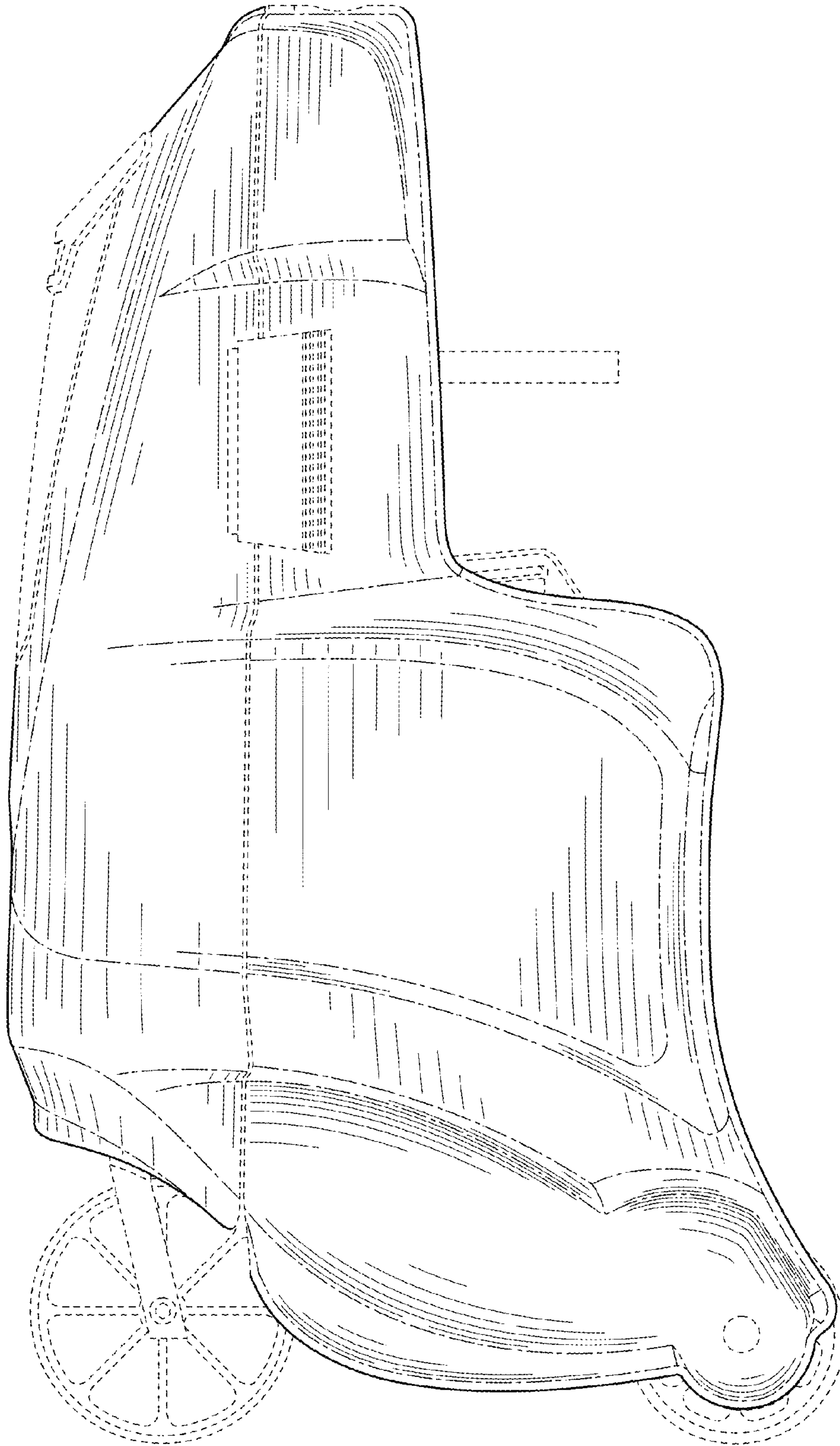

FIG. 21

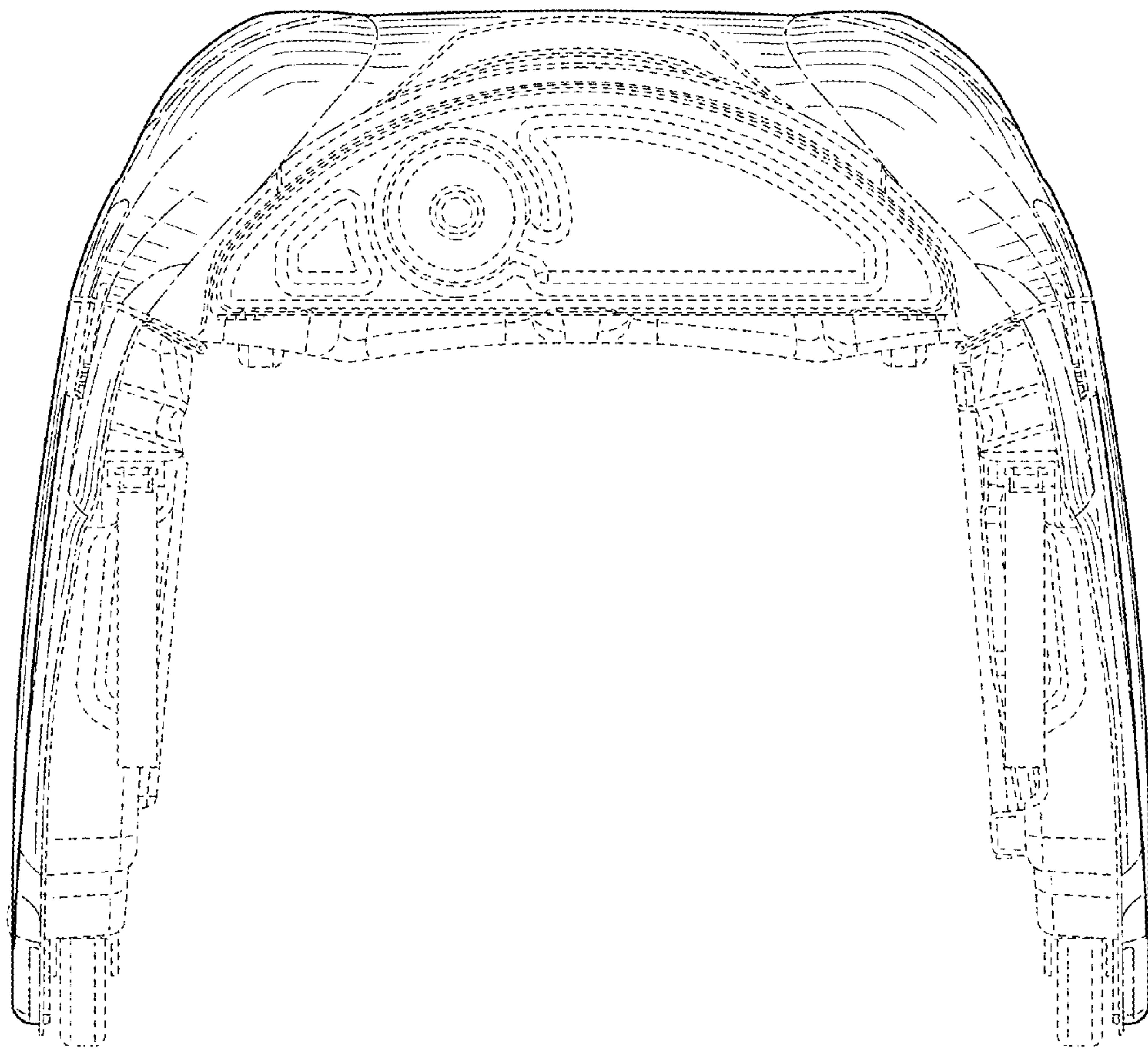

FIG. 22

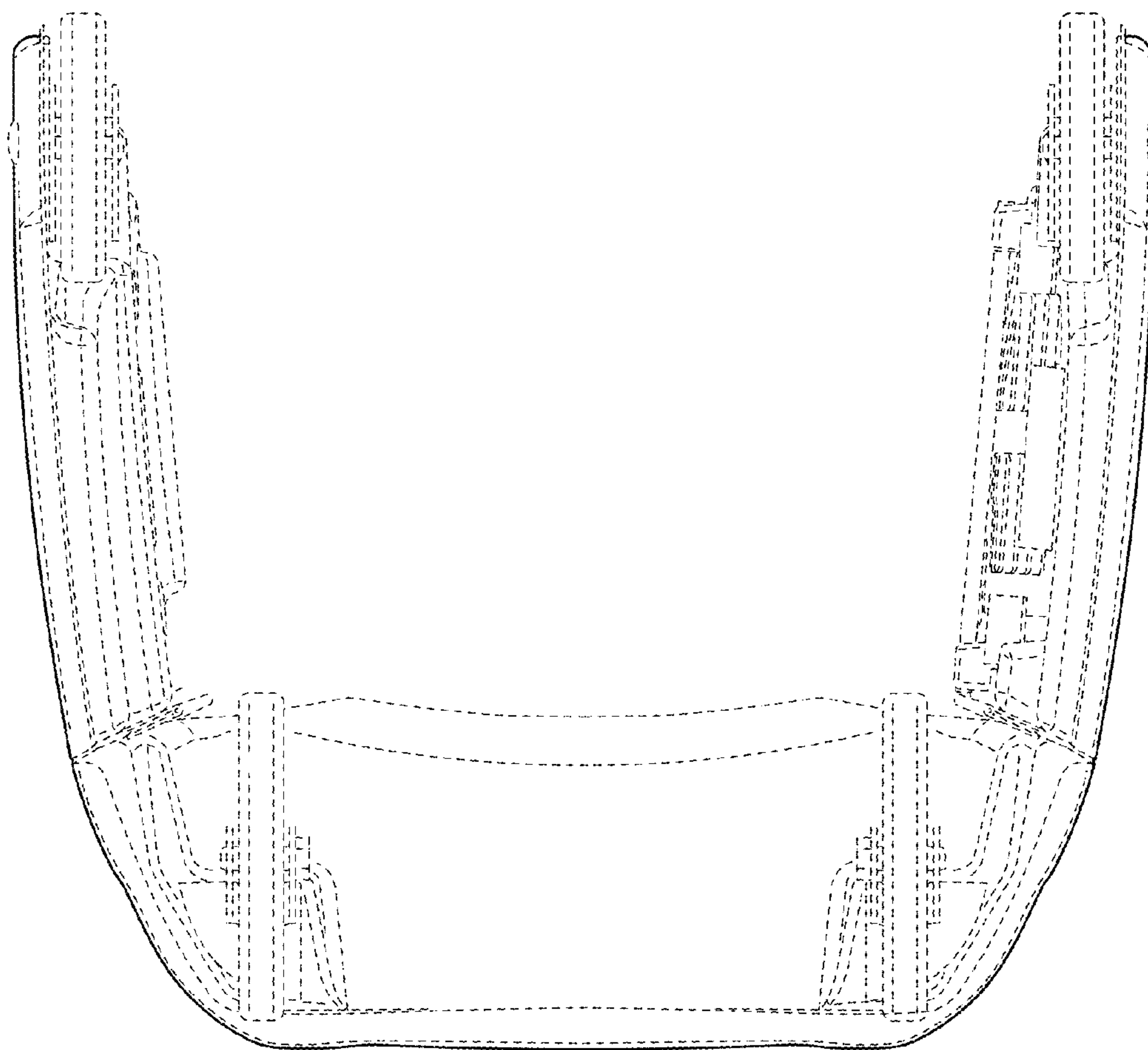

FIG. 23

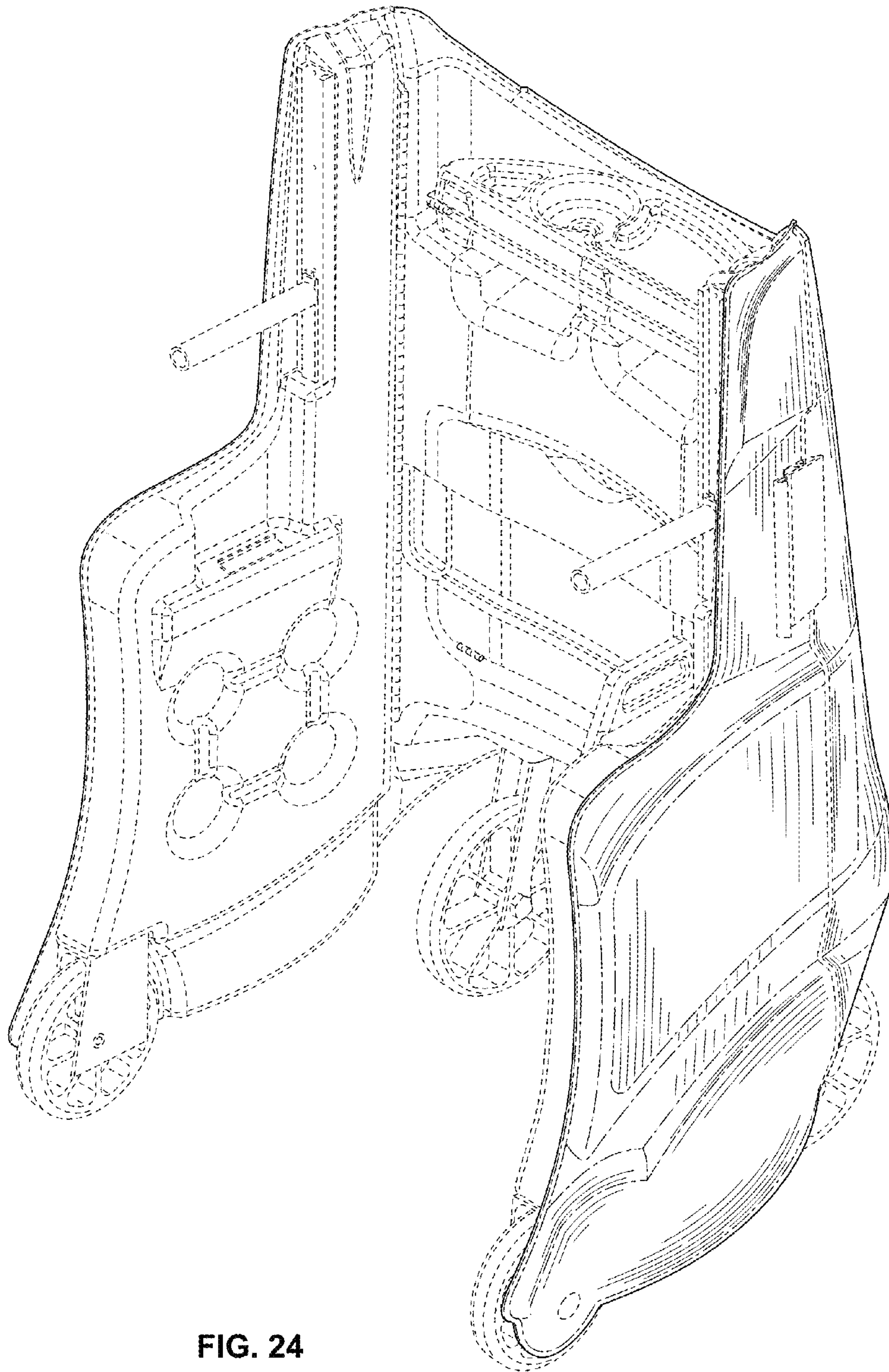

FIG. 24

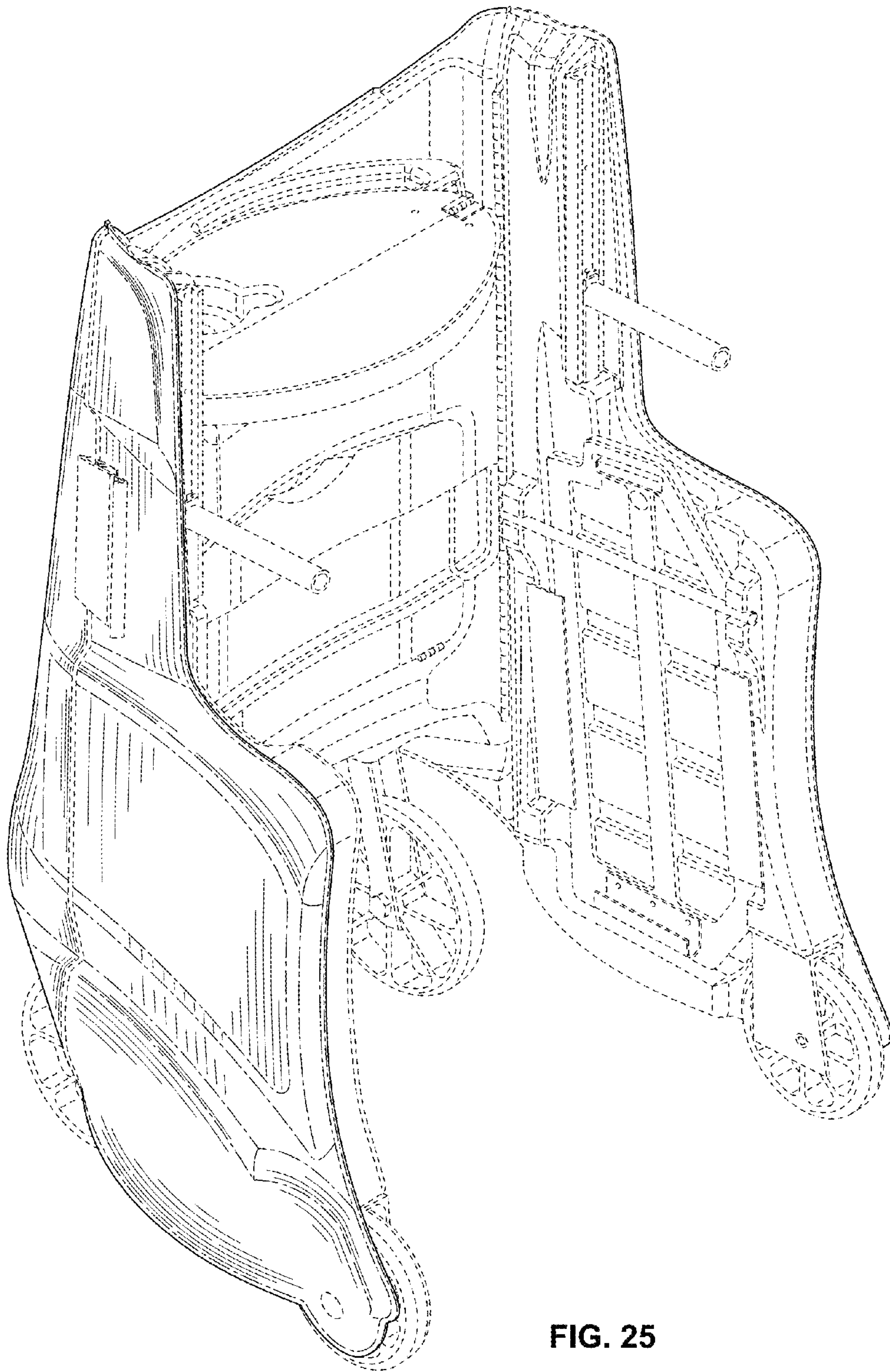

FIG. 25

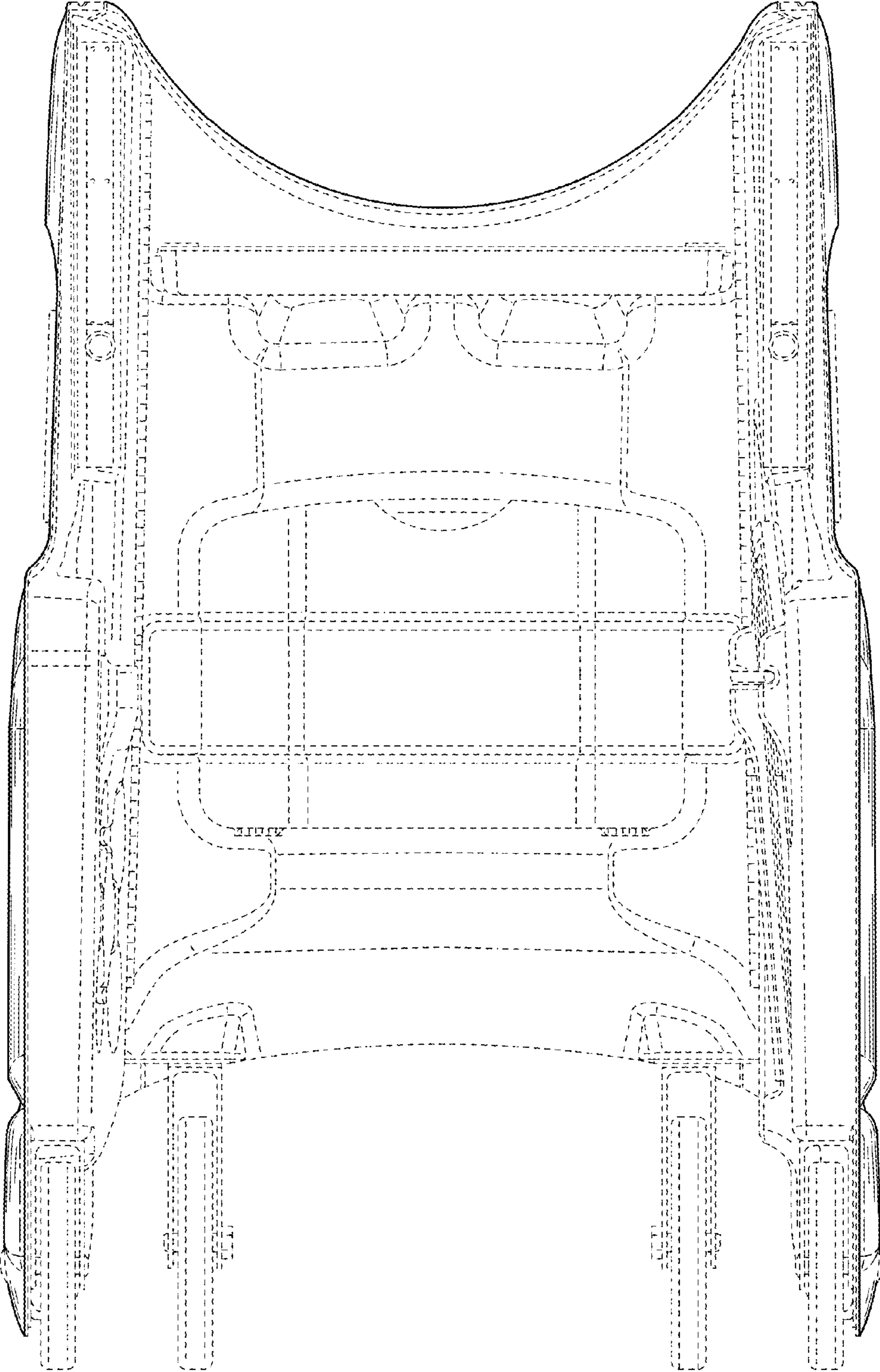

FIG. 26

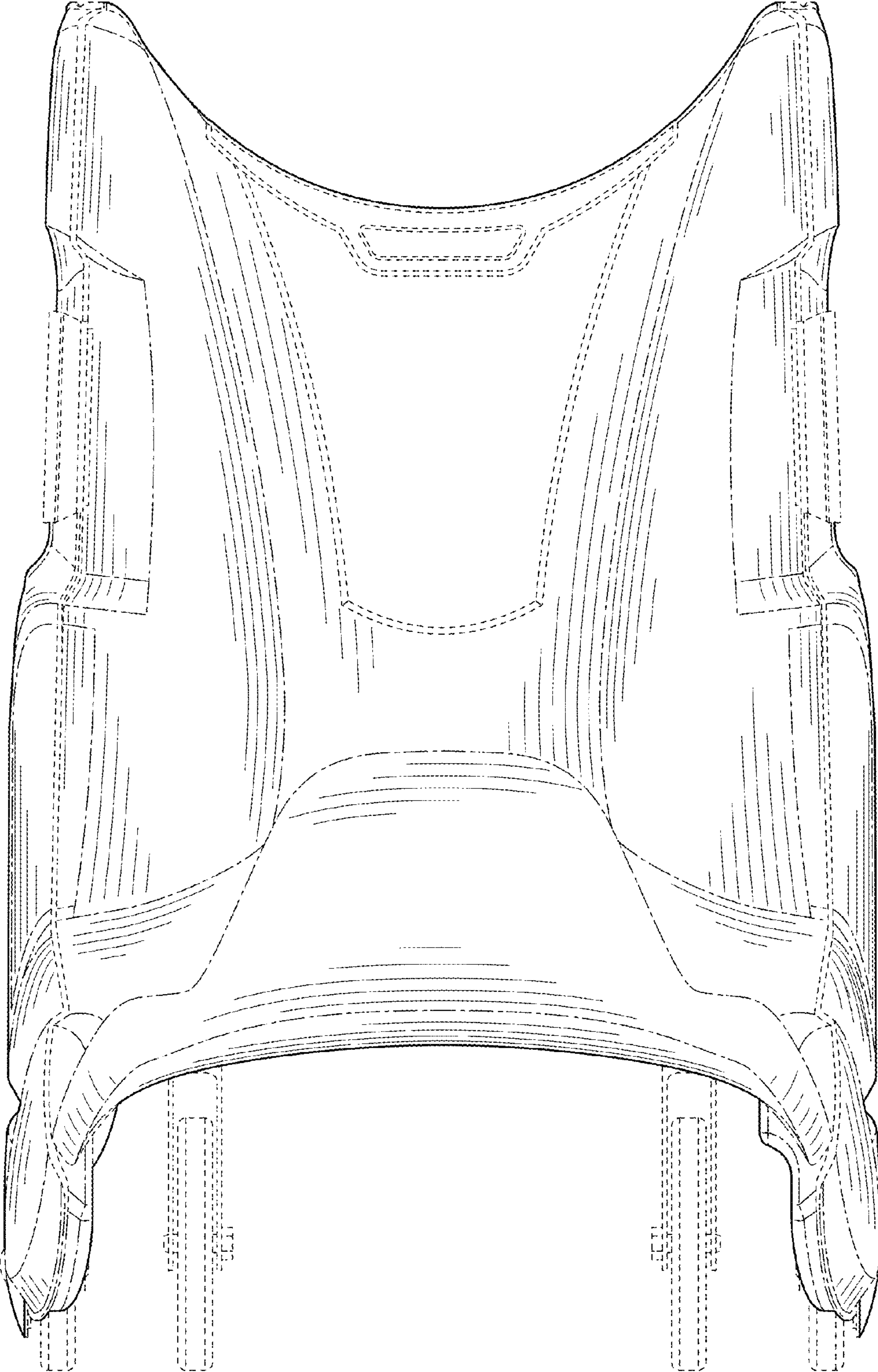

FIG. 27

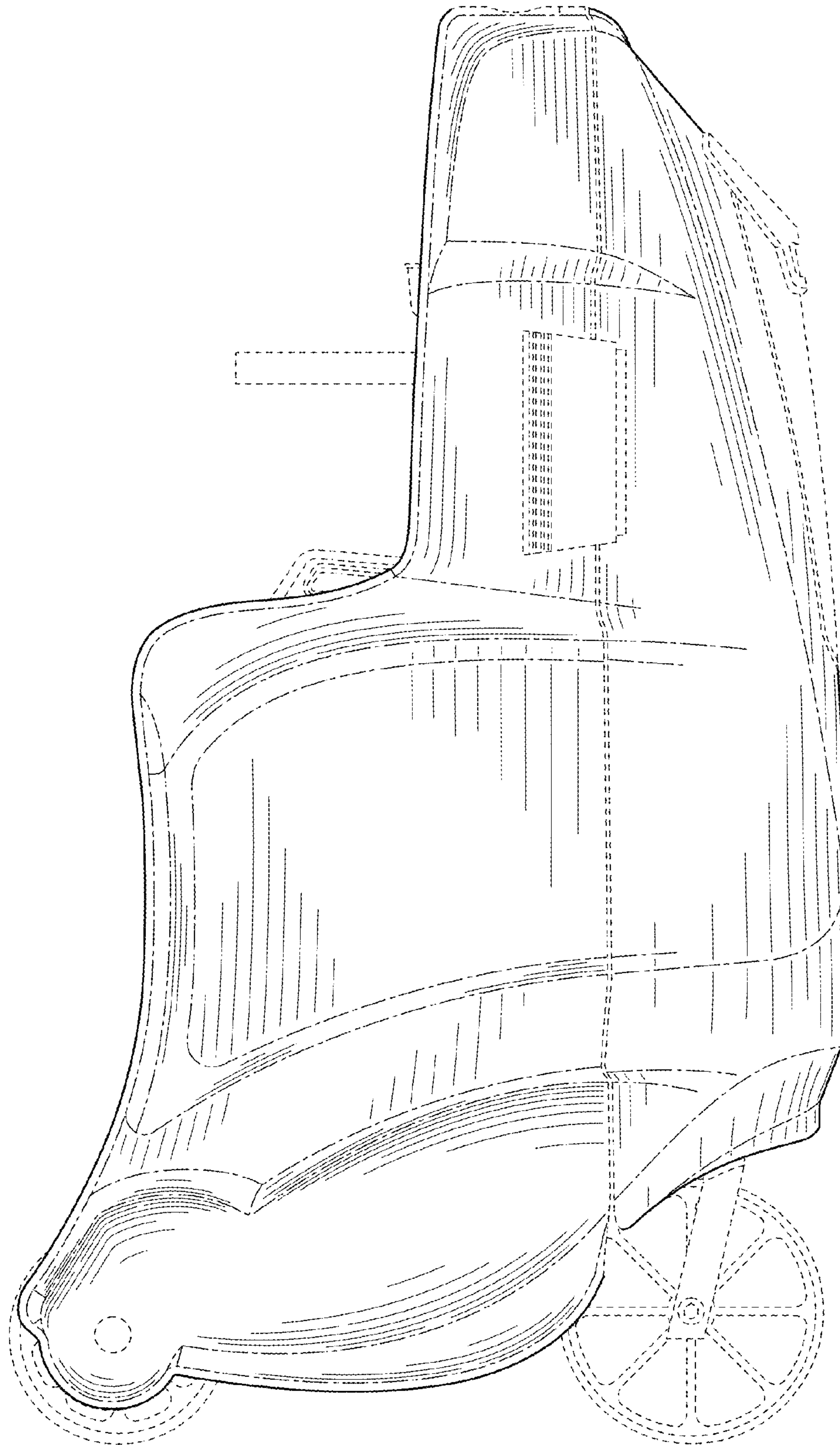

FIG. 28

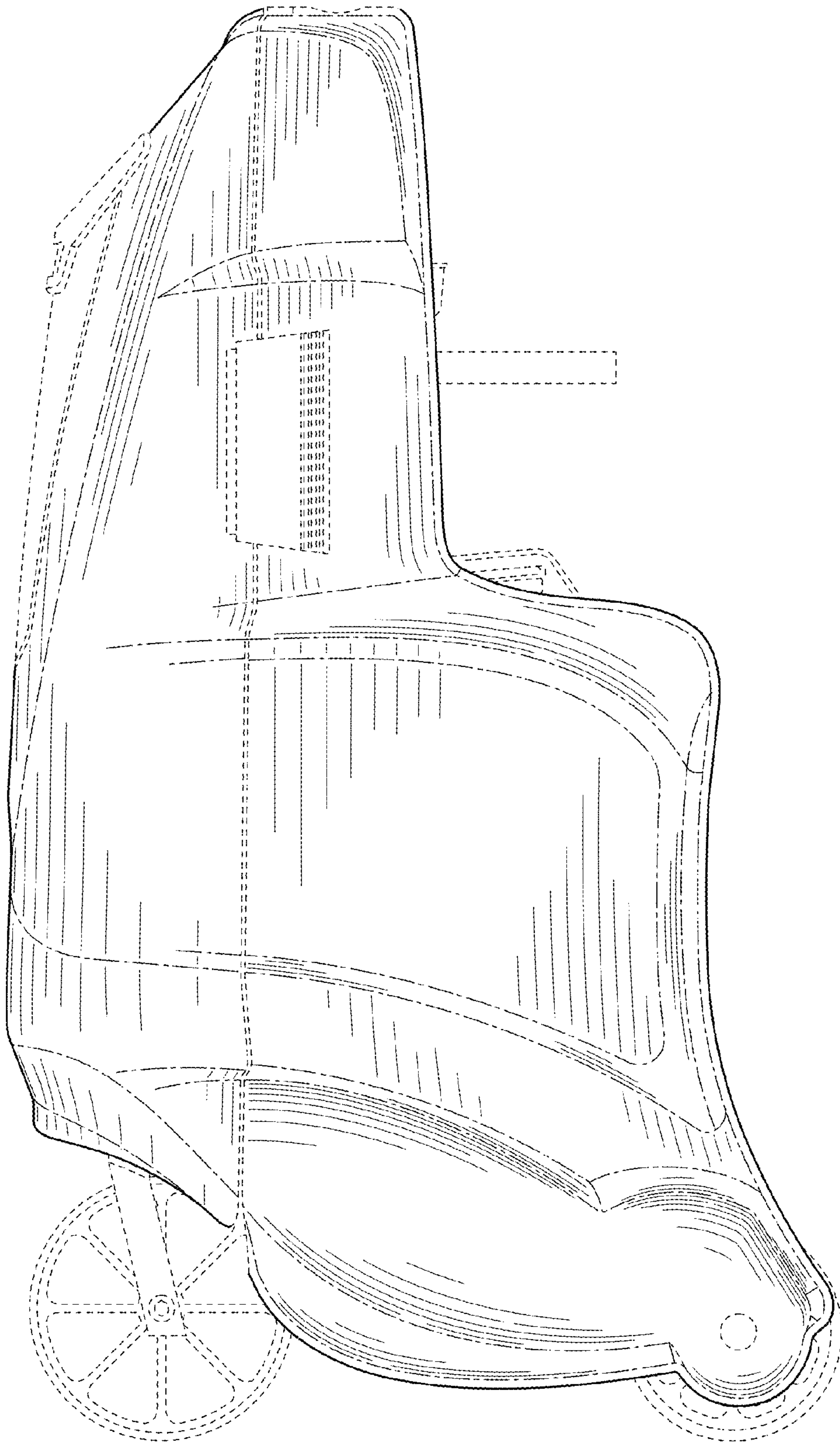

FIG. 29

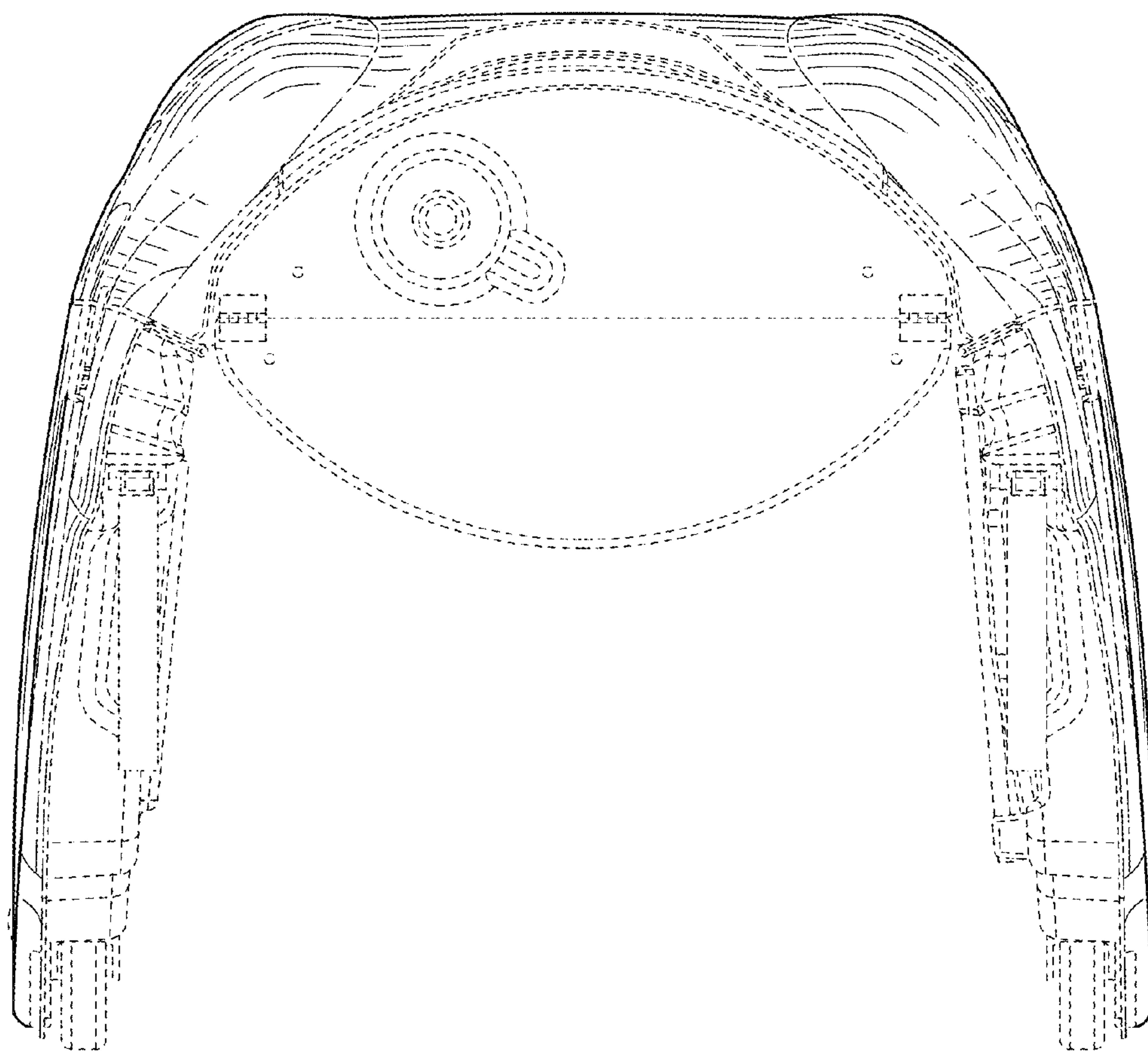

FIG. 30



FIG. 31

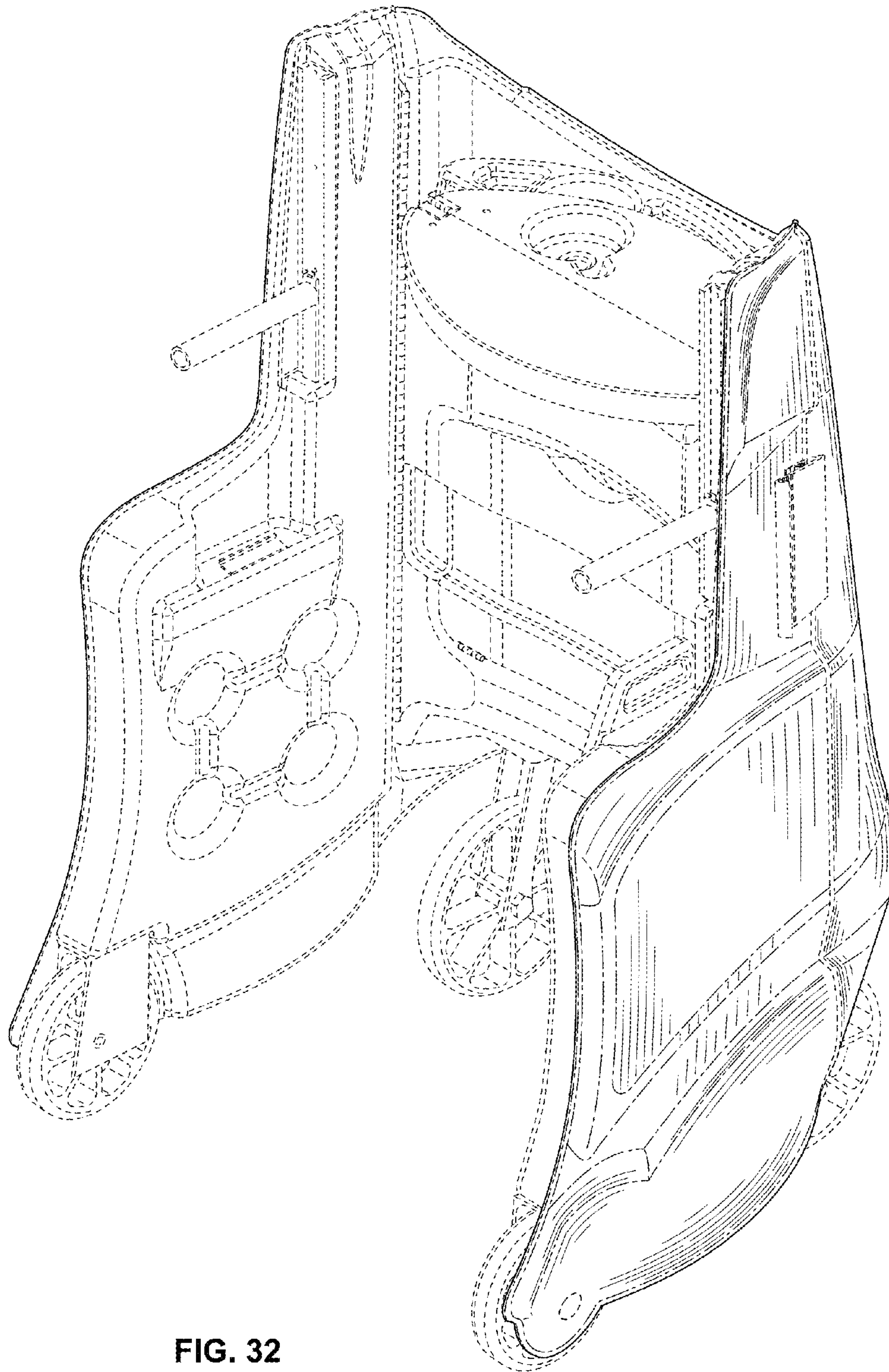

FIG. 32

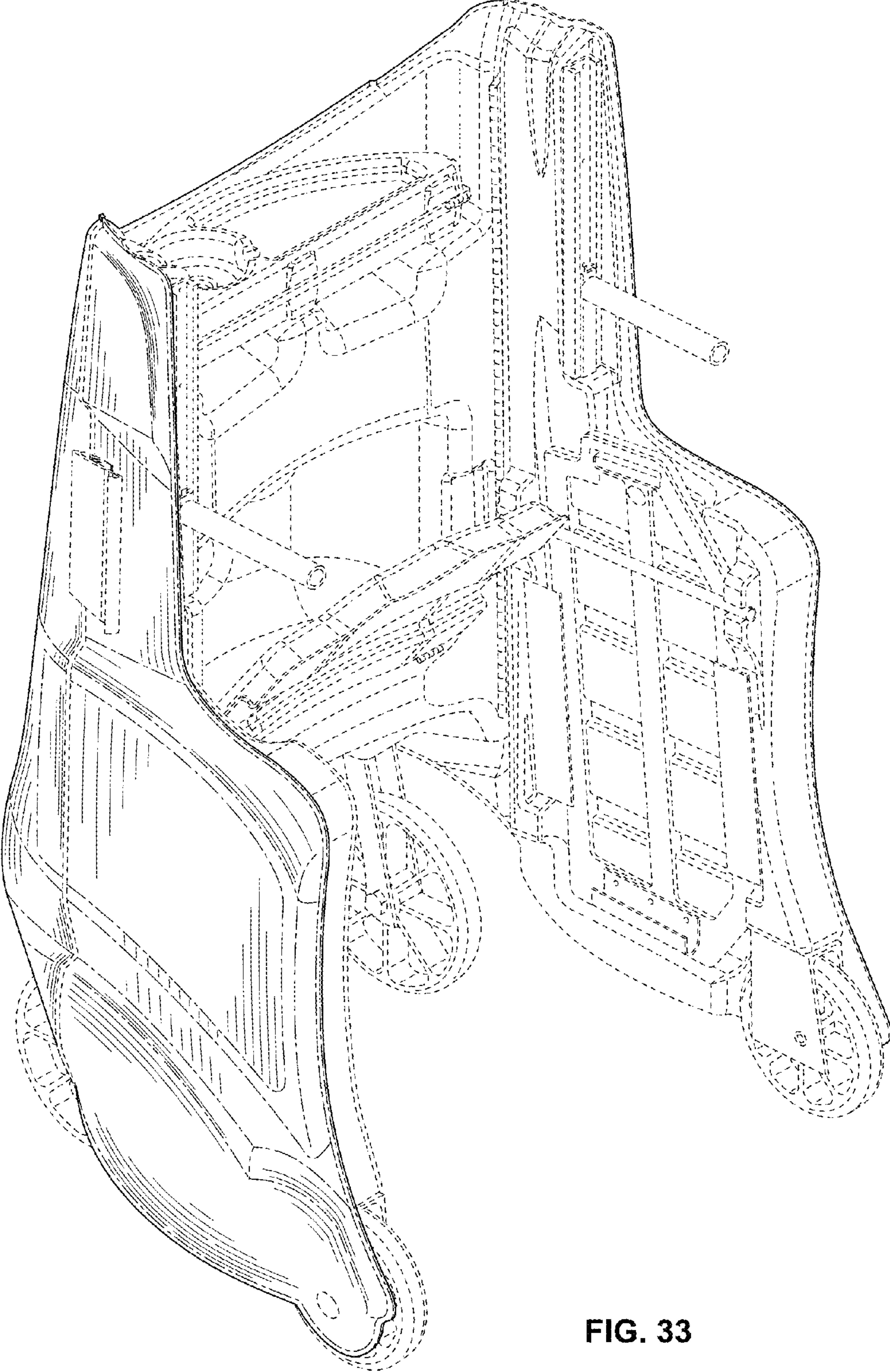

FIG. 33

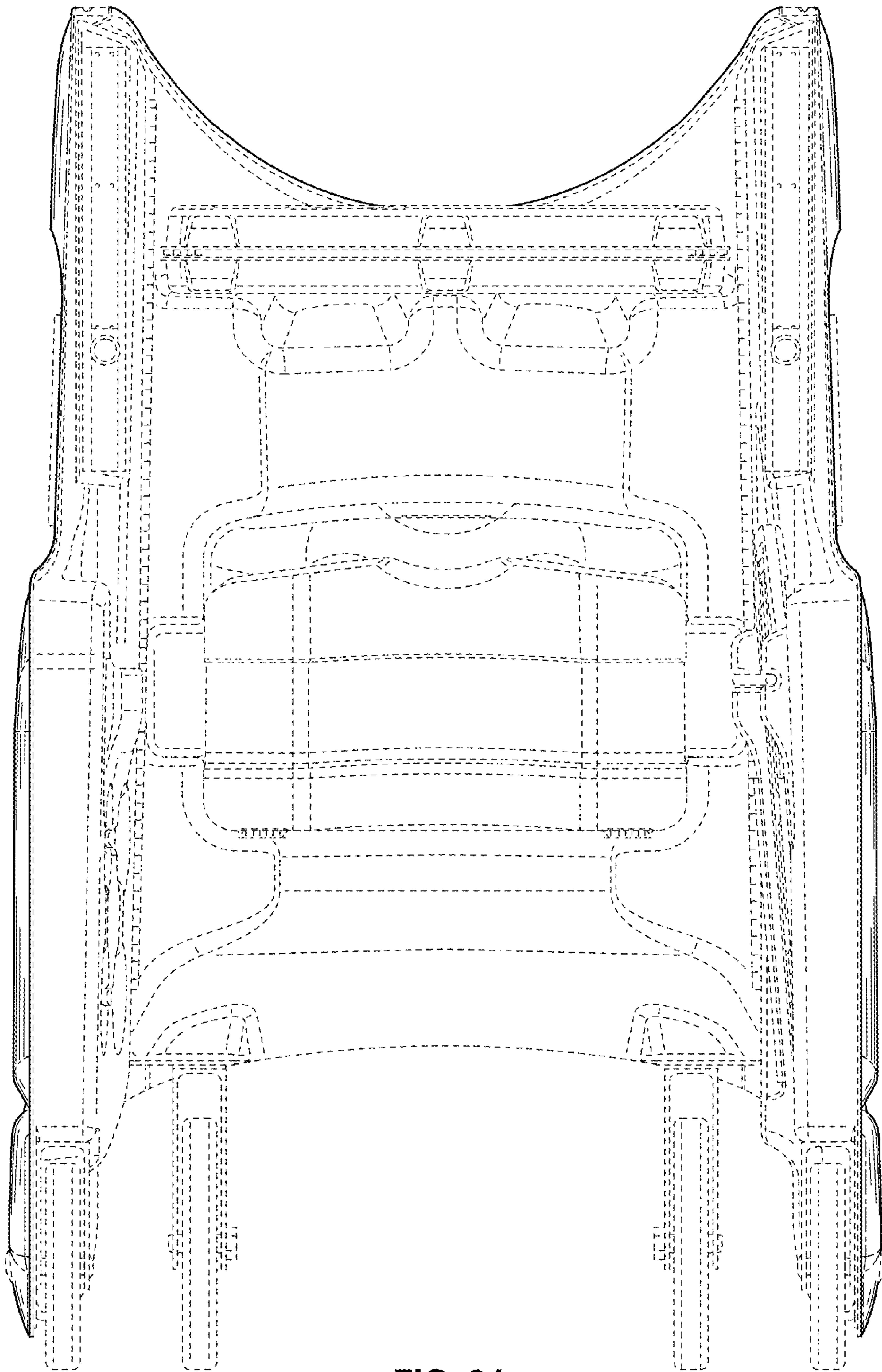

FIG. 34

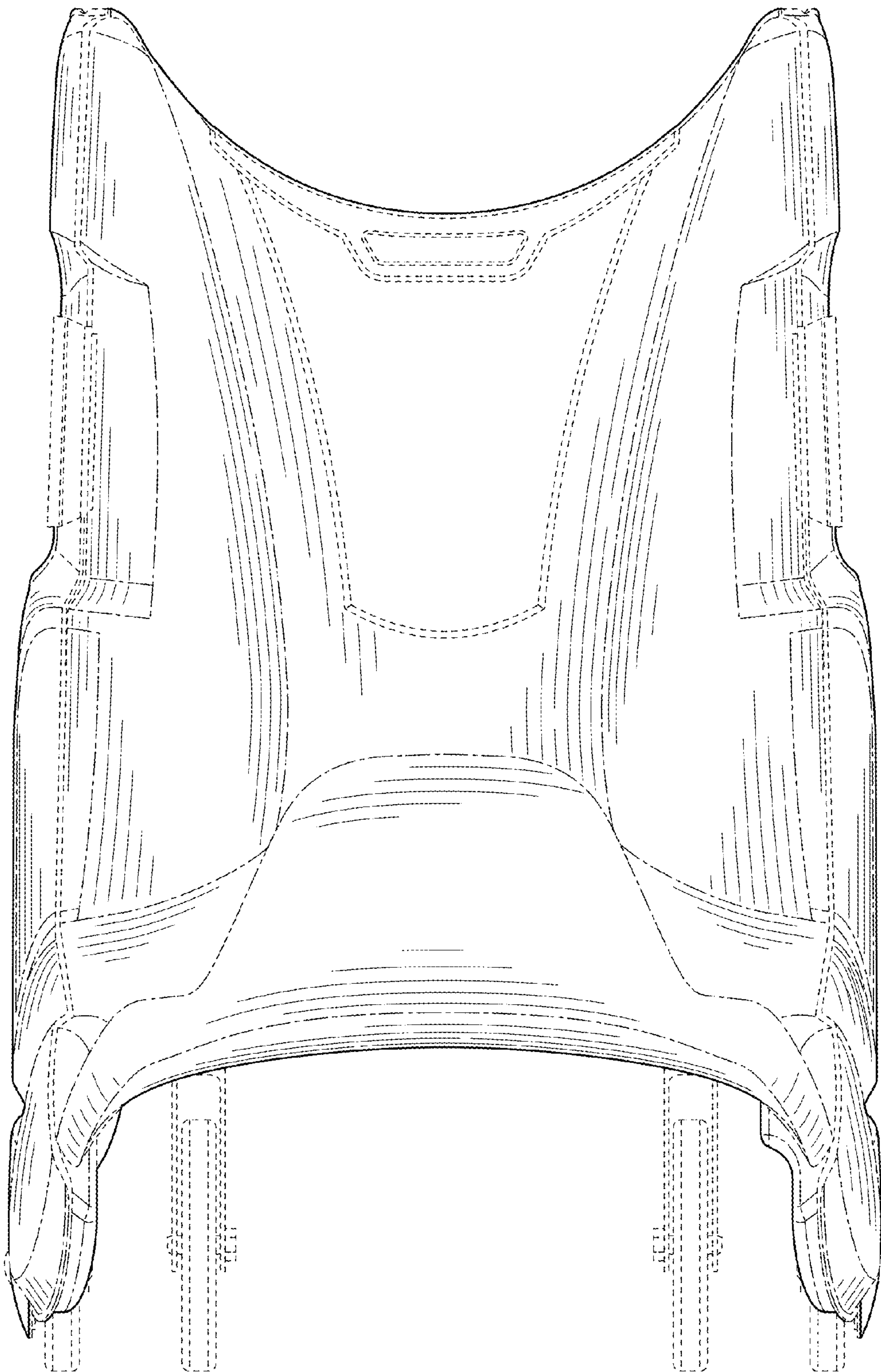

FIG. 35

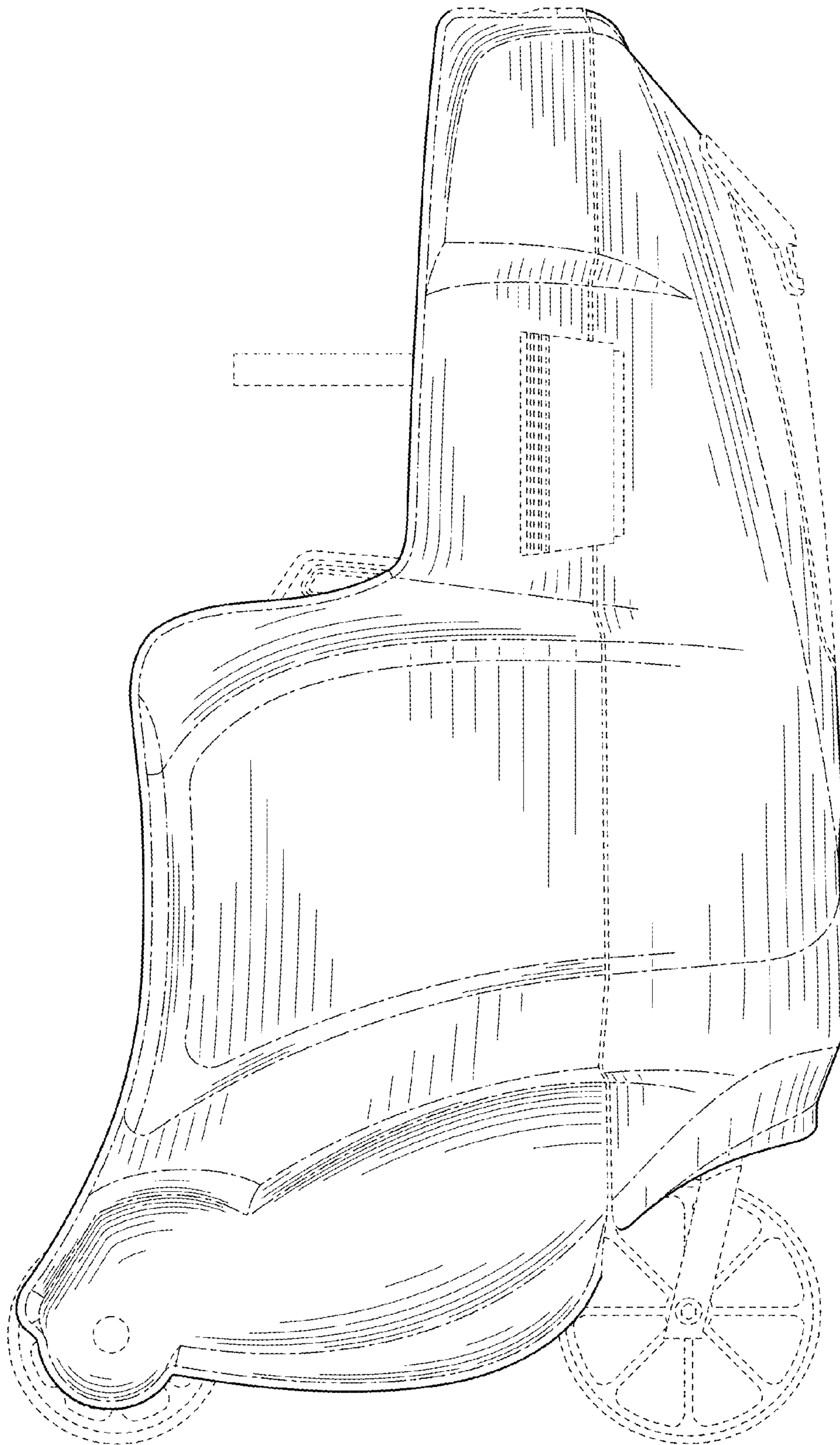

FIG. 36

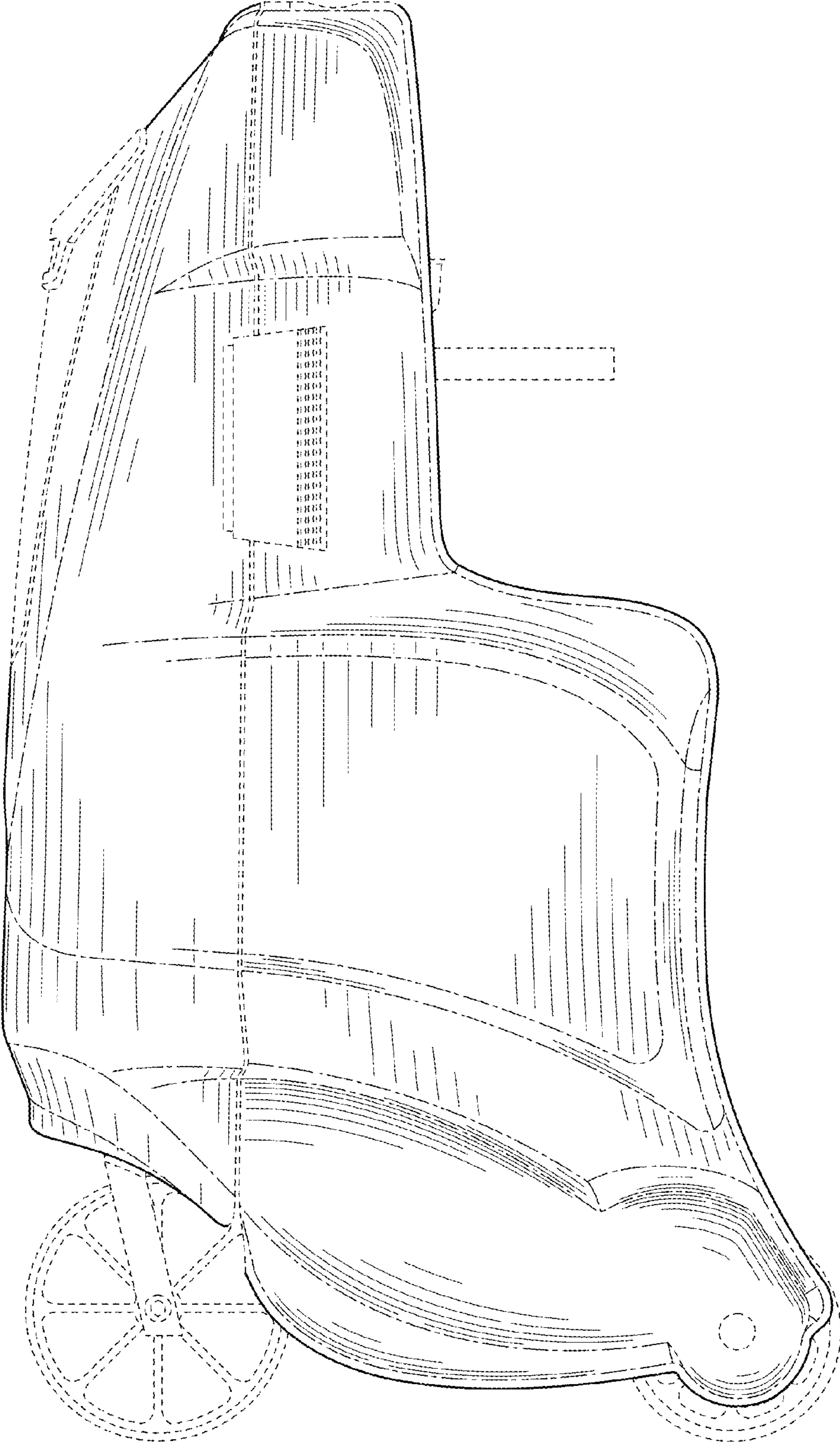

FIG. 37

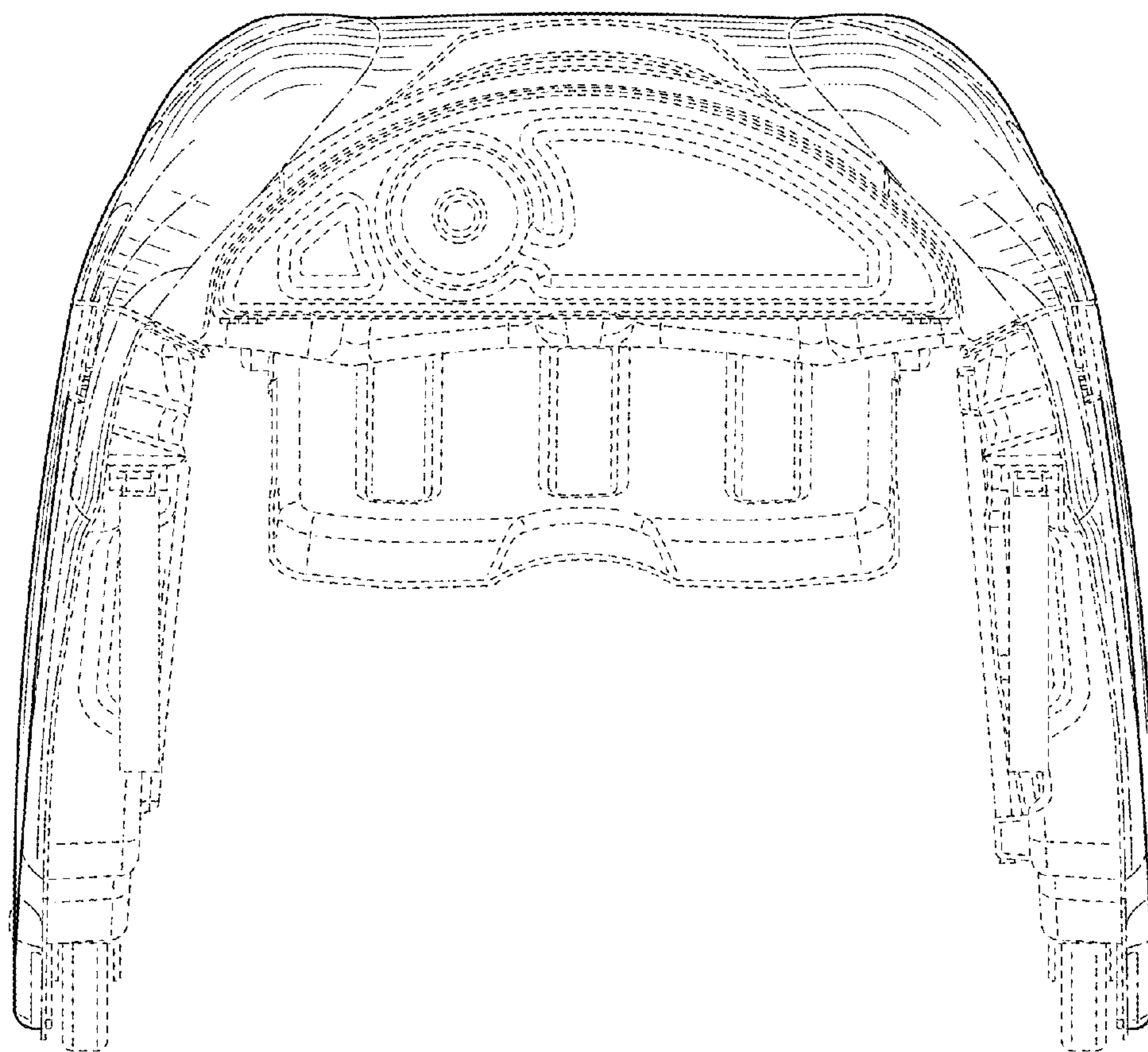

FIG. 38

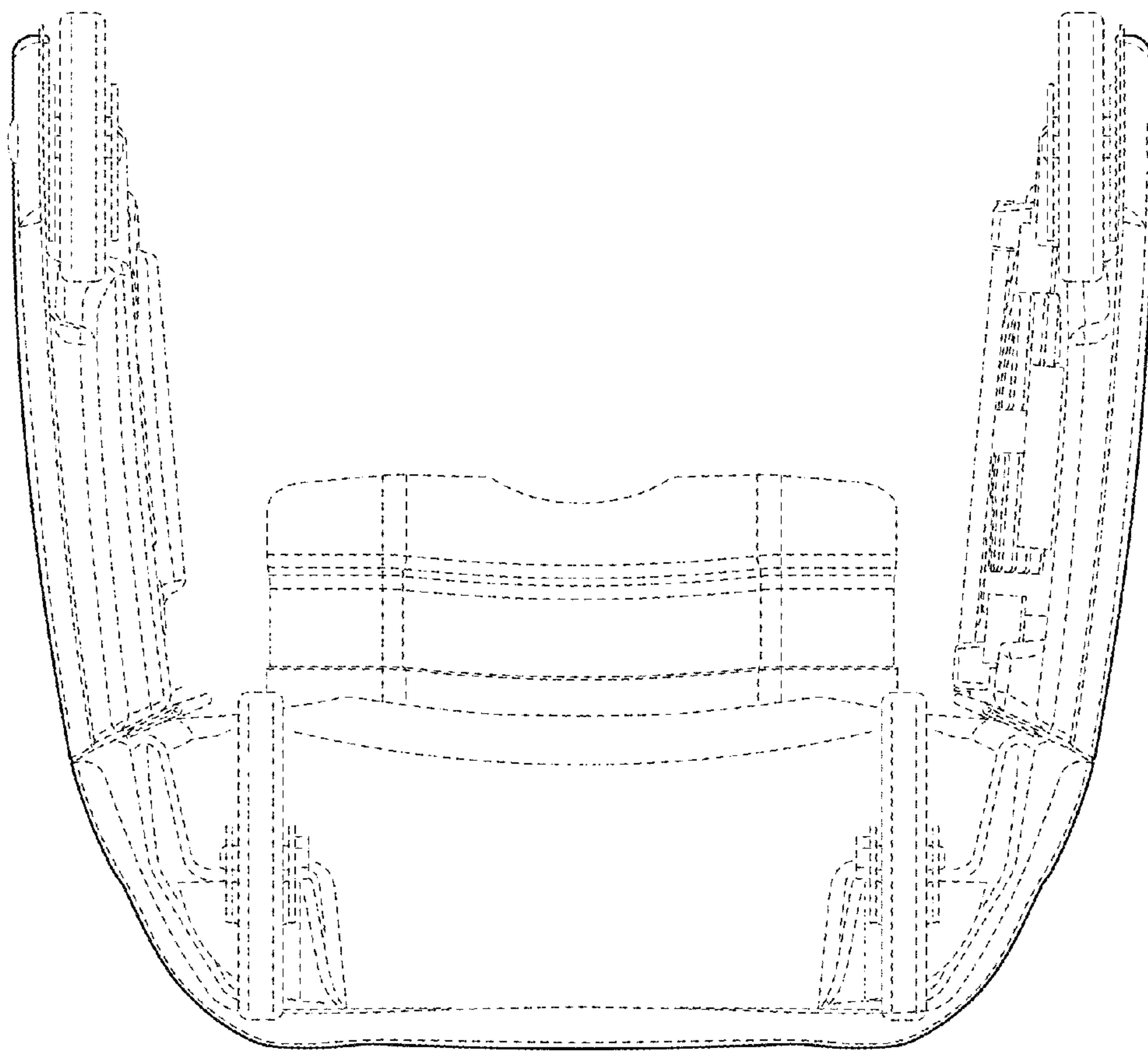

FIG. 39

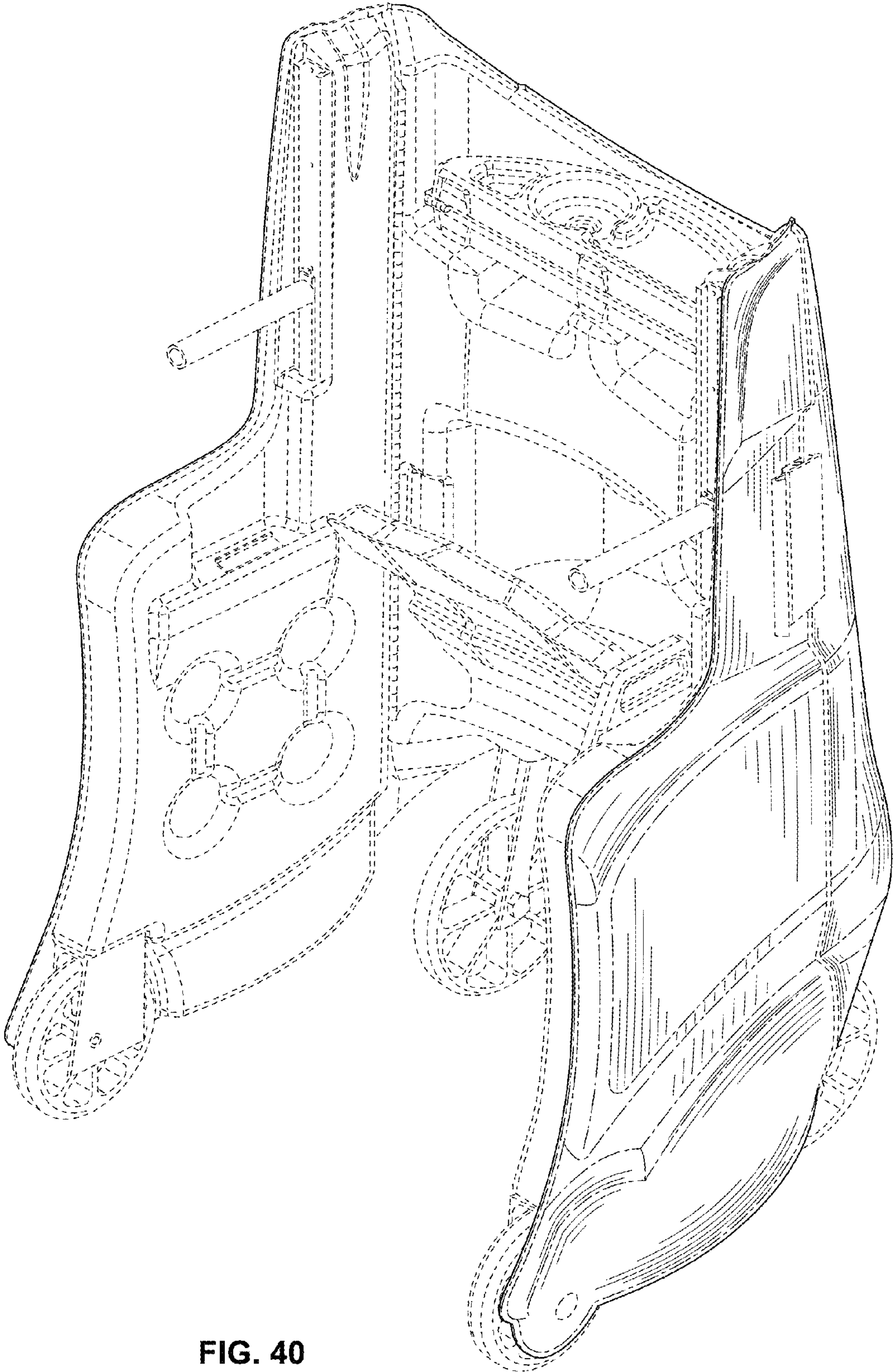

FIG. 40