



US00D766778S

(12) **United States Design Patent**
Lian et al.

(10) **Patent No.:** **US D766,778 S**

(45) **Date of Patent:** **** Sep. 20, 2016**

(54) **VEHICLE**

(56)

References Cited

(71) Applicant: **BYD COMPANY LIMITED**,
Guangdong (CN)

(72) Inventors: **Yubo Lian**, Guangdong (CN);
Changshu Shangguan, Guangdong
(CN); **Wenxi Zhu**, Guangdong (CN);
Xiaoming Zhong, Guangdong (CN);
Kuishan Du, Guangdong (CN)

(73) Assignee: **BYD COMPANY LIMITED**,
Shenzhen, Guangdong (CN)

U.S. PATENT DOCUMENTS

D591,647 S *	5/2009	Wang	D12/91
D608,690 S *	1/2010	Folden	D12/91
D608,691 S *	1/2010	Zak, Jr.	D12/91
D637,109 S *	5/2011	Muller	D12/91
D700,105 S *	2/2014	Kochi	D12/91
D728,422 S *	5/2015	Minami	D12/91
D731,924 S *	6/2015	Lian	D12/91
D732,433 S *	6/2015	Aengenheyster	D12/91
D733,004 S *	6/2015	Huang	D12/91
D735,611 S *	8/2015	Aengenheyster	D12/91
D743,303 S *	11/2015	Huang	D12/91

* cited by examiner

(**) Term: **15 Years**

Primary Examiner — Melody N Brown

(21) Appl. No.: **29/529,974**

(74) *Attorney, Agent, or Firm* — Morgan, Lewis & Bockius LLP

(22) Filed: **Jun. 11, 2015**

(57) **CLAIM**

The ornamental design for a vehicle, substantially as shown and described.

(30) **Foreign Application Priority Data**

DESCRIPTION

Jan. 5, 2015 (CN) 2015 3 0001936

(51) **LOC (10) Cl.** **12-08**

(52) **U.S. Cl.**
USPC **D12/91**

(58) **Field of Classification Search**
USPC D12/86, 90-92; D21/421, 433, 434;
296/181.1, 181.5
CPC B62D 35/00; B62D 25/00; B62D 25/06;
B62D 33/00

FIG. 1 is a front elevational view of a vehicle showing our new design;
FIG. 2 is a rear elevational view thereof;
FIG. 3 is a side elevational view thereof;
FIG. 4 is an opposite side elevational view thereof;
FIG. 5 is a top plan view thereof;
FIG. 6 is a front perspective view thereof; and,
FIG. 7 is a rear perspective view thereof.

See application file for complete search history.

1 Claim, 4 Drawing Sheets

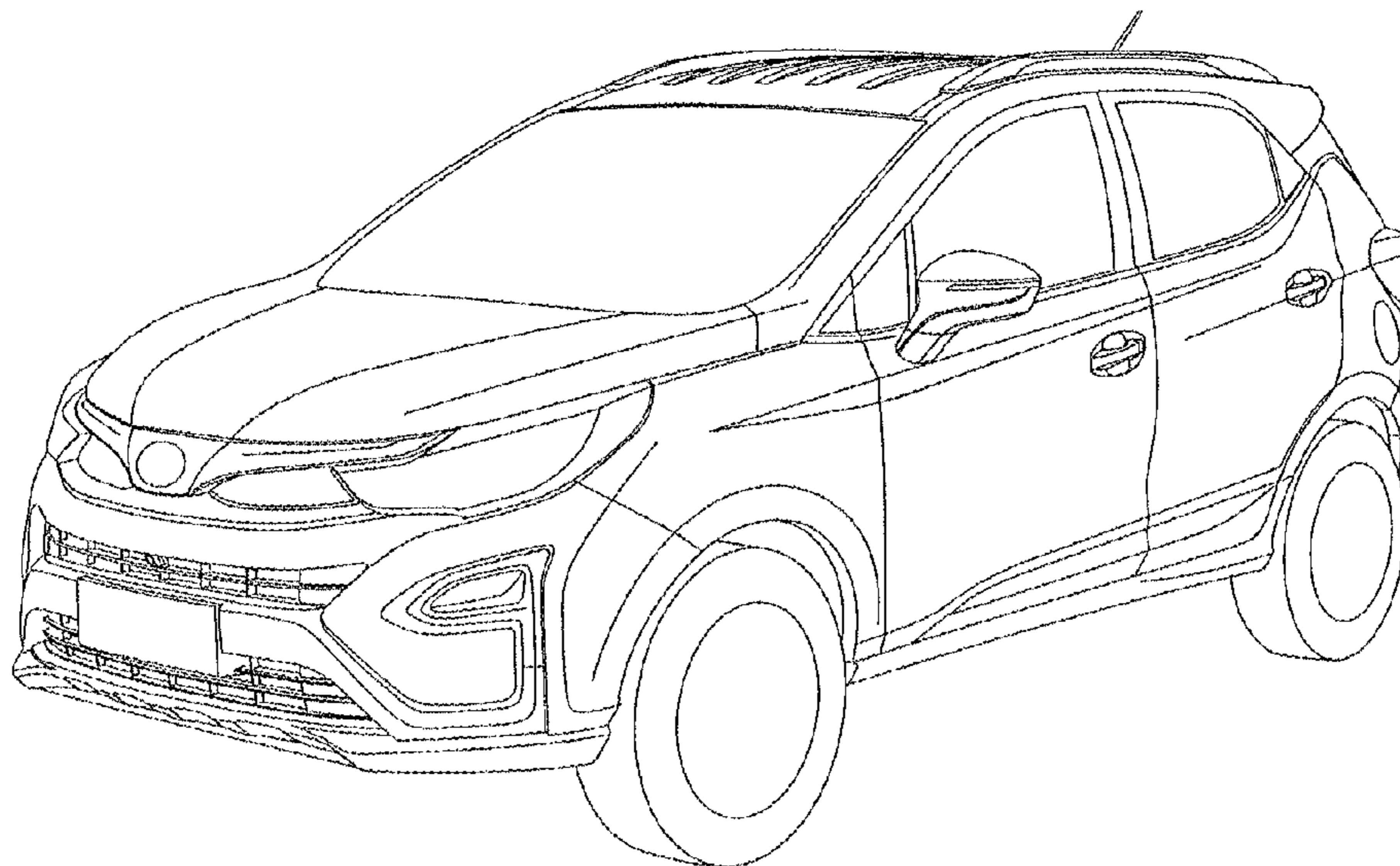

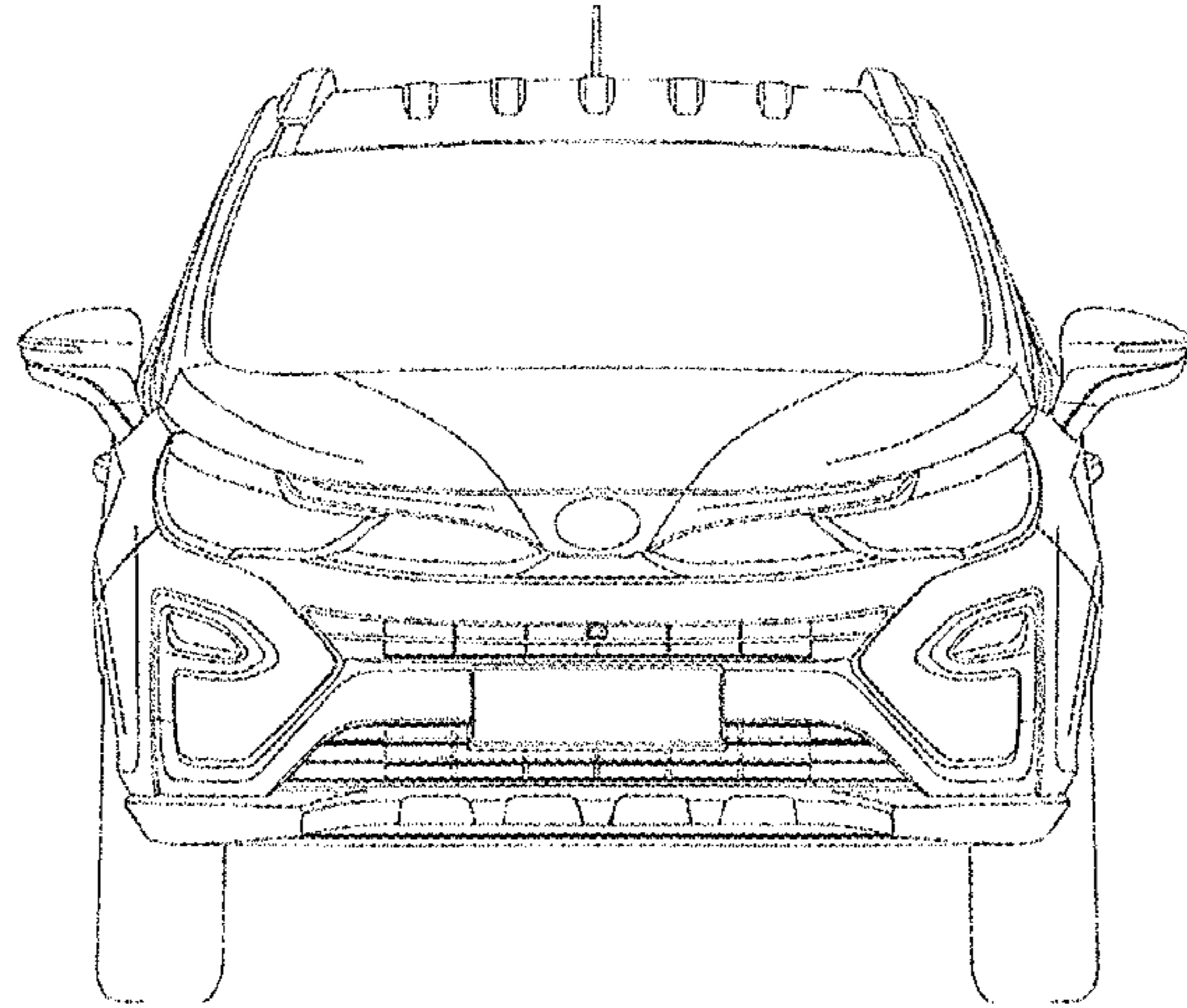

FIG. 1

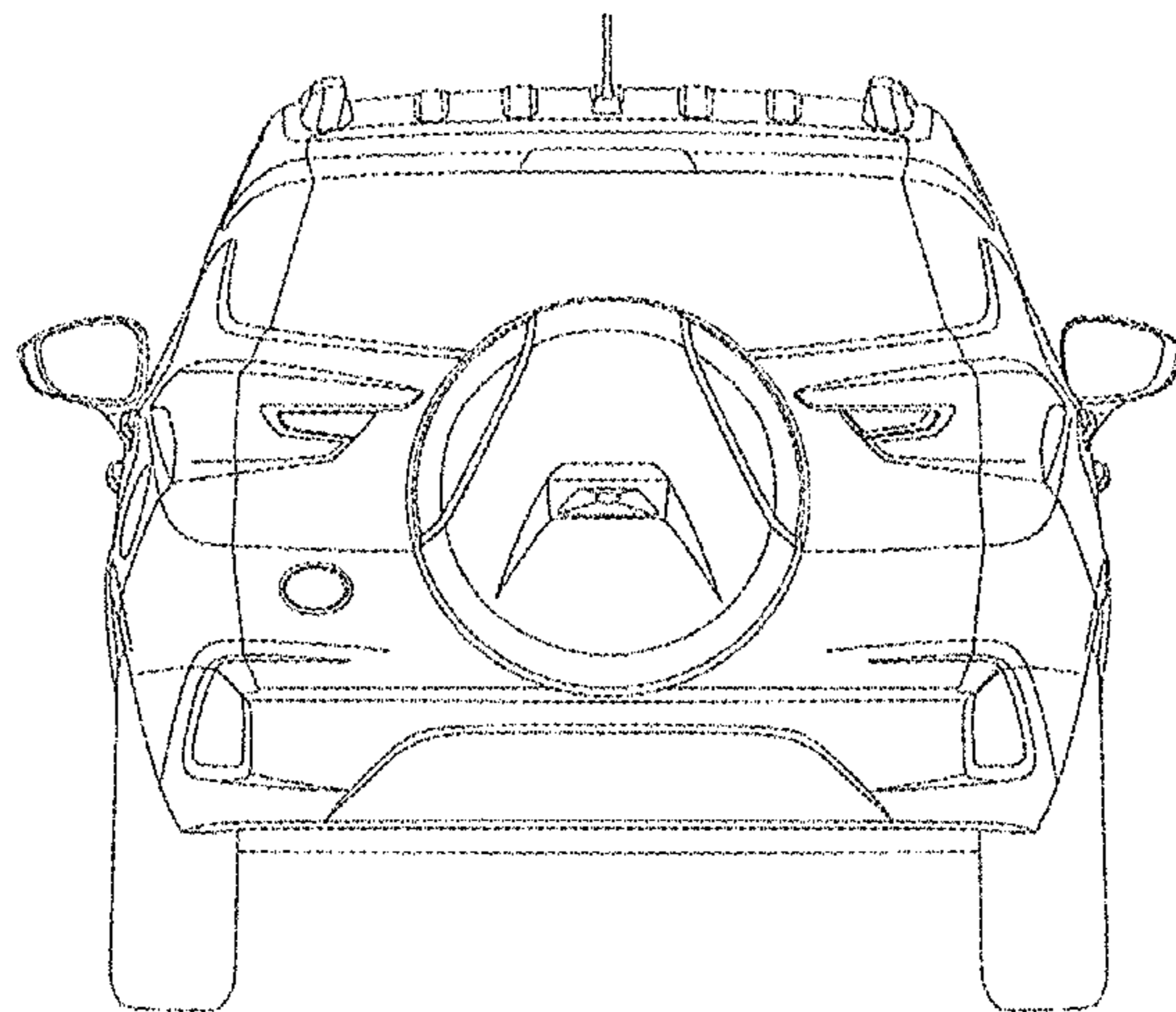

FIG. 2

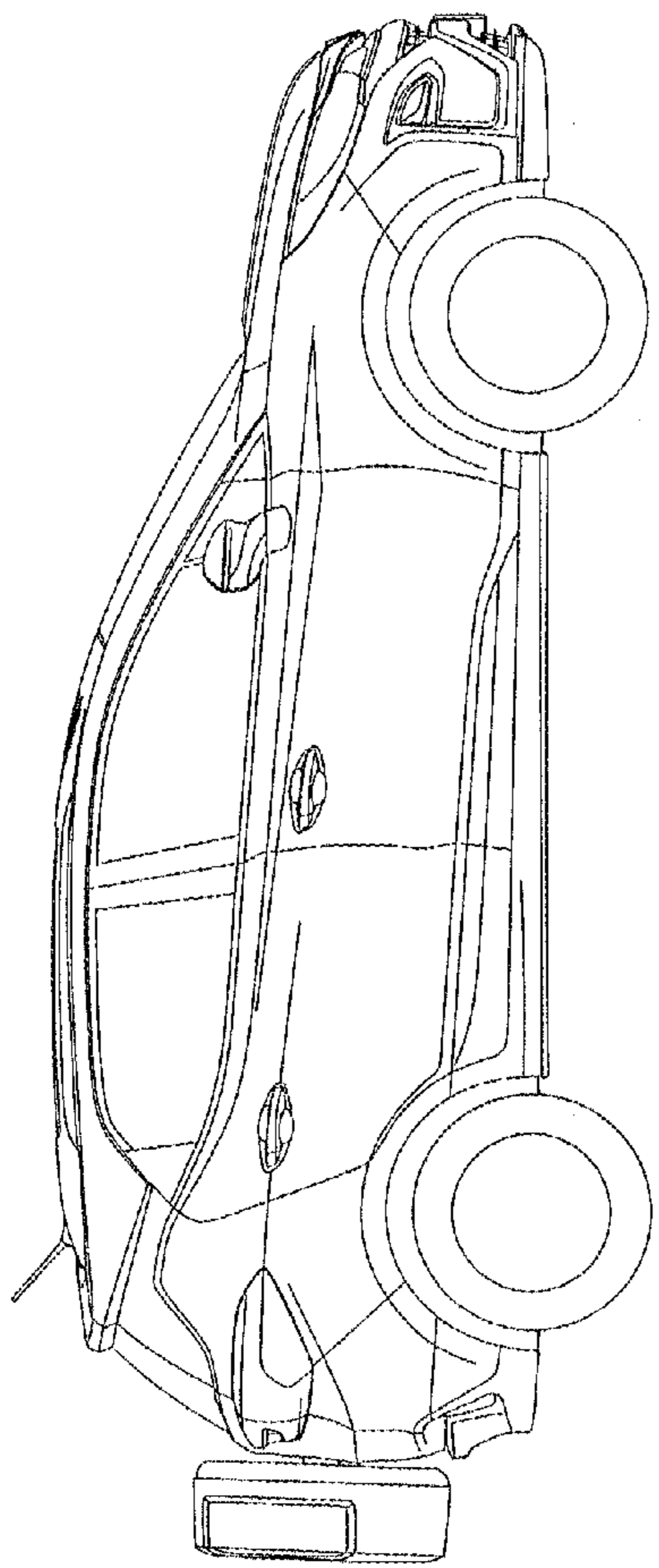

FIG. 3

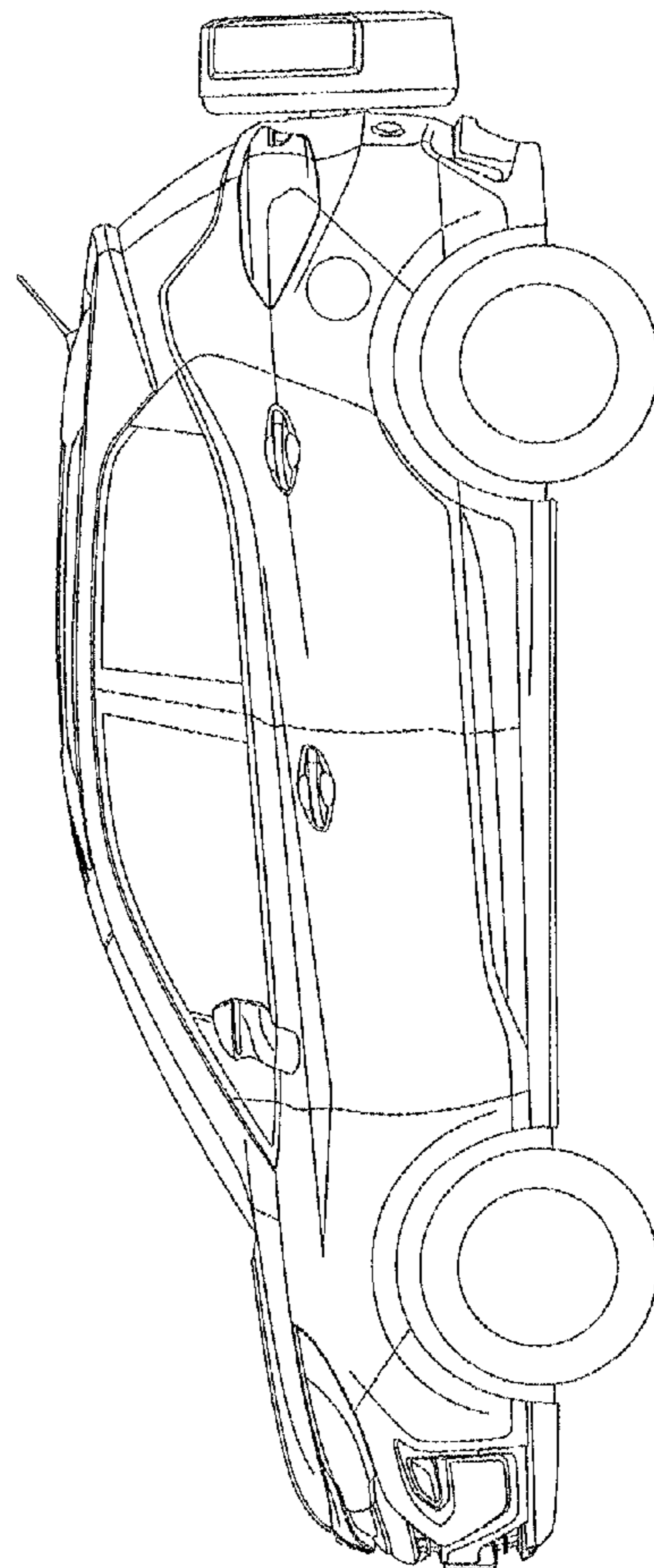

FIG. 4

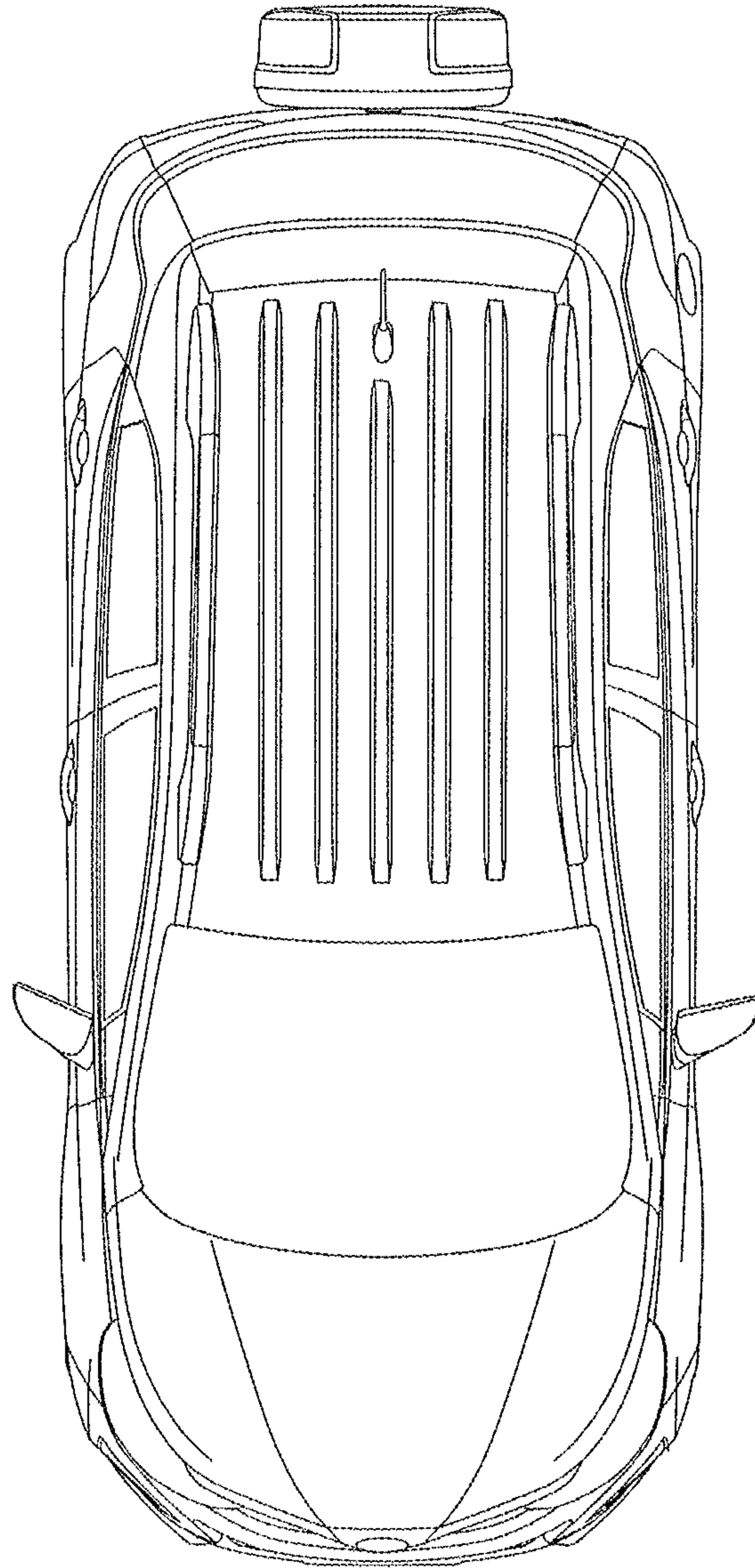

FIG. 5

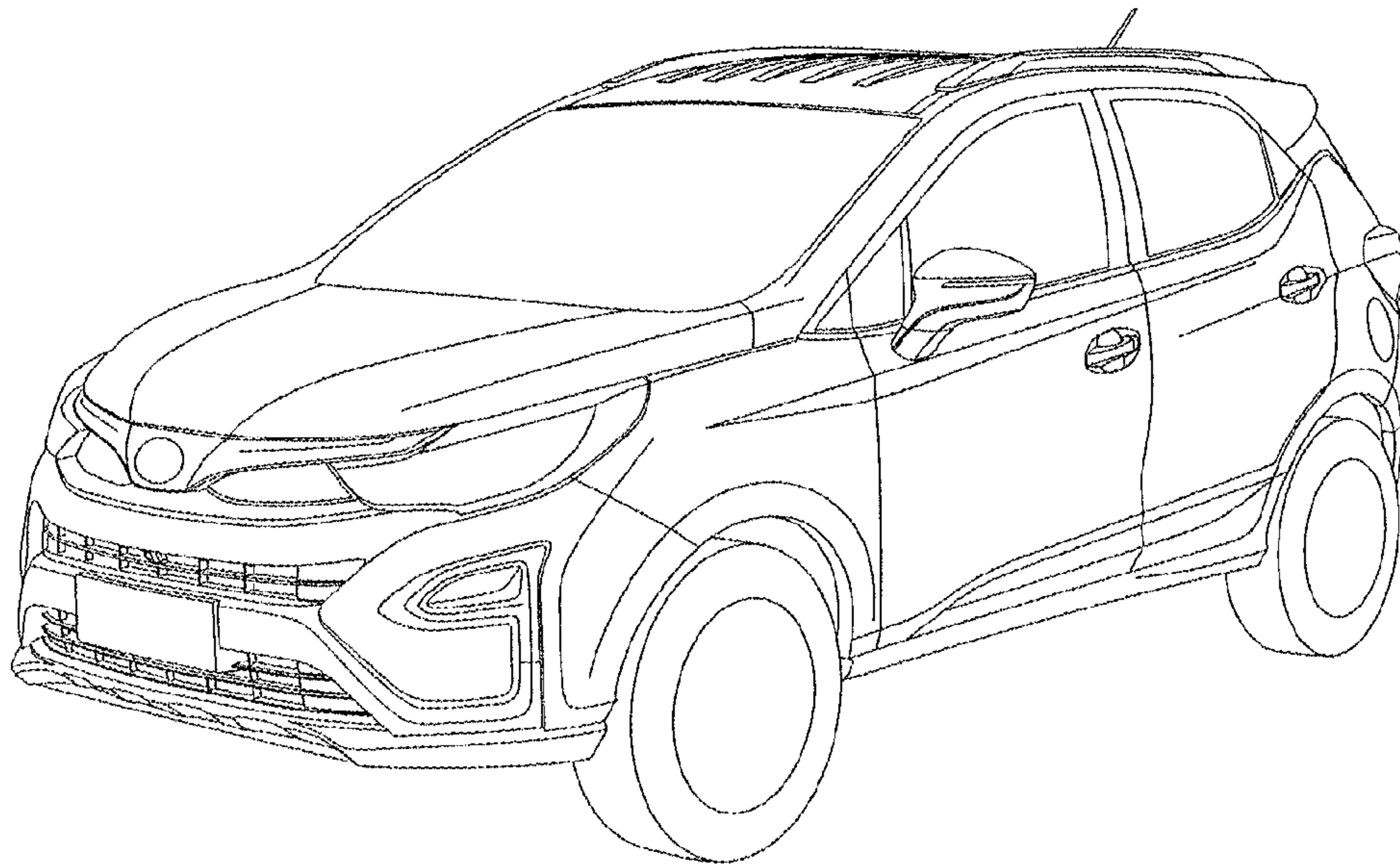

FIG. 6

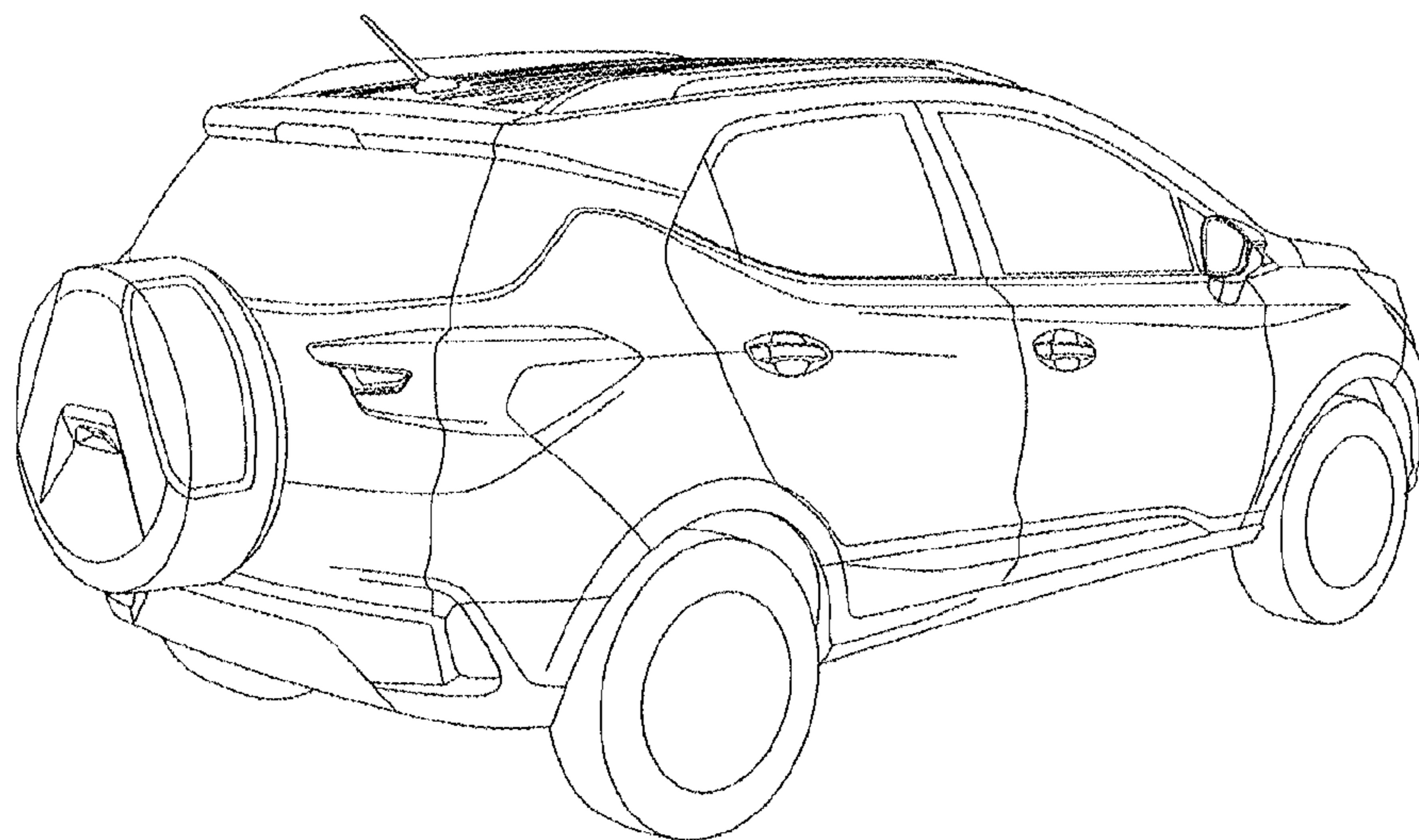

FIG. 7