

US00D766739S

(12) **United States Design Patent** (10) **Patent No.:** **US D766,739 S**
Pheir (45) **Date of Patent:** **** Sep. 20, 2016**

(54) **CONTAINER HAVING ROUNDED COMPARTMENTS**

3,295,710 A 1/1967 Marchant
3,386,607 A * 6/1968 Keene B65D 1/225
206/140

(71) Applicant: **Hirshol H. Pheir**, St. Thomas, VI (US)

(Continued)

(72) Inventor: **Hirshol H. Pheir**, St. Thomas, VI (US)

FOREIGN PATENT DOCUMENTS

(**) Term: **14 Years**

DE 102 07 763 A1 9/2003
FR 1 503 901 12/1967

(21) Appl. No.: **29/517,512**

(Continued)

(22) Filed: **Feb. 13, 2015**

OTHER PUBLICATIONS

(51) **LOC (10) Cl.** **09-03**

PCT International Search Report and Written Opinion, International Application No. PCT/US2015/015750, Dated Sep. 30, 2015, pp. 1-11.

(52) **U.S. Cl.**

USPC **D9/756**

(Continued)

(58) **Field of Classification Search**

USPC D9/737, 738, 740, 741, 747, 756, 782,
D9/516, 561, 414, 430; D7/509, 512, 513,
D7/523, 541, 549, 555, 557, 584, 308, 312,
D7/315, 325, 601, 602, 701, 707, 619.1;
D34/1, 5-7; D3/202, 201, 315, 316;
D6/663; 220/908-910, 500, 404, 401,
220/23.2, 23.6, 23.83; 312/198, 237, 238,
312/279, 385

Primary Examiner — Cathron Brooks
Assistant Examiner — Teddy Falloway
(74) *Attorney, Agent, or Firm* — Gibb & Riley, LLC

CPC B65D 11/00; B65D 25/04; B65D 1/04;
B65D 21/0201; B65D 25/38; B65D 43/168;
B65D 5/02; B65D 5/067; B65D 81/025;
Y10S 52/10

(57) **CLAIM**

The ornamental design for a container having rounded compartments, as shown and described.

See application file for complete search history.

DESCRIPTION

This application is related to the following co-pending applications filed concurrently herewith by the same Applicant: "Multi-Compartment Roll-Up Container" Ser. No. 14/621,542, "Multi-Compartment Roll-Up Container-Triangle", Ser. No. 29/517,510, and "Multi-Compartment Roll-Up Container-Rounded Different Sizes", Ser. No. 29/517,514. The complete disclosures of these co-pending applications are incorporated herein by reference.

FIG. 1 is a top perspective view of a container having rounded compartments showing our new design; FIG. 2 is a front elevation view thereof; FIG. 3 is a rear elevation view thereof; FIG. 4 is a left elevation view thereof; FIG. 5 is a right elevation view thereof; FIG. 6 is a top plan view thereof; and, FIG. 7 is a bottom plan view thereof.

(56) **References Cited**

U.S. PATENT DOCUMENTS

1,035,258 A * 8/1912 Stegman B65D 5/5495
206/258
1,190,196 A 7/1916 Schweinert et al.
2,665,816 A 1/1954 Anft
2,726,004 A * 12/1955 McLeod B65D 7/02
220/23.2
2,845,976 A 8/1958 Miller
D197,862 S * 3/1964 Wills et al. 206/471
D197,863 S * 3/1964 Wills et al. D9/756
3,206,897 A 9/1965 Hilker
3,257,154 A * 6/1966 Lewis A47B 49/00
312/198

1 Claim, 6 Drawing Sheets

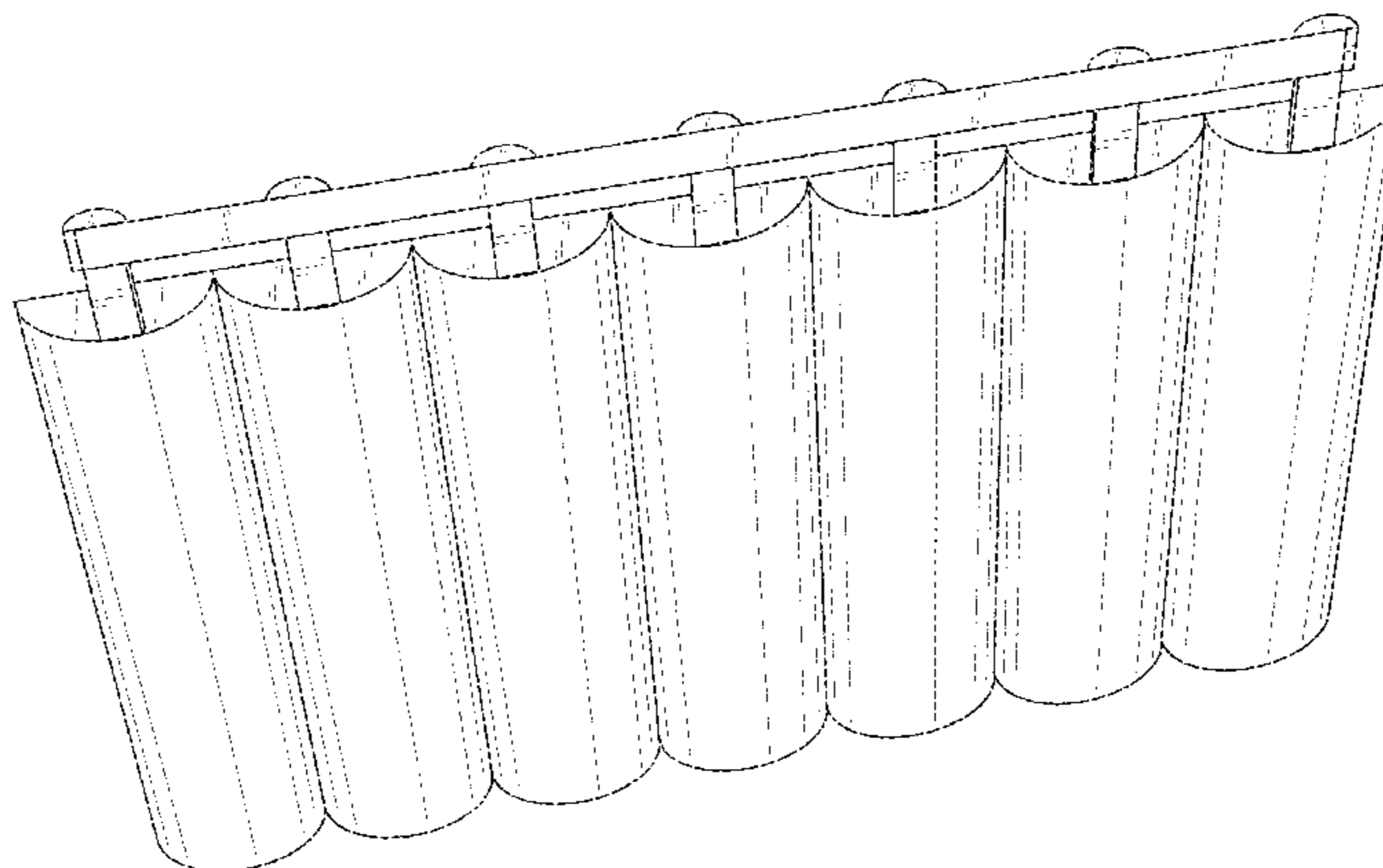

(56)

References Cited

U.S. PATENT DOCUMENTS

3,559,866 A 2/1971 Olson, Sr.
 3,785,545 A * 1/1974 Roussel B65D 5/5495
 206/431
 4,004,501 A 1/1977 Guerrero
 4,081,101 A 3/1978 West
 4,126,239 A 11/1978 Gehrig et al.
 4,320,846 A 3/1982 Meyering
 4,326,628 A 4/1982 Wood
 4,799,590 A 1/1989 Furman
 4,890,741 A 1/1990 Edelstein
 D324,121 S 2/1992 Schierlinger
 5,135,823 A 8/1992 Eales
 5,344,006 A 9/1994 Mazzeo
 5,351,815 A 10/1994 Fogle et al.
 5,351,816 A 10/1994 Sutherland et al.
 5,615,765 A * 4/1997 Roericht A45C 11/04
 206/45.23
 5,676,253 A 10/1997 Hsu
 5,676,274 A 10/1997 Green et al.
 5,752,464 A 5/1998 King
 5,823,136 A 10/1998 Zarski
 D407,306 S * 3/1999 Saab D7/701
 D415,023 S 10/1999 Snyder
 D463,120 S 9/2002 Yoshinaka
 D468,535 S 1/2003 McCormack
 D489,271 S 5/2004 Soomar
 D556,321 S * 11/2007 Starnes D24/115
 D570,682 S 6/2008 Erden
 7,665,634 B2 2/2010 Pressler
 7,810,667 B2 10/2010 Douglas

8,338,357 B2 12/2012 Gibis et al.
 D702,998 S 4/2014 Fugere
 D711,254 S 8/2014 Madda et al.
 D711,255 S 8/2014 Madda et al.
 D724,893 S * 3/2015 Dirks D7/507
 9,084,480 B2 * 7/2015 Atwood
 D735,994 S 8/2015 Mangano
 9,199,767 B1 * 12/2015 Pheir B65D 25/04
 2004/0149774 A1 8/2004 Strong
 2010/0072265 A1 3/2010 Holloway
 2010/0243499 A1 9/2010 Slayton et al.
 2011/0095021 A1 4/2011 Clough
 2013/0206772 A1 8/2013 Halbherr et al.

FOREIGN PATENT DOCUMENTS

GB 2 305 162 4/1997
 WO 01/44065 A1 6/2001
 WO 2005/110872 A1 11/2005

OTHER PUBLICATIONS

Notice of Allowance Communication, U.S. Appl. No. 14/621,542,
 Dated Sep. 24, 2015, pp. 1-9.
 Notice of Allowance Communication, U.S. Appl. No. 29/517,510,
 Dated Mar. 23, 2016, pp. 1-8.
 Office Action Communication, U.S. Appl. No. 29/517,514, dated
 Mar. 18, 2016, pp. 1-8.
 Notice of Allowance Communication, U.S. Appl. No. 29/517,514
 Dated Jun. 29, 2016, pp. 1-5.

* cited by examiner

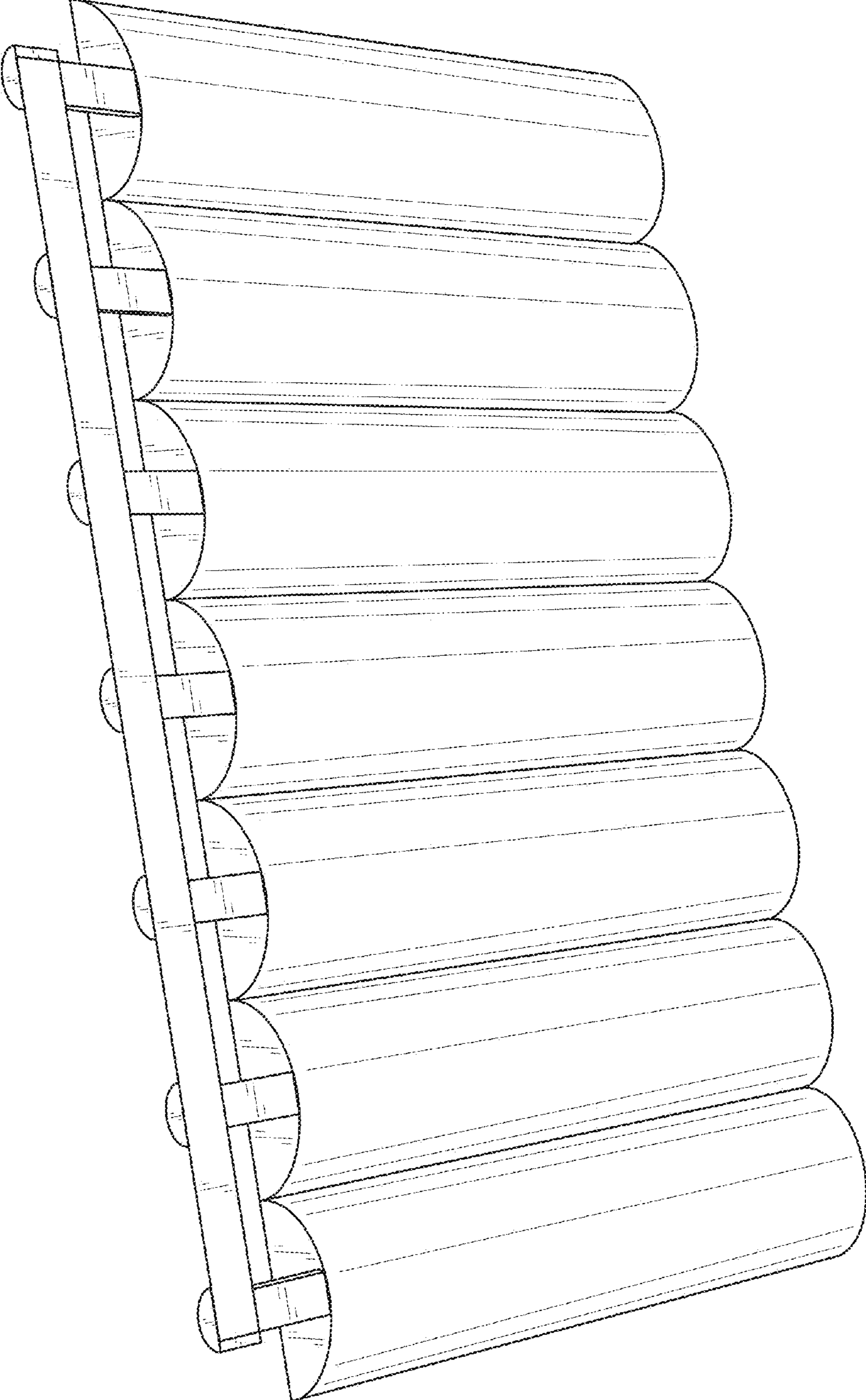

FIG. 1

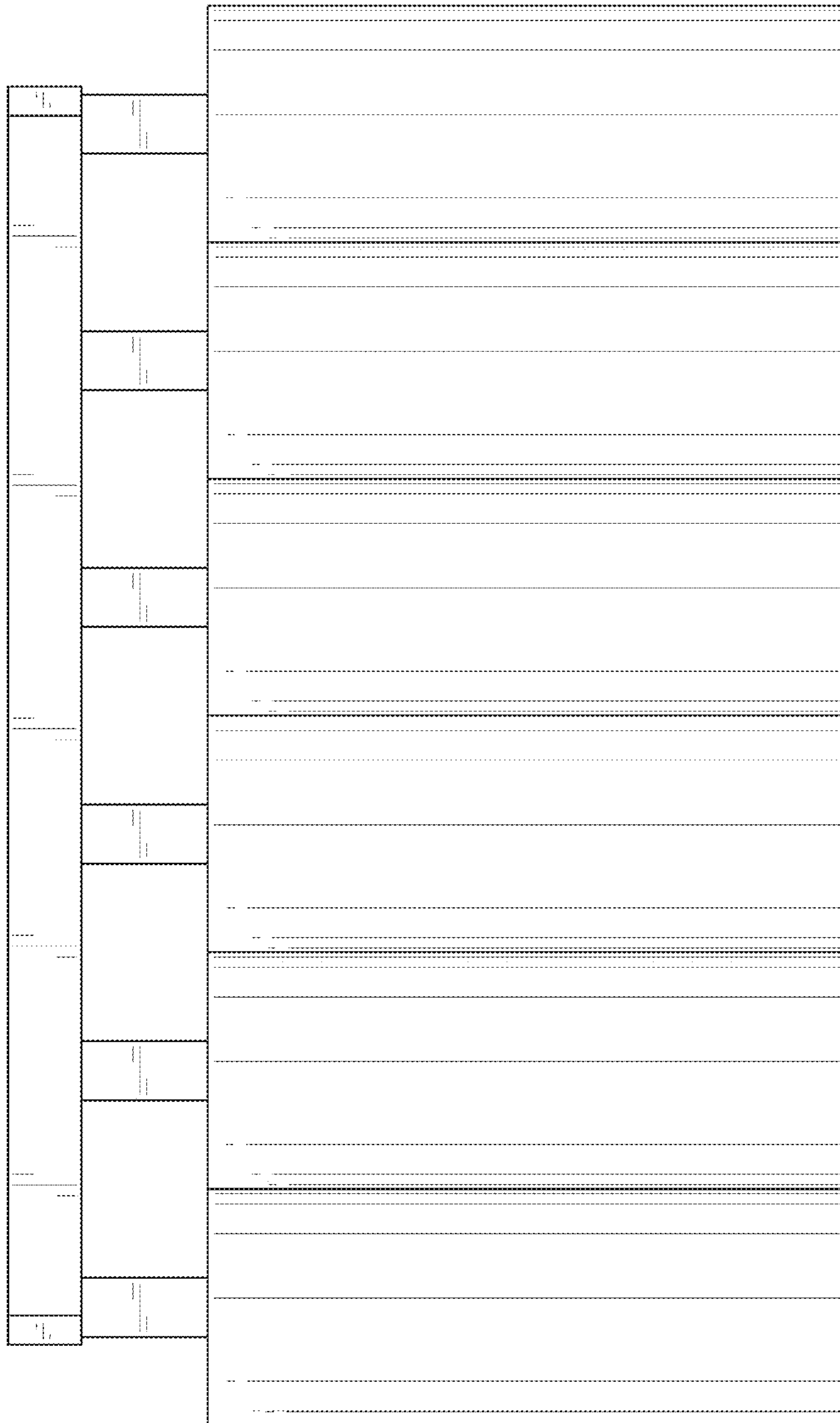

FIG. 2

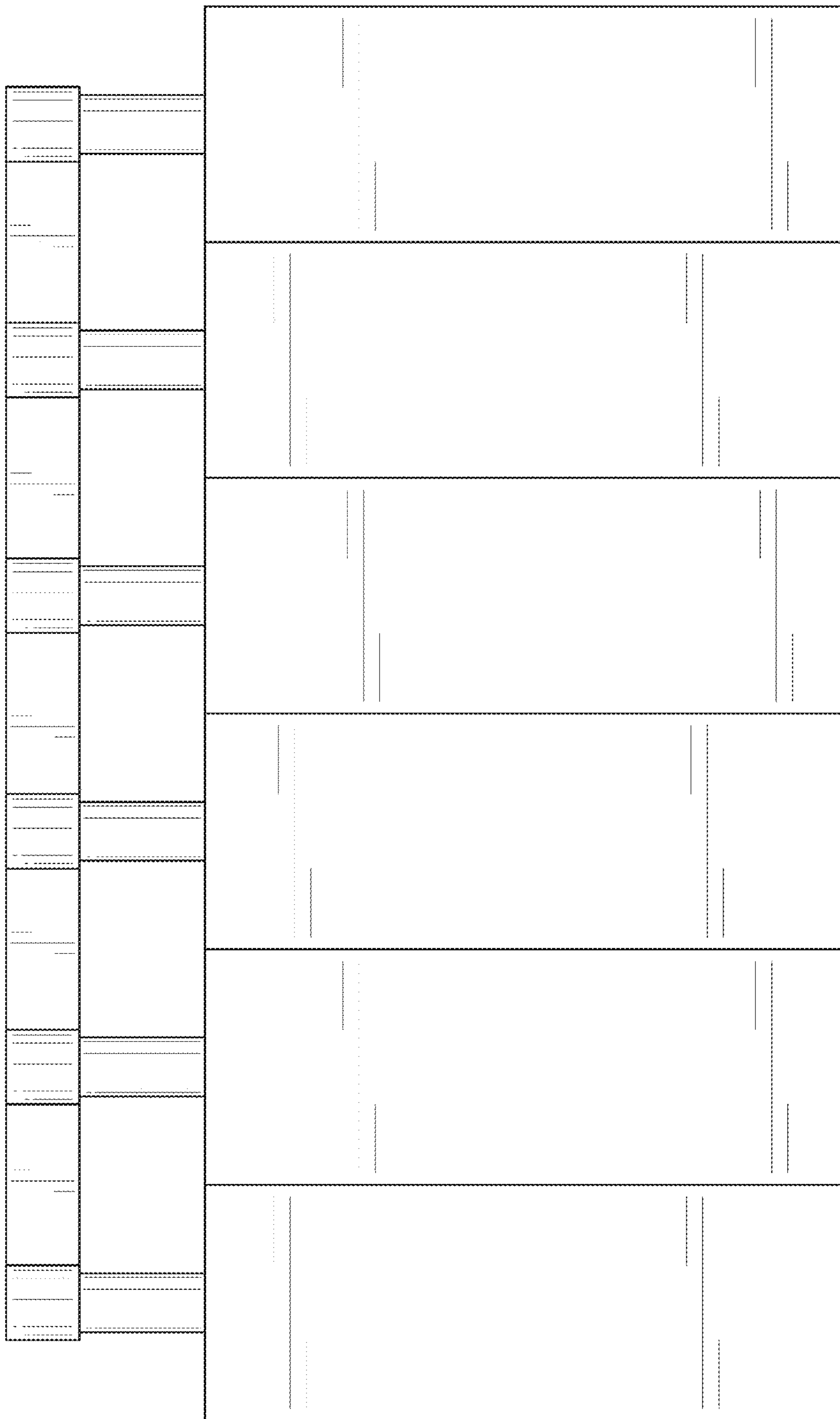

FIG. 3

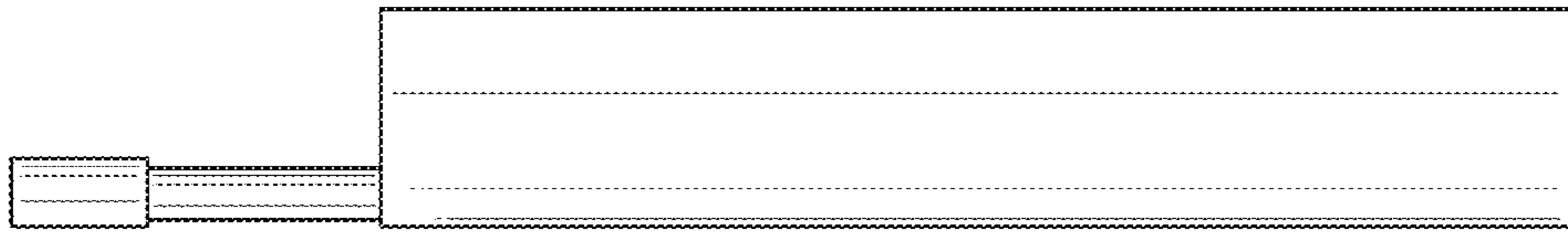

FIG. 5

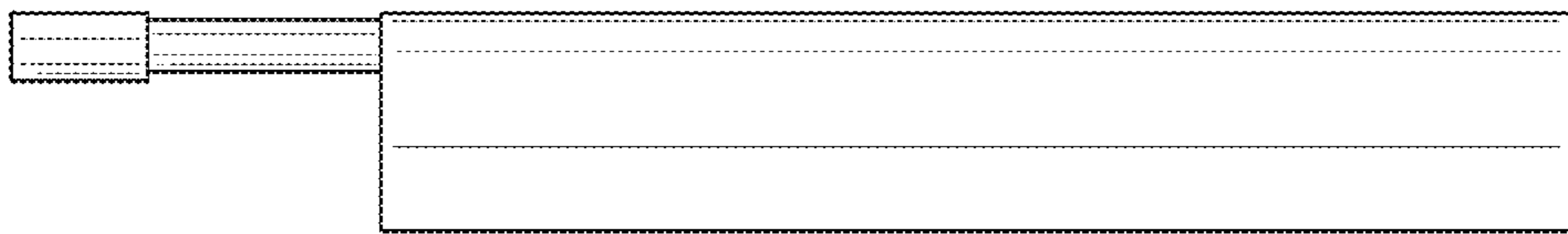

FIG. 4

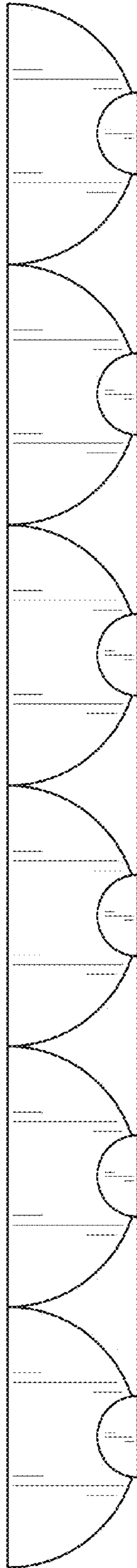

FIG. 6

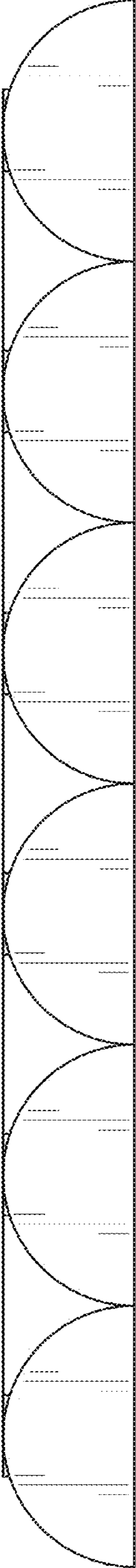

FIG. 7