

US00D766729S

(12) **United States Design Patent** (10) **Patent No.:** **US D766,729 S**  
**Delgado Carmona** (45) **Date of Patent:** **\*\* Sep. 20, 2016**

(54) **BOTTLE WITH OWL SHAPE**  
(71) Applicant: **Dart Industries Inc.**, Orlando, FL (US)  
(72) Inventor: **Sara L. Delgado Carmona**, Orlando, FL (US)

D336,941 S \* 6/1993 Leung ..... D21/606  
D603,465 S \* 11/2009 Kelly ..... D21/606  
D663,790 S \* 7/2012 Williams ..... D21/606  
D699,946 S \* 2/2014 Lee ..... D3/271.1  
D713,260 S 9/2014 Delgado Carmona  
D713,261 S 9/2014 Delgado Carmona  
D721,592 S \* 1/2015 Peng ..... D9/602

(73) Assignee: **Dart Industries Inc.**, Orlando, FL (US)

\* cited by examiner

(\*\*) Term: **15 Years**

*Primary Examiner* — Sandra Morris

(21) Appl. No.: **29/528,527**

(74) *Attorney, Agent, or Firm* — Taylor J. Ross

(22) Filed: **May 29, 2015**

(51) **LOC (10) Cl.** ..... **09-01**

(57) **CLAIM**

(52) **U.S. Cl.**  
USPC ..... **D9/602**

The ornamental design for a bottle with owl shape, as shown and described.

(58) **Field of Classification Search**  
USPC ..... D9/600–603, 607–613; 206/457, 494,  
206/459.5, 527, 540; 229/116.1; 446/77;  
215/381–384, 400; D7/514–516, 539,  
D7/544, 571, 579, 604, 613, 619.2,  
D7/628–630, 391–392.1; D3/270–271.3;  
D21/606  
CPC ..... B65D 67/00; B65D 81/36; B65D 81/60;  
B65D 81/368; B65D 2203/00; B65D  
2203/02; A63H 33/16  
See application file for complete search history.

**DESCRIPTION**

FIG. 1 is a top, front and left side perspective view of a bottle with owl shape showing my new design;  
FIG. 2 is a top plan view thereof;  
FIG. 3 is a bottom plan view thereof. The broken lines in FIG. 3 are included for the purpose of illustrating a portion of the bottom that forms no part of the claimed design;  
FIG. 4 is a front elevation view thereof;  
FIG. 5 is a rear elevation view thereof;  
FIG. 6 is a left side elevation view thereof; and,  
FIG. 7 is a right side elevation view thereof.

(56) **References Cited**

U.S. PATENT DOCUMENTS

D238,906 S \* 2/1976 Cone ..... D21/606  
3,976,807 A \* 8/1976 Sweeney ..... B44F 9/00  
206/457

**1 Claim, 4 Drawing Sheets**

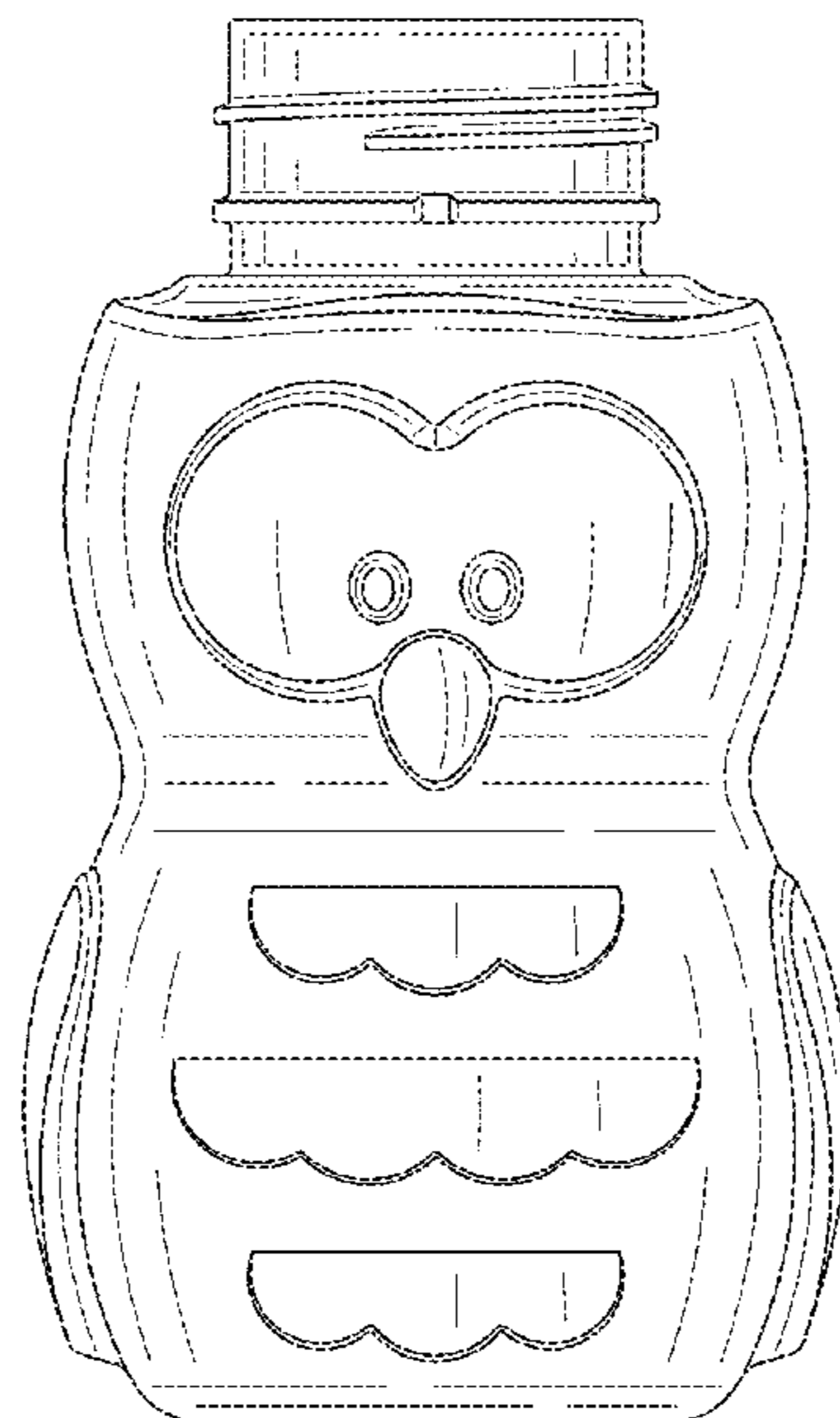

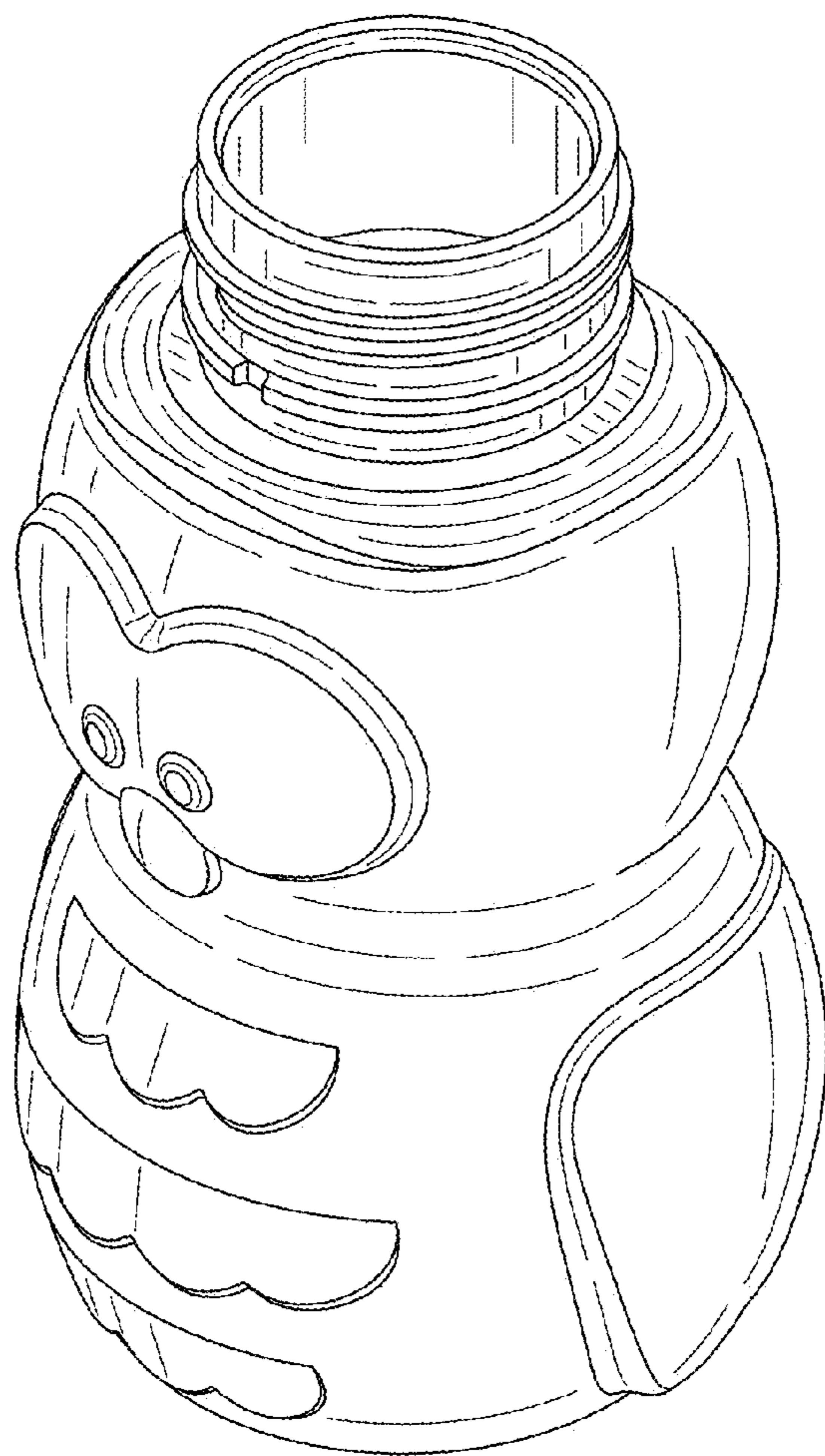

FIG. 1

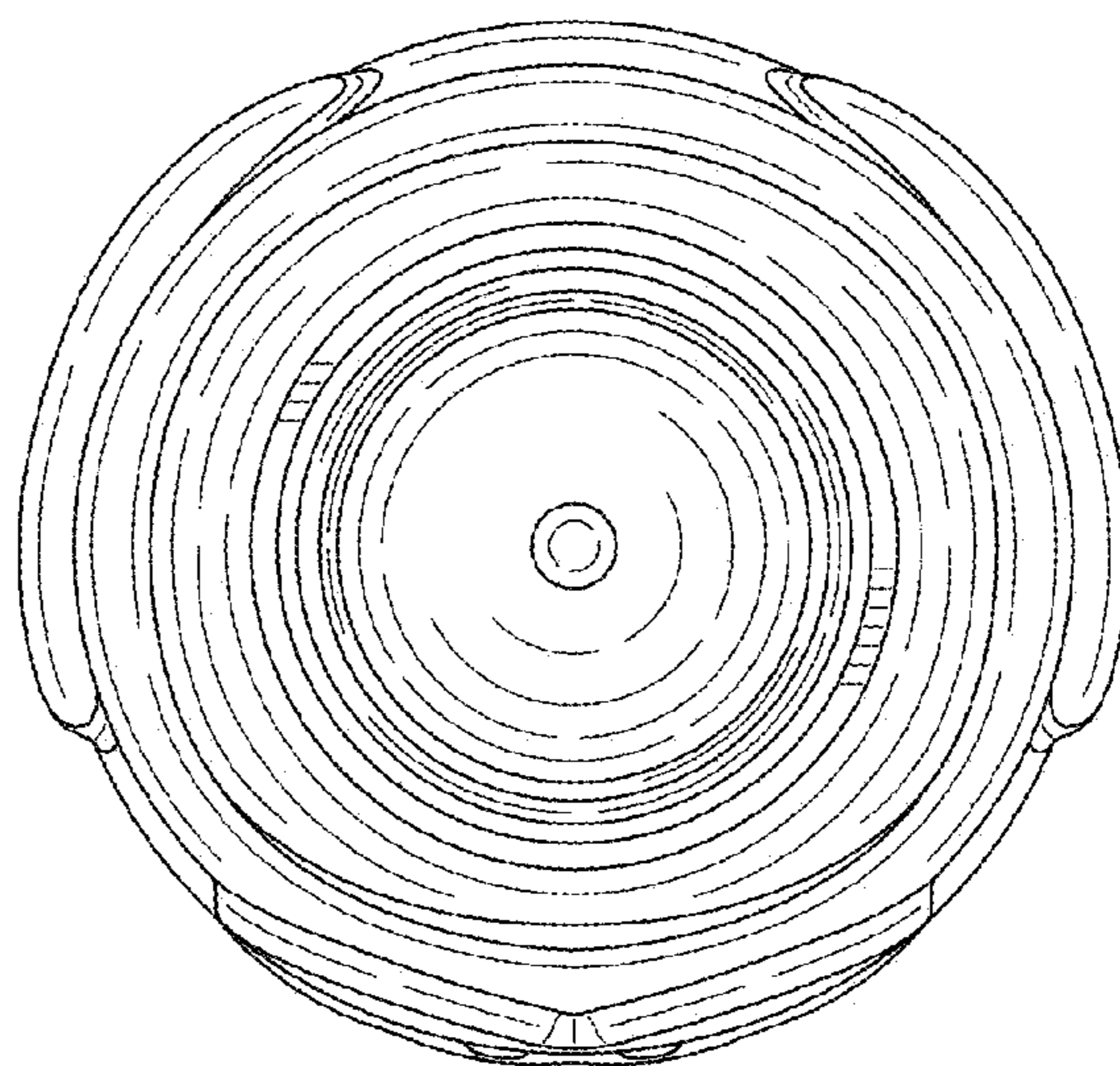

FIG. 2

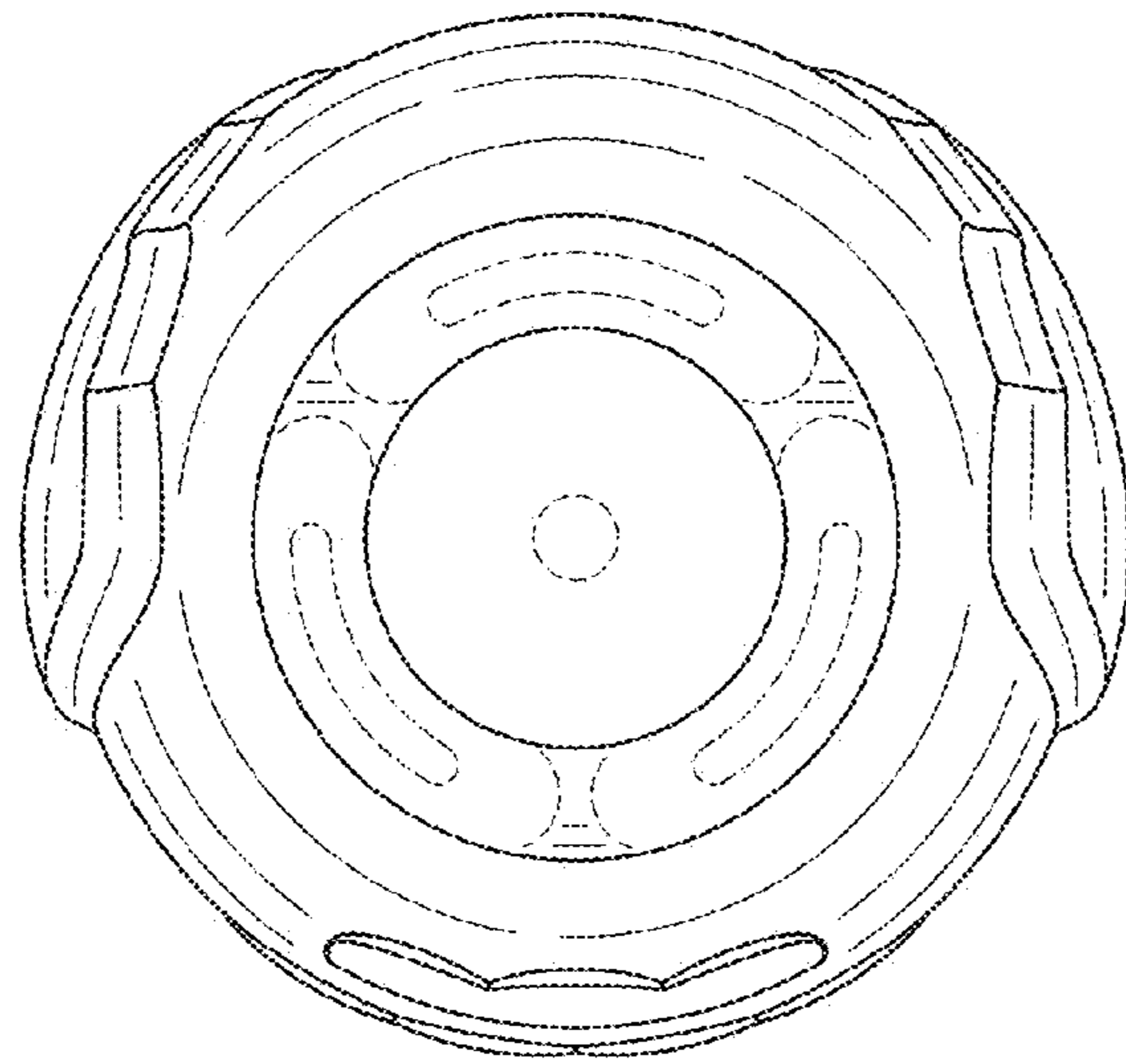

FIG. 3

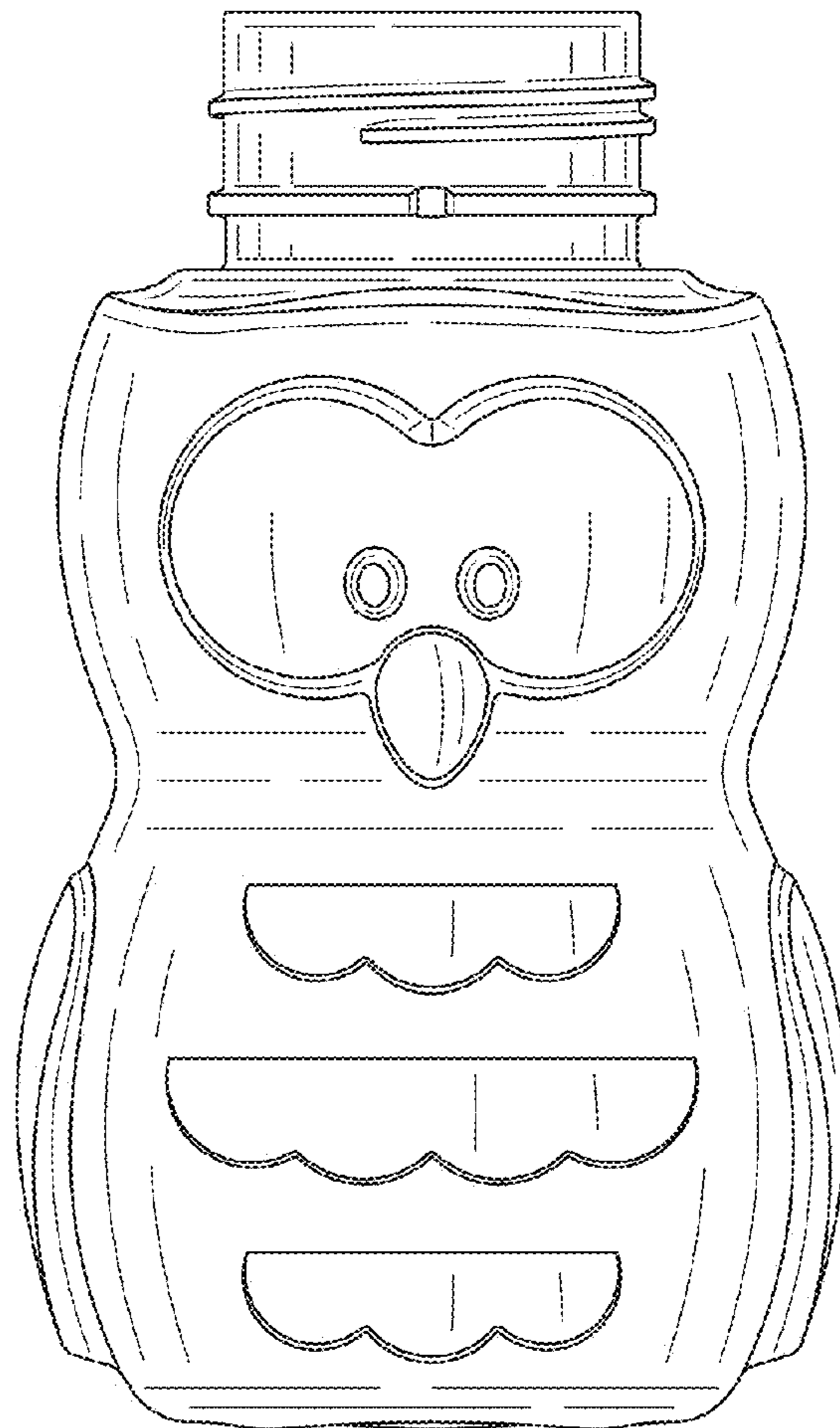
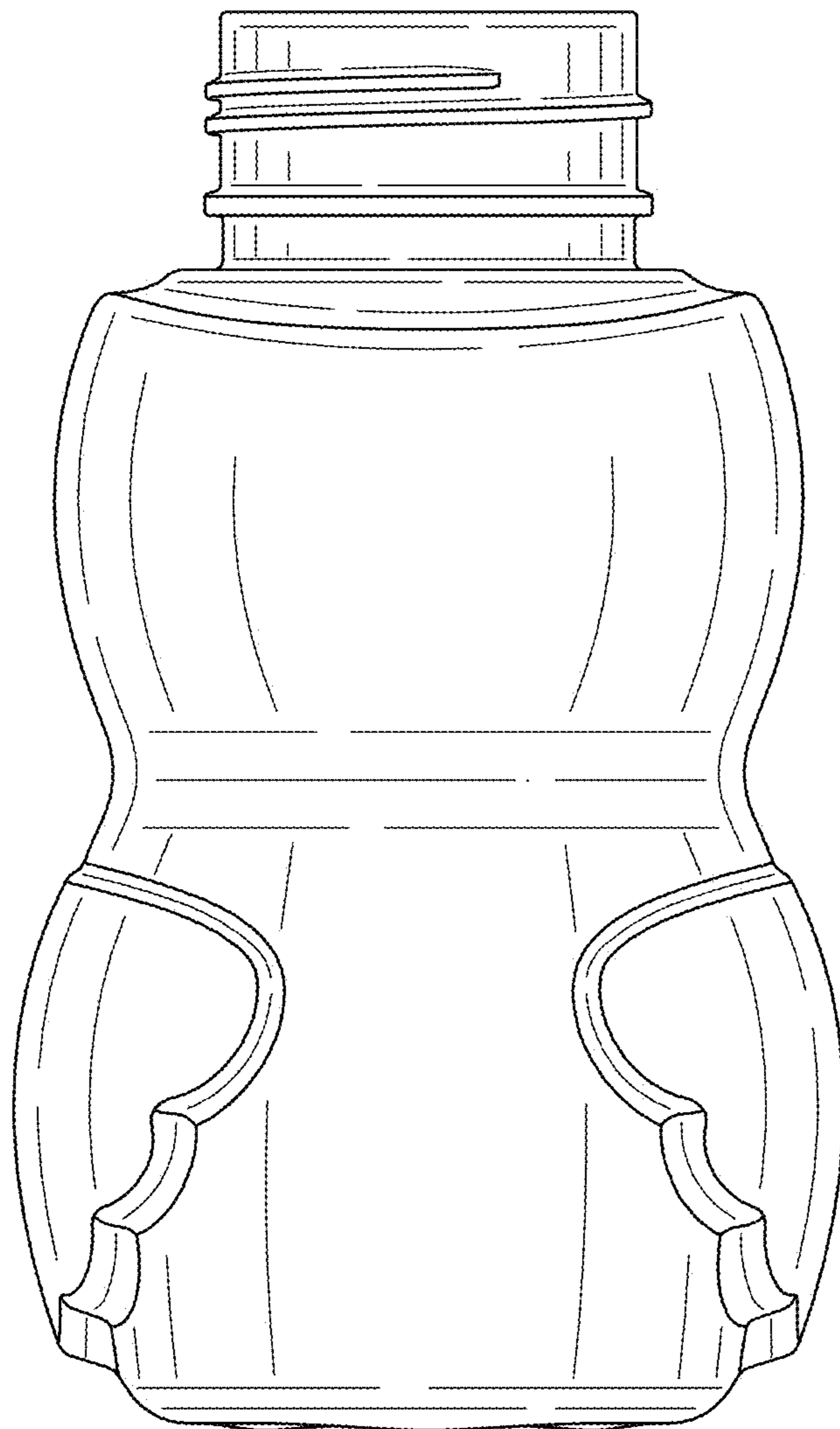

FIG. 4



*FIG. 5*

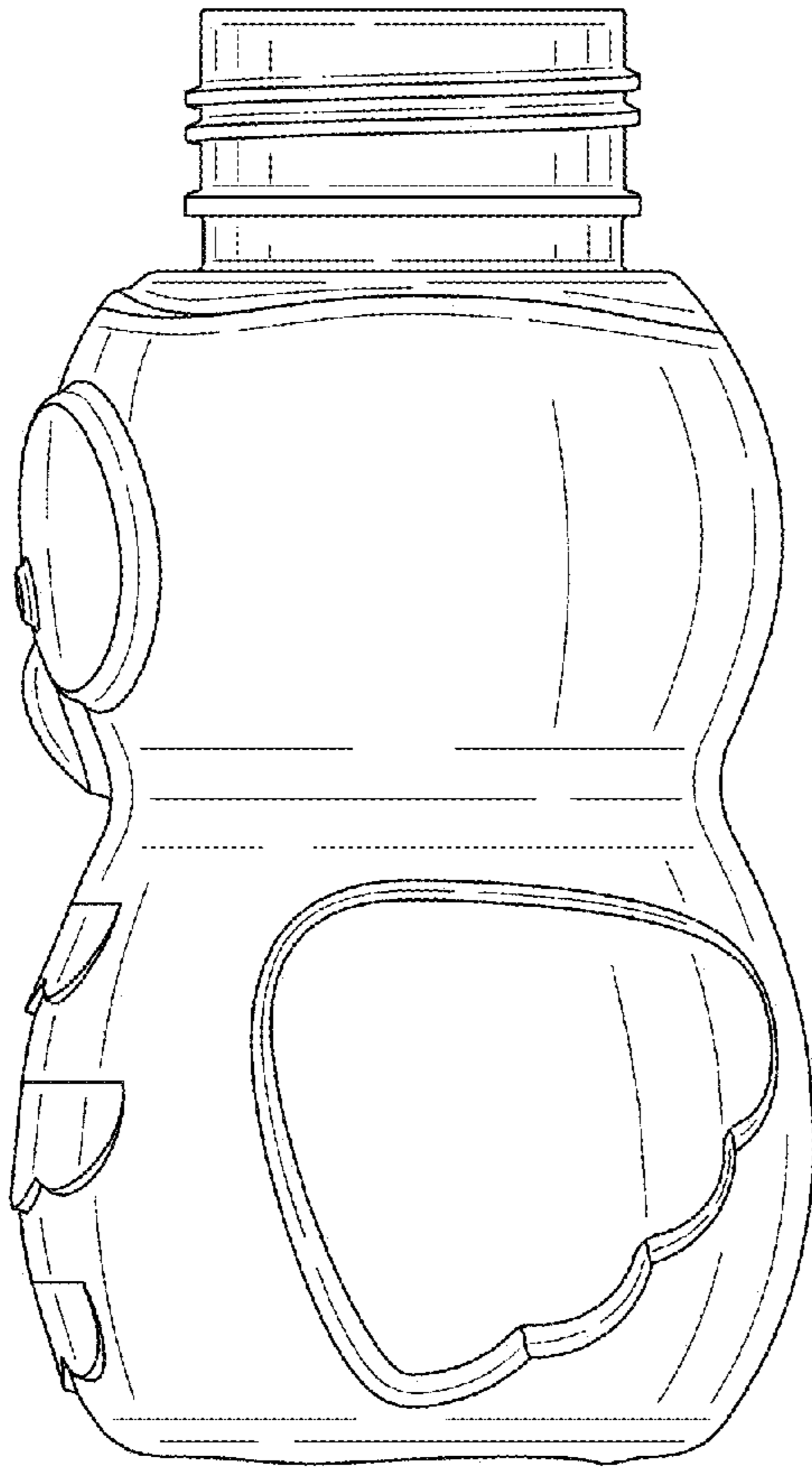

FIG. 6

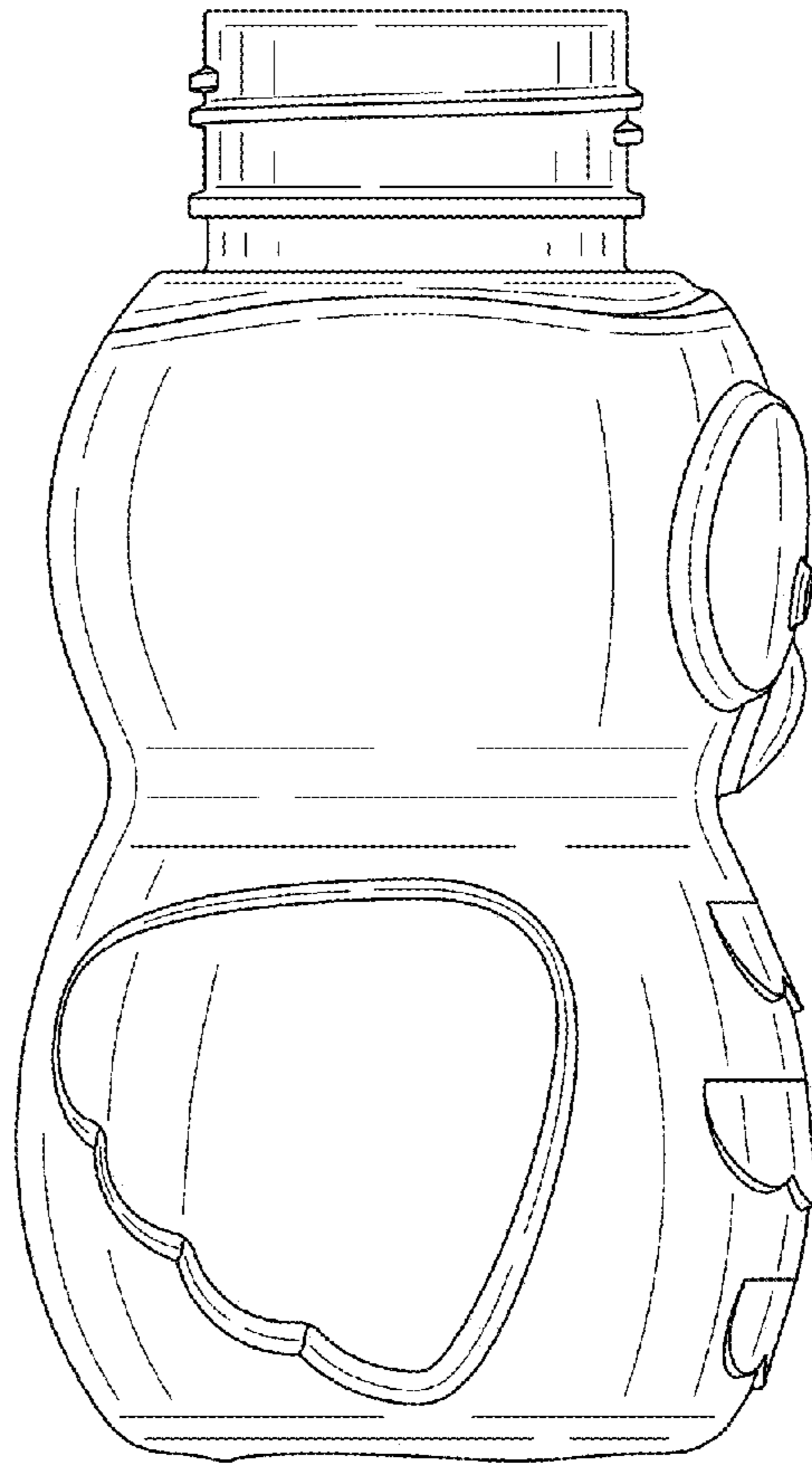

FIG. 7