



US00D766682S

(12) **United States Design Patent** (10) **Patent No.:** **US D766,682 S**
Flournoy (45) **Date of Patent:** **** Sep. 20, 2016**

(54) **TONGS**

(71) Applicant: **Ronald B. Flournoy**, Midlothian, VA (US)

(72) Inventor: **Ronald B. Flournoy**, Midlothian, VA (US)

(**) Term: **15 Years**

(21) Appl. No.: **29/534,479**

(22) Filed: **Jul. 29, 2015**

(51) **LOC (10) Cl.** **08-01**

(52) **U.S. Cl.**
USPC **D8/4**

(58) **Field of Classification Search**
USPC D8/1, 4, 13, 51, 55, 56; D7/683, 686, D7/687, 688
CPC A01D 7/00; A01D 7/10; A01D 9/06; A01D 11/06; A01B 1/00; A47J 43/283; A47J 43/28; A47J 43/00; F23J 1/04
See application file for complete search history.

(56) **References Cited**

U.S. PATENT DOCUMENTS

463,563	A *	11/1891	Williamson	A47J 43/283 294/3
1,723,597	A *	8/1929	Bannister	B25B 9/00 294/106
2,751,245	A *	6/1956	Boyd	F23J 1/04 294/11
4,953,347	A *	9/1990	Siegfried	A01B 1/00 294/50.8
4,991,386	A *	2/1991	Dirksen	A01D 7/10 294/50.8
D359,207	S *	6/1995	Meiller	D8/13
D384,865	S *	10/1997	Baran	294/50.8
D506,112	S *	6/2005	Roberson	D8/13
D634,593	S *	3/2011	Kavanagh	D8/4
2014/0110957	A1 *	4/2014	Torres, Jr.	A47G 21/10 294/106

* cited by examiner

Primary Examiner — Ian Simmons

Assistant Examiner — Ieisha Price

(74) *Attorney, Agent, or Firm* — Brian J. Teague

(57) **CLAIM**

I claim the ornamental design for a tongs, as shown and described.

DESCRIPTION

FIG. 1 is a perspective view of a tongs, showing the new design.
 FIG. 2 is a front view thereof.
 FIG. 3 is a rear view thereof.
 FIG. 4 is a left side view thereof.
 FIG. 5 is a right side view thereof.
 FIG. 6 is a top view thereof.
 FIG. 7 is a bottom view thereof.
 FIG. 8 is a front view thereof, with the 7-tooth portion removed for clarity.
 FIG. 9 is a rear view thereof, with the 6-tooth portion removed for clarity.
 FIG. 10 is a front view of an alternative embodiment of a tongs.
 FIG. 11 is a rear view thereof.
 FIG. 12 is a left side view thereof.
 FIG. 13 is a right side view thereof.
 FIG. 14 is a top view thereof.
 FIG. 15 is a bottom view thereof.
 FIG. 16 is a front view thereof, with the 7-tooth portion removed for clarity; and,
 FIG. 17 is a rear view thereof, with the 6-tooth portion removed for clarity.
 The broken lines in the drawings illustrate portions of the tongs and form no part of the claimed design.

1 Claim, 17 Drawing Sheets

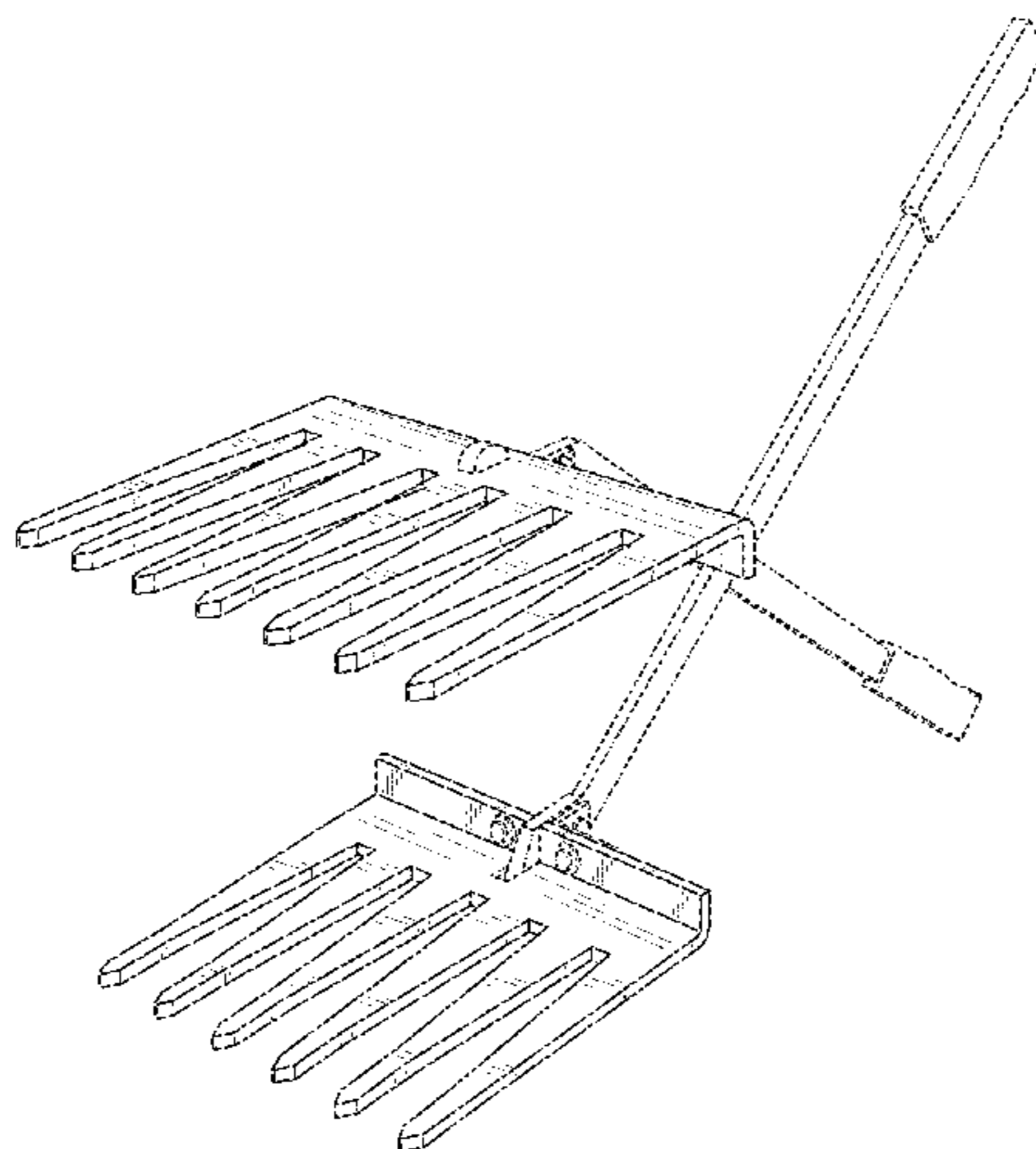

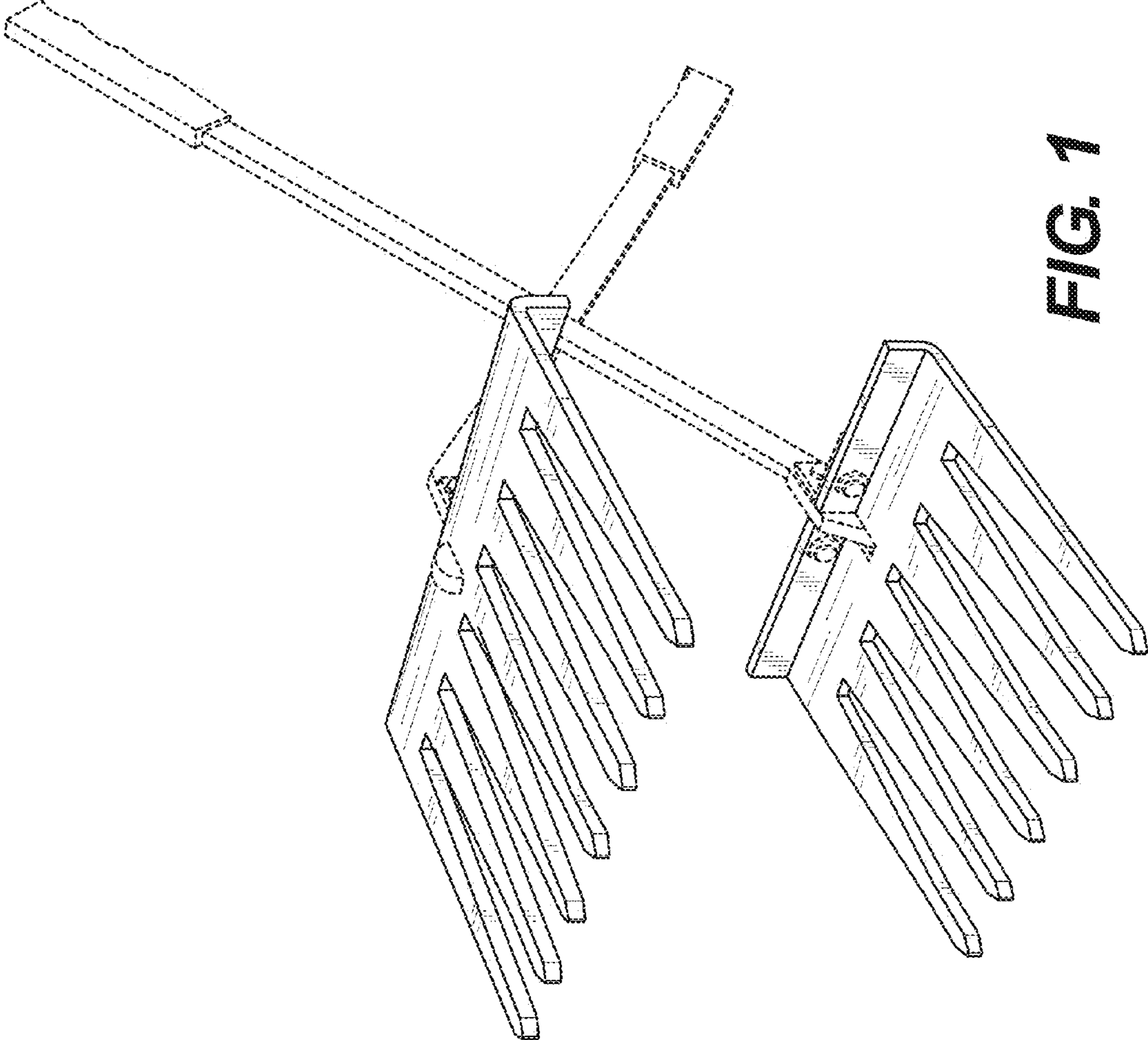

FIG. 1

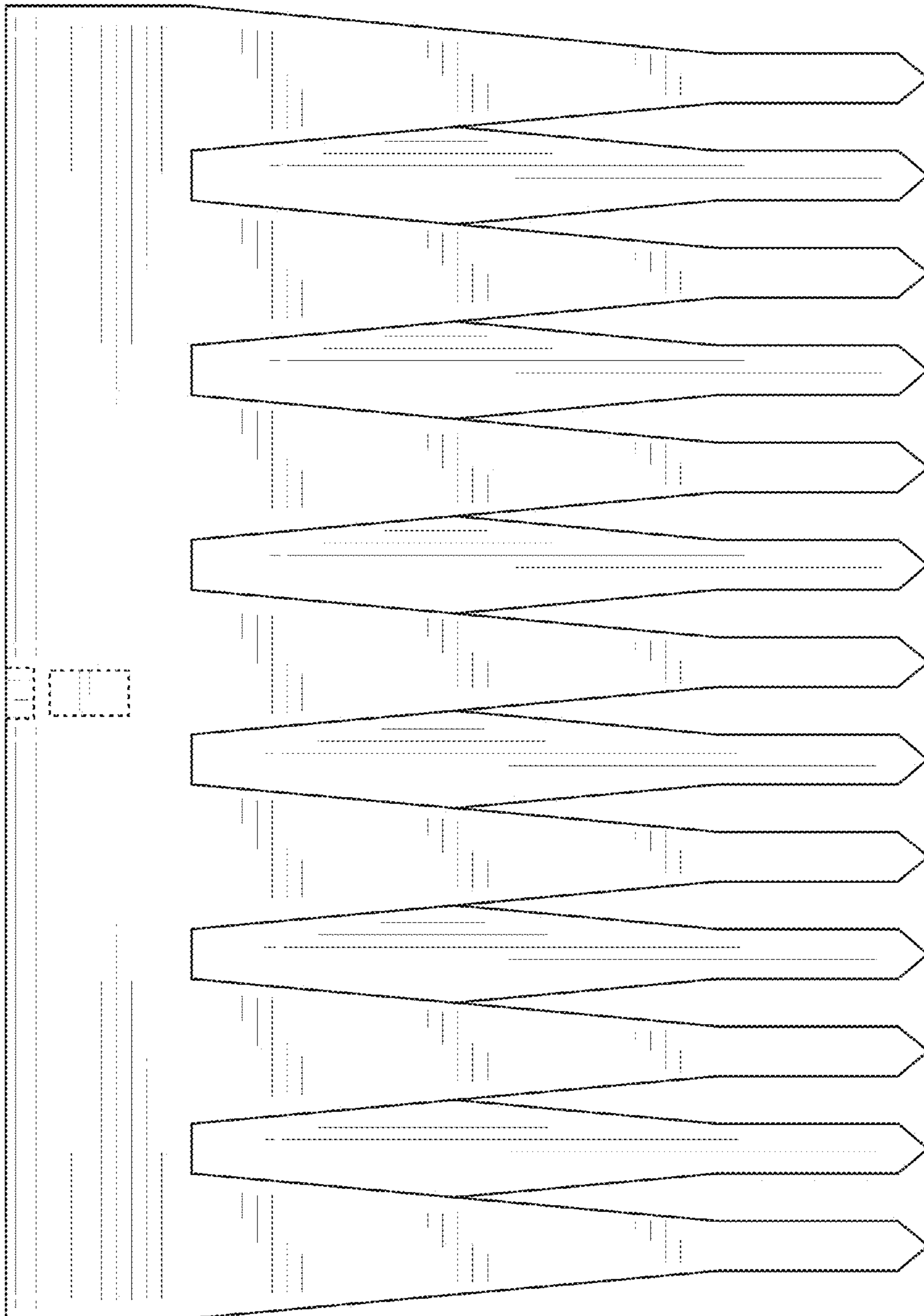

FIG. 2

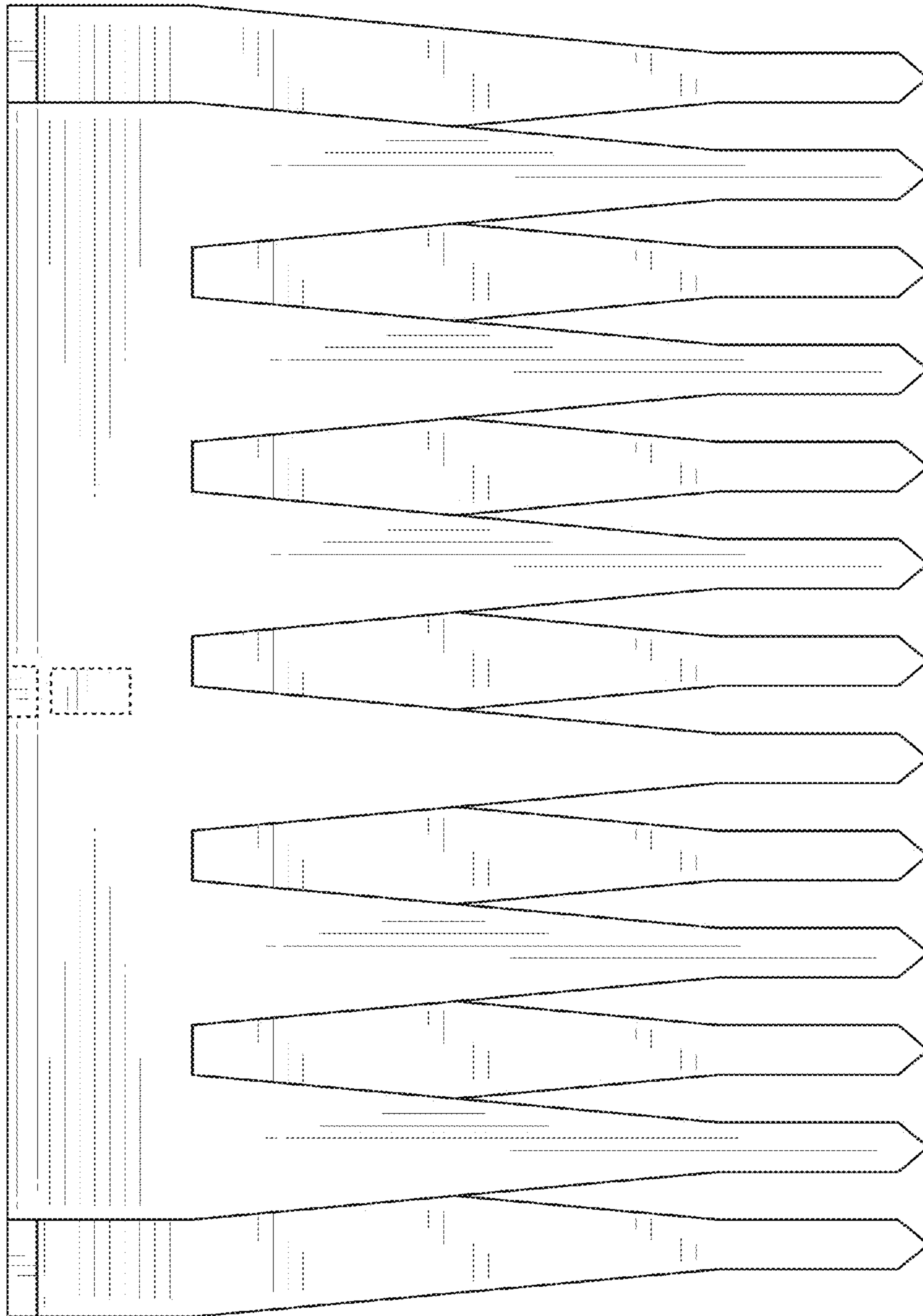

FIG. 3

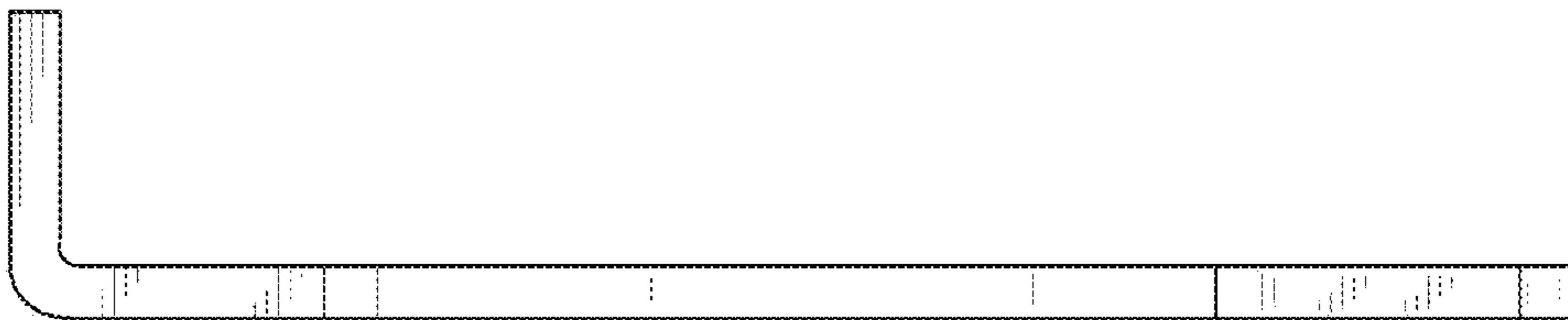
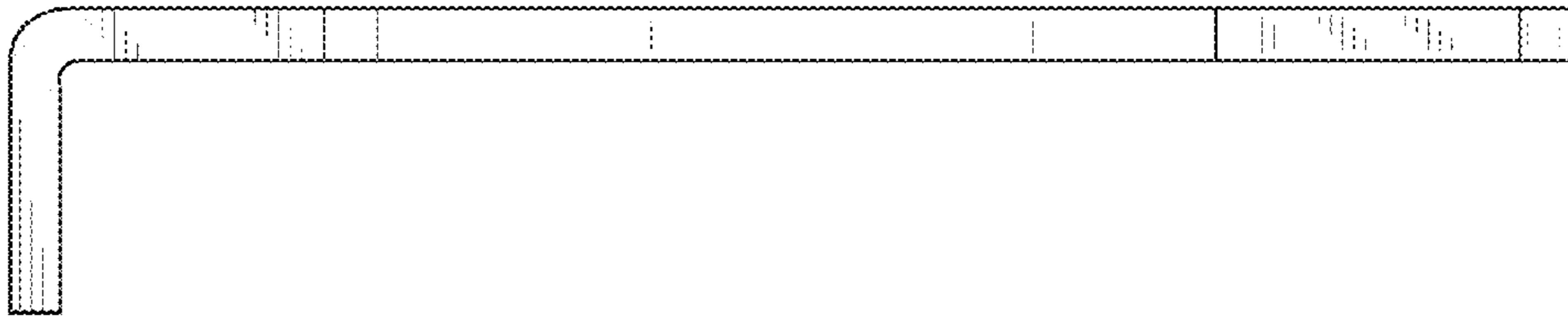

FIG. 4

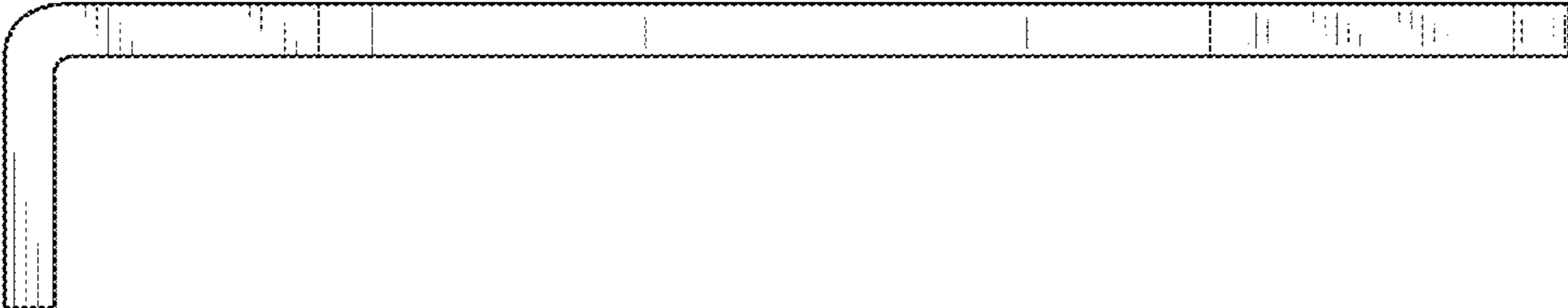
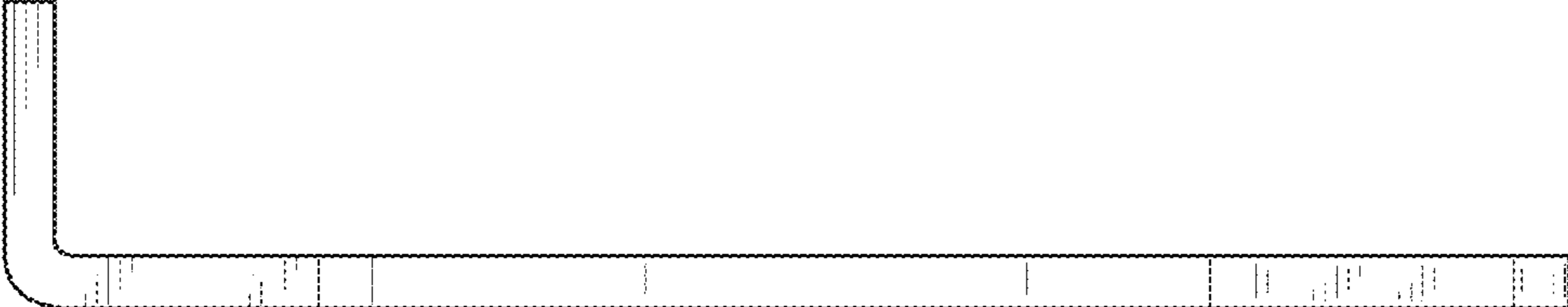

FIG. 5



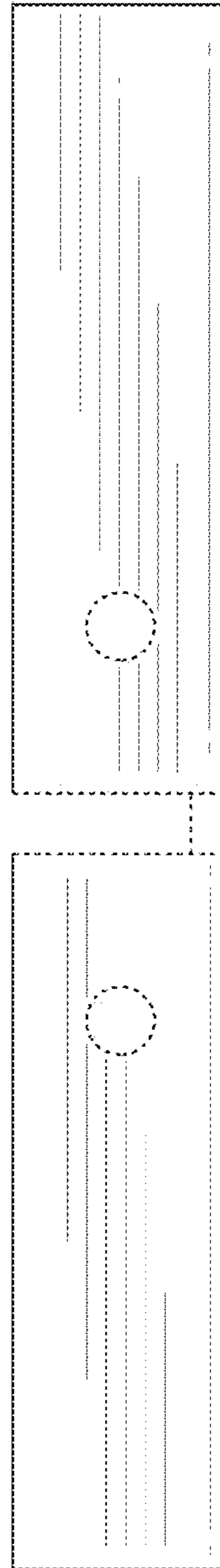
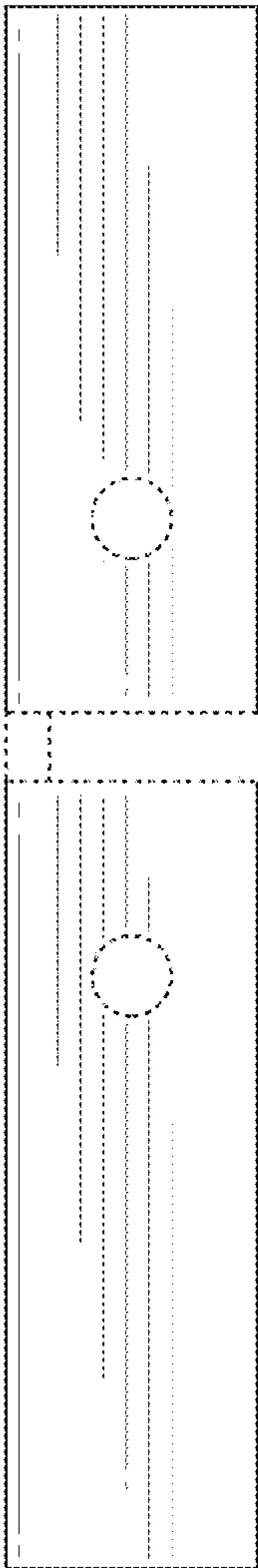

FIG. 6

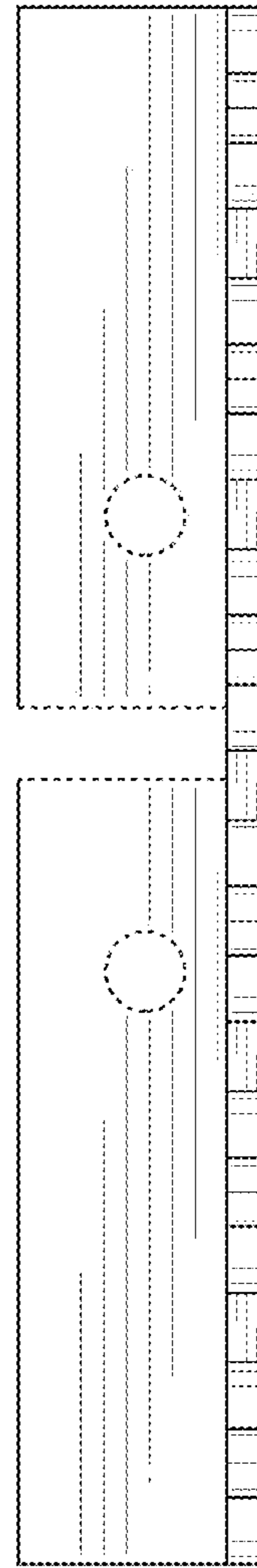
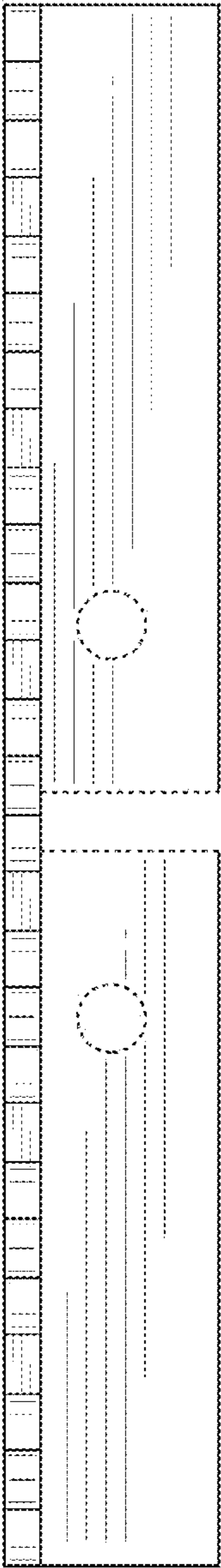

FIG. 7

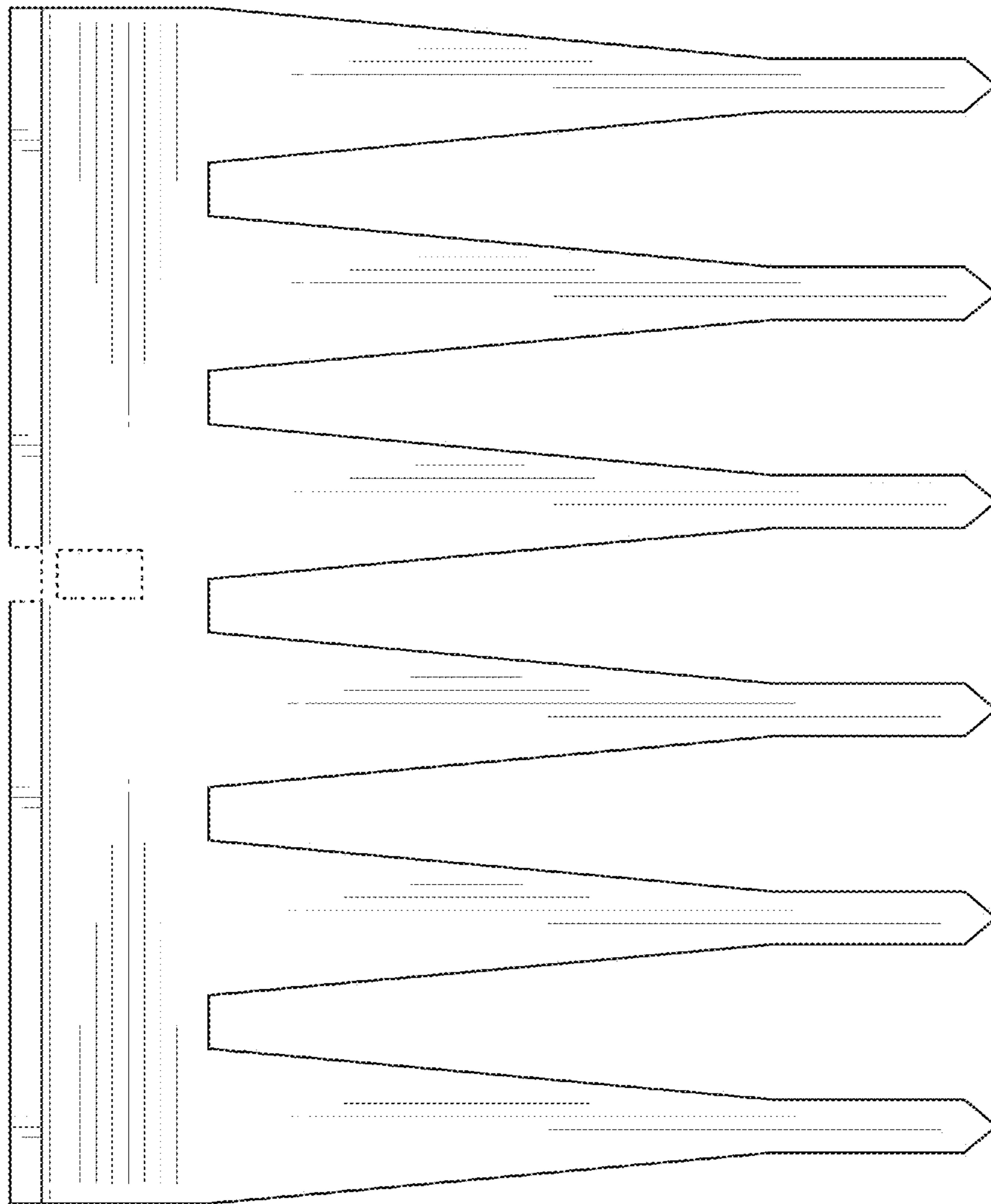

FIG. 8

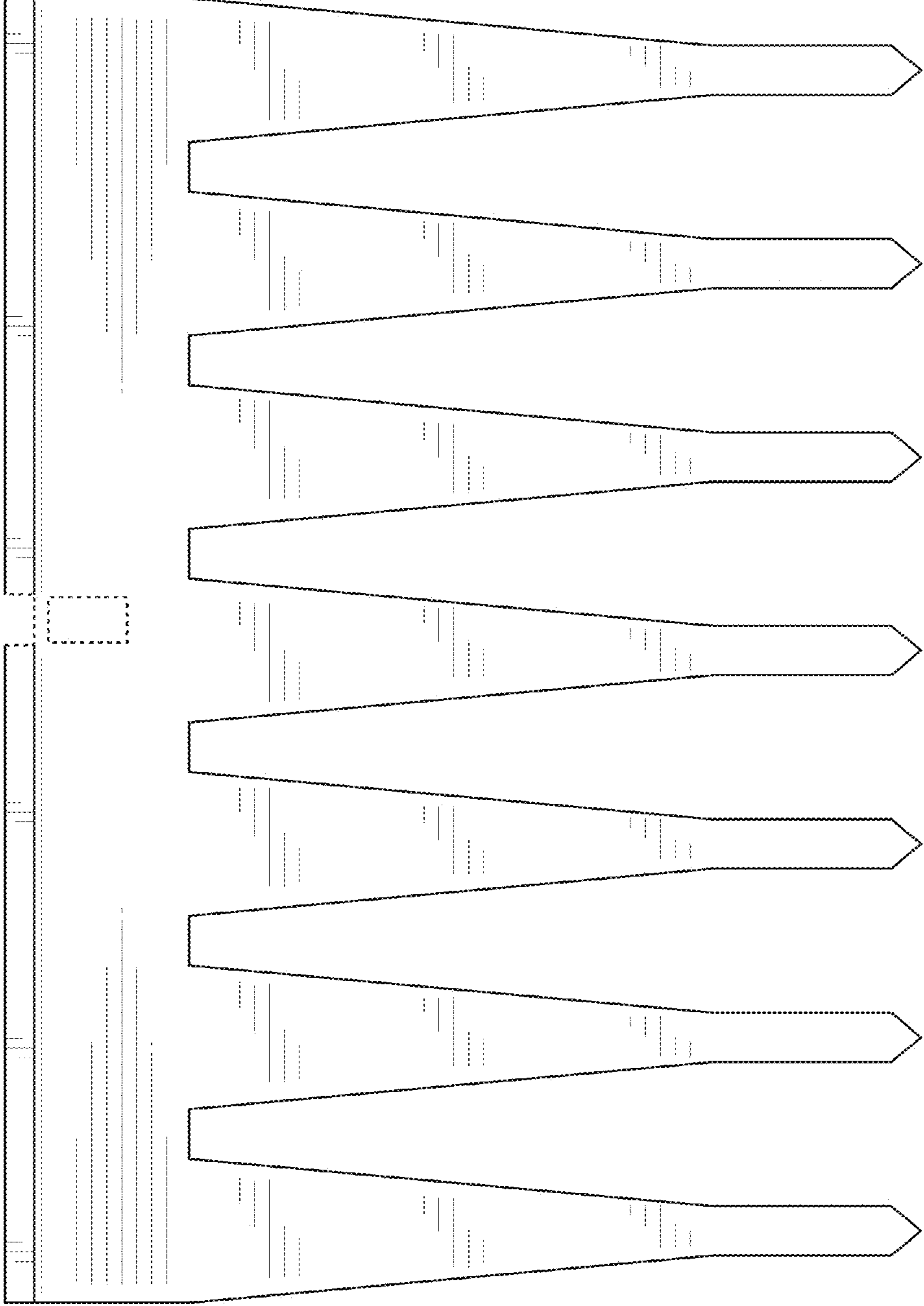

FIG. 9

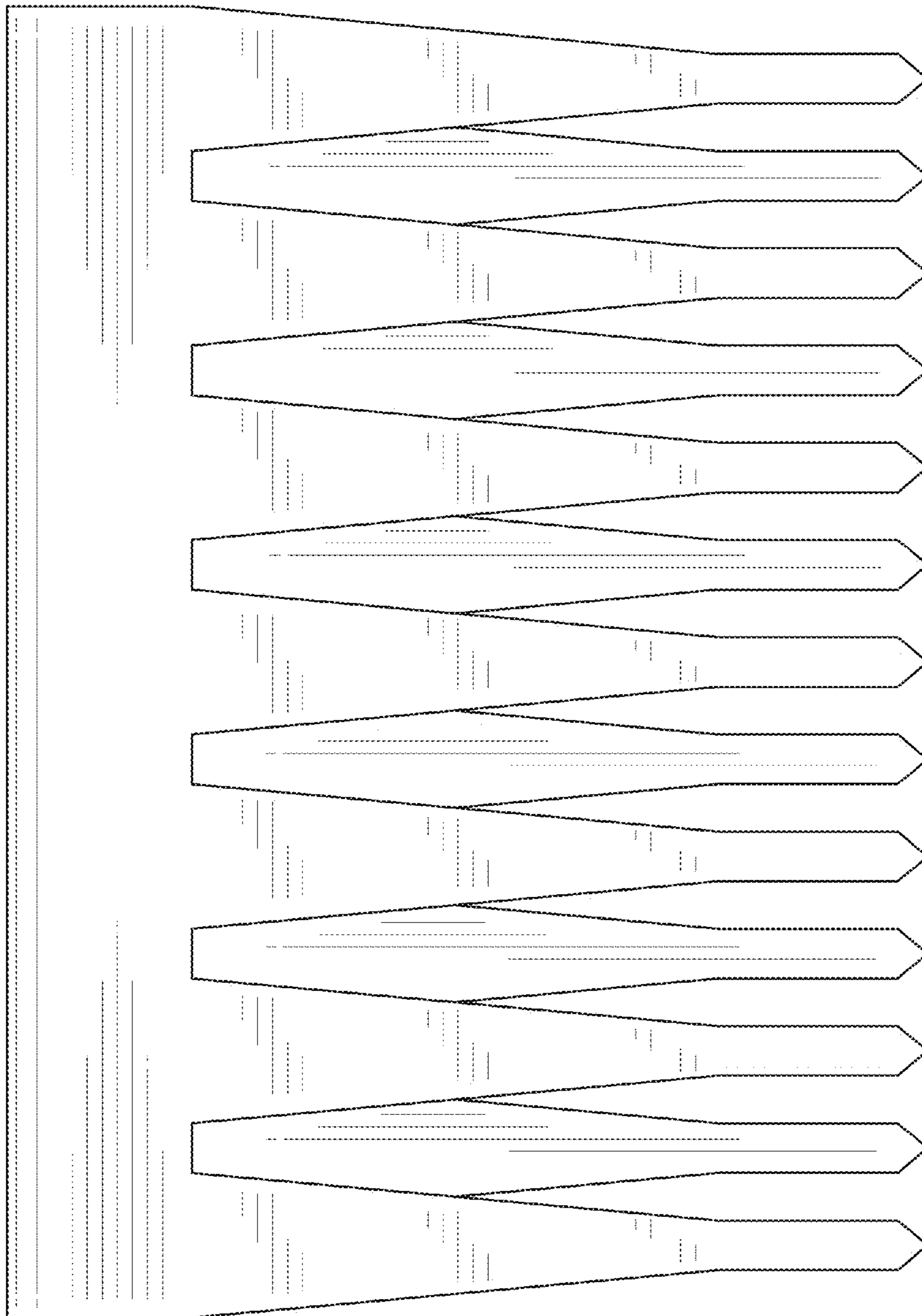

FIG. 10

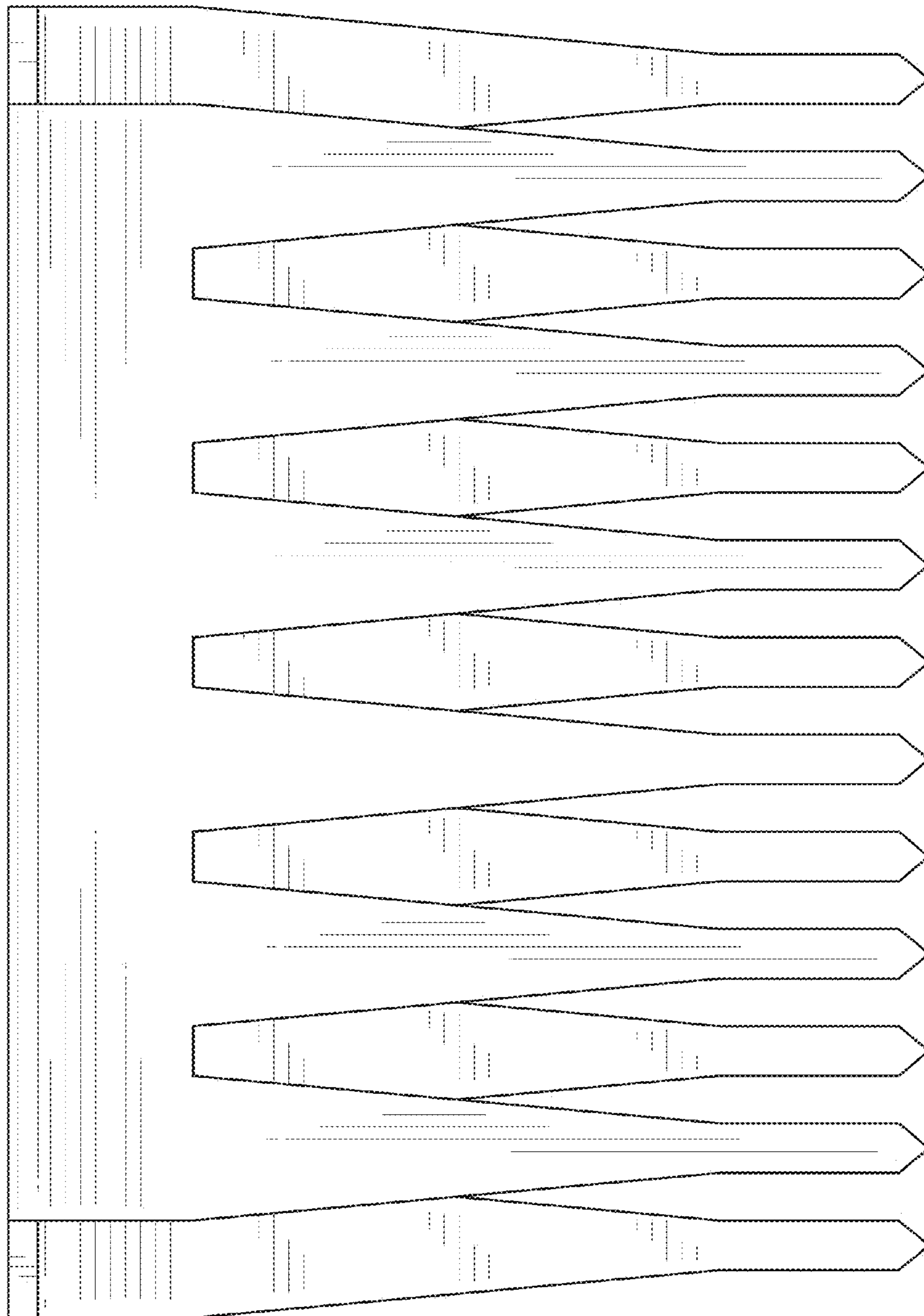

FIG. 11

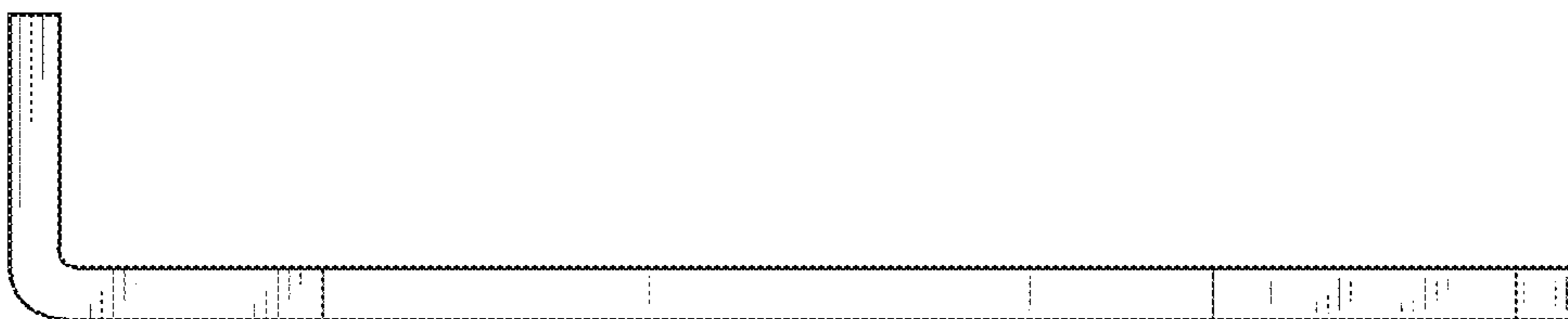
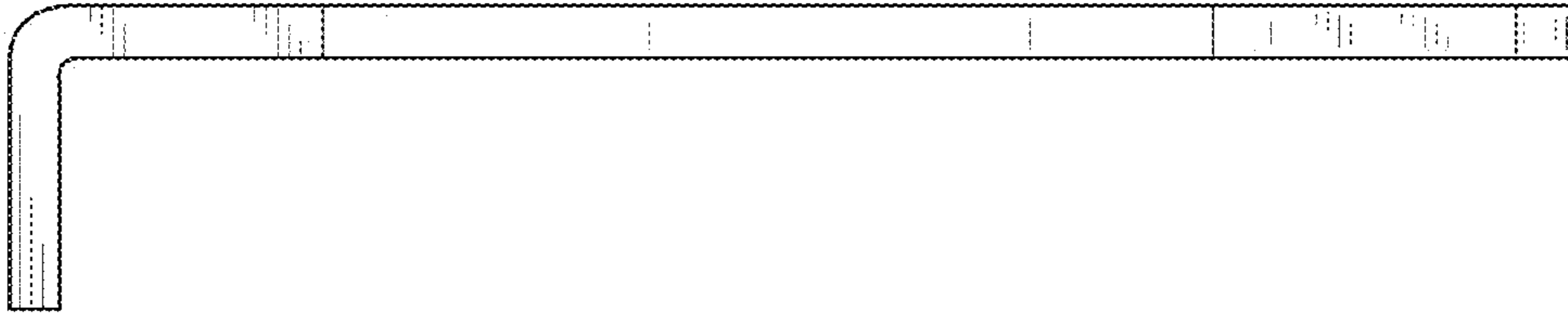

FIG. 12

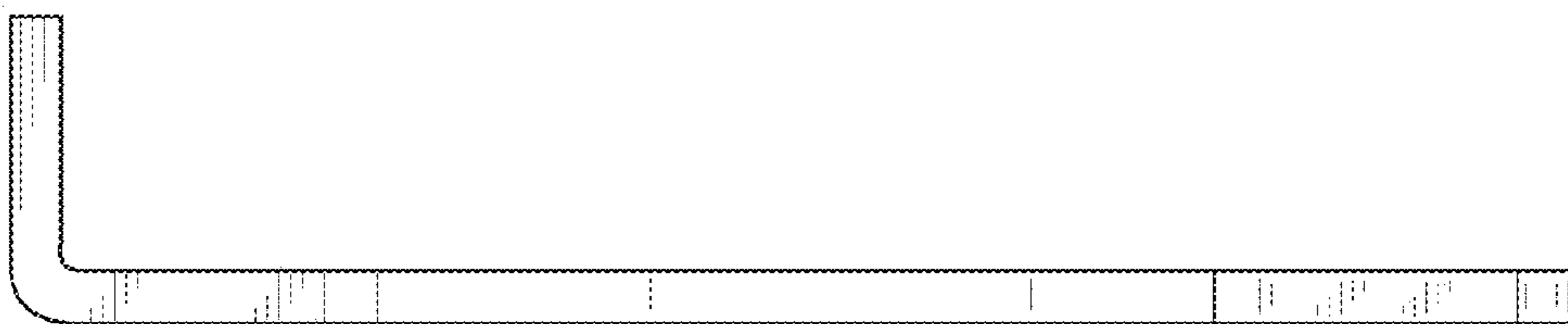
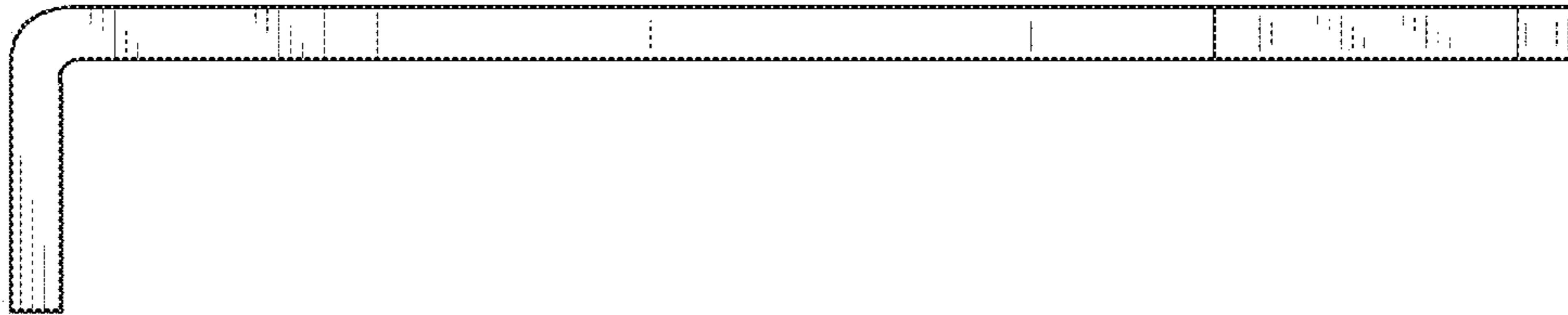

FIG. 13

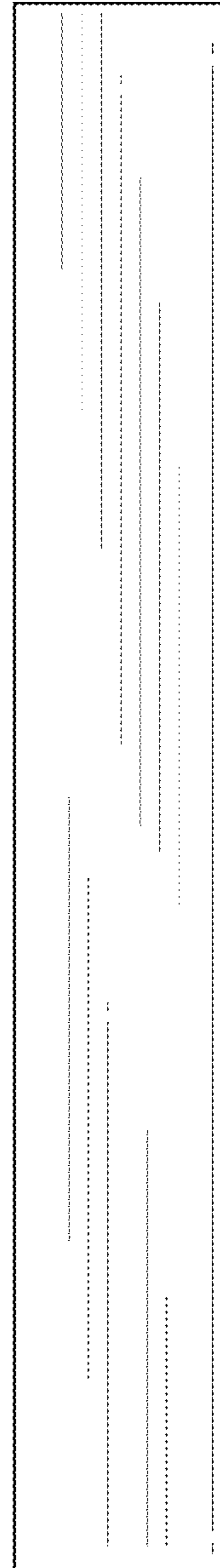
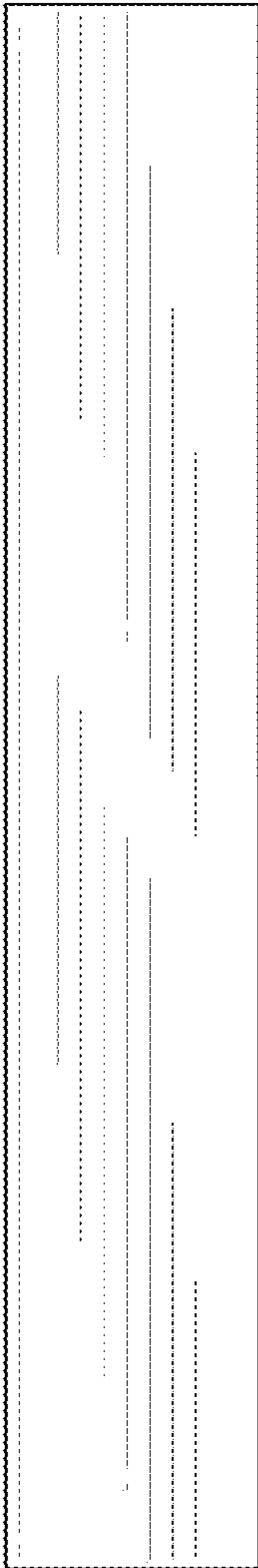

FIG. 14

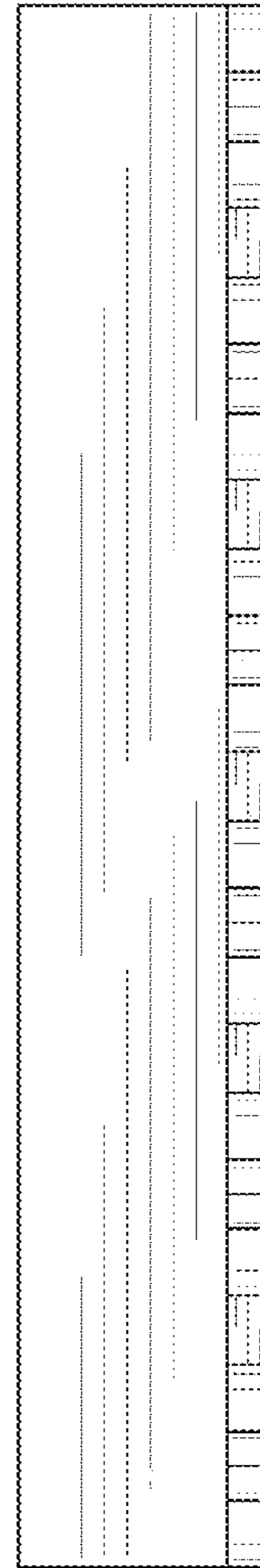
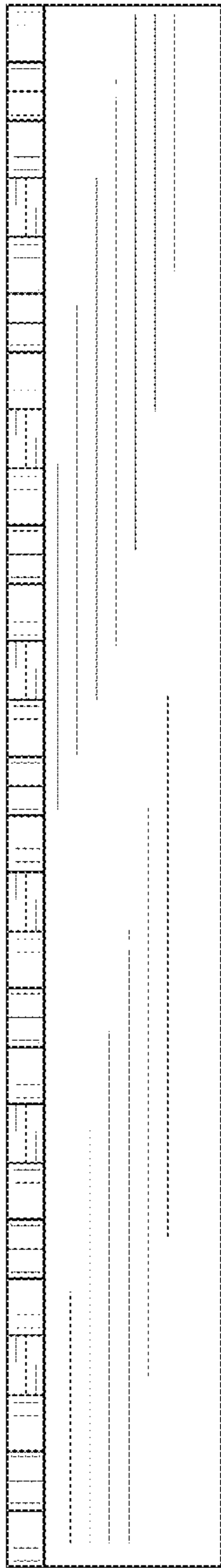

FIG. 15

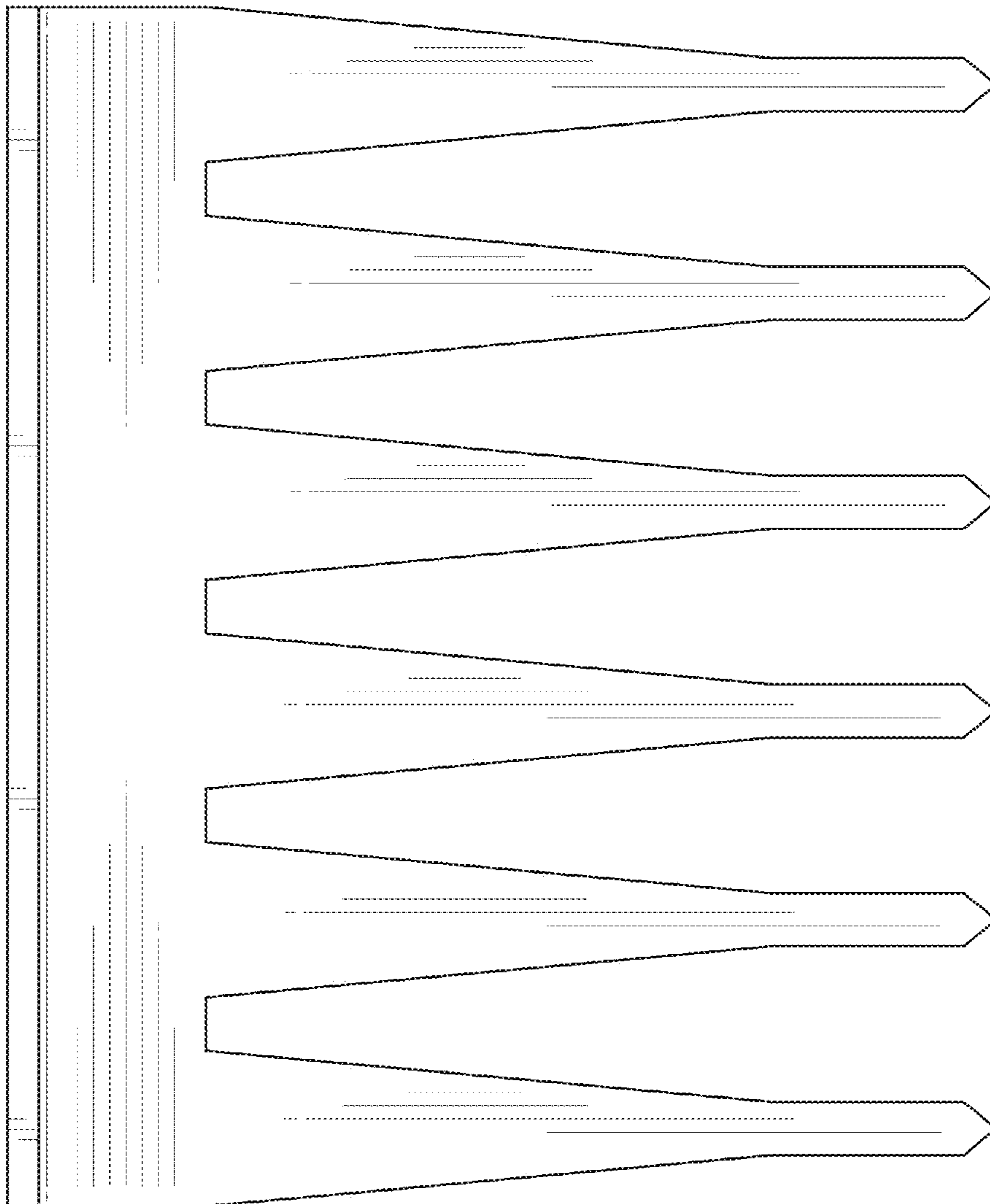

FIG. 16

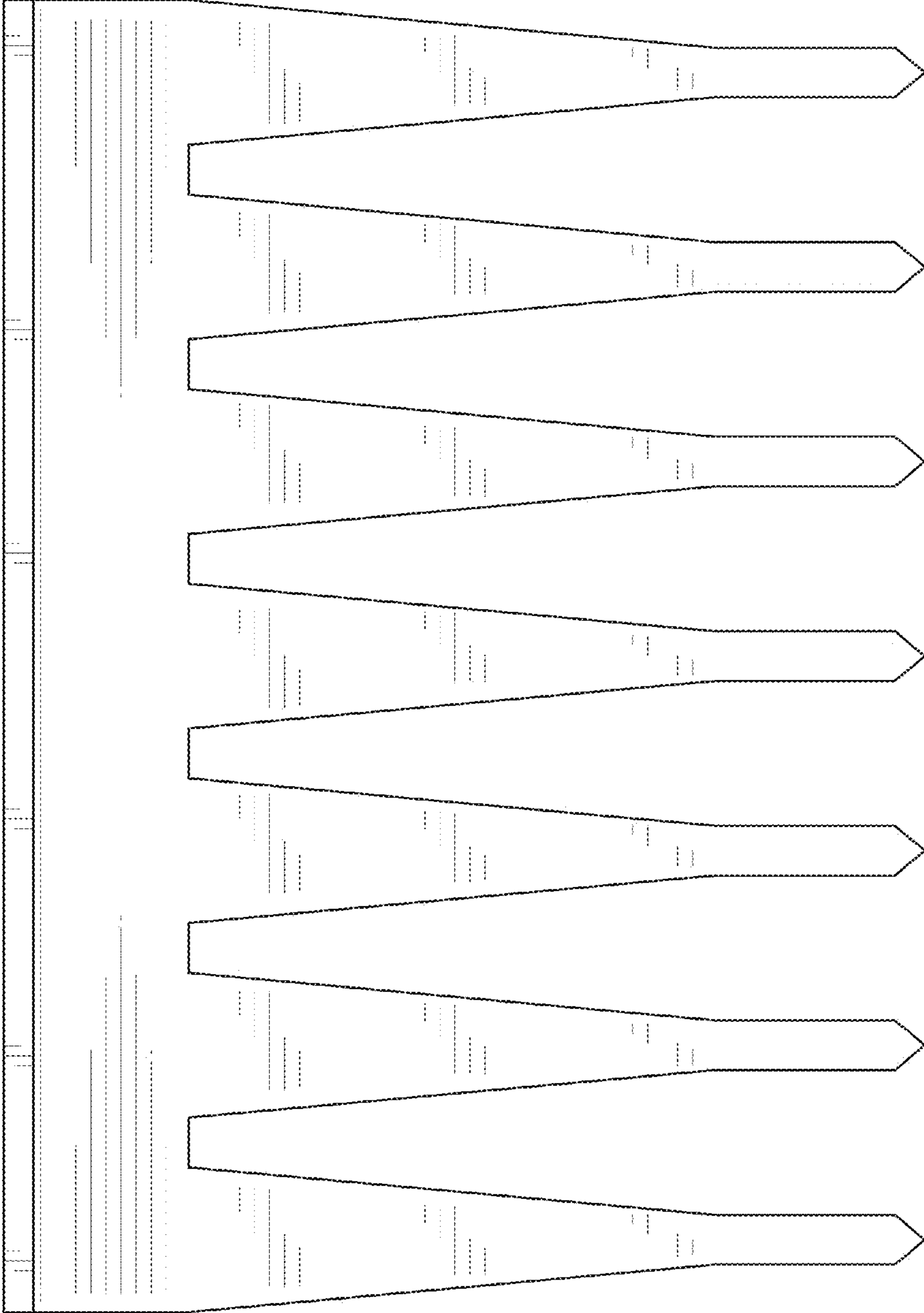

FIG. 17