



US00D766681S

(12) **United States Design Patent** (10) **Patent No.:** **US D766,681 S**
Hartshorn et al. (45) **Date of Patent:** **** Sep. 20, 2016**

(54) **Y-PEELER**
(71) Applicant: **JOSEPH JOSEPH LTD**, London (GB)
(72) Inventors: **Richard Hartshorn**, London (GB);
Edward Goodwin, London (GB)
(73) Assignee: **Joseph Joseph Ltd.**, London (GB)
(**) Term: **14 Years**
(21) Appl. No.: **29/517,451**
(22) Filed: **Feb. 12, 2015**

(30) **Foreign Application Priority Data**
Oct. 2, 2014 (EM) 002549576-0002
(51) **LOC (10) Cl.** **07-04**
(52) **U.S. Cl.**
USPC **D7/695**
(58) **Field of Classification Search**
USPC D7/680-697, 393, 395
CPC A47J 17/02; A47J 17/00; A47J 17/04;
A47J 17/08; B26B 5/00
See application file for complete search history.

(56) **References Cited**
U.S. PATENT DOCUMENTS
D407,277 S * 3/1999 Cousins D7/695
D674,254 S * 1/2013 Spiegel D7/695
D675,890 S * 2/2013 Reay D7/695
2009/0235830 A1 * 9/2009 Rasa A47J 17/02
99/588

* cited by examiner

Primary Examiner — Terry Wallace
(74) *Attorney, Agent, or Firm* — Millen White Zelano & Branigan, P.C.

(57) **CLAIM**
The ornamental design for a Y peeler, as shown and described.

DESCRIPTION

FIG. 1 is a perspective view of the straight peeler showing my new design.
FIG. 2 is a front view thereof.
FIG. 3 is a rear view thereof.
FIG. 4 is a side view thereof.
FIG. 5 is an opposite side view thereof.
FIG. 6 is a bottom view thereof.
FIG. 7 is a top view thereof.
FIG. 8 is a perspective view of an alternate embodiment of FIG. 1.
FIG. 9 is a front view of FIG. 8.
FIG. 10 is a rear view of FIG. 8.
FIG. 11 is a side view of FIG. 8.
FIG. 12 is an opposite side view of FIG. 8.
FIG. 13 is a bottom view of FIG. 8; and,
FIG. 14 is a top view of FIG. 8.
The broken lines showing parts of the straight peeler are shown for illustrative purposes only and form no part of the claimed design.

1 Claim, 14 Drawing Sheets

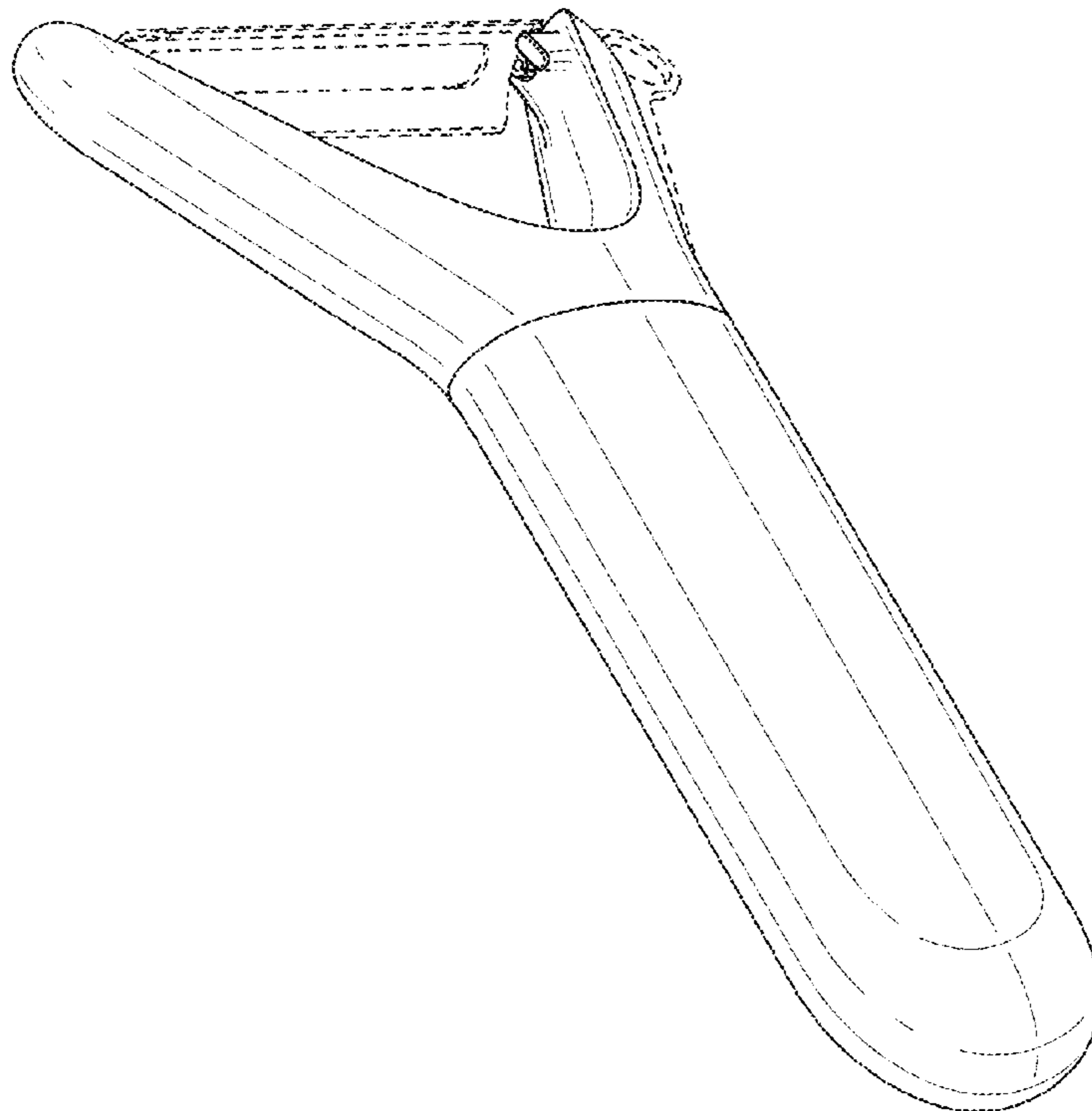

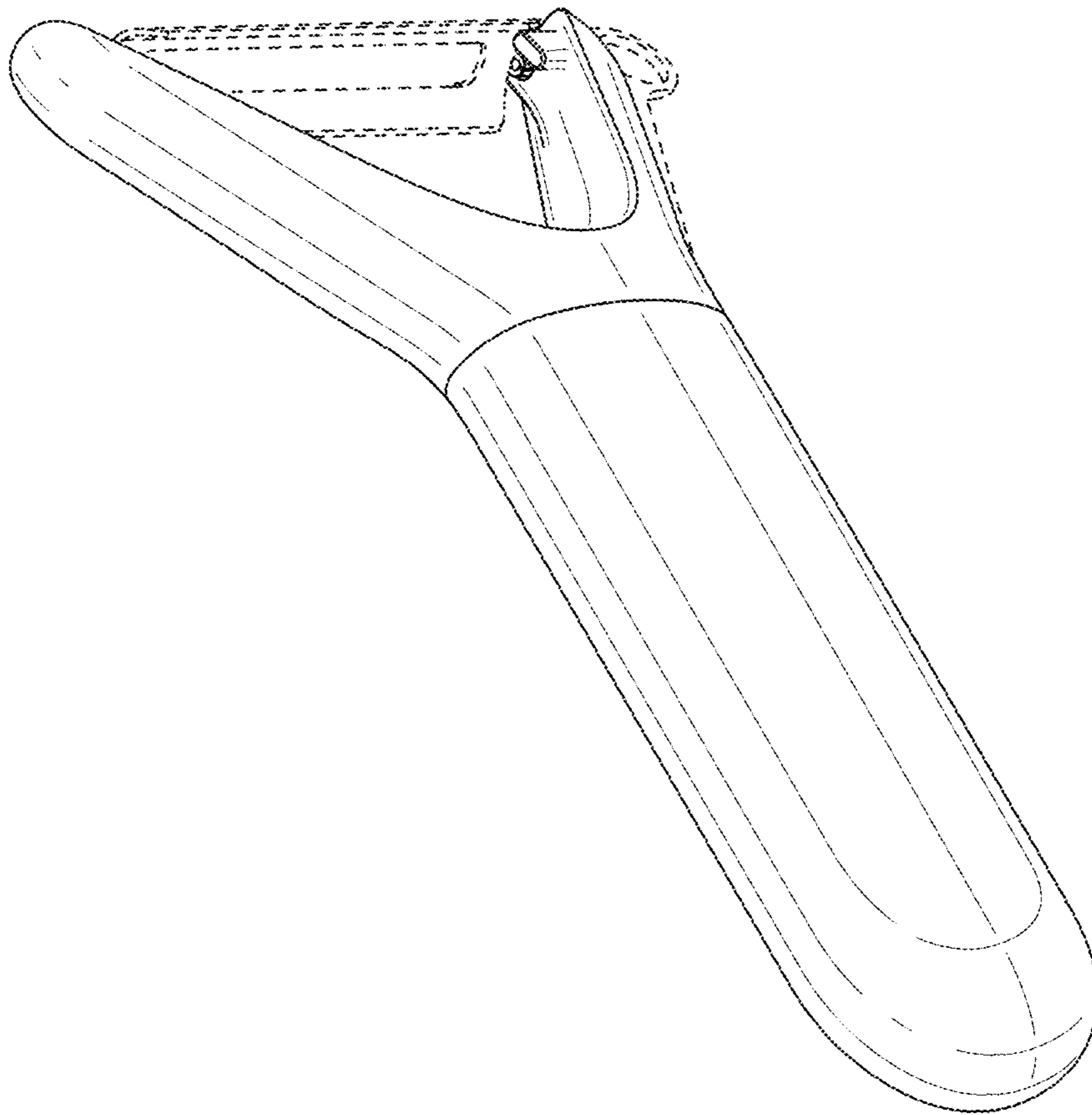

FIG.1

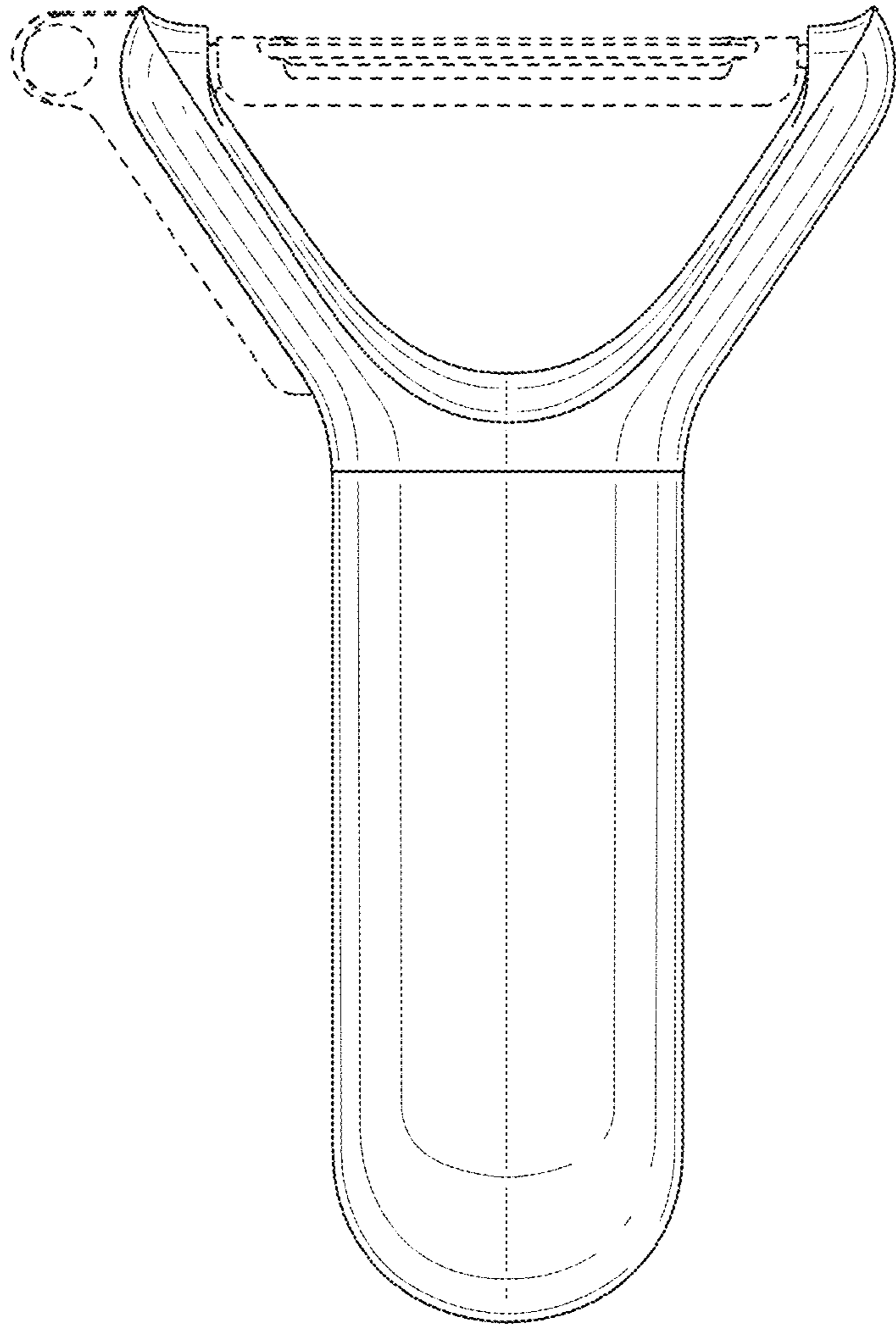

FIG.2

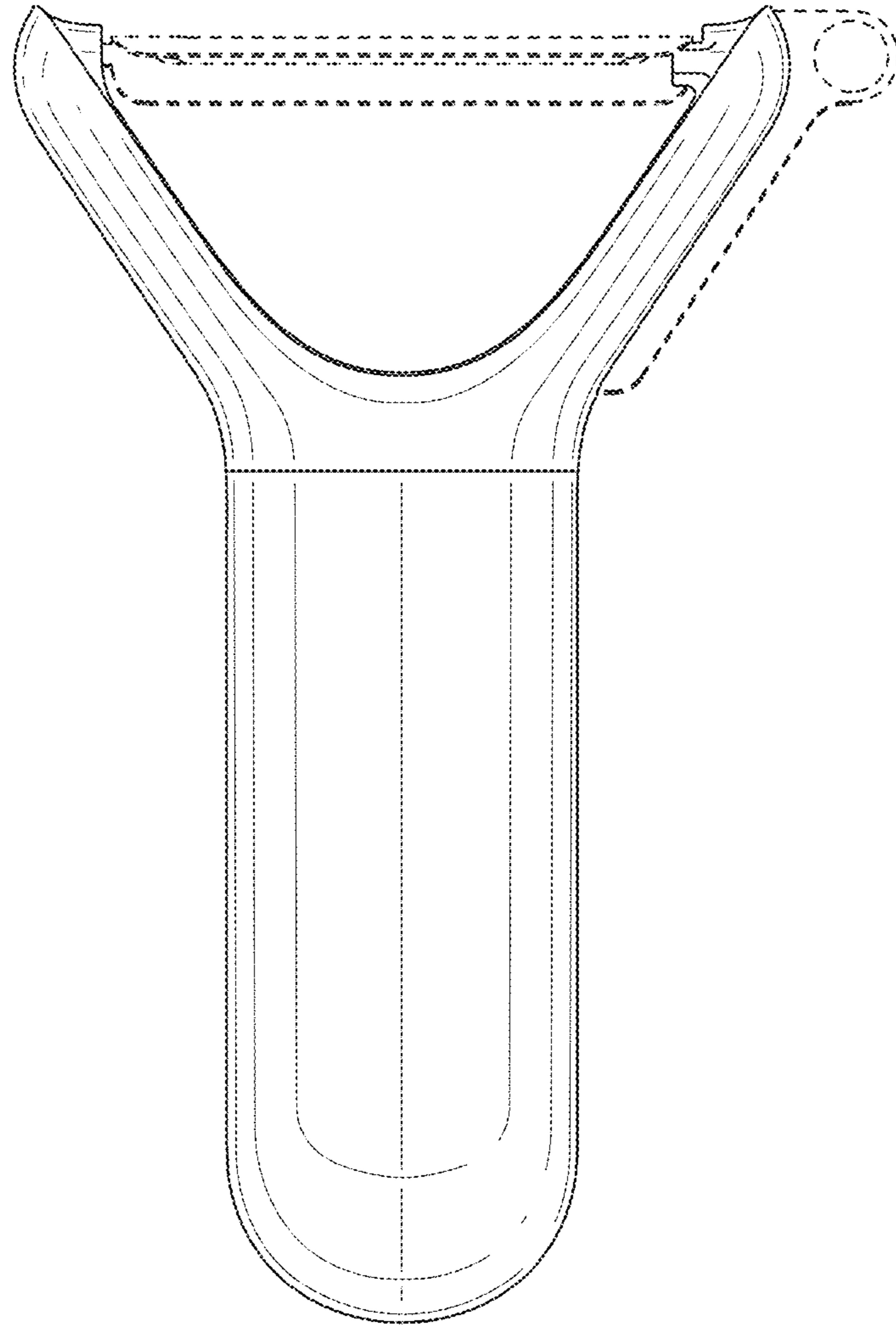

FIG.3

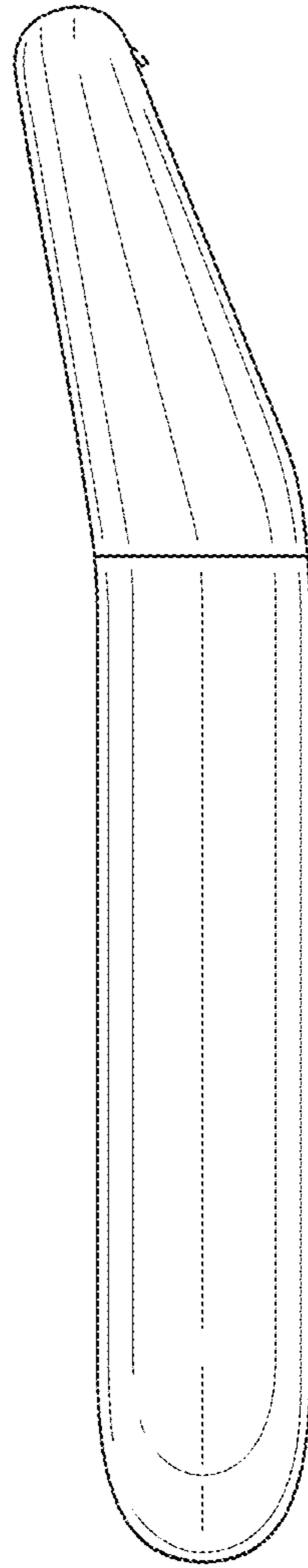

FIG.4

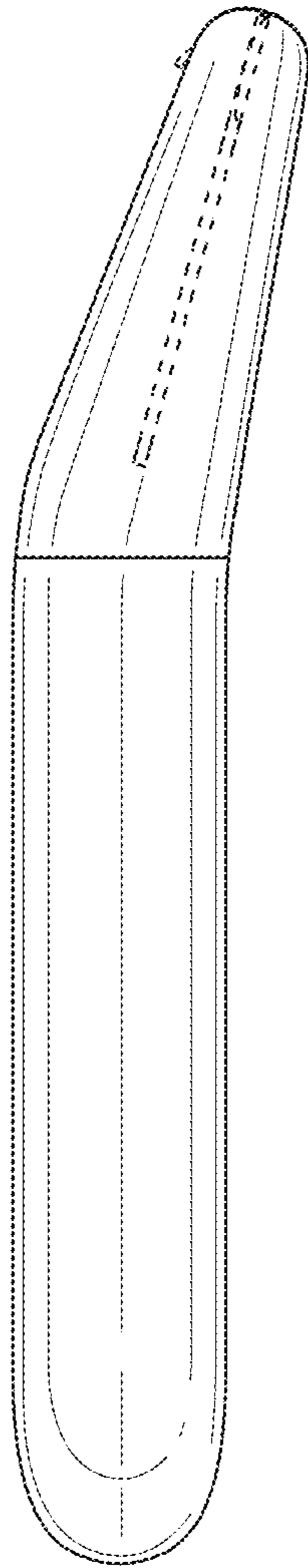

FIG.5

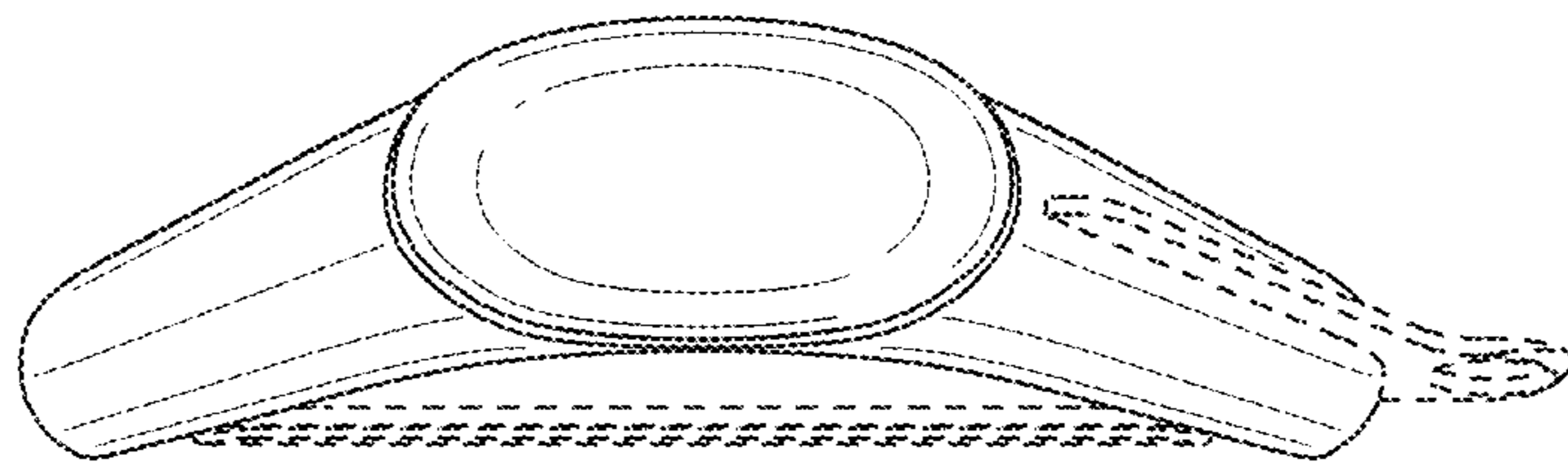

FIG. 6

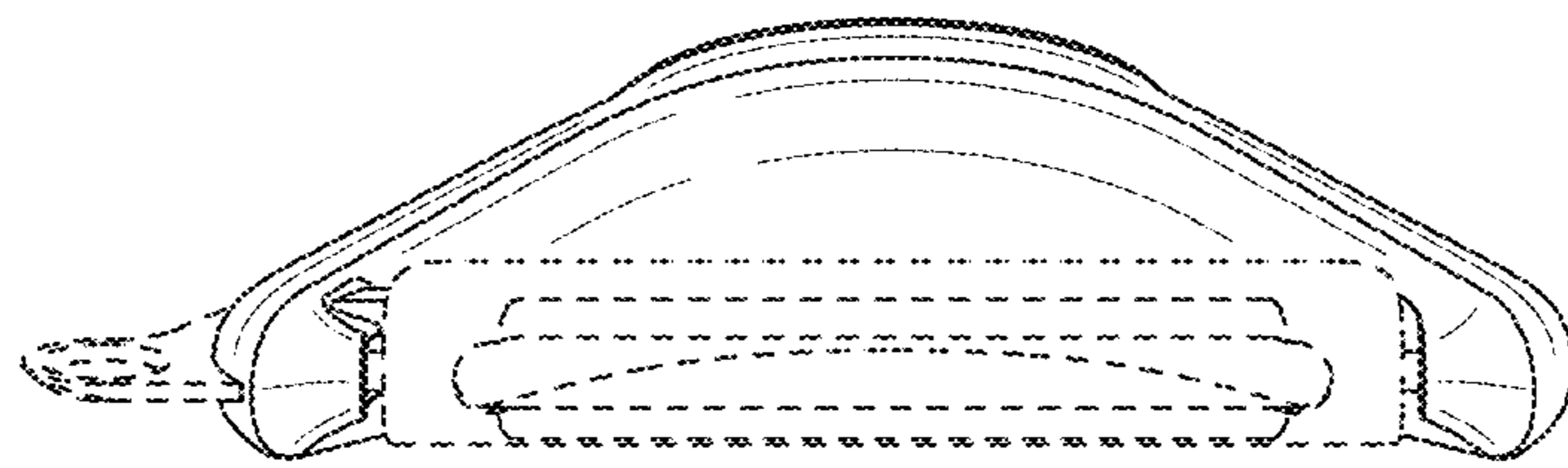

FIG.7

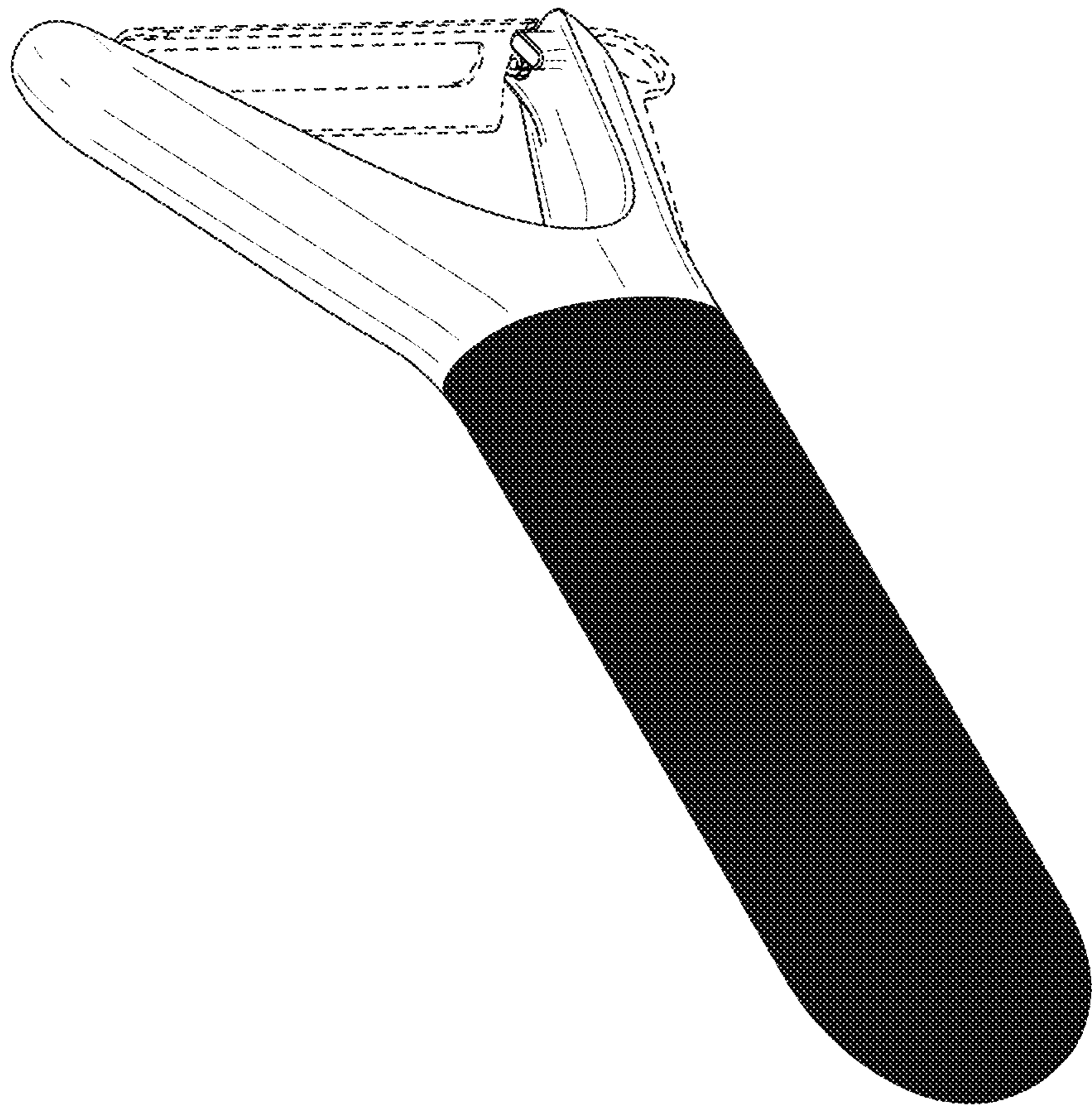

FIG. 8

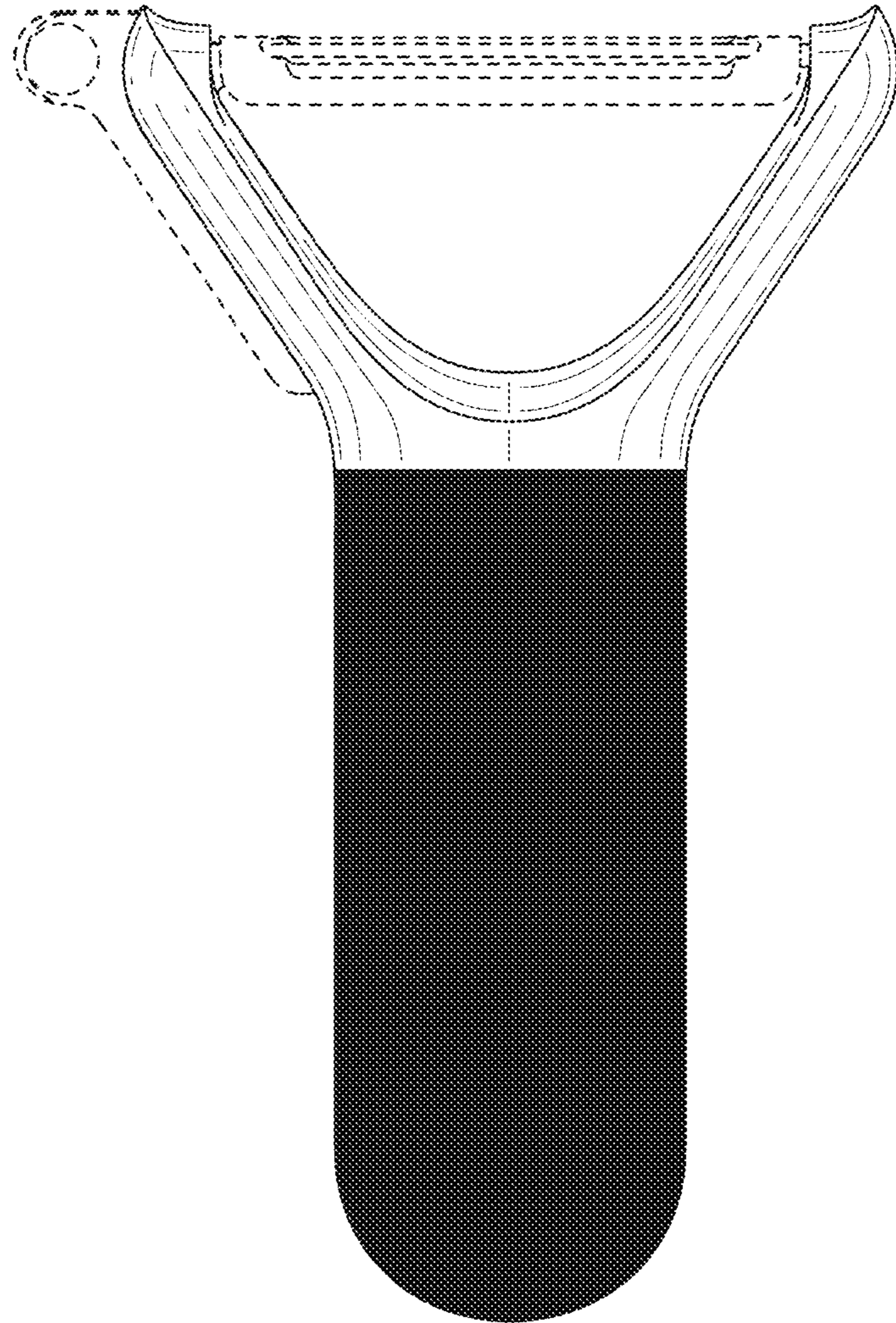

FIG. 9

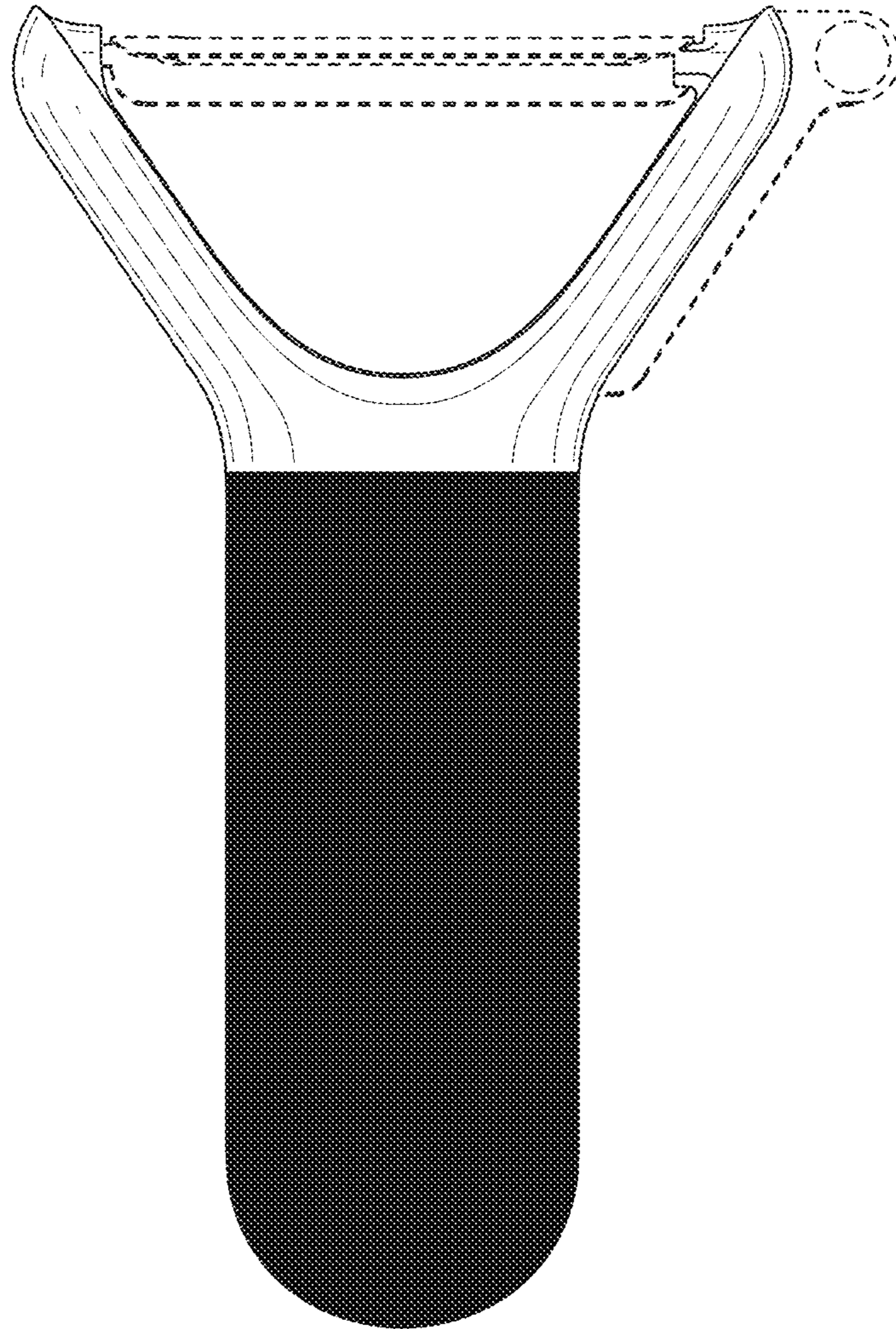

FIG. 10

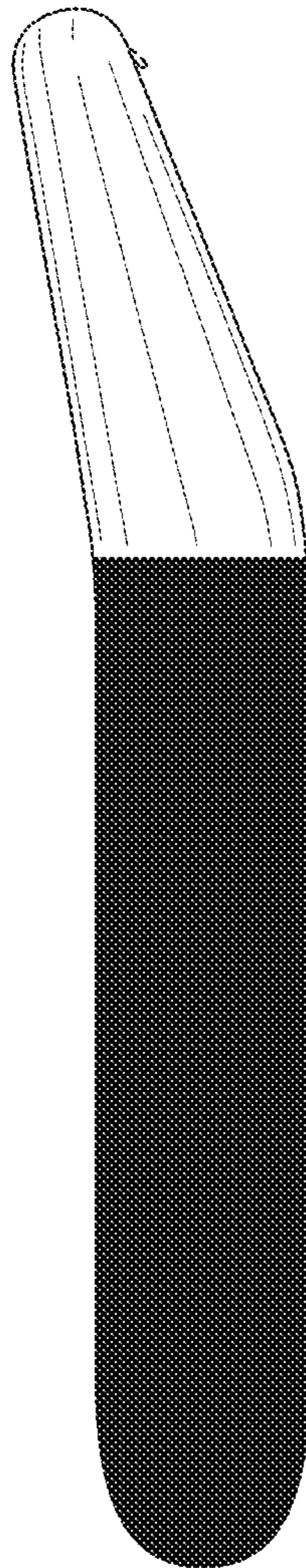

FIG. 11

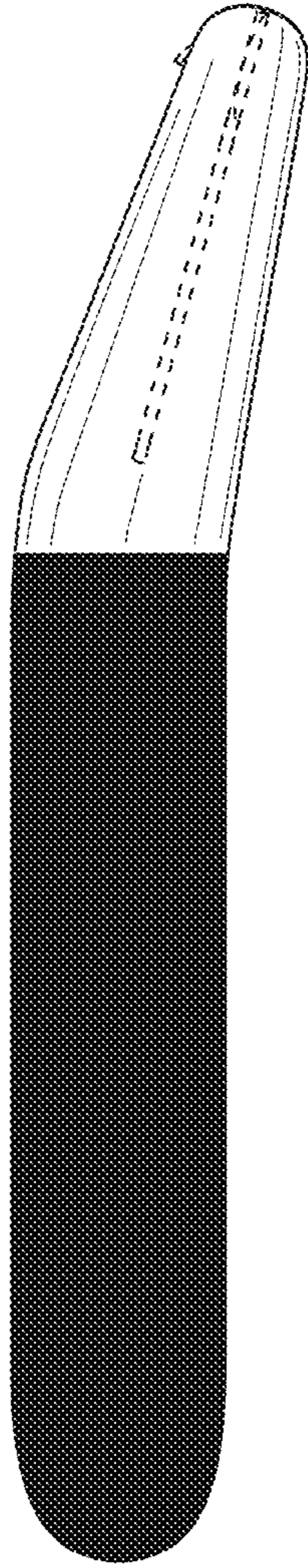

FIG. 12

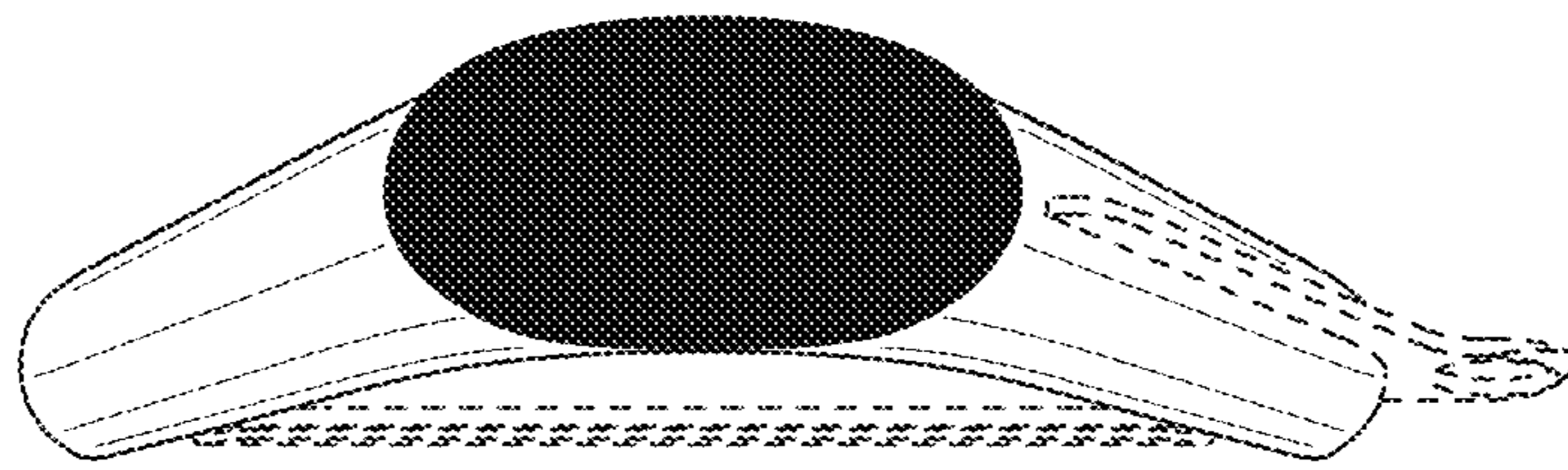

FIG. 13

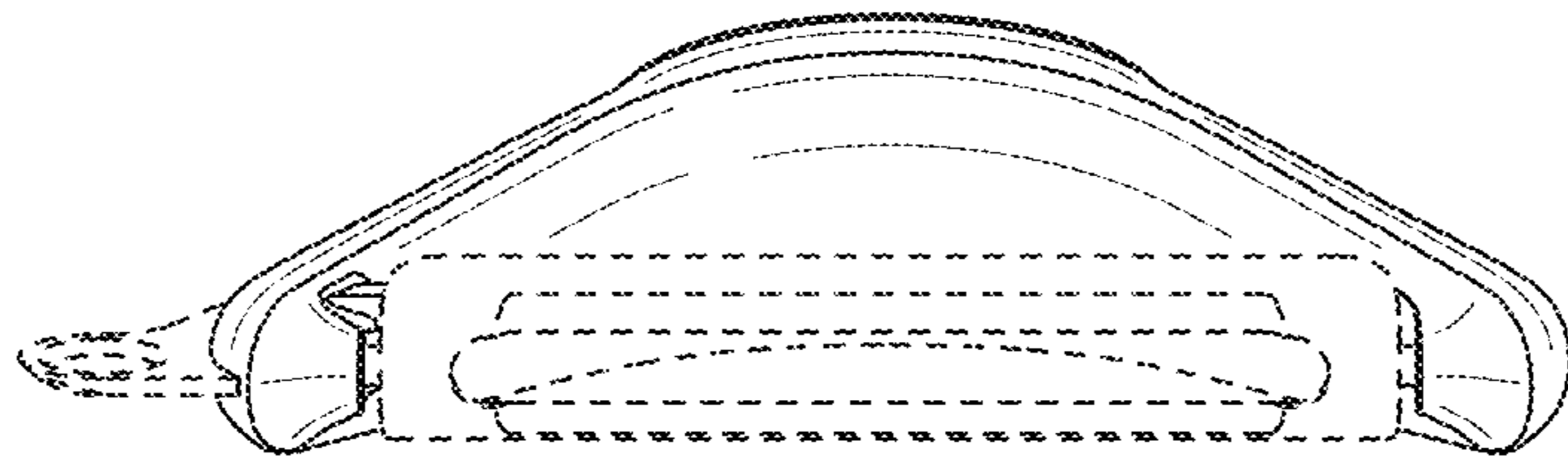

FIG. 14