



US00D766609S

(12) **United States Design Patent**  
**Burden**

(10) **Patent No.:** **US D766,609 S**

(45) **Date of Patent:** **\*\* Sep. 20, 2016**

(54) **ADJUSTABLE BED FRAME**

(71) Applicant: **Ian James Burden**, Gold Coast (AU)

(72) Inventor: **Ian James Burden**, Gold Coast (AU)

(\*\*) Term: **14 Years**

(21) Appl. No.: **29/485,860**

(22) Filed: **Mar. 24, 2014**

(51) **LOC (10) Cl.** ..... **06-02**

(52) **U.S. Cl.**

USPC ..... **D6/384**

(58) **Field of Classification Search**

USPC ..... D6/382-384, 392, 393, 718

CPC .... A47C 19/04; A47C 19/025; A47C 17/86;

A47C 19/00; A47C 19/021

See application file for complete search history.

(56) **References Cited**

**U.S. PATENT DOCUMENTS**

D264,889 S \* 6/1982 Thomas, II ..... D6/384

6,502,256 B1 \* 1/2003 McNeil et al. .... 5/308

7,043,781 B1 \* 5/2006 Madison ..... 5/400

D608,560 S \* 1/2010 Chen ..... D6/384

D608,561 S \* 1/2010 Chen ..... D6/384  
8,869,324 B1 \* 10/2014 Lin ..... 5/400  
2011/0094030 A1 \* 4/2011 Harrington ..... 5/503.1

\* cited by examiner

*Primary Examiner* — Cathron Brooks

(74) *Attorney, Agent, or Firm* — Dykema Gossett PLLC

(57) **CLAIM**

The ornamental design for an adjustable bed frame, as shown and described.

**DESCRIPTION**

FIG. 1 is a top plan view of an adjustable bed frame according to my design in a first retracted state;

FIG. 2 is a bottom plan view thereof;

FIG. 3 is a front elevation view thereof;

FIG. 4 is a left side view thereof;

FIG. 5 is a right side view thereof;

FIG. 6 is a top, right, front perspective view thereof;

FIG. 7 is a top plan view thereof in an extended state;

FIG. 8 is a bottom plan view thereof; and,

FIG. 9 is a front elevation view thereof.

The broken lines shown in the figures illustrate portions of the adjustable bed frame that form no part of the claimed design.

**1 Claim, 8 Drawing Sheets**

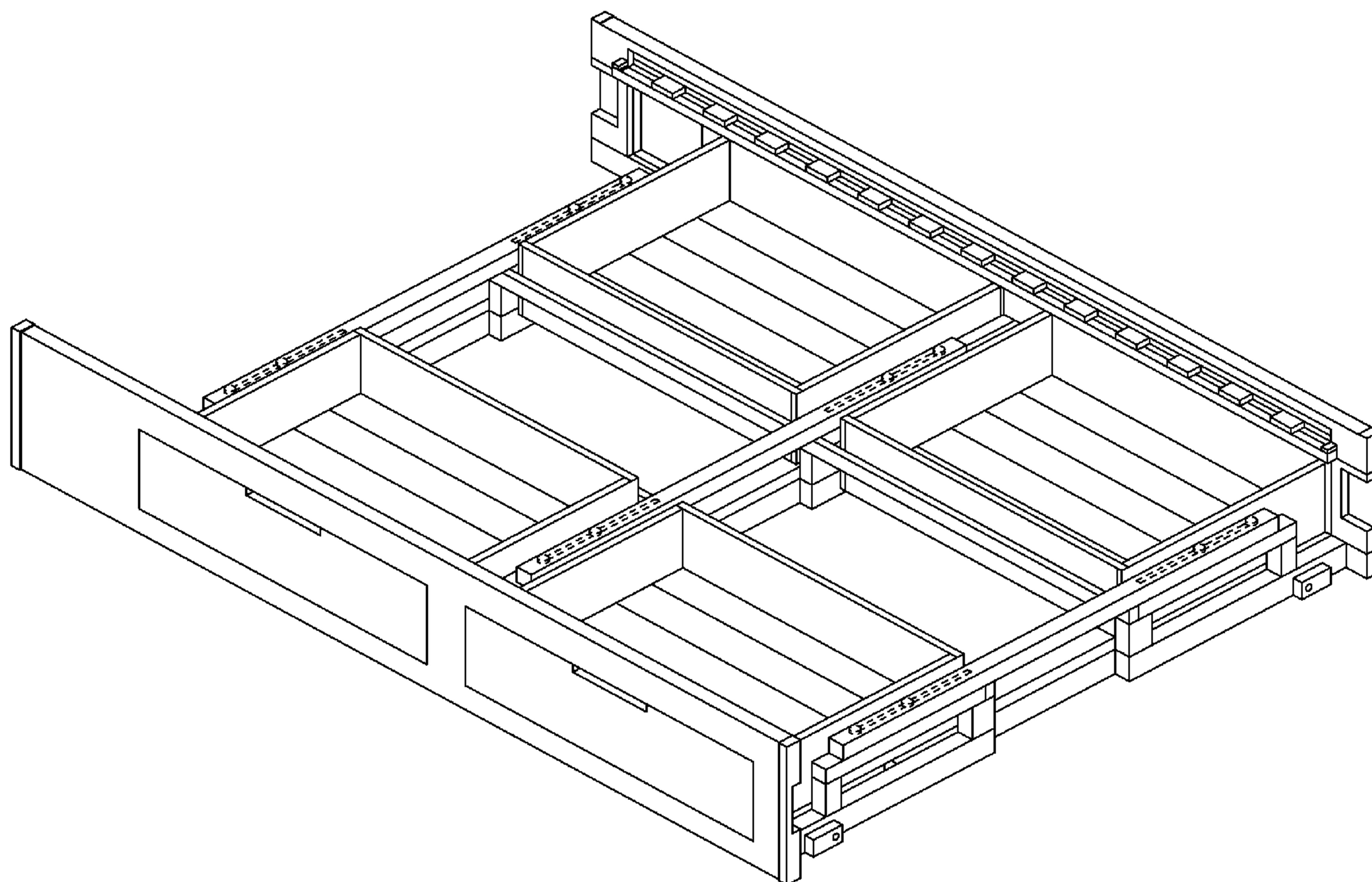

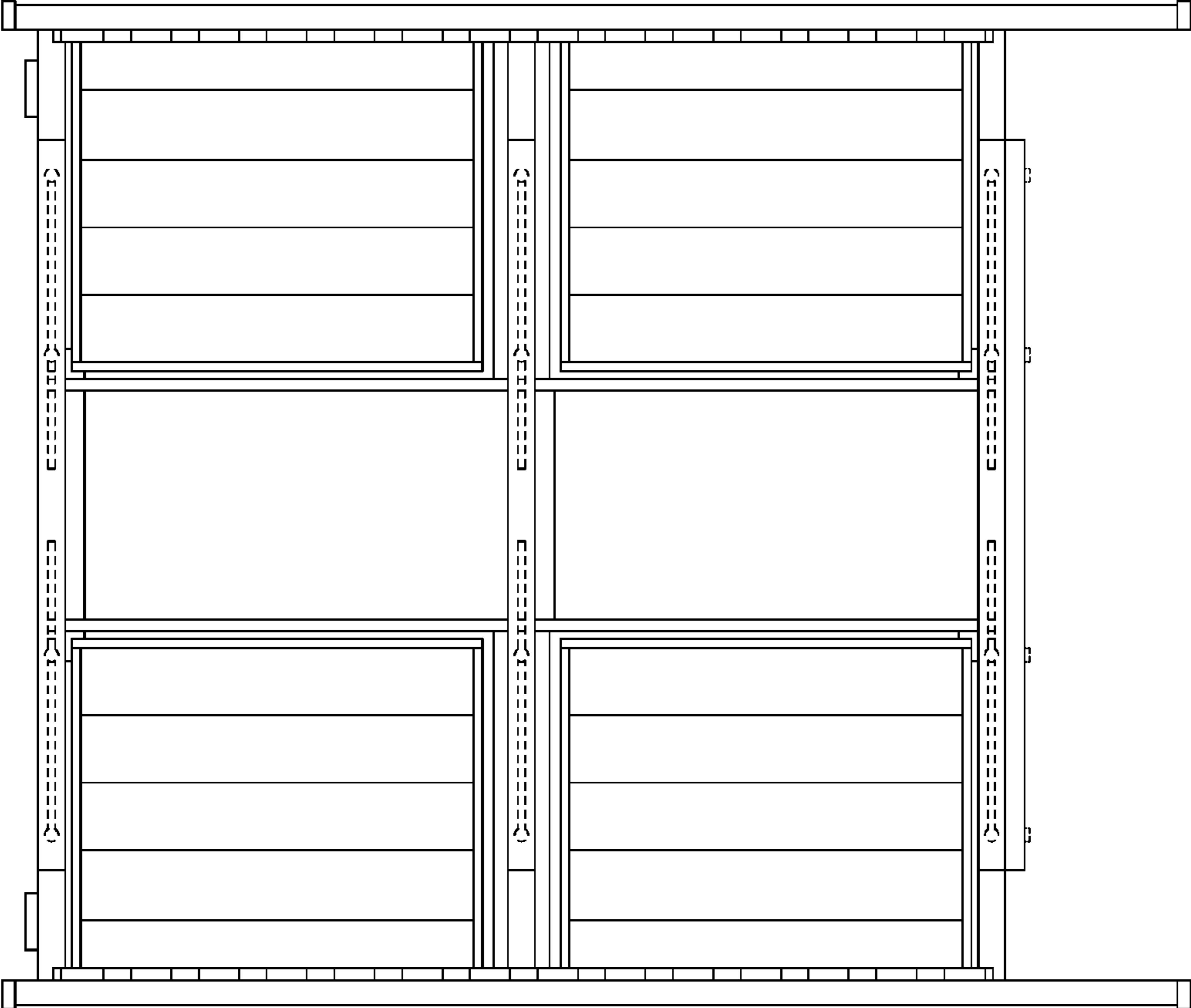

FIG. 1

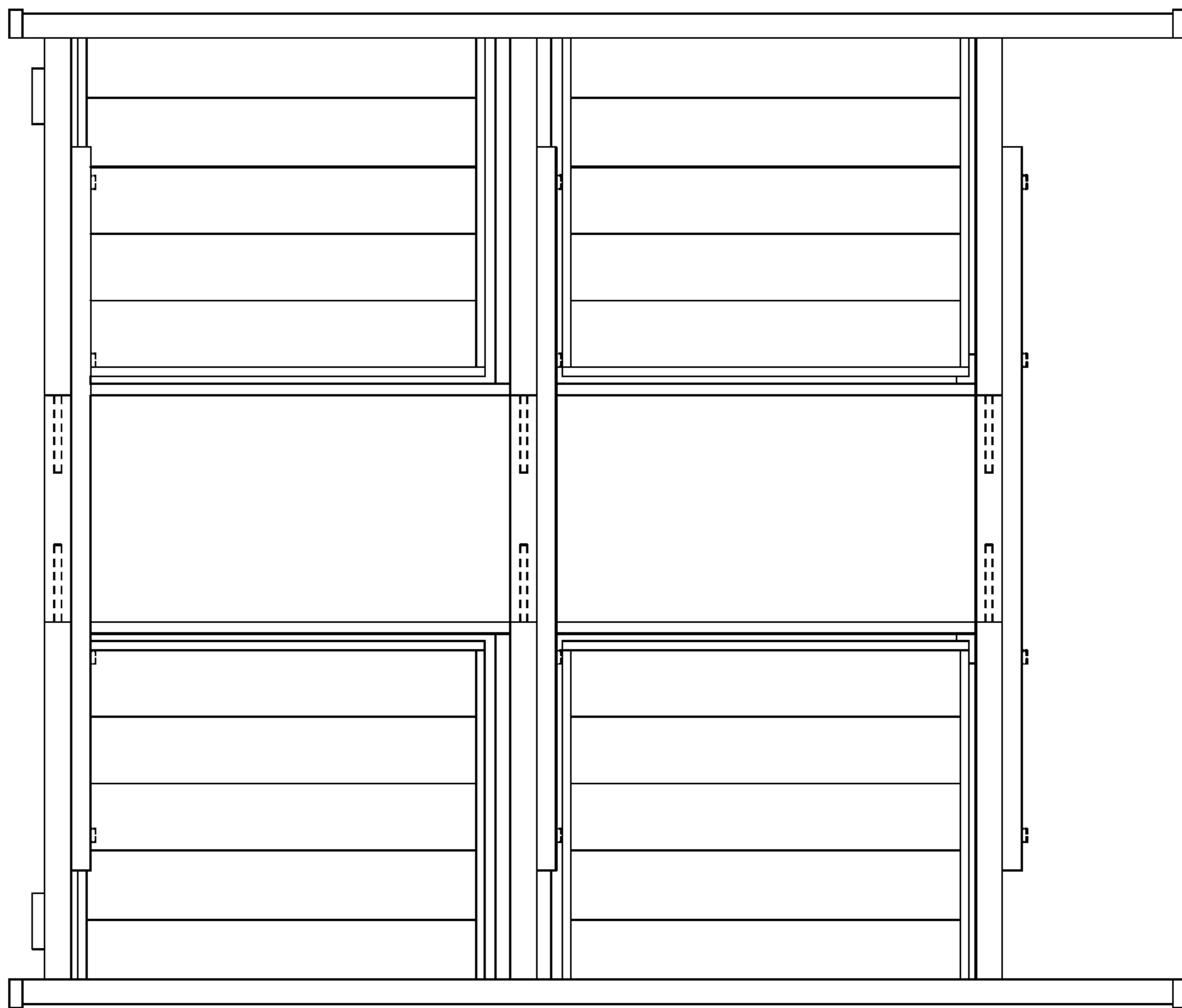
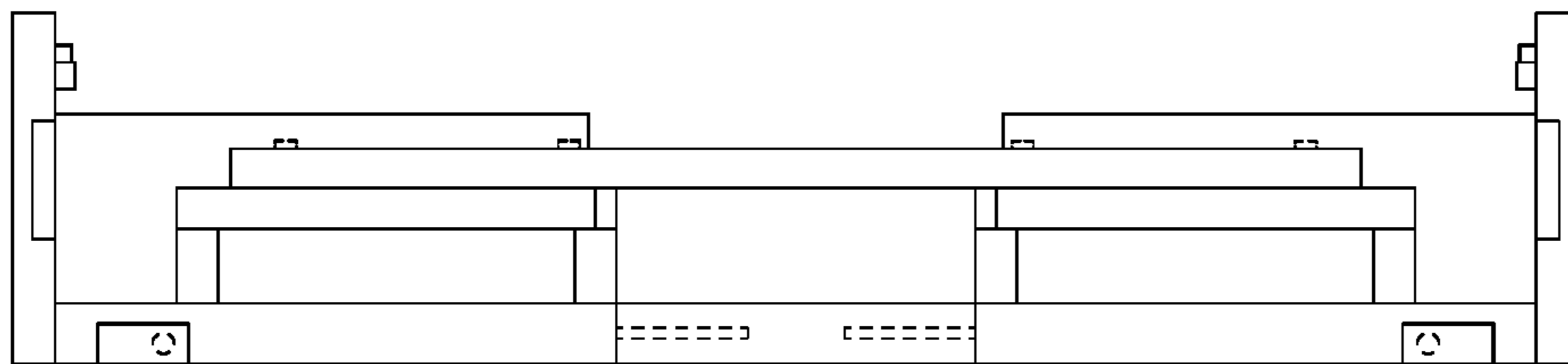
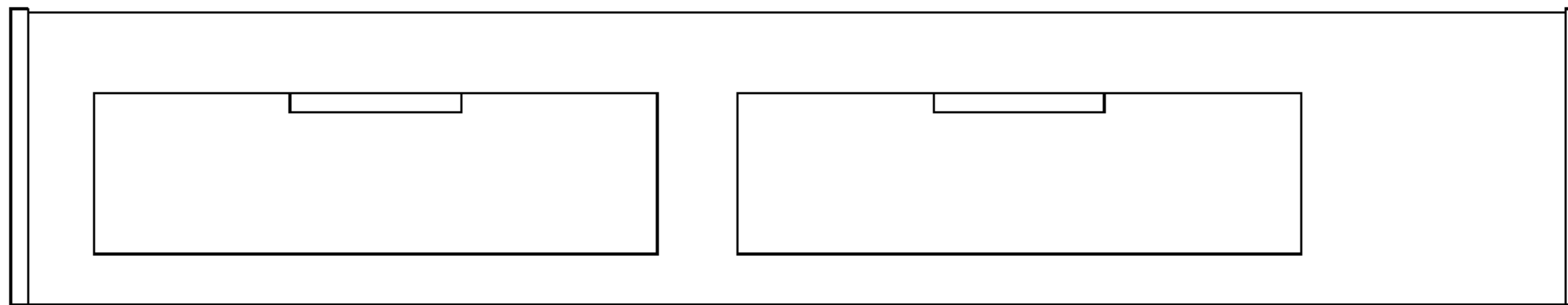

FIG. 2



**FIG. 3**



**FIG. 4**

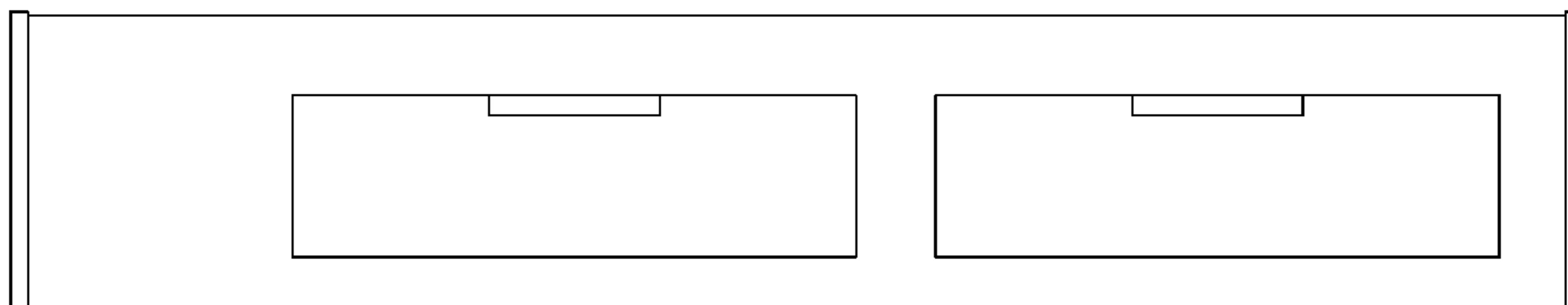

**FIG. 5**

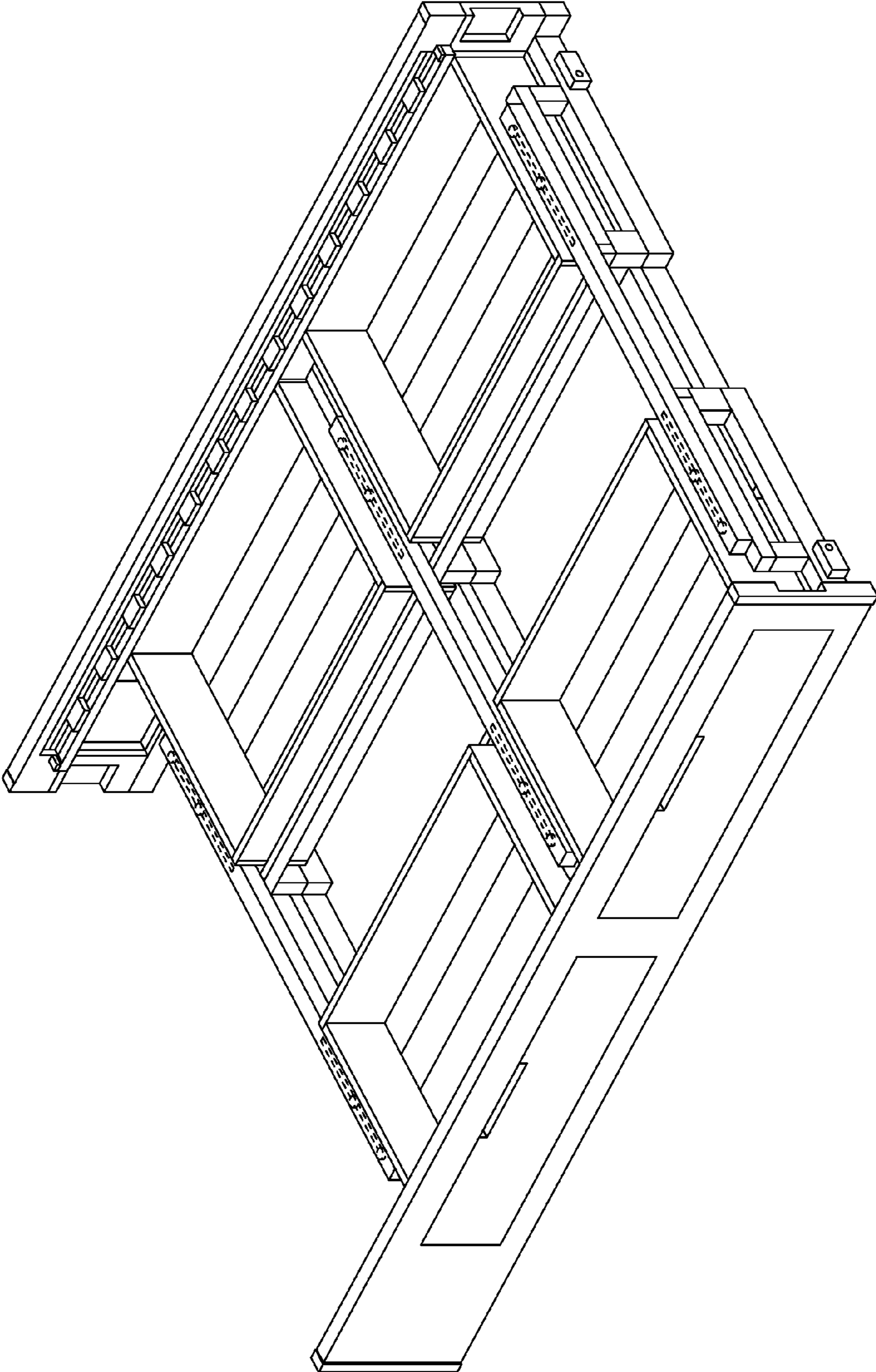

**FIG. 6**

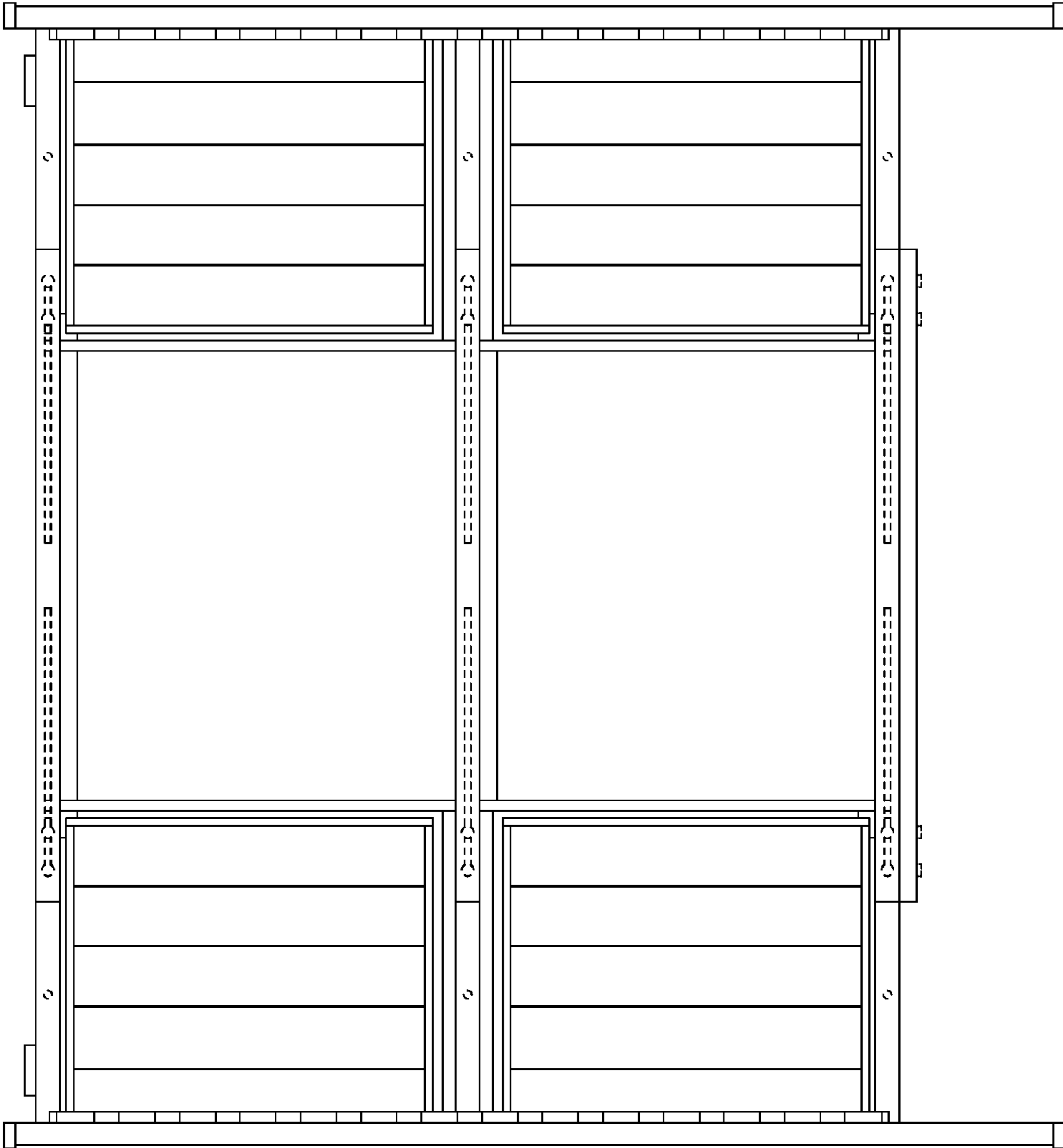

FIG. 7

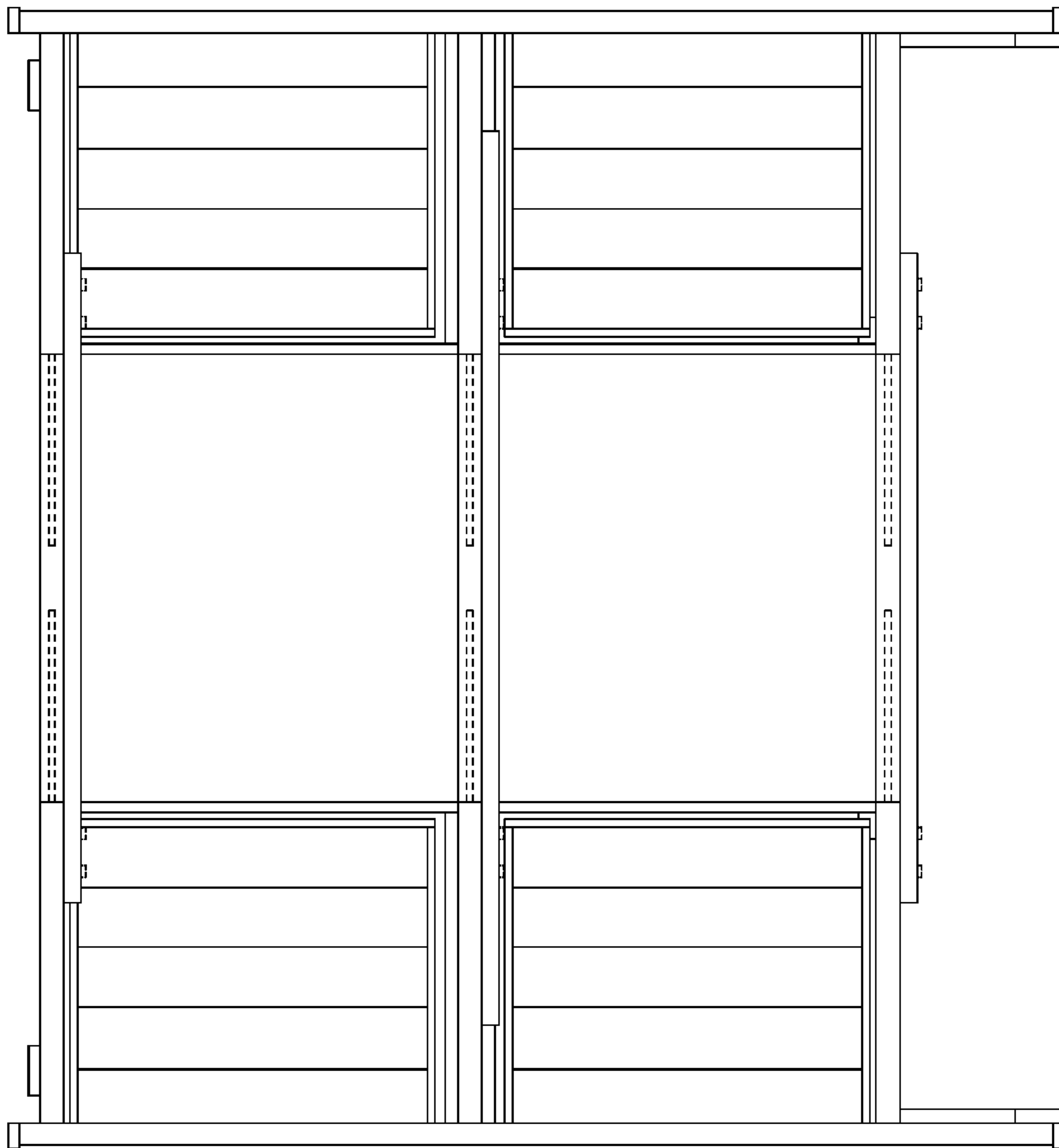

FIG. 8





**FIG. 9**

UNITED STATES PATENT AND TRADEMARK OFFICE  
**CERTIFICATE OF CORRECTION**

PATENT NO. : D766,609 S  
APPLICATION NO. : 29/485860  
DATED : September 20, 2016  
INVENTOR(S) : Burden

Page 1 of 1

It is certified that error appears in the above-identified patent and that said Letters Patent is hereby corrected as shown below:

TITLE PAGE

Insert

--(30) Foreign Application Priority Data

Sept. 24, 2013 (AU) ..... 14835/2013--

Signed and Sealed this  
Eighth Day of November, 2016



Michelle K. Lee  
*Director of the United States Patent and Trademark Office*