



US00D766606S

(12) **United States Design Patent**  
**Volpe**

(10) **Patent No.:** **US D766,606 S**

(45) **Date of Patent:** **\*\* Sep. 20, 2016**

(54) **CHAIR**

(71) Applicant: **The McGuire Furniture Company,**  
San Francisco, CA (US)

(72) Inventor: **Steven Volpe,** San Francisco, CA (US)

(73) Assignee: **KOHLER INTERIORS FURNITURE**  
**COMPANY,** Hickory, NC (US)

(\*\*) Term: **14 Years**

(21) Appl. No.: **29/506,646**

(22) Filed: **Oct. 17, 2014**

(51) **LOC (10) Cl.** ..... **06-01**

(52) **U.S. Cl.**  
USPC ..... **D6/373**

(58) **Field of Classification Search**

USPC ..... D6/334-336, 371, 373, 374, 375, 376,  
D6/379, 380, 716, 716.1, 716.4, 370

CPC ..... A47C 3/03; A47C 4/02; A47C 4/03;  
A47C 5/06; A47C 5/12; A47C 7/22

See application file for complete search history.

(56) **References Cited**

**U.S. PATENT DOCUMENTS**

D239,890 S *	5/1976	Uyeda .....	D6/373
D285,753 S *	9/1986	Zola .....	D6/373
D294,436 S *	3/1988	Colby .....	D6/379
D296,848 S *	7/1988	Colby .....	D6/379
D298,787 S *	12/1988	Greene .....	D6/370
D331,325 S *	12/1992	Grosfillex .....	D6/370
D350,444 S *	9/1994	Lowsky .....	D6/373
D467,444 S *	12/2002	Hess .....	D6/370
D606,329 S *	12/2009	Van Duysen .....	D6/375

\* cited by examiner

*Primary Examiner* — Mimosa De

(74) *Attorney, Agent, or Firm* — Foley & Lardner LLP

(57) **CLAIM**

We claim the ornamental design for a chair, as shown and described.

**DESCRIPTION**

FIG. 1 is a top, front, right perspective view of an embodiment of the claimed design;

FIG. 2 is a front elevation view thereof;

FIG. 3 is a rear elevation view thereof;

FIG. 4 is a left elevation view thereof, the right elevation view being a mirror image thereof;

FIG. 5 is a top plan view thereof;

FIG. 6 is a bottom plan view thereof;

FIG. 7 is a top, front, right perspective view of another embodiment of the claimed design;

FIG. 8 is a front elevation view thereof;

FIG. 9 is a rear elevation view thereof;

FIG. 10 is a left elevation view thereof, the right elevation view being a mirror image thereof;

FIG. 11 is a top plan view thereof; and,

FIG. 12 is a bottom plan view thereof.

The ornamental design which is claimed is shown in solid lines in the drawings. The broken lines in the drawings form no part of the claimed design. Broken lines formed by equal length dashes show unclaimed subject matter. Broken lines formed of unequal length dashes (i.e., dash-dot) define bounds of the claimed design. Broken away symbols having a jagged element show that no particular length of the portion is claimed.

**1 Claim, 12 Drawing Sheets**

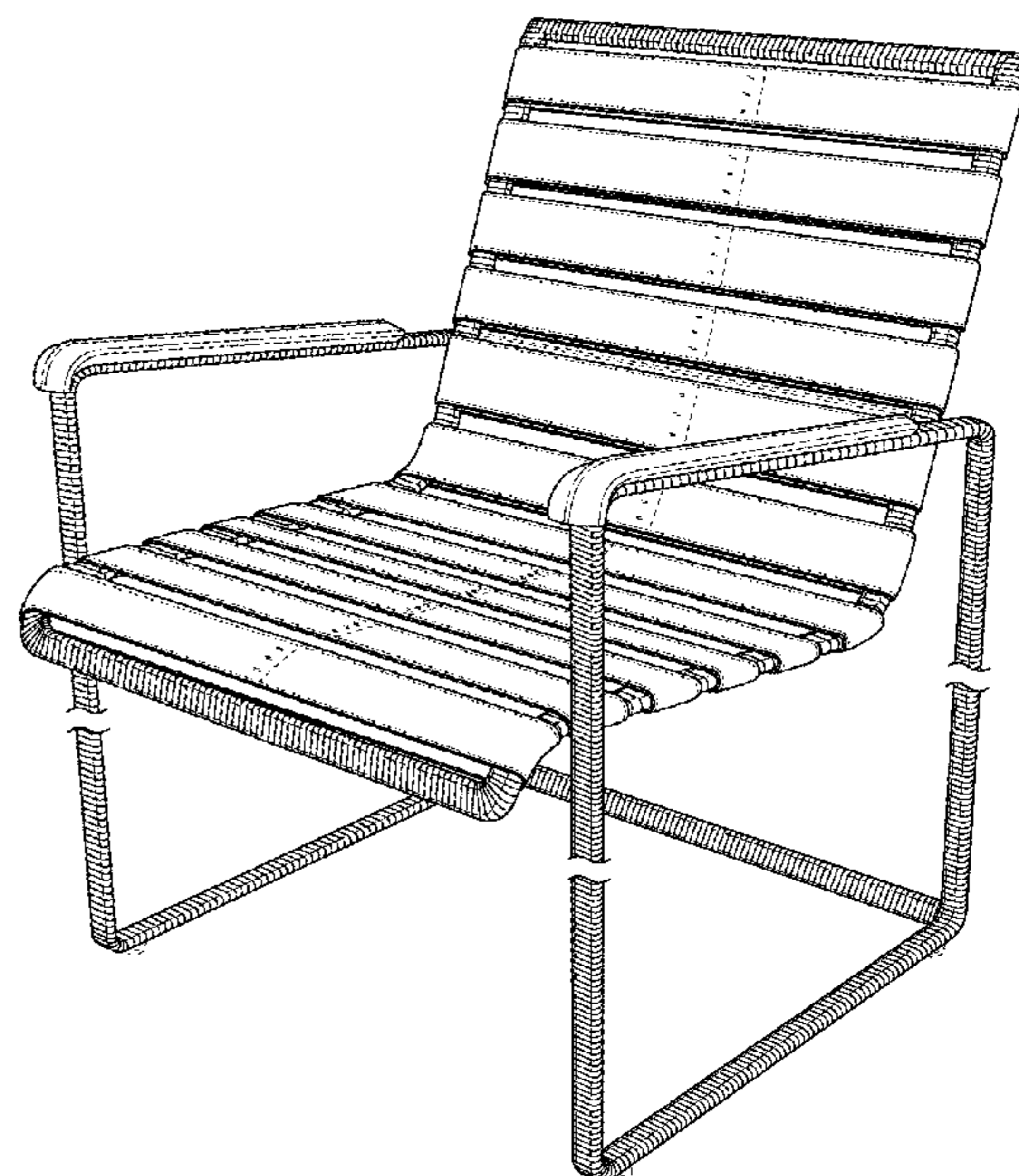
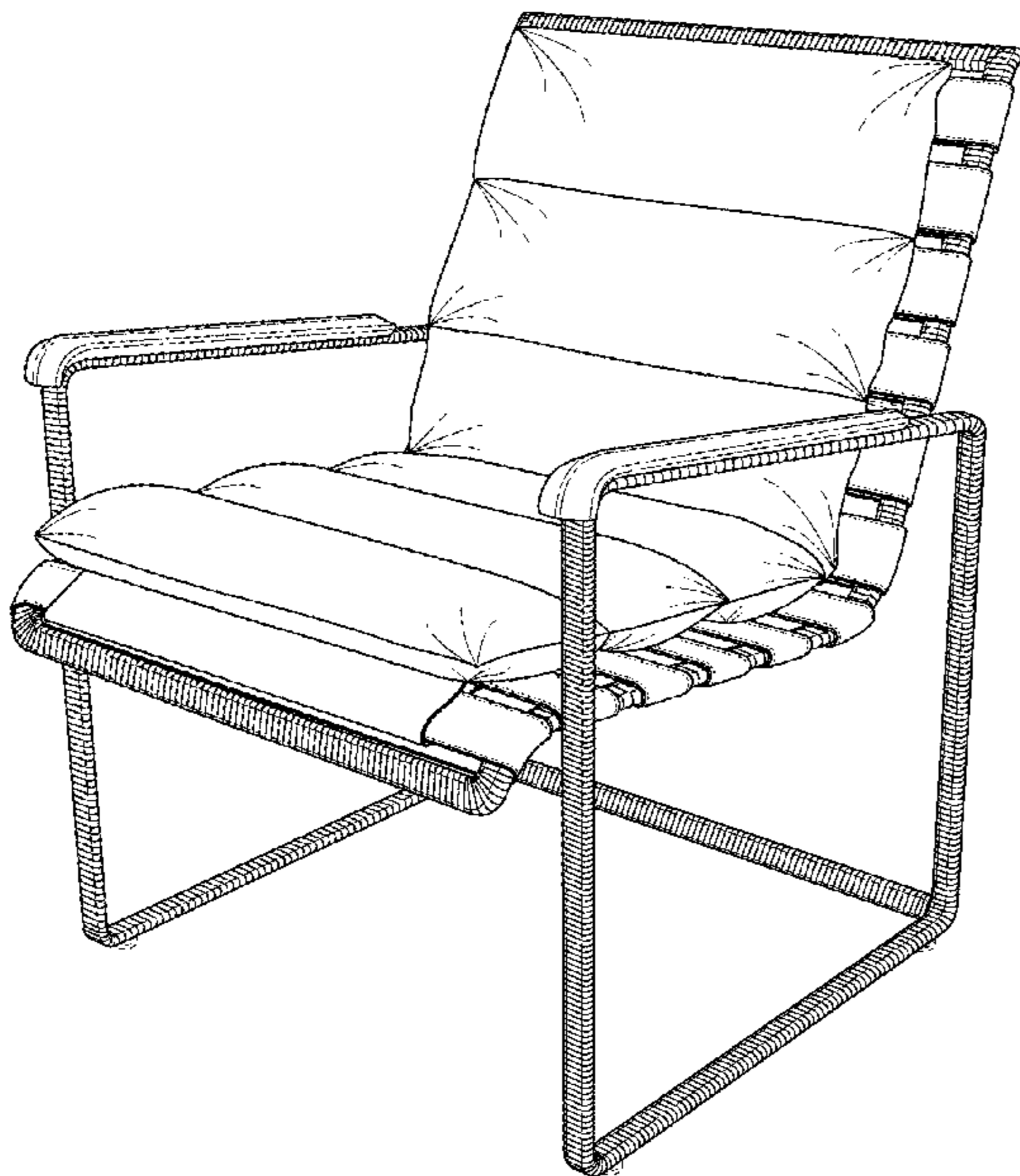

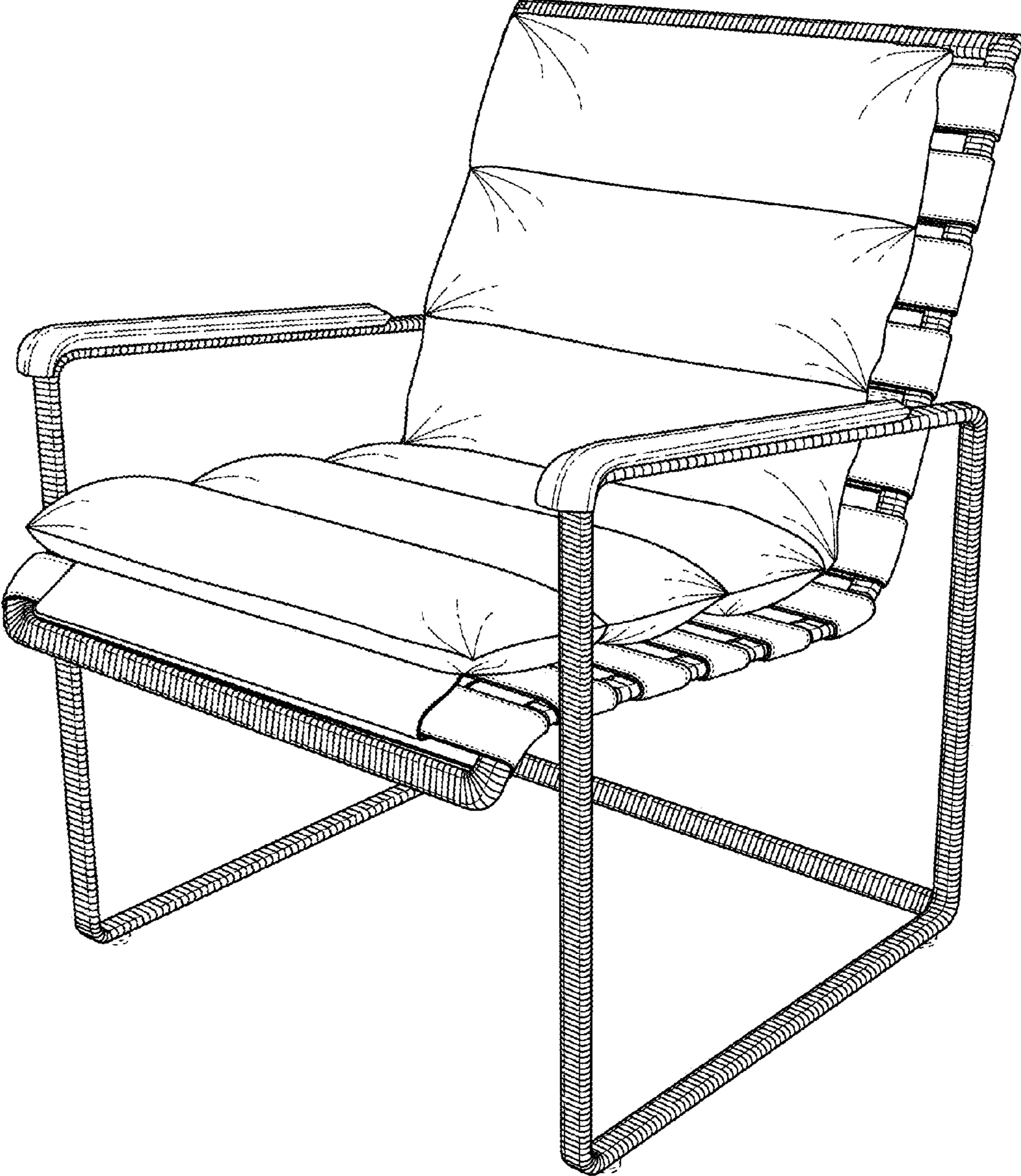

FIG. 1

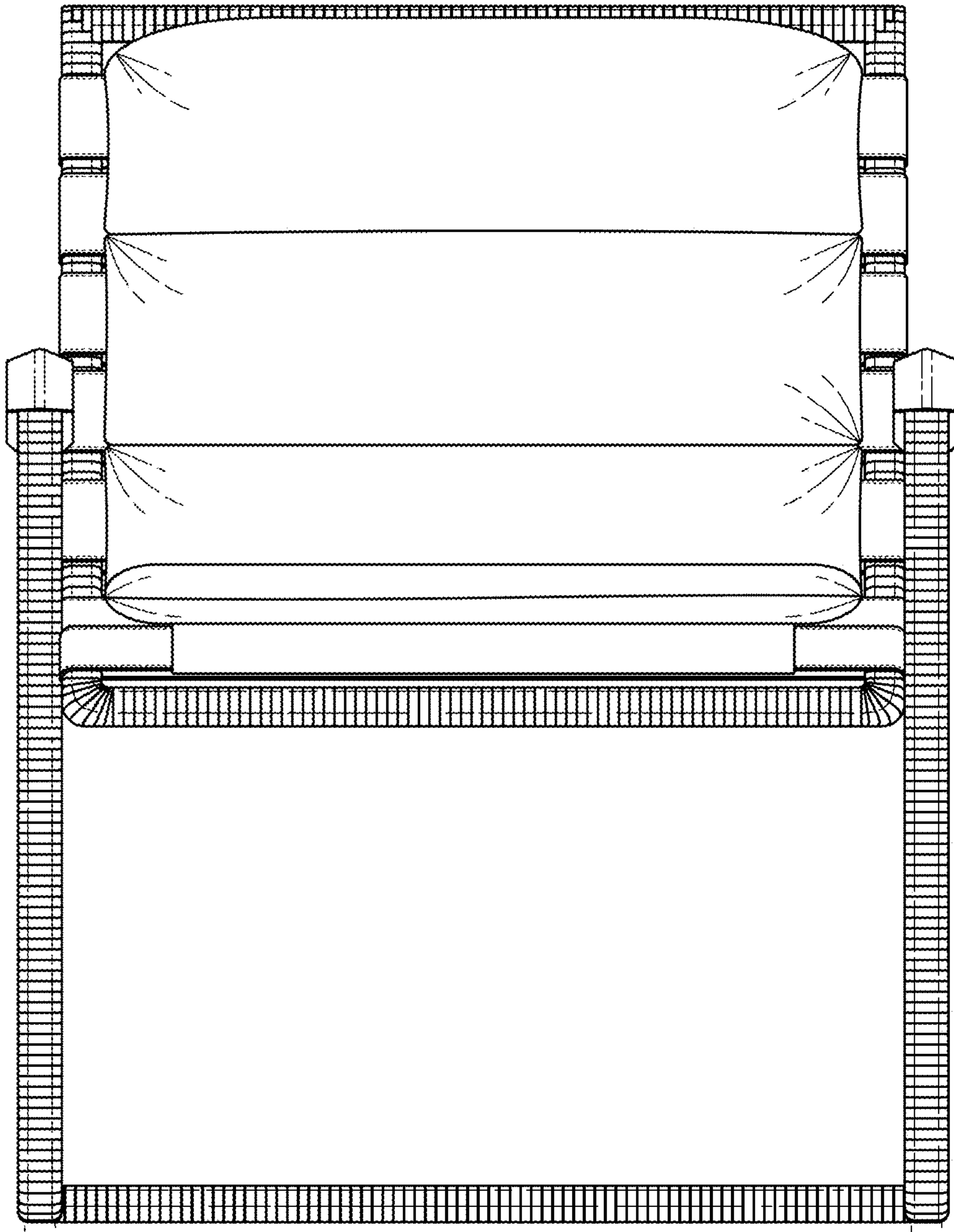

FIG. 2

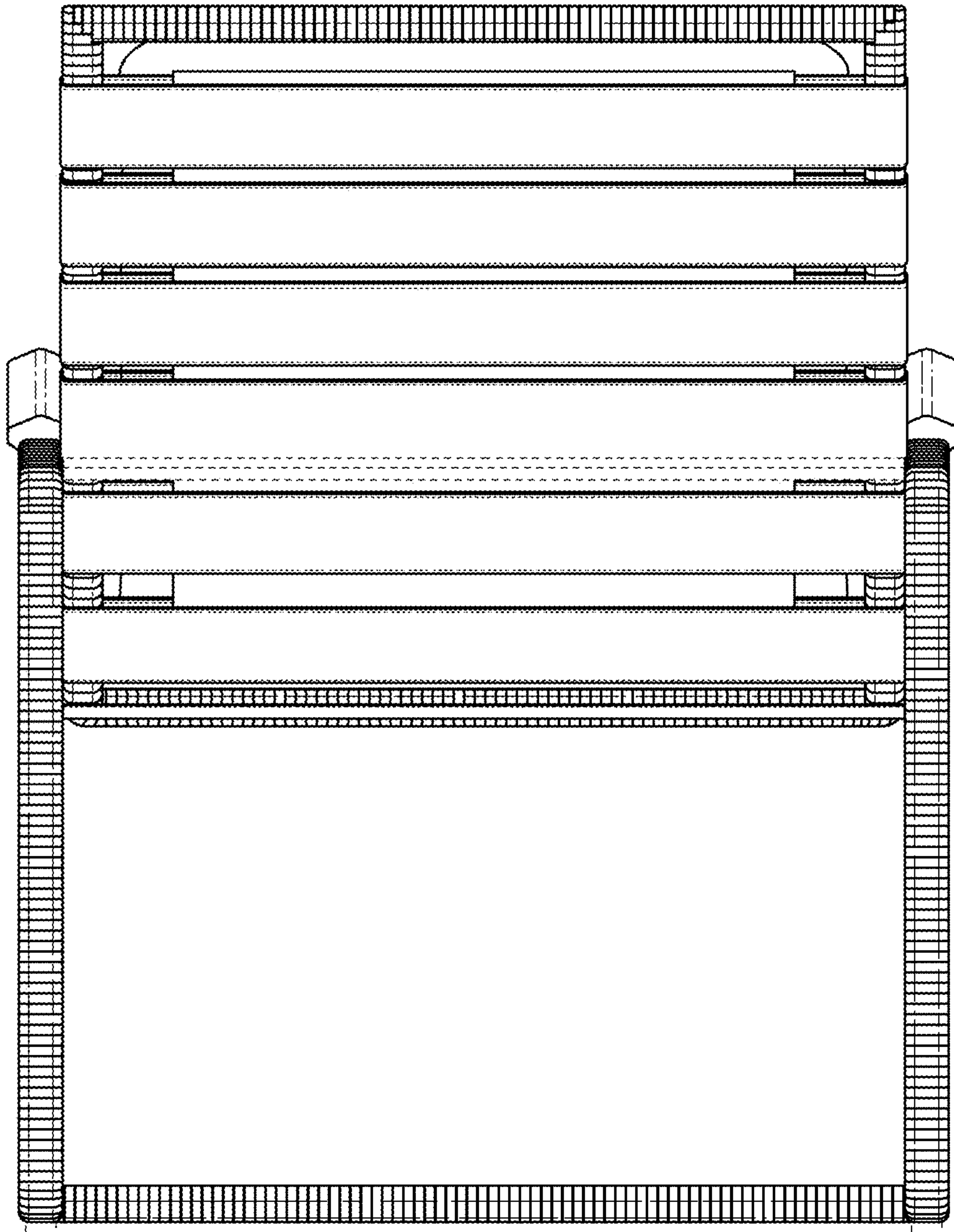

FIG. 3

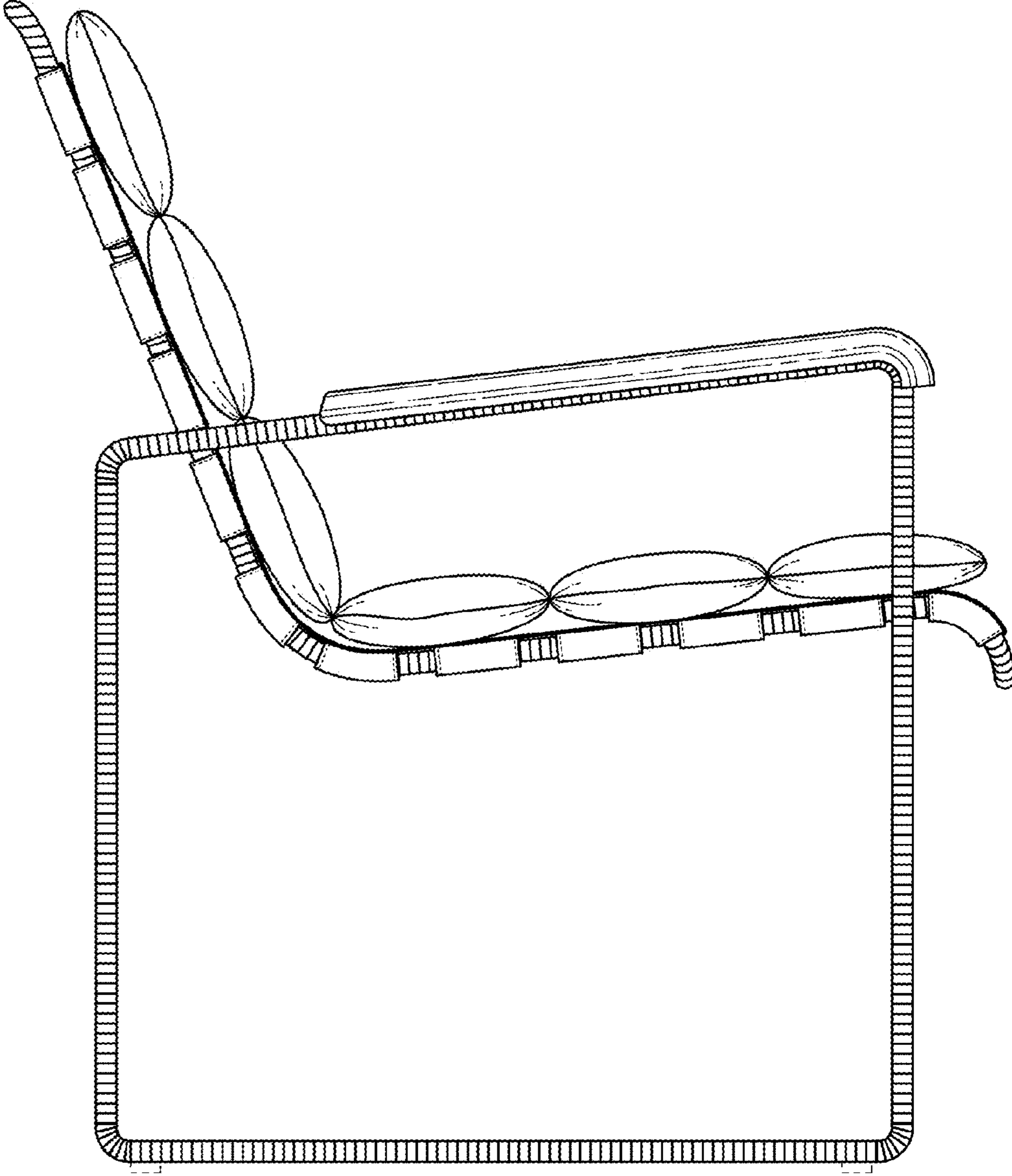

FIG. 4

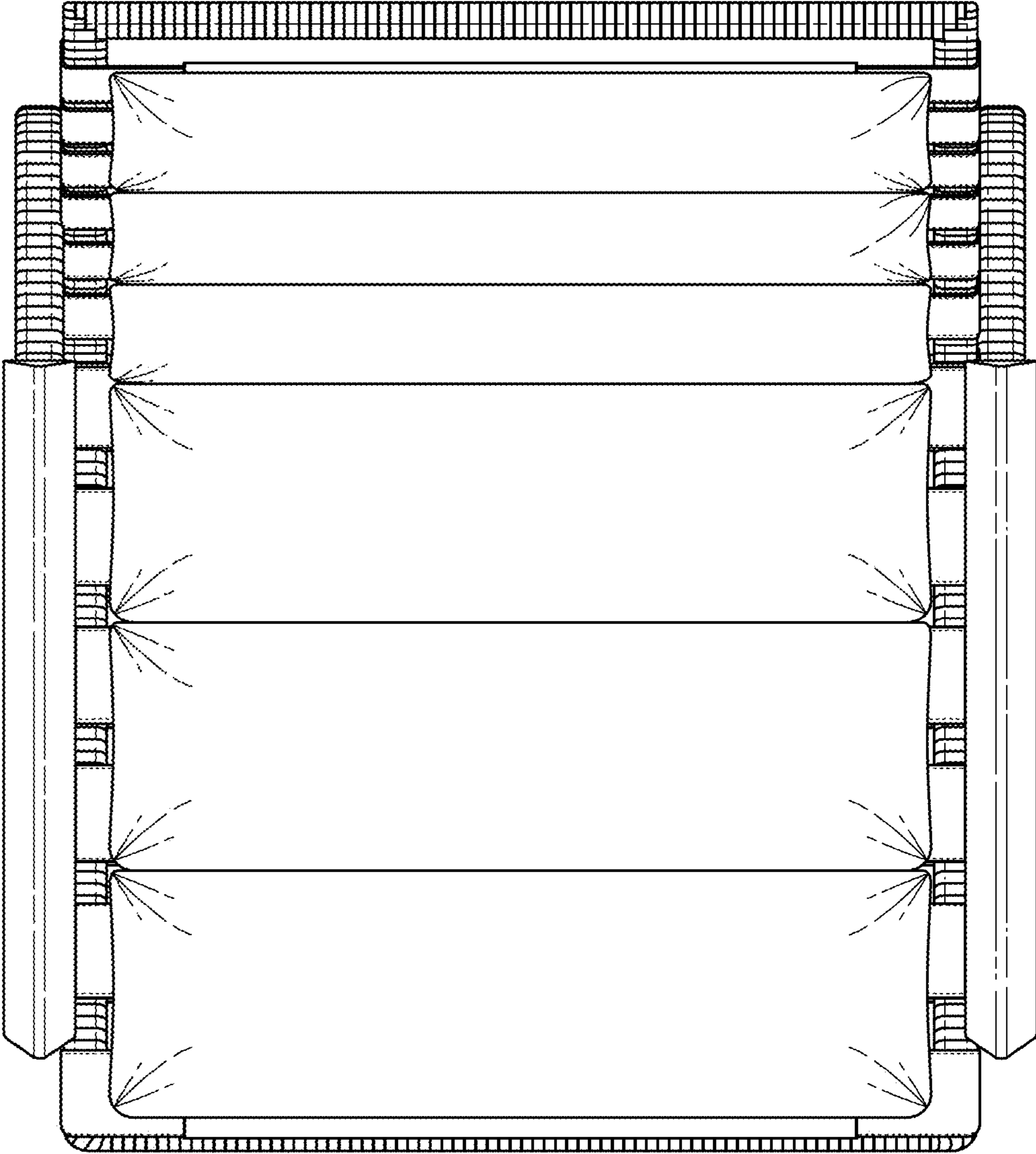

FIG. 5

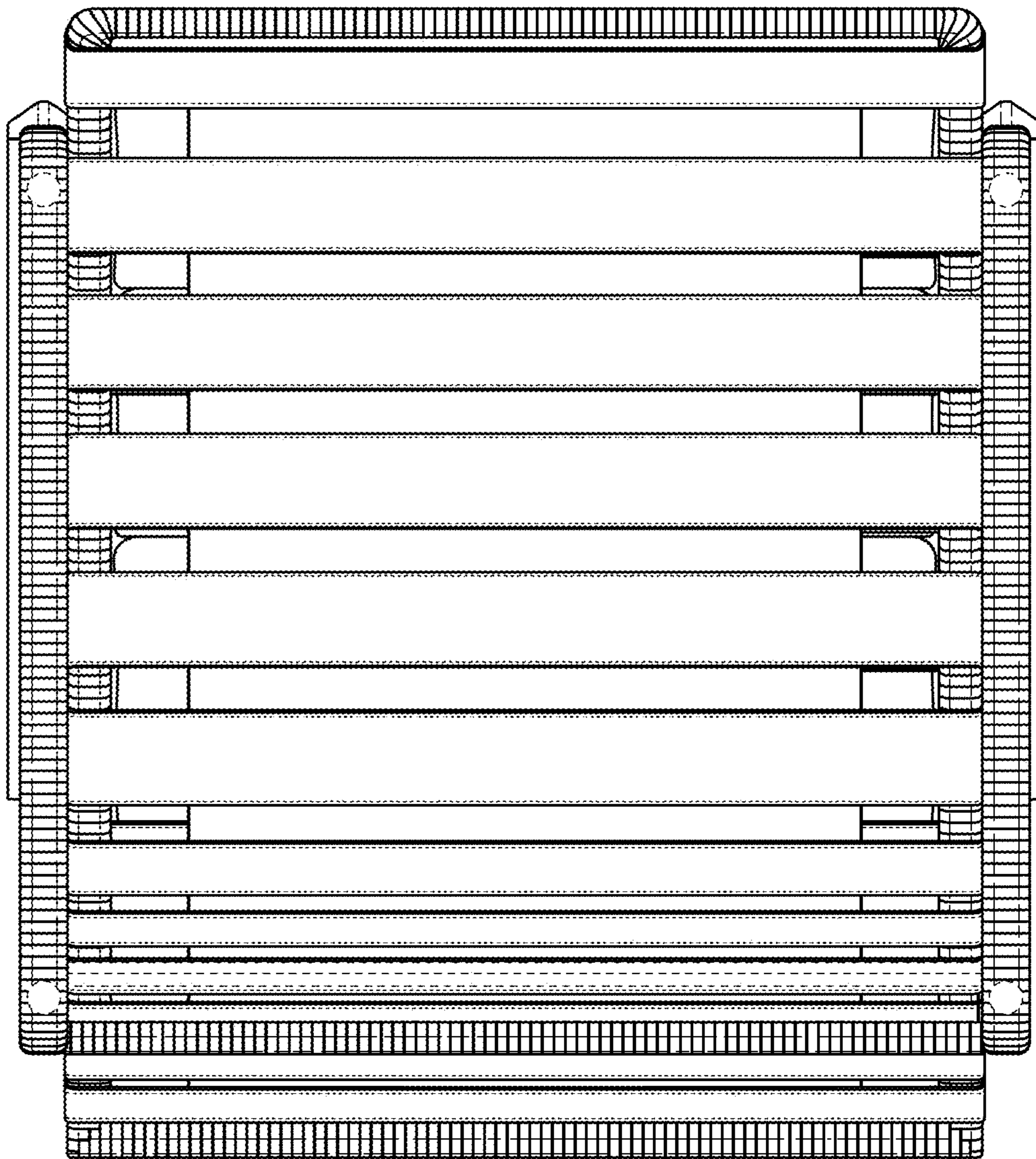

FIG. 6

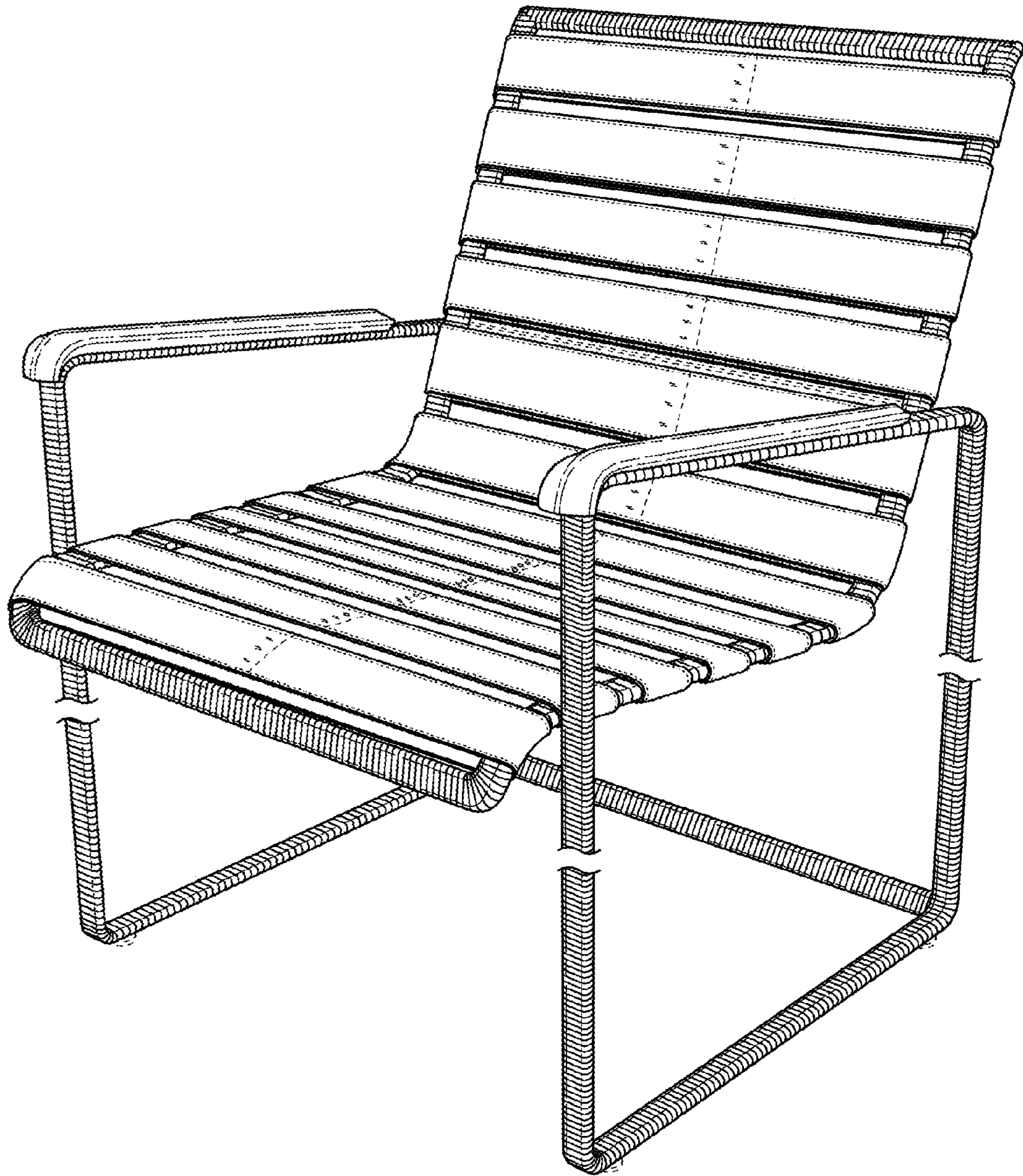

FIG. 7



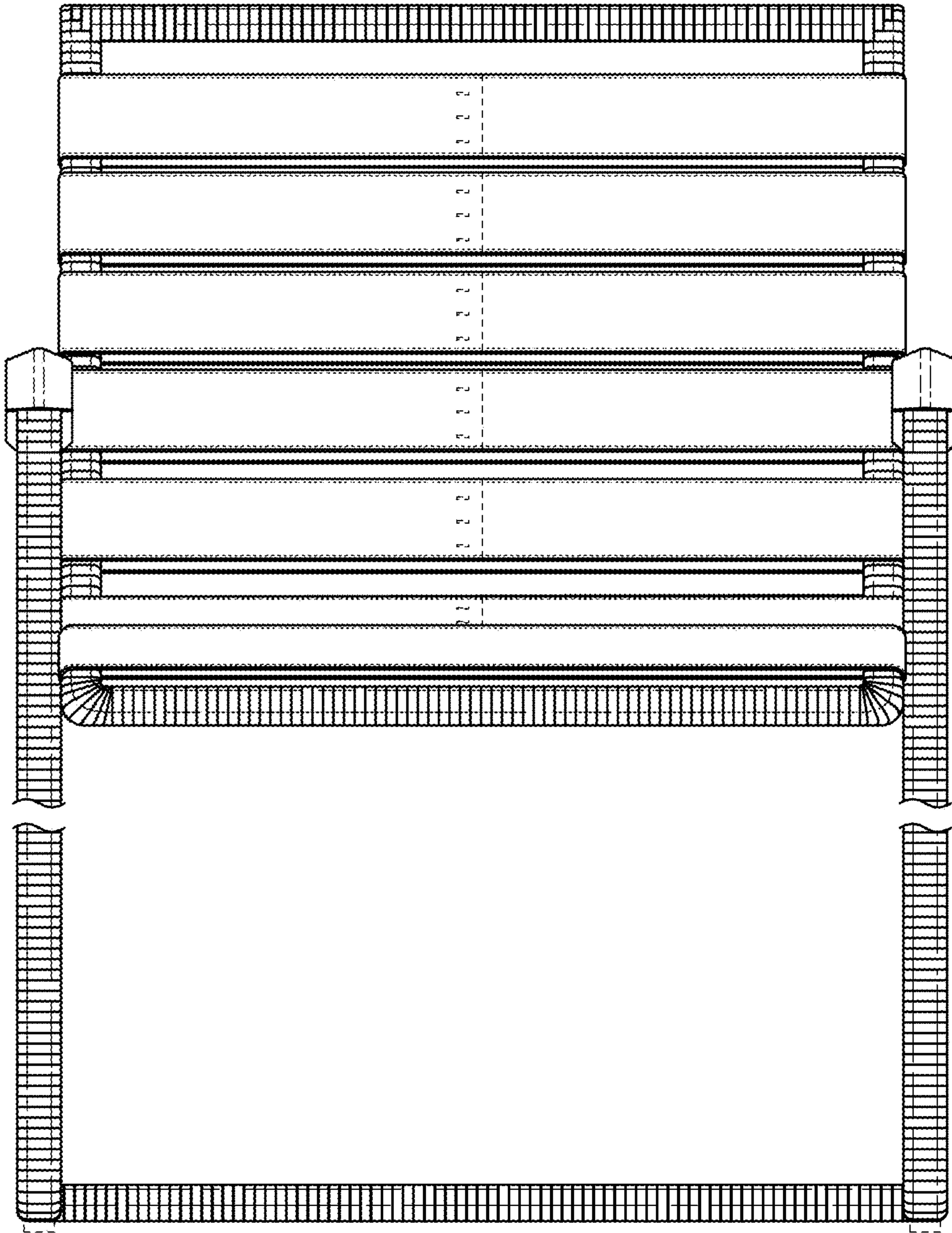

FIG. 8

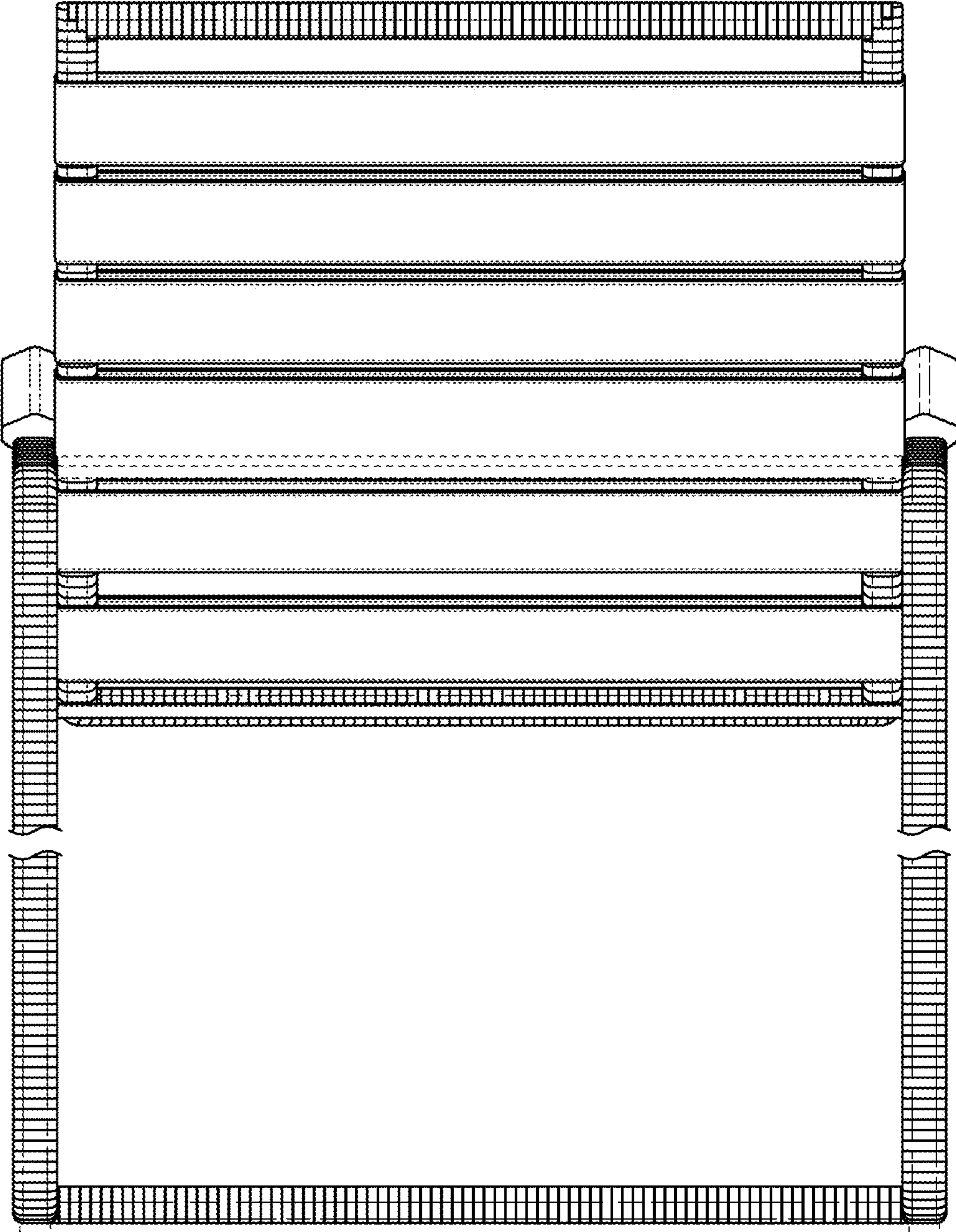

FIG. 9

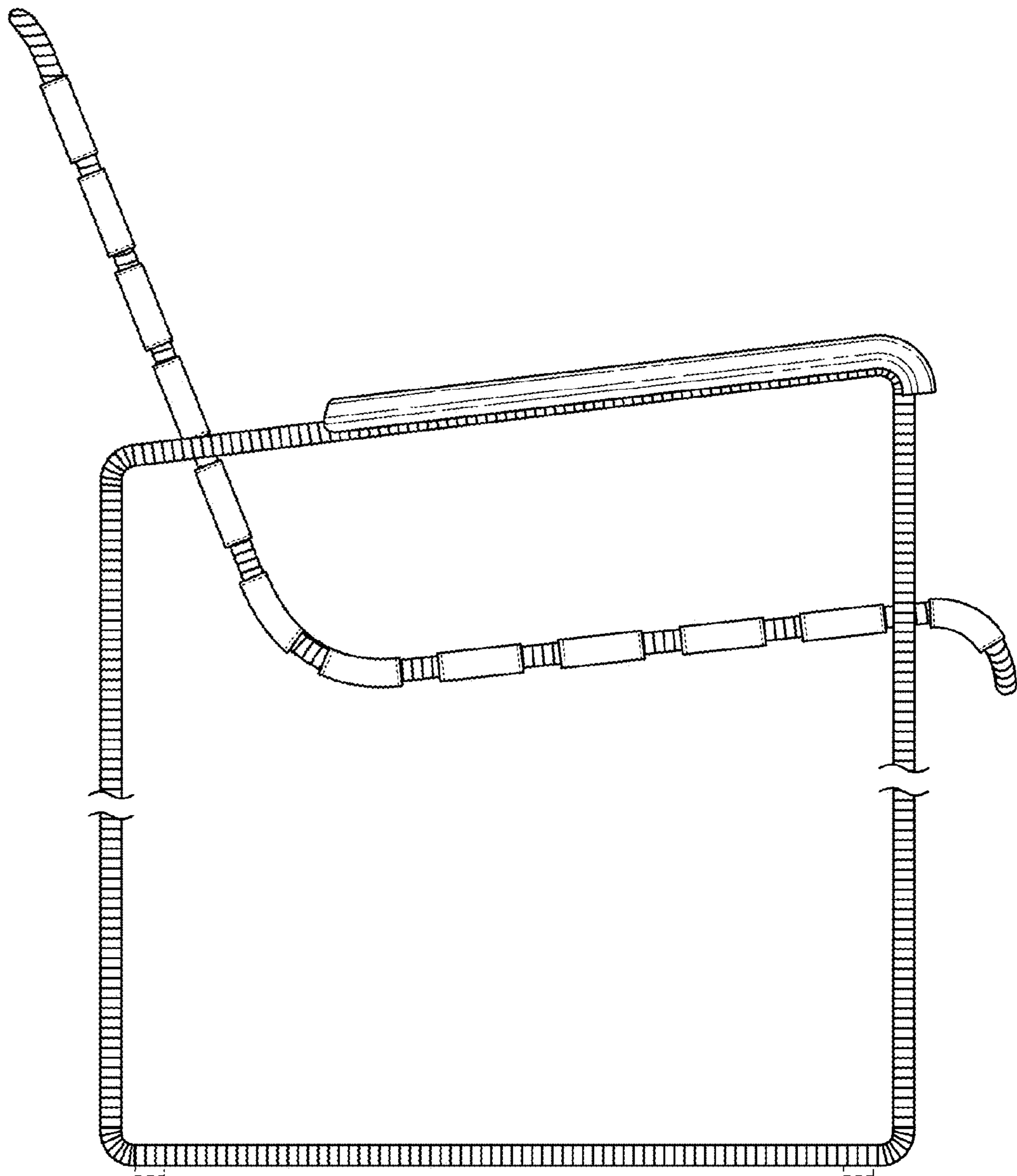

FIG. 10

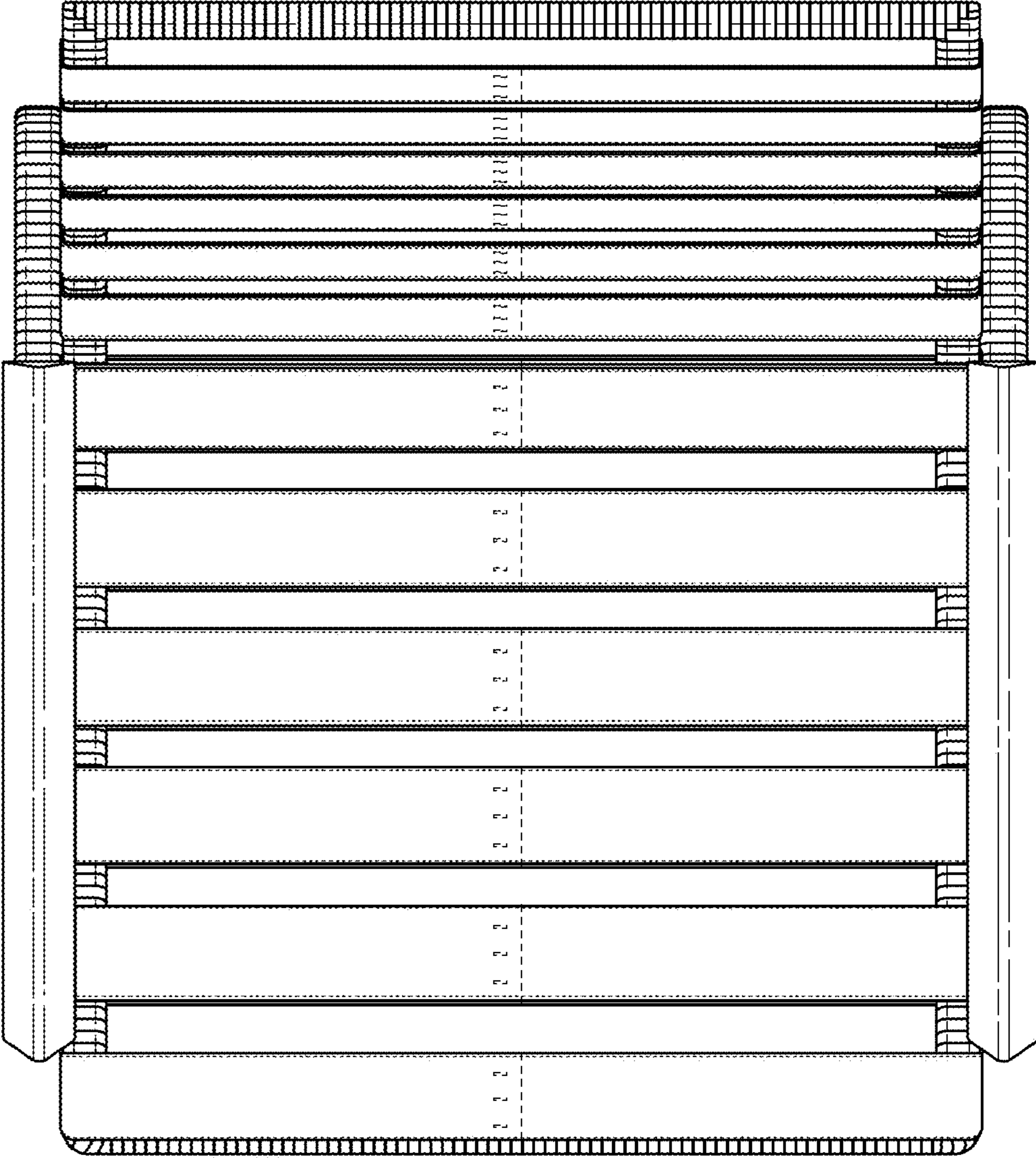

FIG. 11

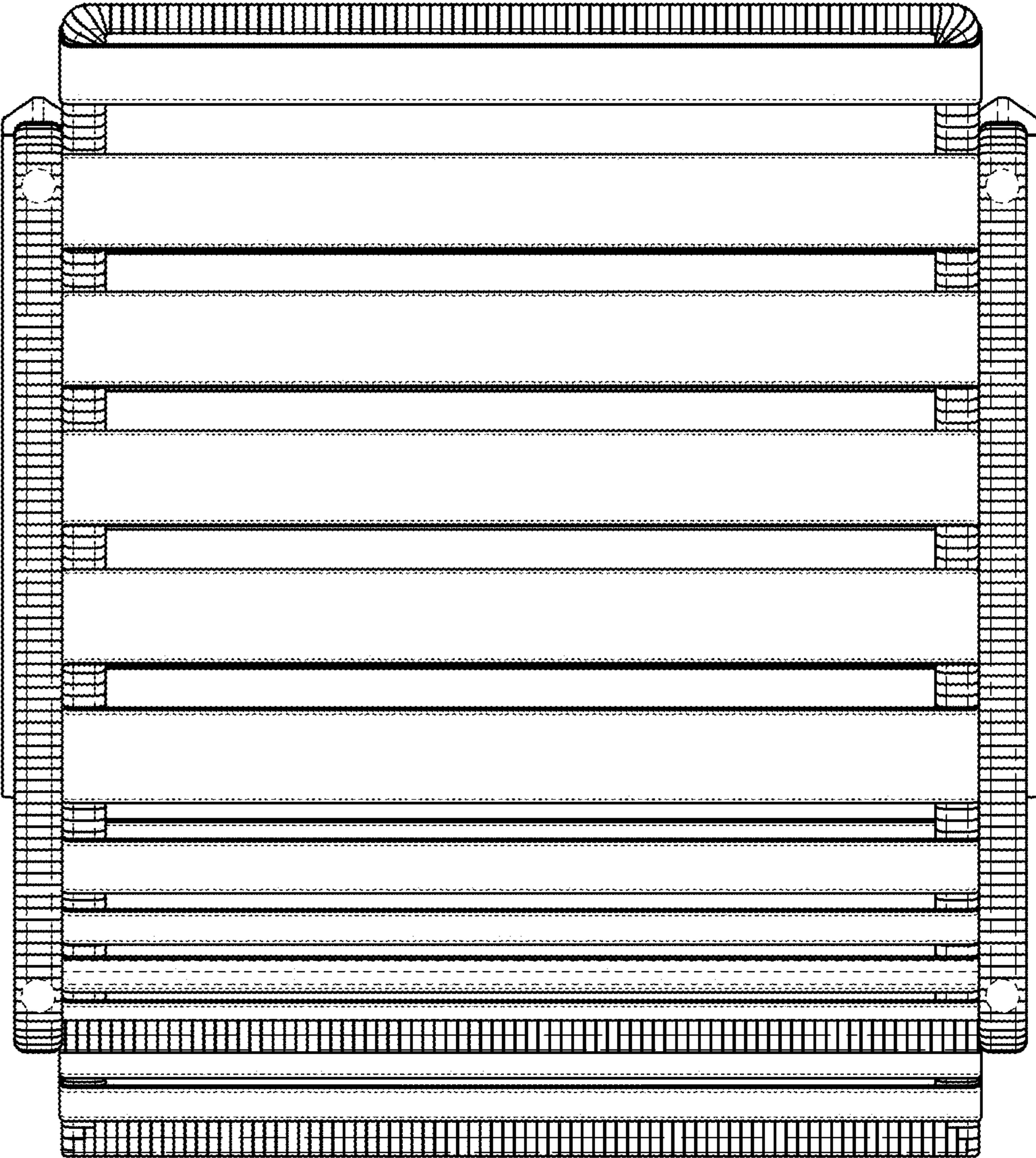

FIG. 12