

US00D766537S

(12) **United States Design Patent** (10) **Patent No.:** **US D766,537 S**
Thuma et al. (45) **Date of Patent:** **** Sep. 13, 2016**

- (54) **REFUSE CONTAINER**
- (71) Applicant: **Suncast Technologies, LLC**, Palm Beach Gardens, FL (US)
- (72) Inventors: **Michael Thuma**, La Grange, IL (US); **Michael R. Vogler**, Oswego, IL (US)
- (73) Assignee: **Suncast Technologies, LLC**, Palm Beach Gardens, FL (US)
- (**) Term: **15 Years**
- (21) Appl. No.: **29/533,194**
- (22) Filed: **Jul. 15, 2015**
- (51) **LOC (10) Cl.** **09-09**
- (52) **U.S. Cl.**
USPC **D34/7**
- (58) **Field of Classification Search**
USPC D34/1-11; 220/908, 263, 260, 4.28, 220/4.32, 812
CPC B65F 1/02; B65F 1/1607; B65F 1/1615
See application file for complete search history.

- (56) **References Cited**
- U.S. PATENT DOCUMENTS
- 3,394,832 A * 7/1968 McAllister B65F 1/06
220/254.3
- D229,279 S * 11/1973 Kay D34/1
- D232,211 S * 7/1974 Kay D34/1
- 5,967,355 A * 10/1999 Ragot B65F 1/02
220/4.32
- D493,591 S * 7/2004 Skalka D34/7

- D507,687 S * 7/2005 Moon D34/1
- 7,073,677 B2 * 7/2006 Richardson B65F 1/02
220/4.32
- D537,222 S * 2/2007 Presnell D34/7
- D551,414 S * 9/2007 Weiss D34/1
- D644,391 S * 8/2011 Kopp D34/7
- D707,108 S * 6/2014 Fischer, Jr. D8/359
- 2005/0016999 A1 * 1/2005 Richardson B65F 1/02
220/4.28

* cited by examiner

Primary Examiner — Cynthia Ramirez
Assistant Examiner — Gino Colan
 (74) *Attorney, Agent, or Firm* — McHale & Slavin, P.A.

(57) **CLAIM**
 The ornamental design for a refuse container, as shown and described.

DESCRIPTION

FIG. 1 is a top left perspective view of the refuse container of the present invention;
 FIG. 2 is a left side view thereof;
 FIG. 3 is a right side view thereof;
 FIG. 4 is a rear view thereof;
 FIG. 5 is a front view thereof;
 FIG. 6 is a top view thereof; and,
 FIG. 7 is a top right perspective view thereof.
 The portions of the refuse container illustrated in broken lines form no part of the claimed subject matter.

1 Claim, 7 Drawing Sheets

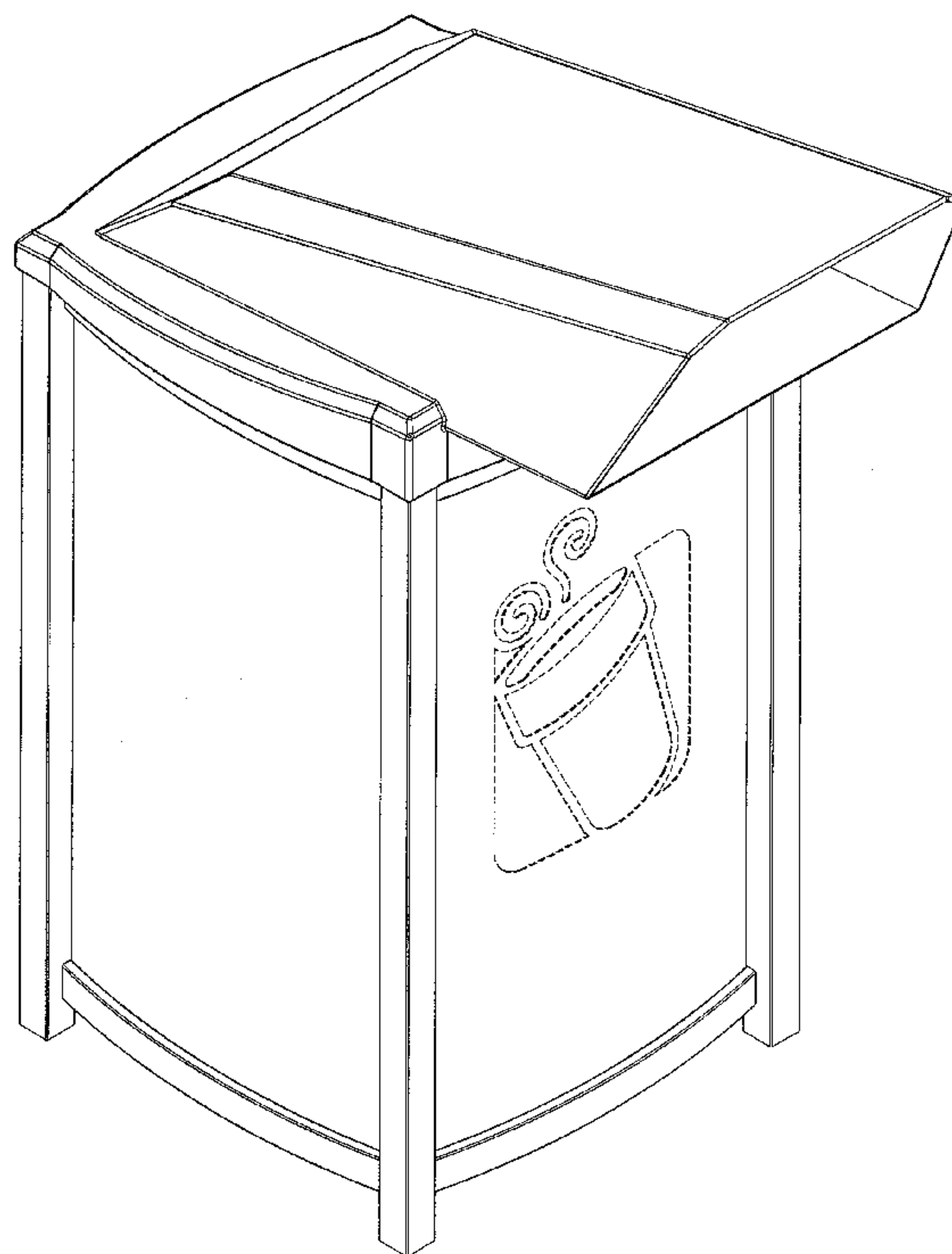

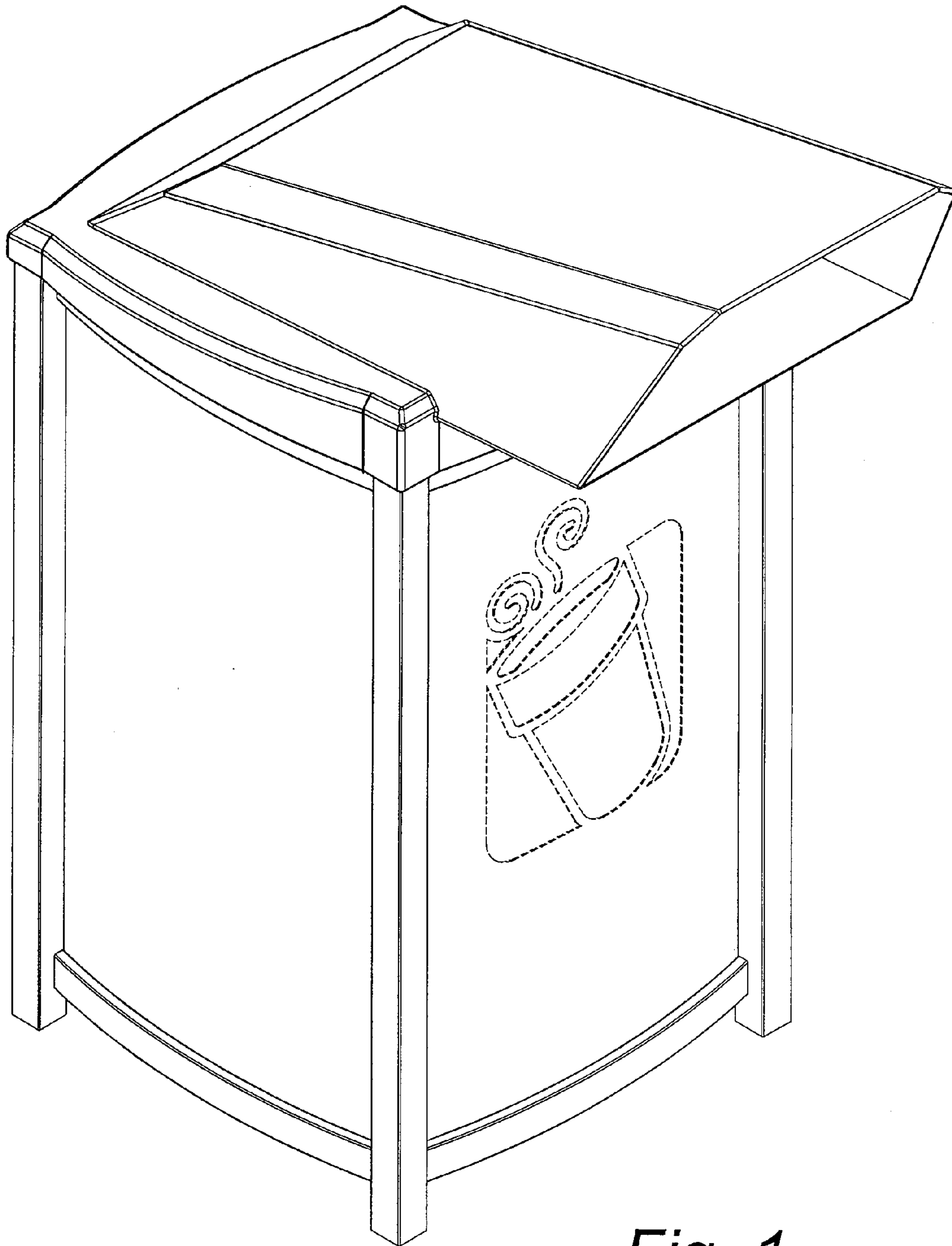

Fig. 1

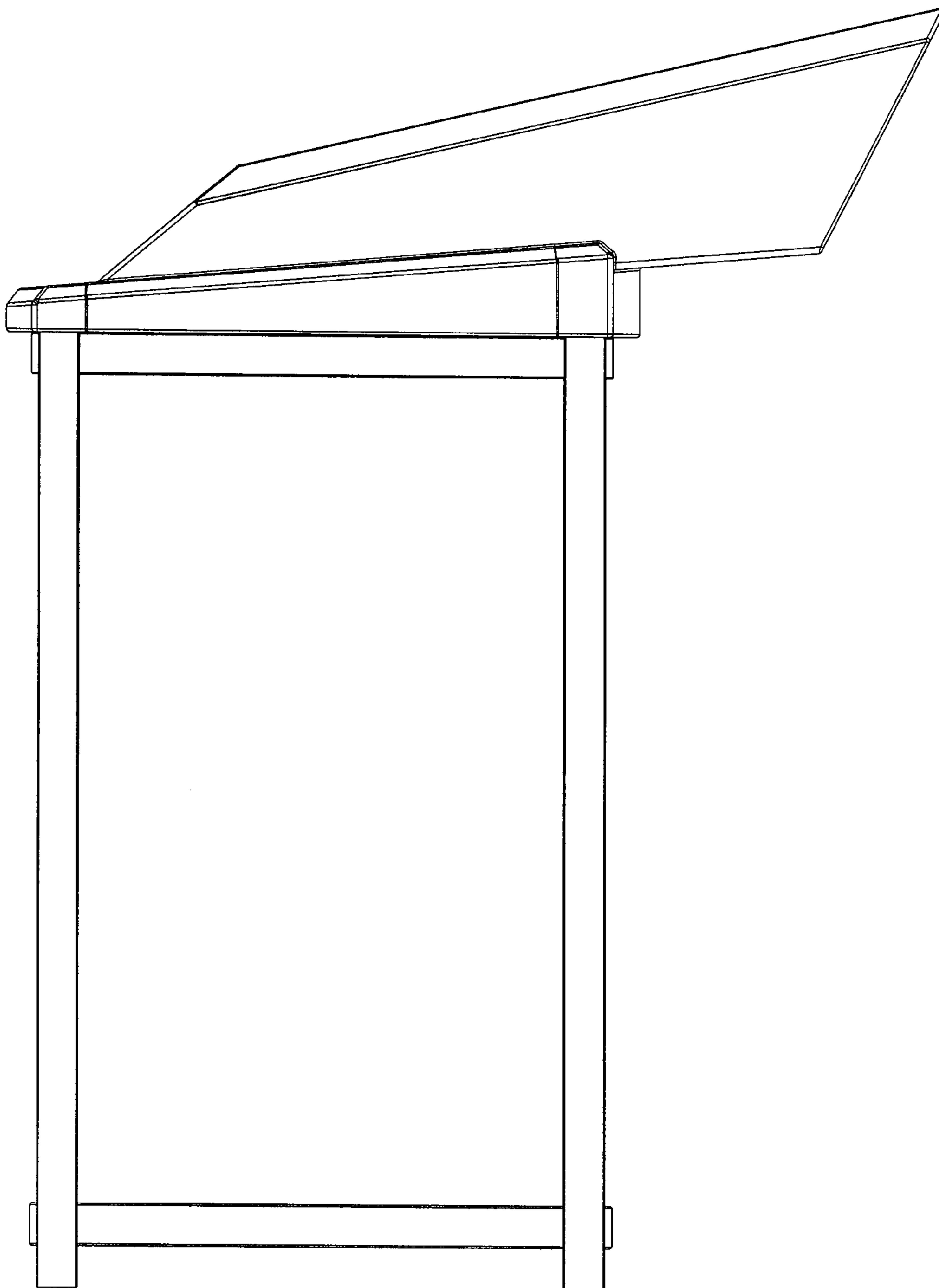

Fig. 2

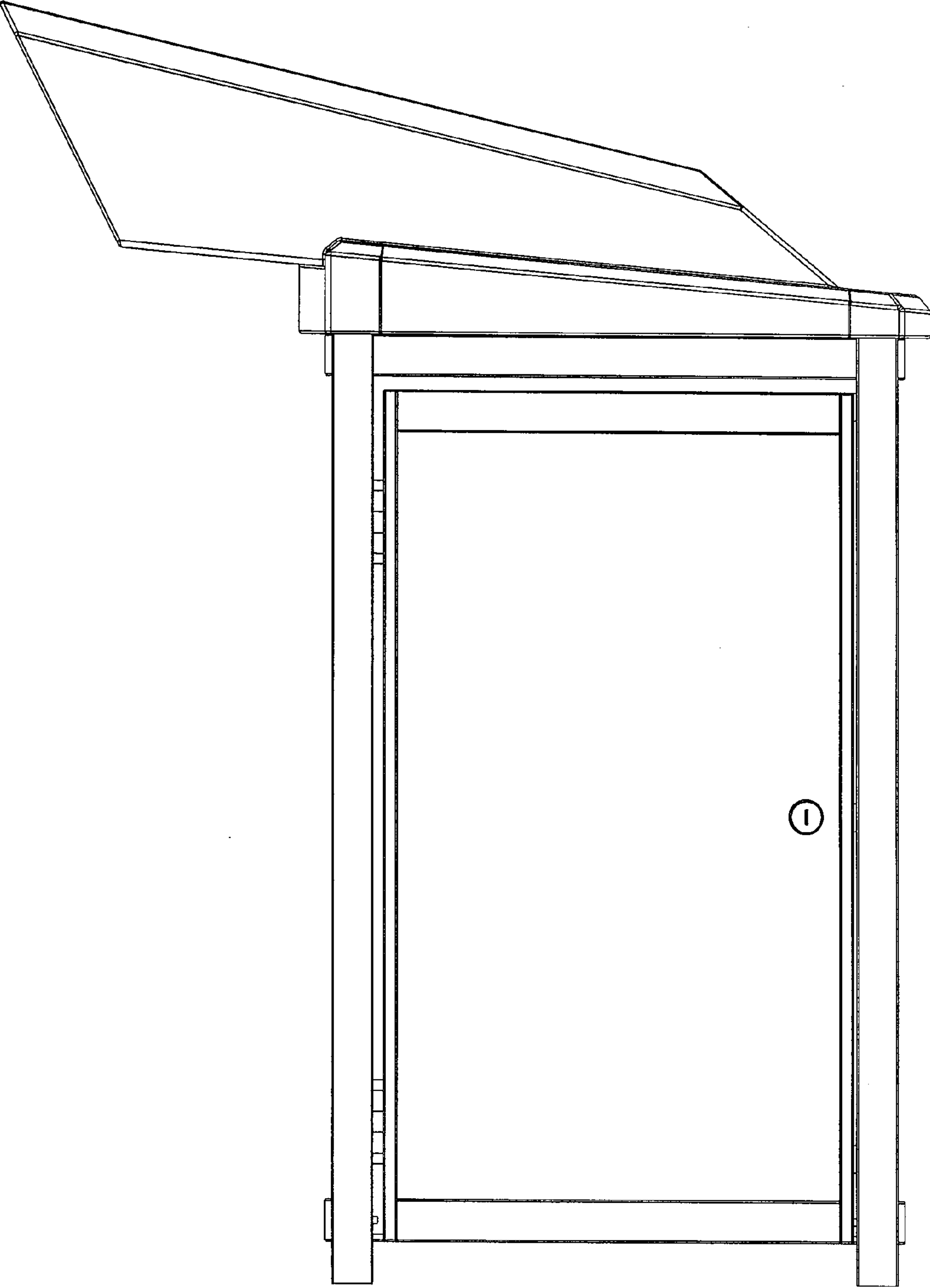

Fig. 3

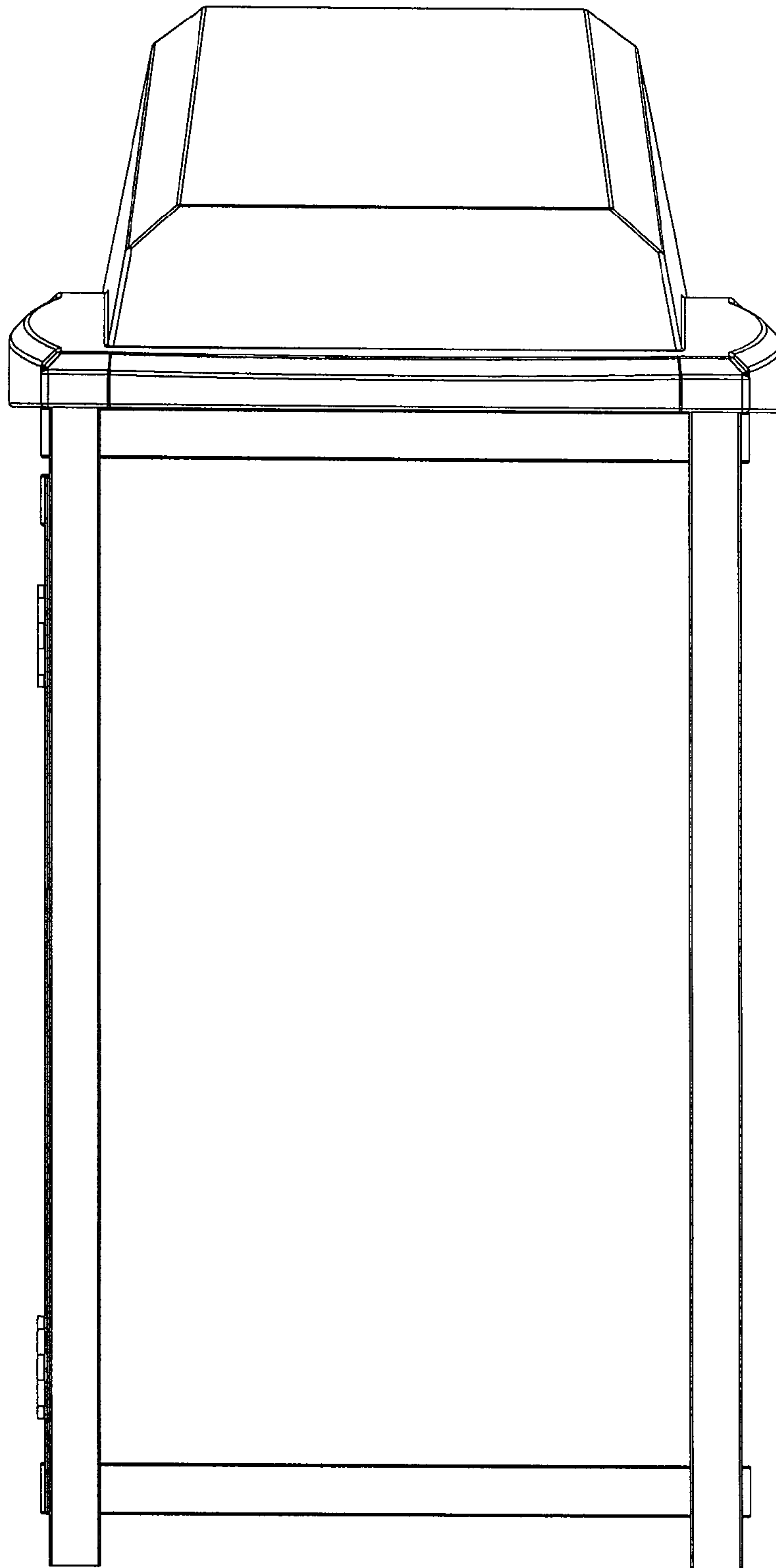

Fig. 4

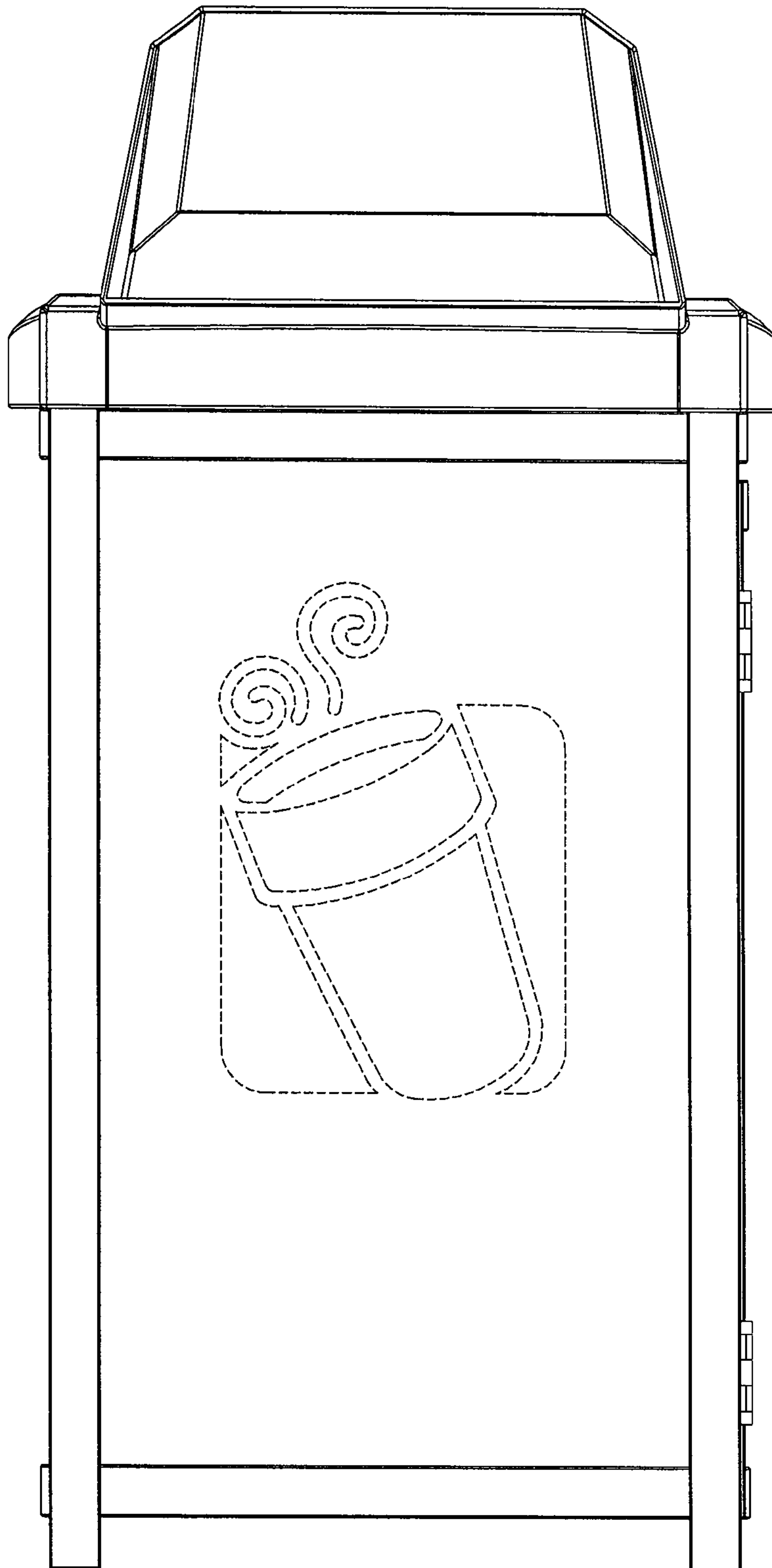

Fig. 5

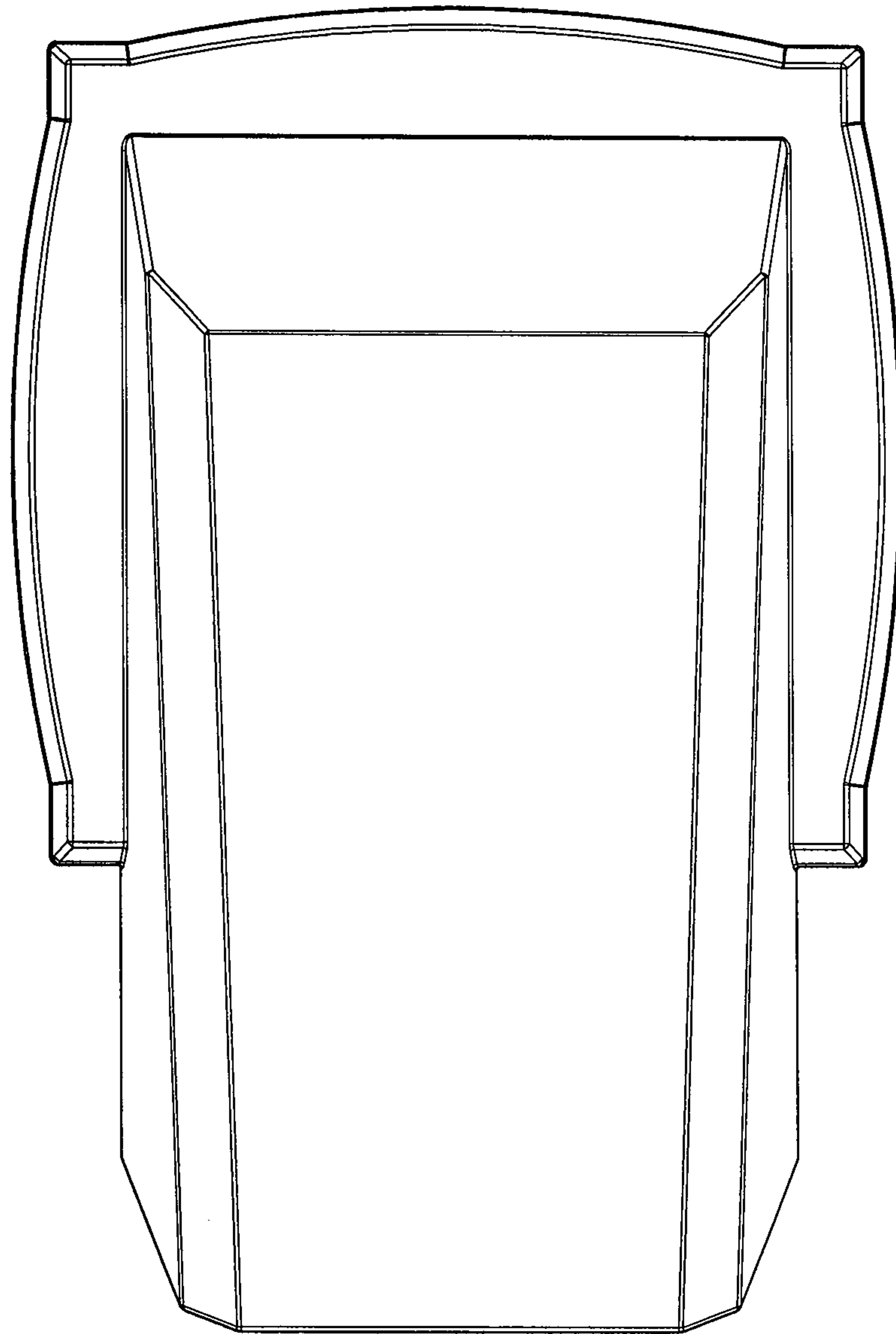

Fig. 6

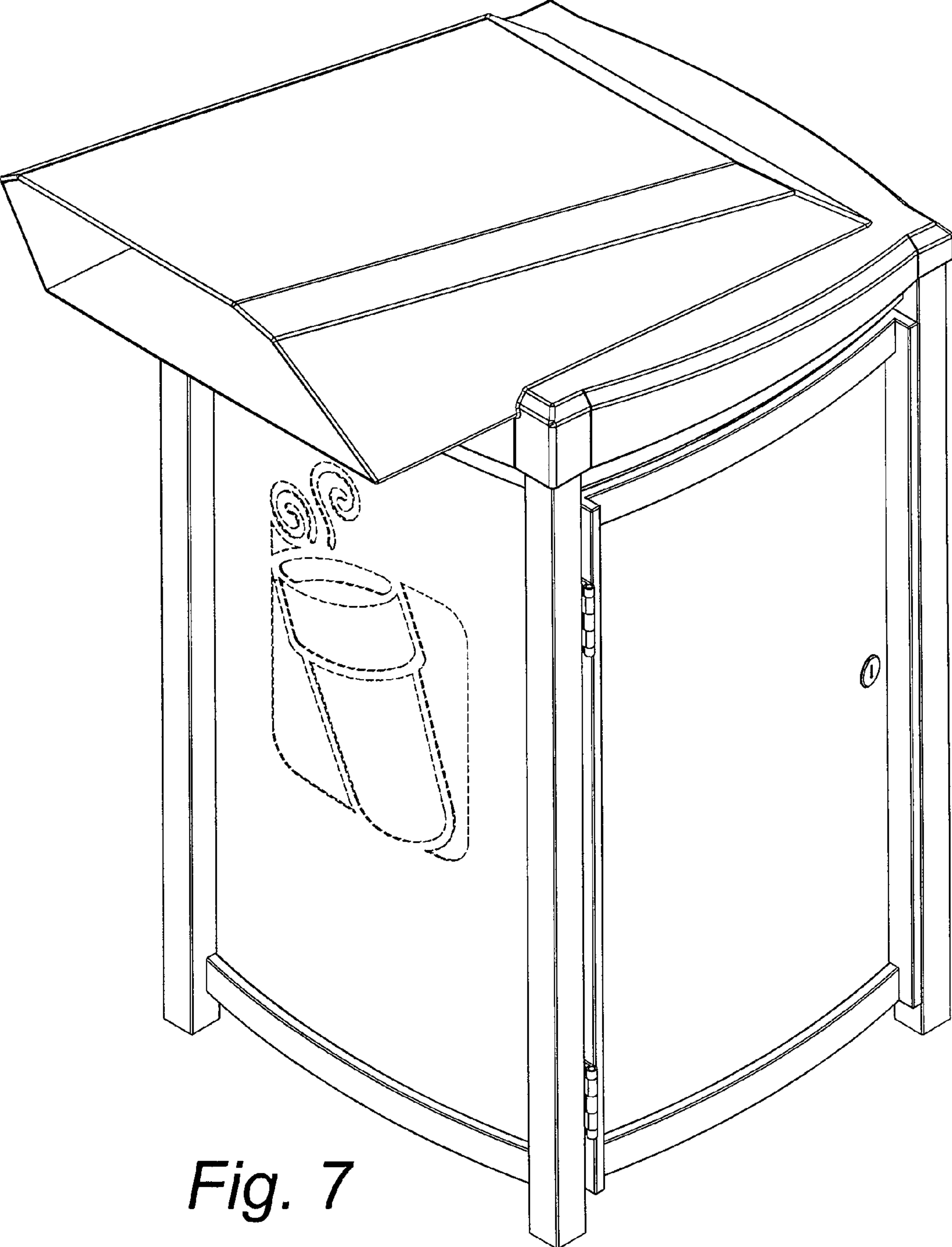

Fig. 7