



US00D766242S

(12) **United States Design Patent**
Moon et al.

(10) **Patent No.:** **US D766,242 S**

(45) **Date of Patent:** **** Sep. 13, 2016**

(54) **MOUSE FOR COMPUTER**

(71) Applicant: **LG ELECTRONICS INC.**, Seoul (KR)

(72) Inventors: **Yihyun Moon**, Seoul (KR); **Sungyong Park**, Seoul (KR)

(73) Assignee: **LG ELECTRONICS INC.**, Seoul (KR)

(**) Term: **15 Years**

(21) Appl. No.: **29/545,197**

(22) Filed: **Nov. 10, 2015**

(30) **Foreign Application Priority Data**

May 11, 2015 (KR) 30-2015-0023898

(51) **LOC (10) Cl.** **14-02**

(52) **U.S. Cl.**
USPC **D14/407**

(58) **Field of Classification Search**
USPC D14/402-411, 356, 388, 389, 383-385,
D14/417, 426; 345/156-167; 463/36-38;
358/471, 473; 273/148 B
CPC G06F 3/03543; G06F 2203/0333;
G06F 3/039; G06F 3/038; G06F 2203/0384
See application file for complete search history.

(56) **References Cited**

U.S. PATENT DOCUMENTS

D534,535 S * 1/2007 Tzeng D14/407
D545,822 S * 7/2007 Murakami D14/402

D575,784 S * 8/2008 Chatterjee D14/407
D581,929 S * 12/2008 Chatterjee D14/407
D583,377 S * 12/2008 Bradford D14/407
D590,399 S * 4/2009 Chen D14/402
D616,888 S * 6/2010 Chen D14/407
D643,429 S * 8/2011 Ferwerda D14/407
D647,093 S * 10/2011 Kim D14/407
D662,096 S * 6/2012 Yu D14/407
D684,973 S * 6/2013 Myung D14/407
D709,884 S * 7/2014 Shim D14/407
D715,801 S * 10/2014 Lee D14/407
D716,812 S * 11/2014 Lim D14/407
D753,659 S * 4/2016 Schoeck D14/407
D757,728 S * 5/2016 Schoeck D14/407
D757,729 S * 5/2016 Schoeck D14/407

* cited by examiner

Primary Examiner — Austin Murphy

(74) *Attorney, Agent, or Firm* — Birch, Stewart, Kolasch & Birch, LLP

(57) **CLAIM**

The ornamental design for a mouse for computer, as shown and described.

DESCRIPTION

FIG. 1 is a front, right side, perspective view of a mouse for computer showing our new design;
FIG. 2 is a front view thereof;
FIG. 3 is a rear view thereof;
FIG. 4 is a left side view thereof;
FIG. 5 is a right side view thereof;
FIG. 6 is a top view thereof; and,
FIG. 7 is a bottom view thereof.

1 Claim, 4 Drawing Sheets

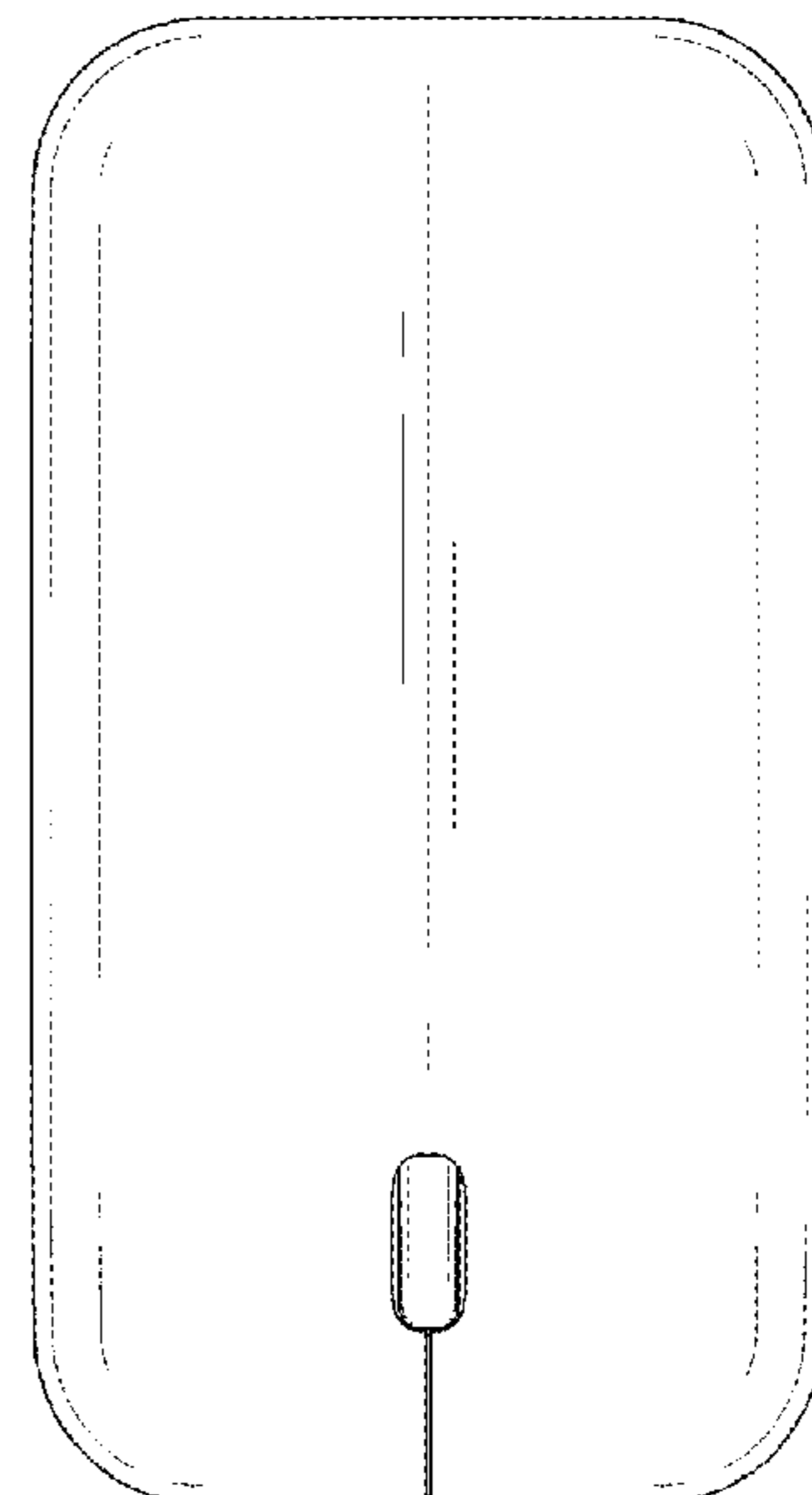
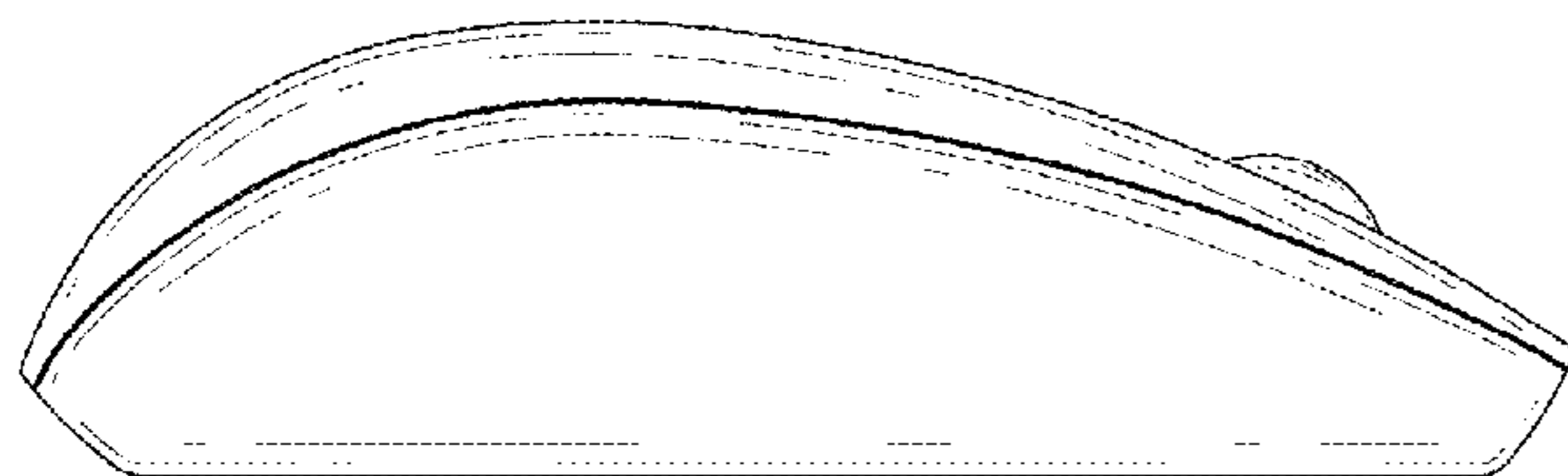

FIG. 1

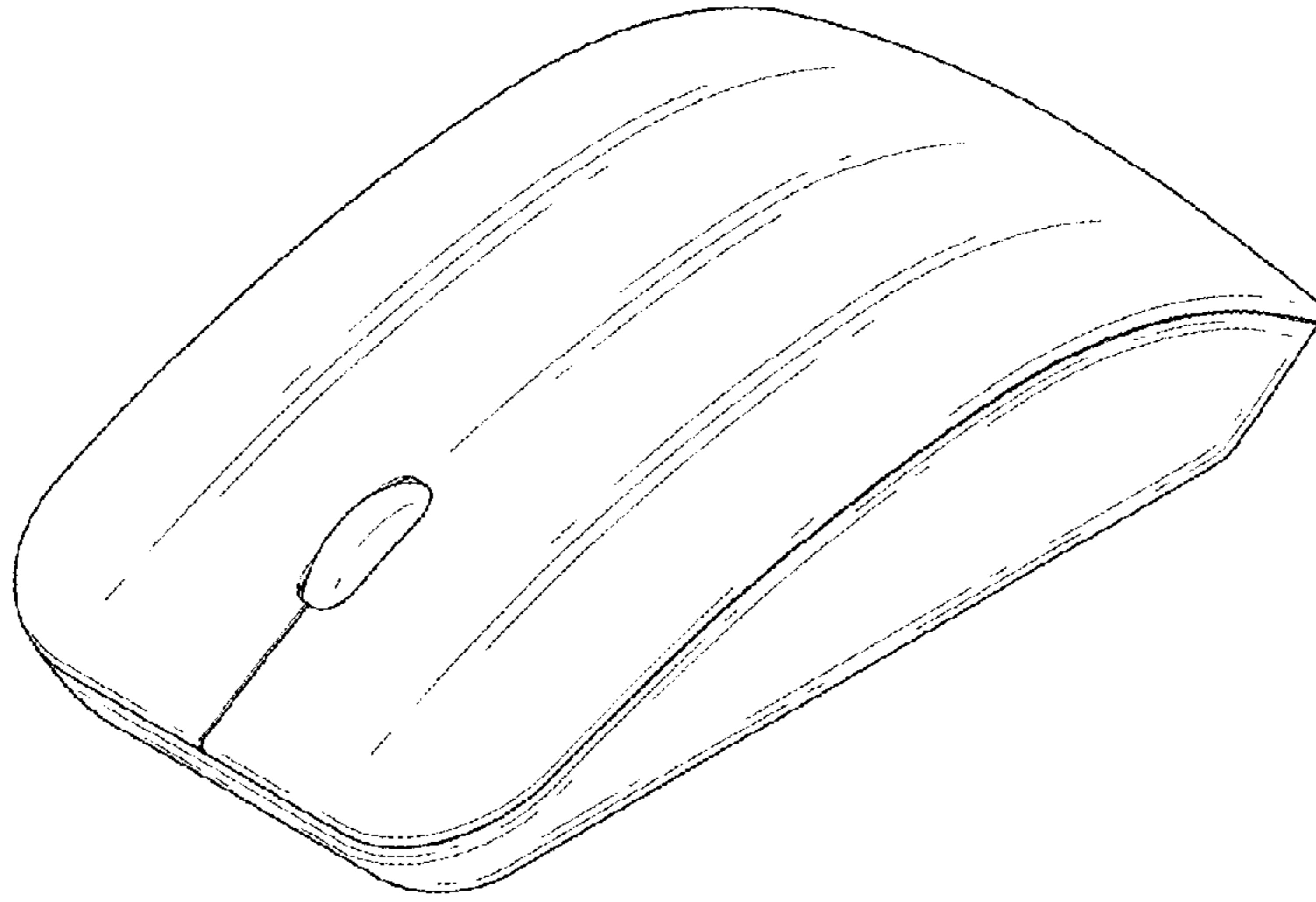

FIG. 2

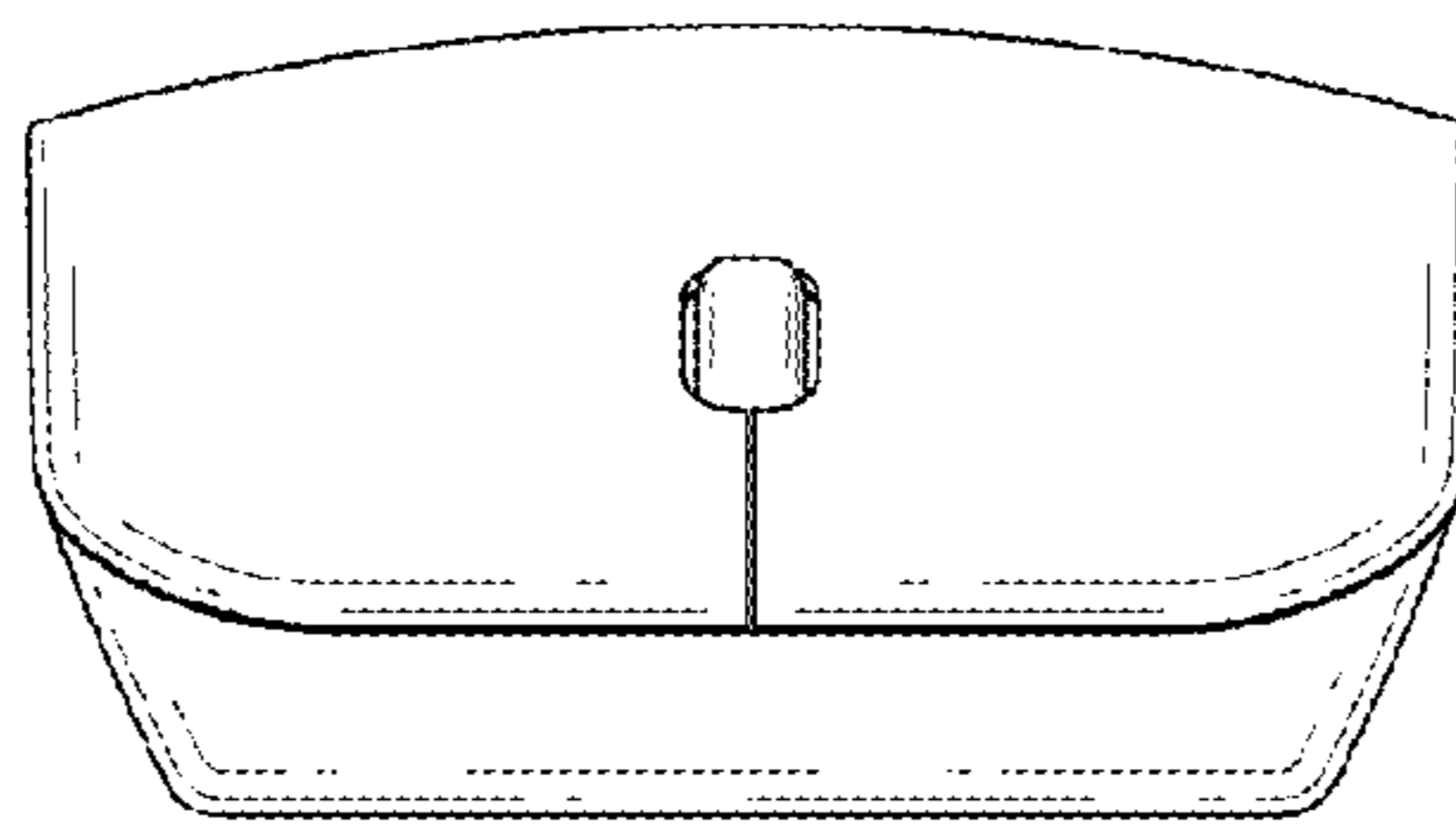

FIG. 3

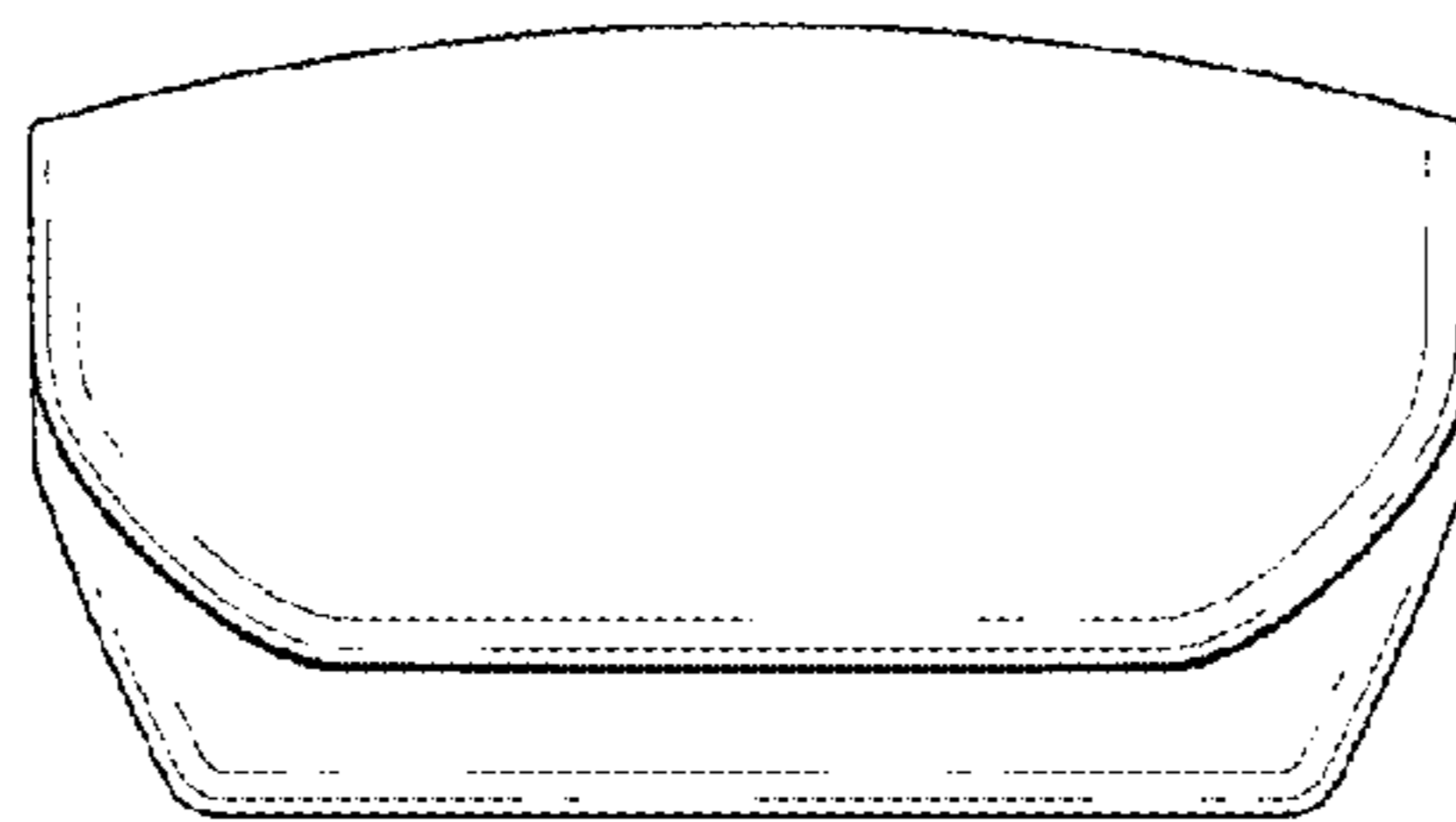

FIG. 4



FIG. 5

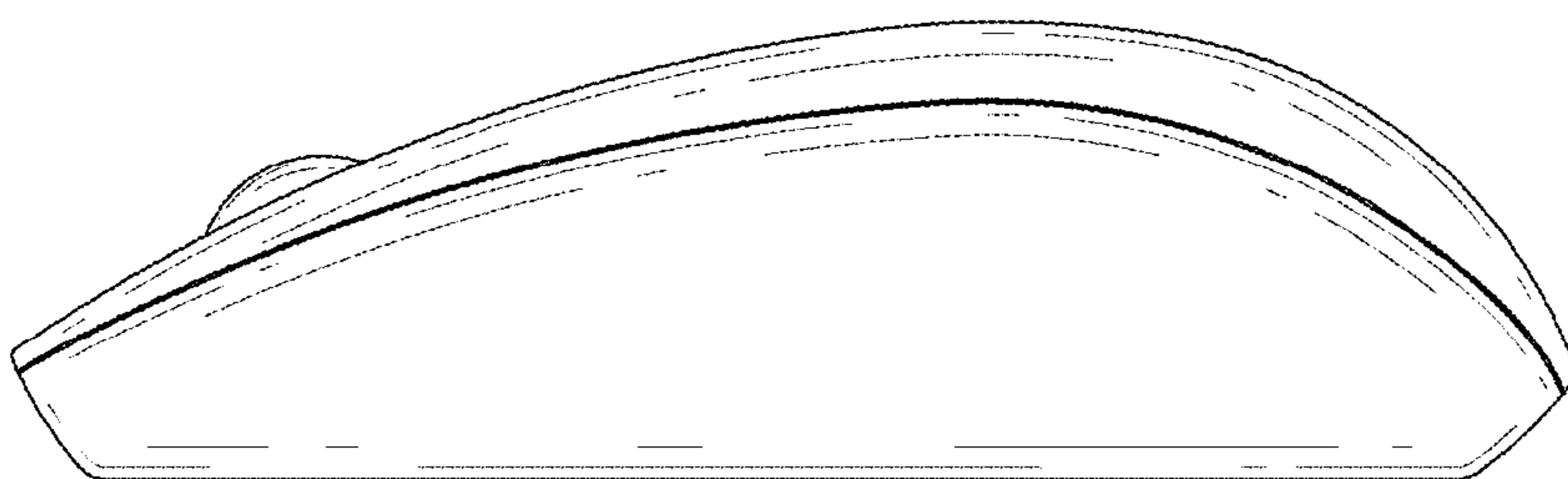

FIG. 6

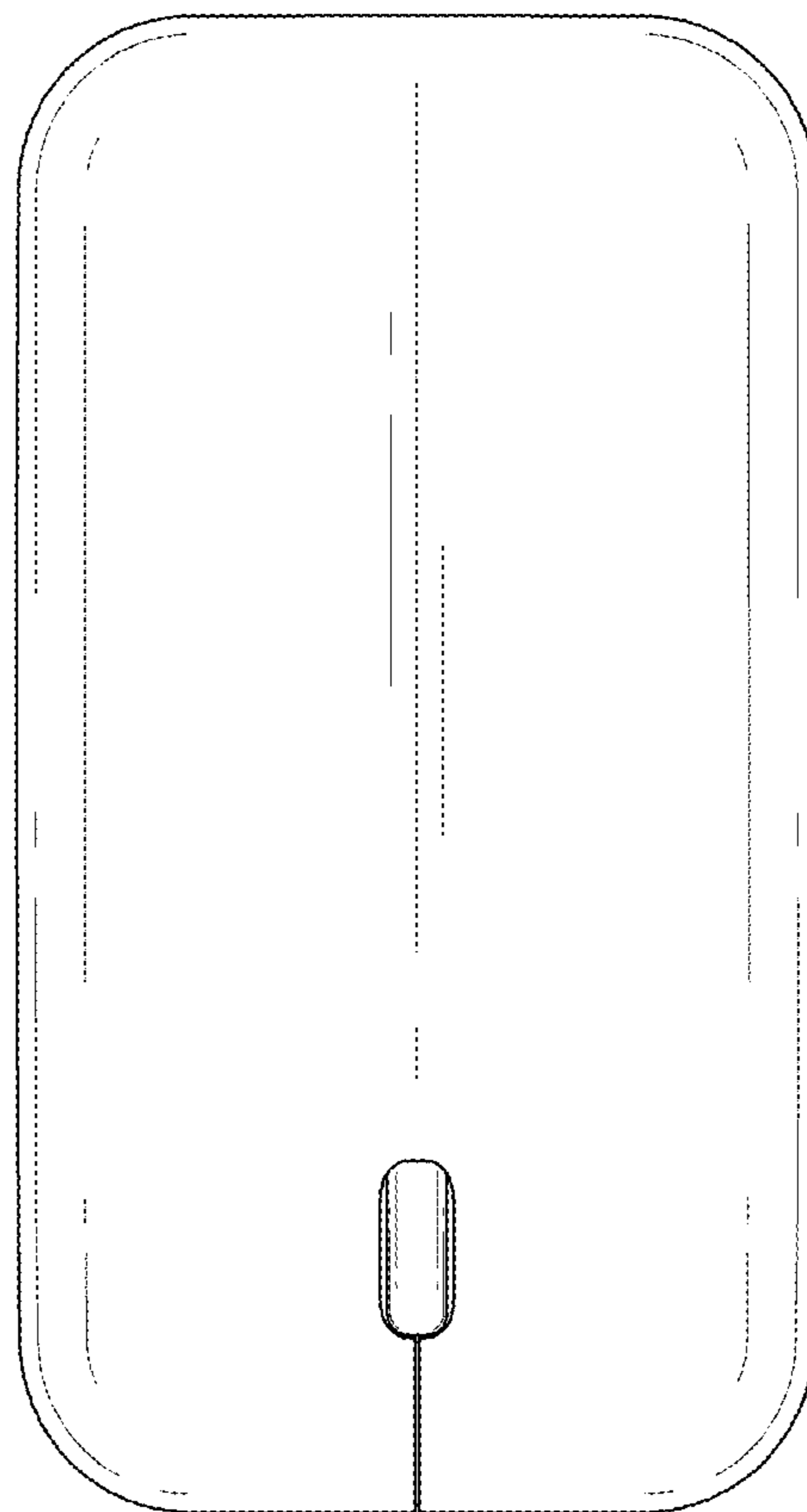

FIG. 7

