



US00D766233S

(12) **United States Design Patent** (10) **Patent No.:** **US D766,233 S**
Lam et al. (45) **Date of Patent:** **** Sep. 13, 2016**

(54) **ELECTRONIC DEVICE**

(56) **References Cited**

(71) Applicant: **Intel Corporation**, Santa Clara, CA (US)

U.S. PATENT DOCUMENTS

(72) Inventors: **Hue Lam**, Portland, OR (US); **George Daskalakis**, Forest Grove, OR (US); **Kimi Jensen**, Beaverton, OR (US); **Ky Nguyen**, Portland, OR (US)

5,103,376 A * 4/1992 Blonder G06F 1/1616
16/229
5,268,816 A * 12/1993 Abell, Jr. G06F 1/162
361/679.09
D346,591 S 5/1994 Lee
5,808,862 A 9/1998 Robbins
6,025,990 A 2/2000 Daskalakis et al.
6,167,613 B1 1/2001 Jarrett et al.
6,361,343 B1 3/2002 Daskalakis et al.
6,381,148 B1 4/2002 Daskalakis et al.
6,397,461 B1 6/2002 Jarrett et al.
D461,802 S 8/2002 Tu
D462,679 S 9/2002 Liu
6,551,120 B2 4/2003 Daskalakis et al.
D479,718 S 9/2003 Herrmann et al.
D504,889 S 5/2005 Andre et al.
7,002,795 B2 2/2006 Trautman et al.
D516,566 S 3/2006 Hsu
7,249,747 B2 7/2007 Marceau et al.
D551,670 S 9/2007 Ong et al.
7,280,347 B2 10/2007 Wong et al.
7,486,279 B2 2/2009 Wong et al.
7,626,358 B2 12/2009 Lam et al.
7,672,120 B2 3/2010 Kohlman et al.
7,969,117 B2 6/2011 Lam et al.
7,986,517 B2 * 7/2011 Jiang G06F 1/162
361/679.27

(73) Assignee: **Intel Corporation**, Santa Clara, CA (US)

(**) Term: **15 Years**

(21) Appl. No.: **29/535,050**

(22) Filed: **Aug. 3, 2015**

Related U.S. Application Data

(63) Continuation of application No. 29/441,013, filed on Dec. 29, 2012, now Pat. No. Des. 735,717.

(51) **LOC (10) Cl.** **14-02**

(52) **U.S. Cl.**
USPC **D14/315**

(58) **Field of Classification Search**
USPC D14/315-327; D18/1, 2, 7, 11;
235/145 A, 145 R; 341/22, 23; 345/104,
345/156, 168, 169, 173; 361/679.08,
361/679.09, 679.11, 679.26, 679.27
CPC G06F 1/16; G06F 1/1616; G06F 1/1626;
G06F 1/1632; G06F 1/1613; G06F 1/1601;
G06F 1/162; G06F 1/1654; G06F 1/1681;
G06F 1/1618; H01R 35/02; H03M 11/00;
G09B 13/04; H03K 17/94; G09G 5/00;
F16M 11/10; H05K 5/00; H04M 1/0237
See application file for complete search history.

D654,073 S 2/2012 Li
D684,155 S * 6/2013 Hsu D14/374
8,467,183 B2 6/2013 Probst et al.
8,472,186 B2 6/2013 Probst et al.
D685,783 S 7/2013 Bryan et al.
8,498,100 B1 7/2013 Whitt, III et al.
8,599,542 B1 * 12/2013 Healey G06F 1/1626
345/168
8,625,272 B2 1/2014 Huang et al.
D702,224 S * 4/2014 Matsuoka D14/315
D705,774 S * 5/2014 Hung D14/316
D734,319 S * 7/2015 Matsuoka D14/315
D735,717 S 8/2015 Lam et al.
2003/0112585 A1 6/2003 Silvester
2004/0169995 A1 9/2004 Ghosh et al.
2004/0174667 A1 9/2004 Kim et al.
2004/0228076 A1 11/2004 Clapper
2005/0162821 A1 7/2005 Homer et al.
2006/0038795 A1 2/2006 Lee
2007/0097087 A1 5/2007 Homer et al.
2011/0199727 A1 8/2011 Probst
2011/0267757 A1 11/2011 Probst et al.

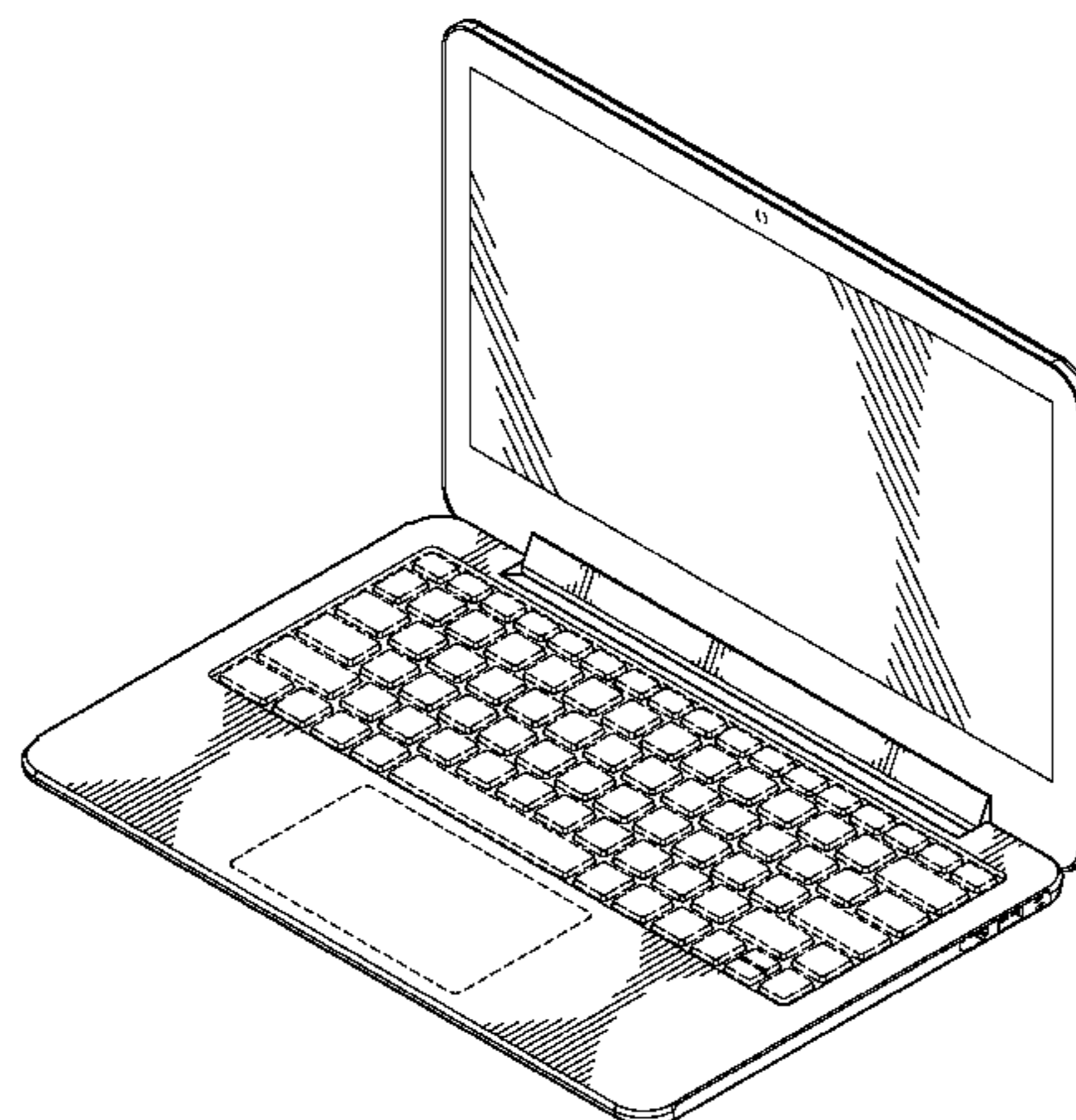

2012/0066424	A1*	3/2012	Gentil	G06F 1/1654 710/303
2012/0106059	A1	5/2012	Probst et al.	
2012/0106068	A1	5/2012	Huang et al.	
2013/0039000	A1*	2/2013	Vicente, Jr.	G06F 1/1681 361/679.41
2013/0170126	A1	7/2013	Lee	
2014/0002974	A1*	1/2014	Kuo	G06F 1/1632 361/679.01
2014/0169853	A1	6/2014	Sharma et al.	
2014/0184904	A1	7/2014	Lam et al.	

FOREIGN PATENT DOCUMENTS

CN	101095248	12/2007
CN	101287343	10/2008
CN	102622052	8/2012
CN	202533844	11/2012
TW	1292870	1/2008
TW	1328303	8/2010
TW	1329796	9/2010
TW	M418331	12/2011
TW	201249065	12/2012
WO	WO 2014/105193	A1 7/2014

OTHER PUBLICATIONS

USPTO Feb. 12, 2014 Nonfinal Rejection in U.S. Appl. No. 29/441,013, 6 pages.
 International Search Report and Written Opinion received for PCT Patent Application No. PCT/US2013/048285, mailed on Sep. 27, 2013, 10 pages.
 Lenovo IdeaPad Yoga 13 User Guide V1.0, Jul. 2012, 39 pages.
 USPTO Aug. 29, 2014 Nonfinal Rejection in U.S. Appl. No. 13/730,969, 13 pages.
 USPTO Nov. 28, 2014 Nonfinal Rejection in U.S. Appl. No. 29/441,013, 14 pages.
 USPTO Mar. 12, 2015 Final Rejection in U.S. Appl. No. 13/730,969, 14 pages.
 USPTO Apr. 2, 2015 Notice of Allowance in U.S. Appl. No. 29/441,013, 7 pages.
 International Preliminary Report on Patentability received for PCT Patent Application No. PCT/US2013/048285, mailed on Jul. 9, 2015, 9 pages.
 USPTO Notice of Allowance in U.S. Appl. No. 13/730,969 mailed Sep. 17, 2015.
 Official Letter dated Oct. 22, 2015 for R.O.C. Patent Application No. 102146941; English Translation.
 Search Report of R.O.C. Patent Application No. 102146941 completed Oct. 14, 2015; English translation.

* cited by examiner

Primary Examiner — Freda S Nunn
 (74) Attorney, Agent, or Firm — Patent Capital Group

(57) **CLAIM**
 The ornamental design for an electronic device, as shown and described.

DESCRIPTION

FIG. 1 is a perspective view of an electronic device shown in an opened position;
 FIG. 2 is a front view thereof;
 FIG. 3 is a back view thereof;
 FIG. 4 is a side view thereof;
 FIG. 5 is another side view thereof;
 FIG. 6 is a top view thereof;
 FIG. 7 is a bottom view thereof;
 FIG. 8 is a perspective view thereof wherein the hinge is shown in an alternate position and the display panel is shown detached from the base and inverted allowing the device to be used as a tablet;
 FIG. 9 is a front view thereof;
 FIG. 10 is a back view thereof;
 FIG. 11 is a side view thereof;
 FIG. 12 is another side view thereof;
 FIG. 13 is a top view thereof;
 FIG. 14 is a bottom view thereof;
 FIG. 15 is a perspective view thereof in a closed position;
 FIG. 16 is a front view thereof;
 FIG. 17 is a back view thereof;
 FIG. 18 is a side view thereof;
 FIG. 19 is another side view thereof;
 FIG. 20 is a top view thereof;
 FIG. 21 is a bottom view thereof;
 FIG. 22 is a perspective view of the display panel thereof shown separately for clarity of illustration only;
 FIG. 23 is a front view thereof;
 FIG. 24 is a back view thereof;
 FIG. 25 is a side view thereof;
 FIG. 26 is another side view thereof;
 FIG. 27 is a top view thereof;
 FIG. 28 is a bottom view thereof;
 FIG. 29 is another perspective view thereof;
 FIG. 30 is a perspective view of the base thereof shown separately for clarity of illustration only;
 FIG. 31 is a front view thereof;
 FIG. 32 is a back view thereof;
 FIG. 33 is a side view thereof;
 FIG. 34 is another side view thereof;
 FIG. 35 is a top view thereof; and,
 FIG. 36 is a bottom view thereof.
 The broken lines shown in the figures represent unclaimed portions of the electronic device and form no part of the claimed design.

1 Claim, 26 Drawing Sheets

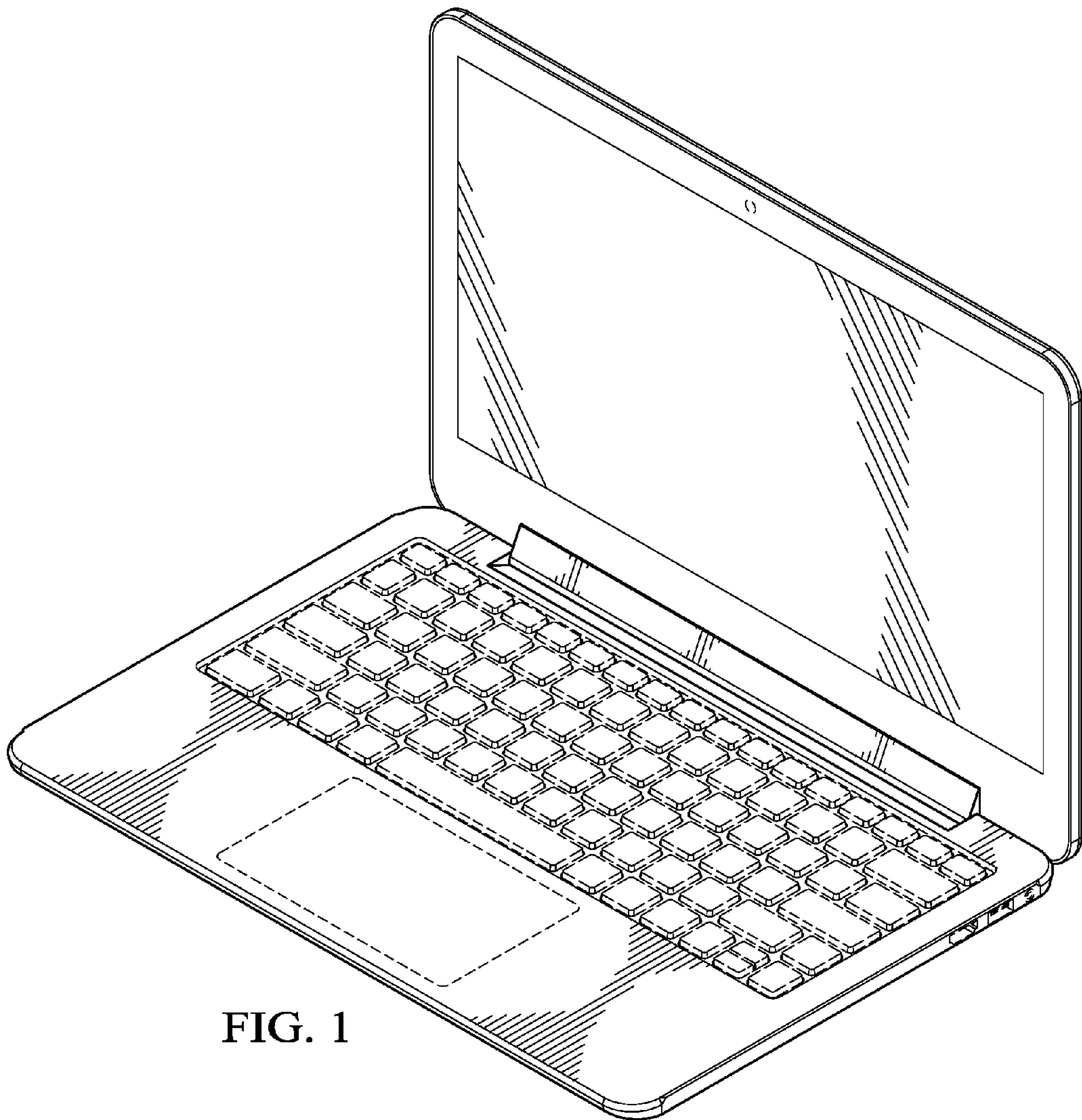

FIG. 1

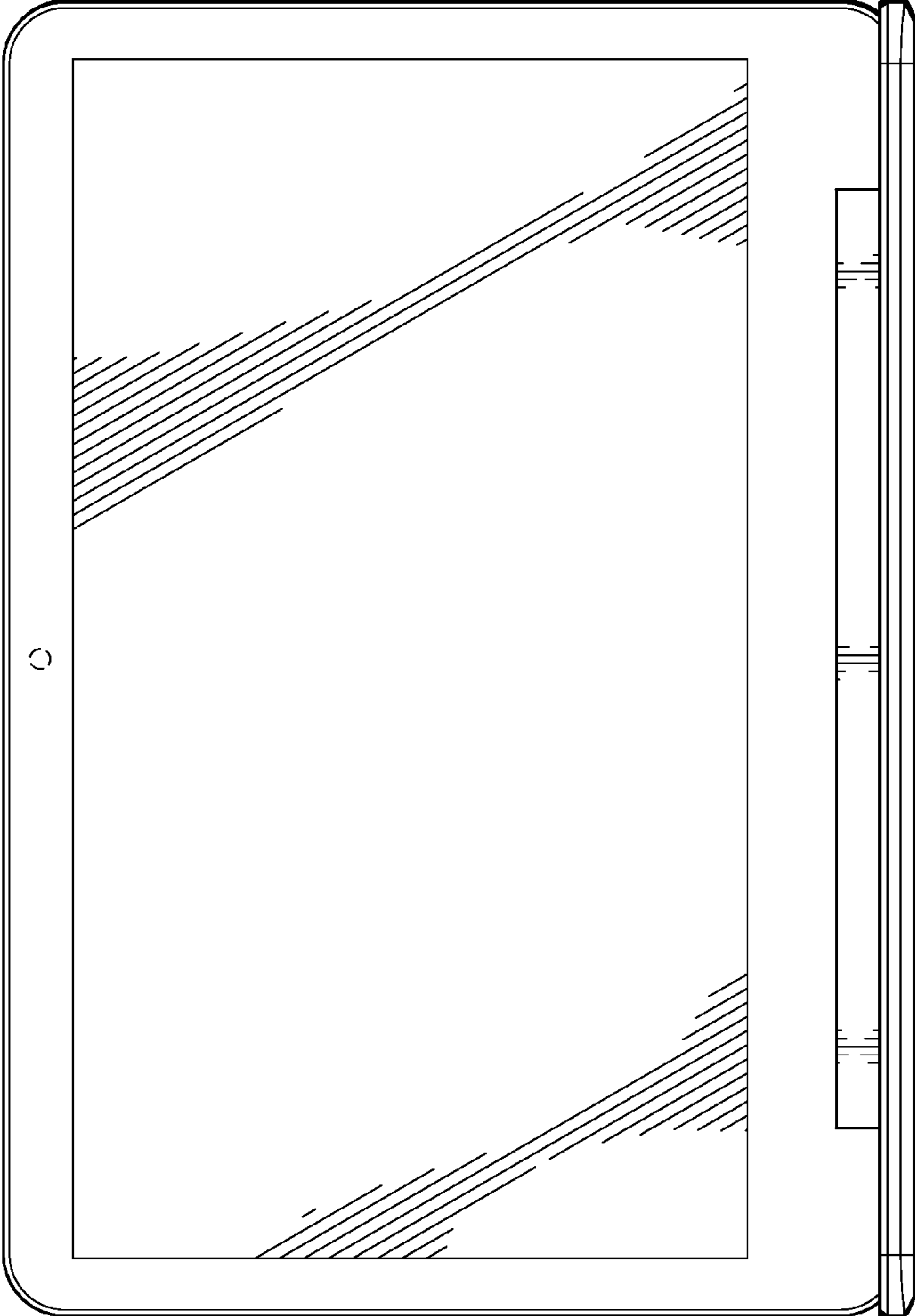

FIG. 2

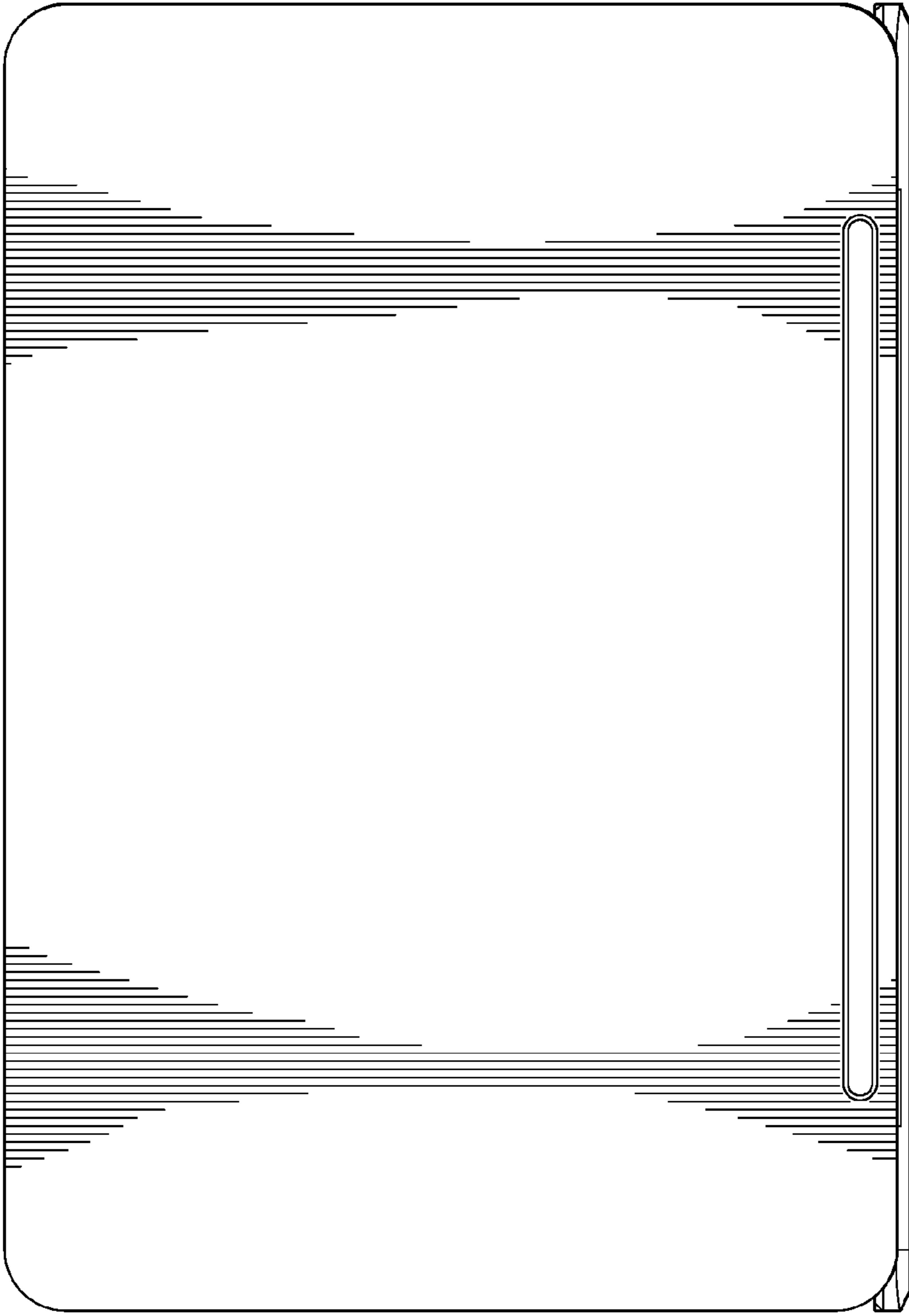

FIG. 3

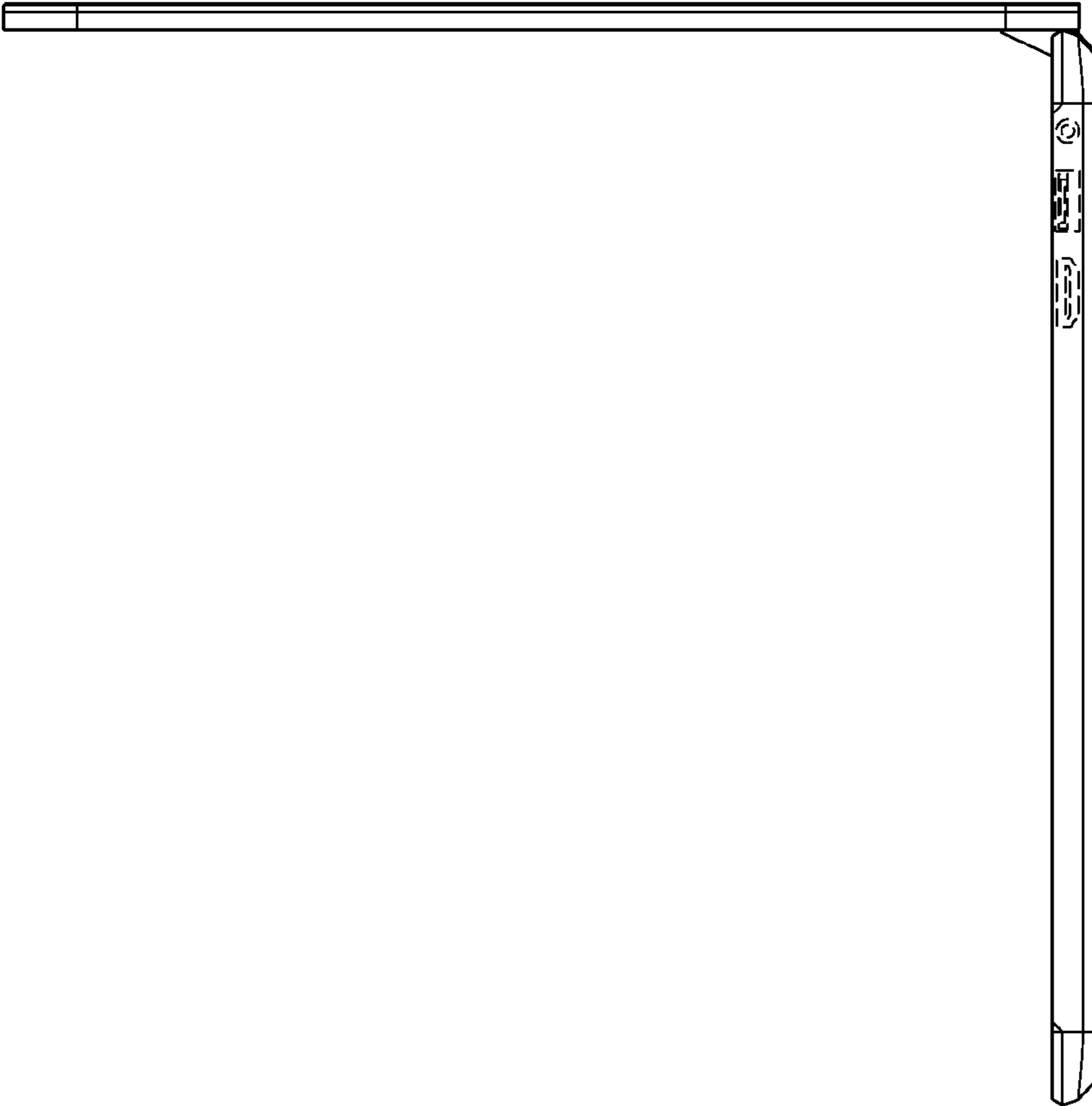

FIG. 4

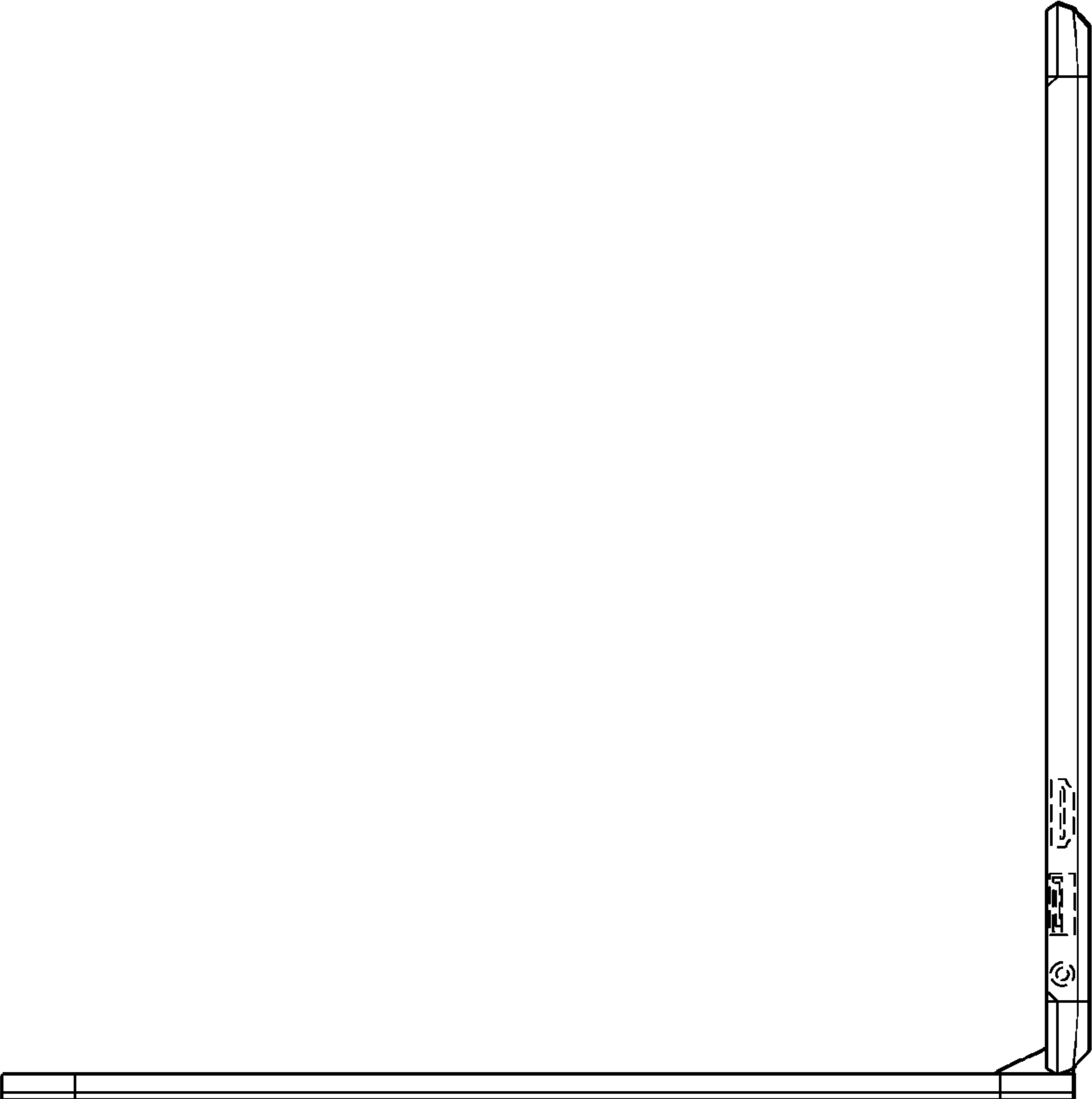

FIG. 5

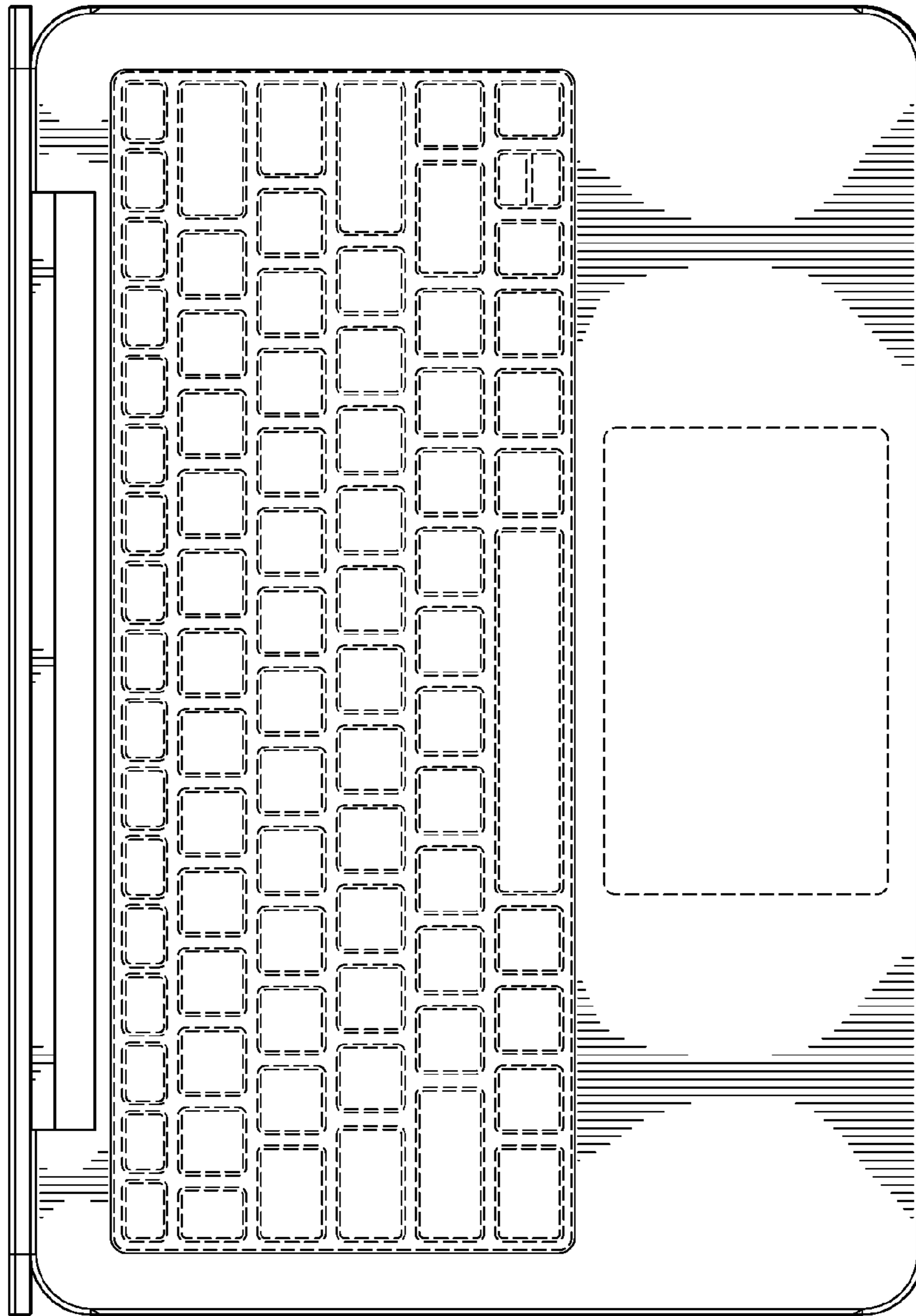

FIG. 6

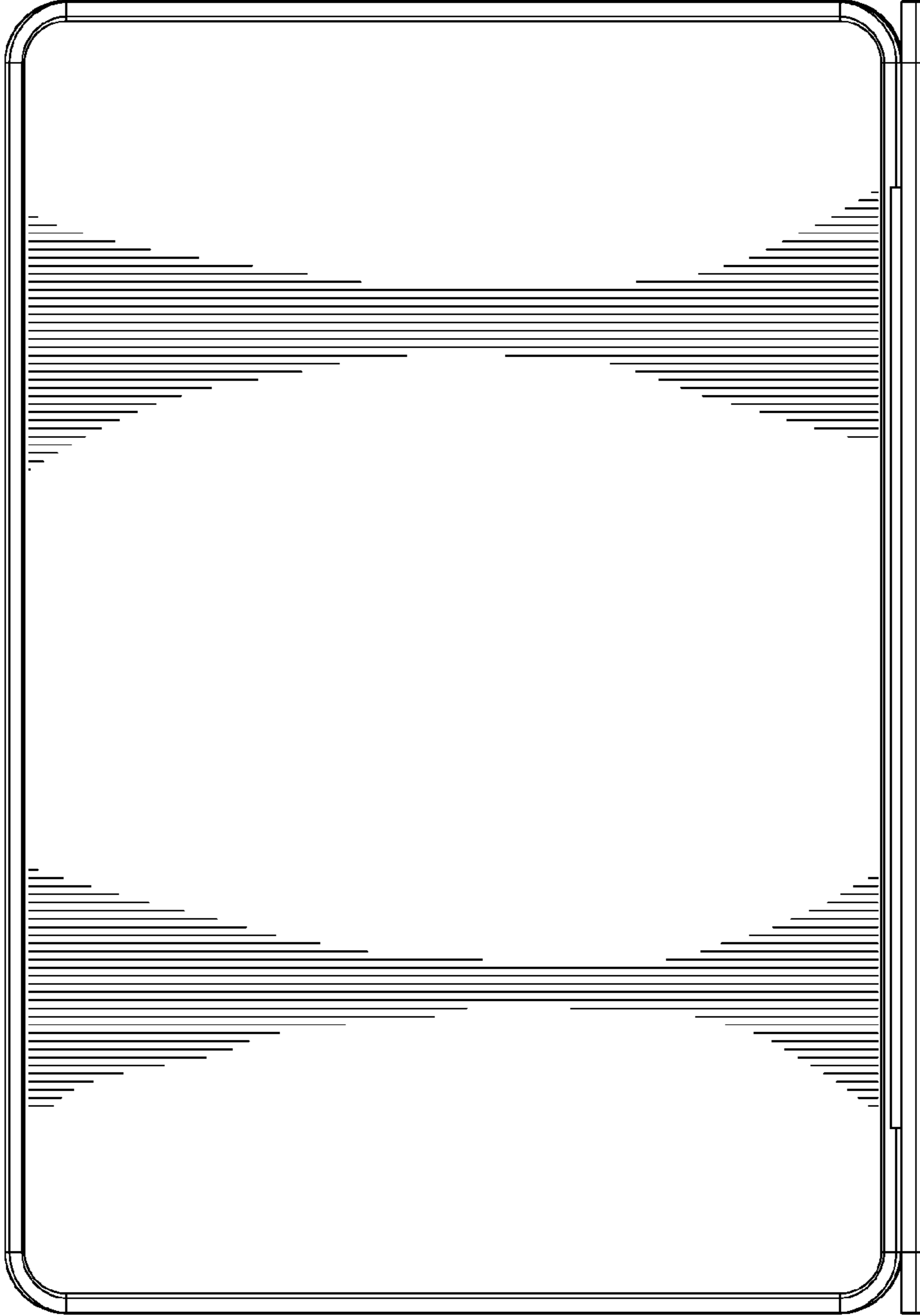

FIG. 7

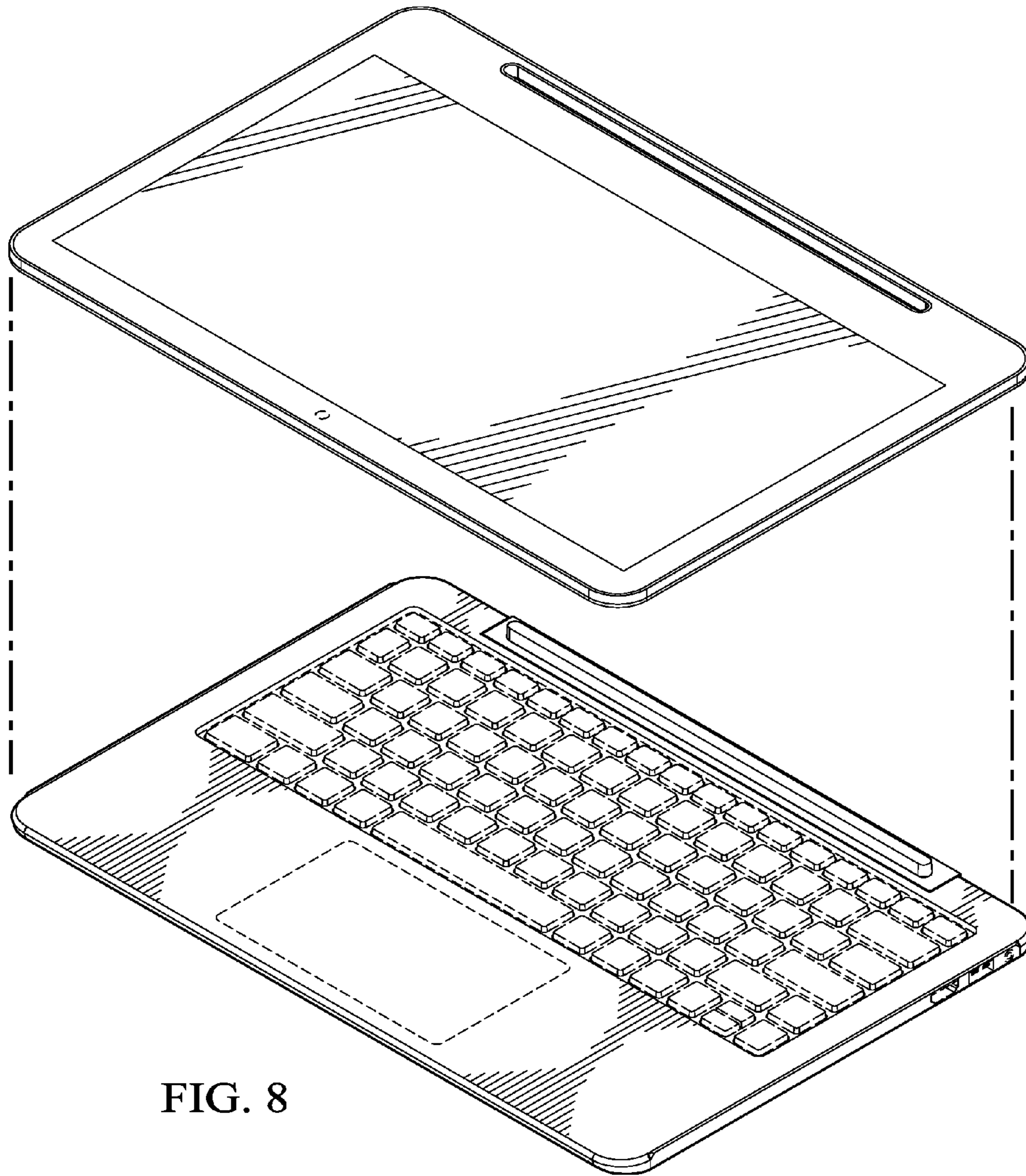

FIG. 8

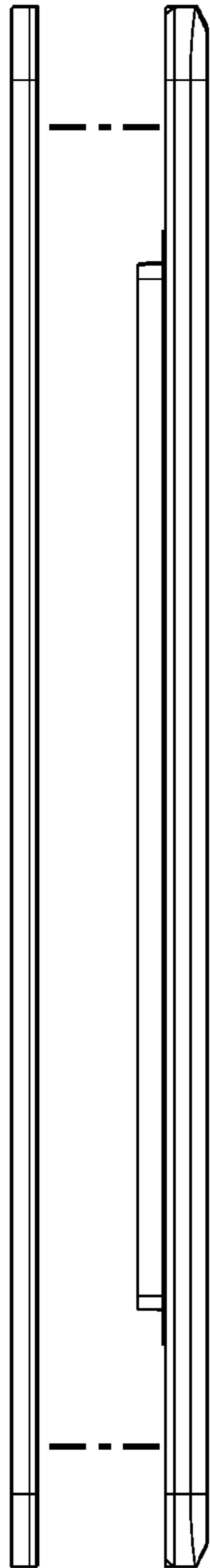

FIG. 9

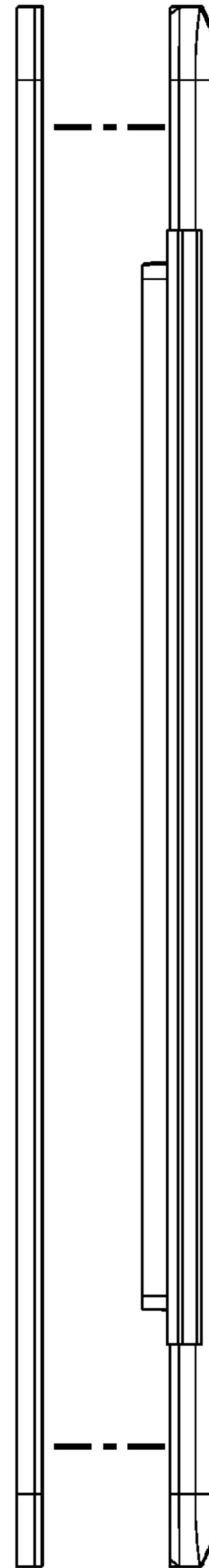

FIG. 10

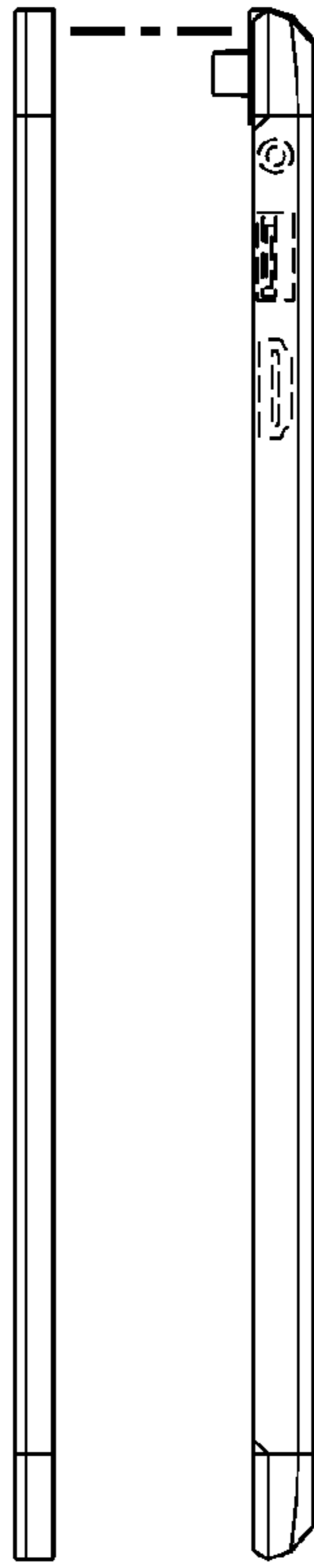

FIG. 11

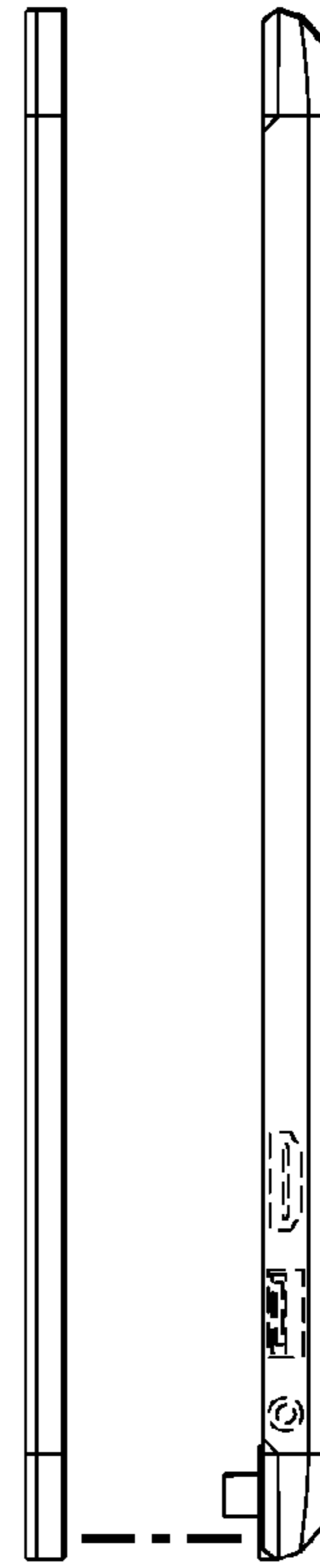

FIG. 12

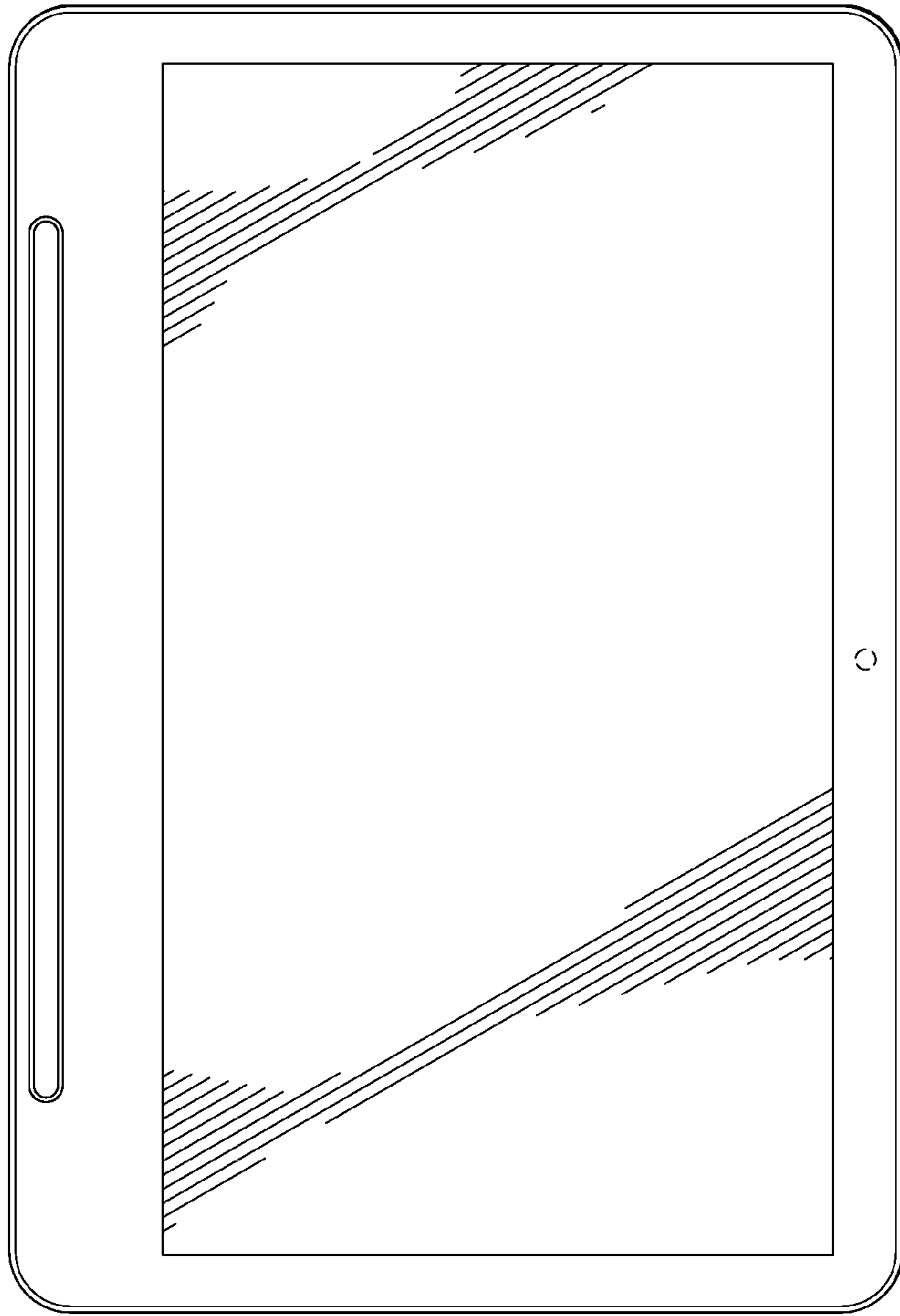

FIG. 13

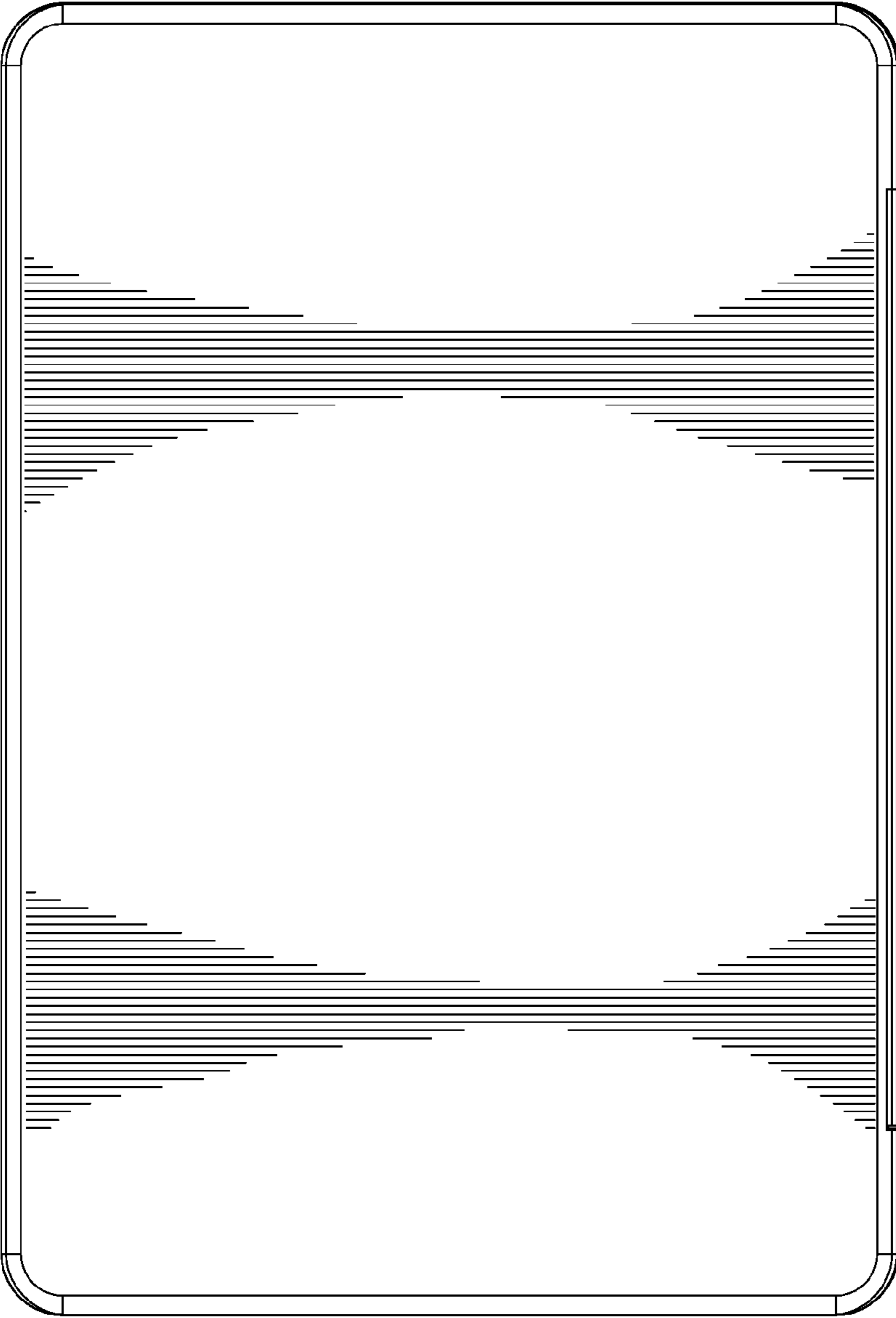

FIG. 14

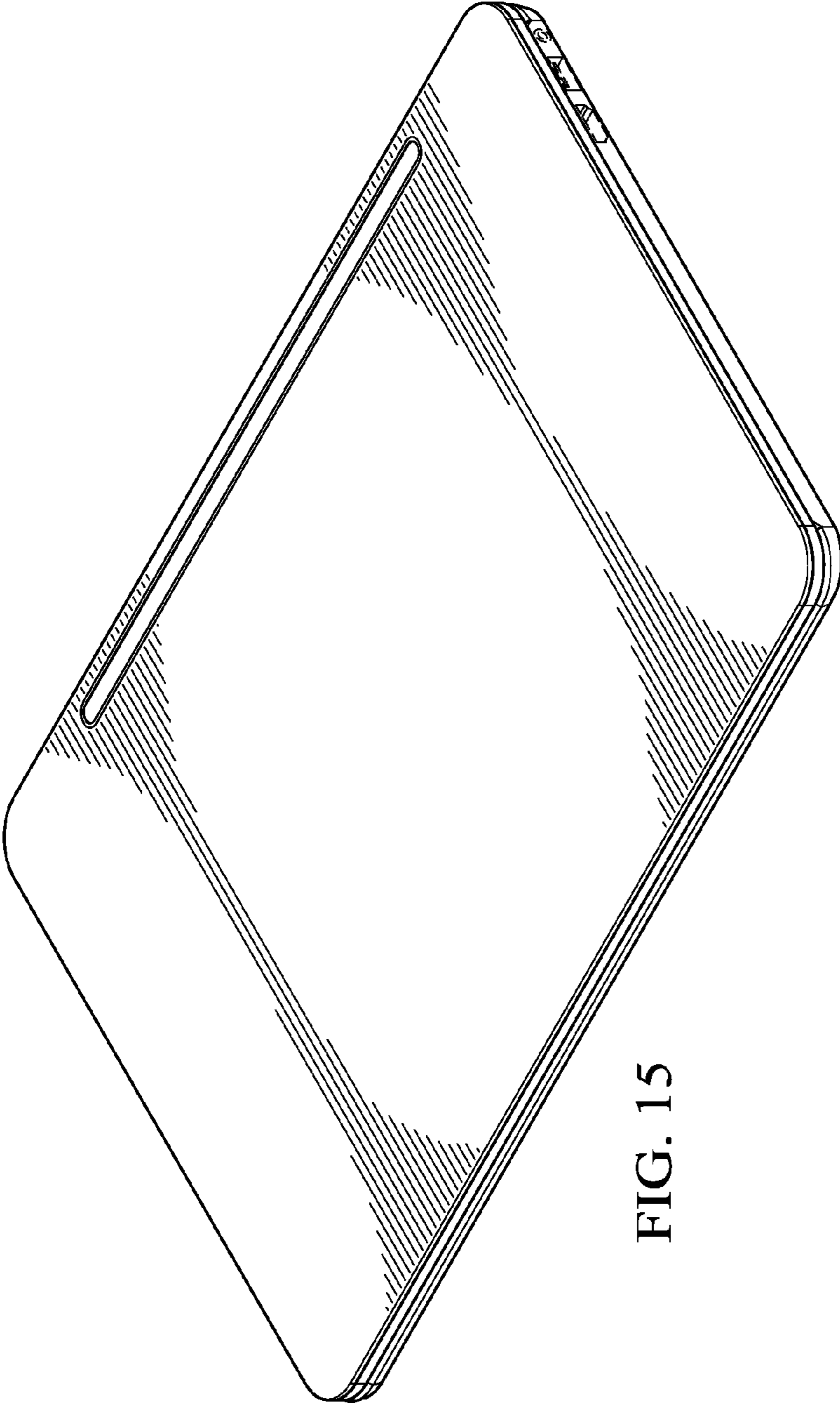

FIG. 15



FIG. 16



FIG. 17



FIG. 18

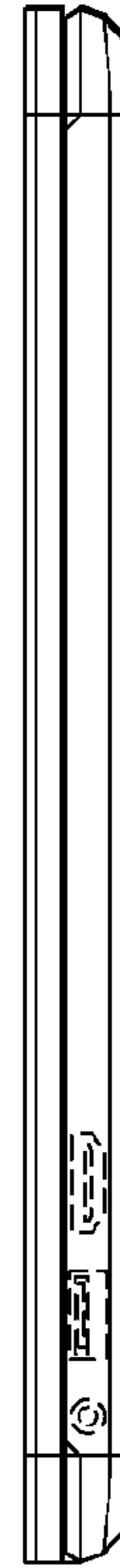

FIG. 19

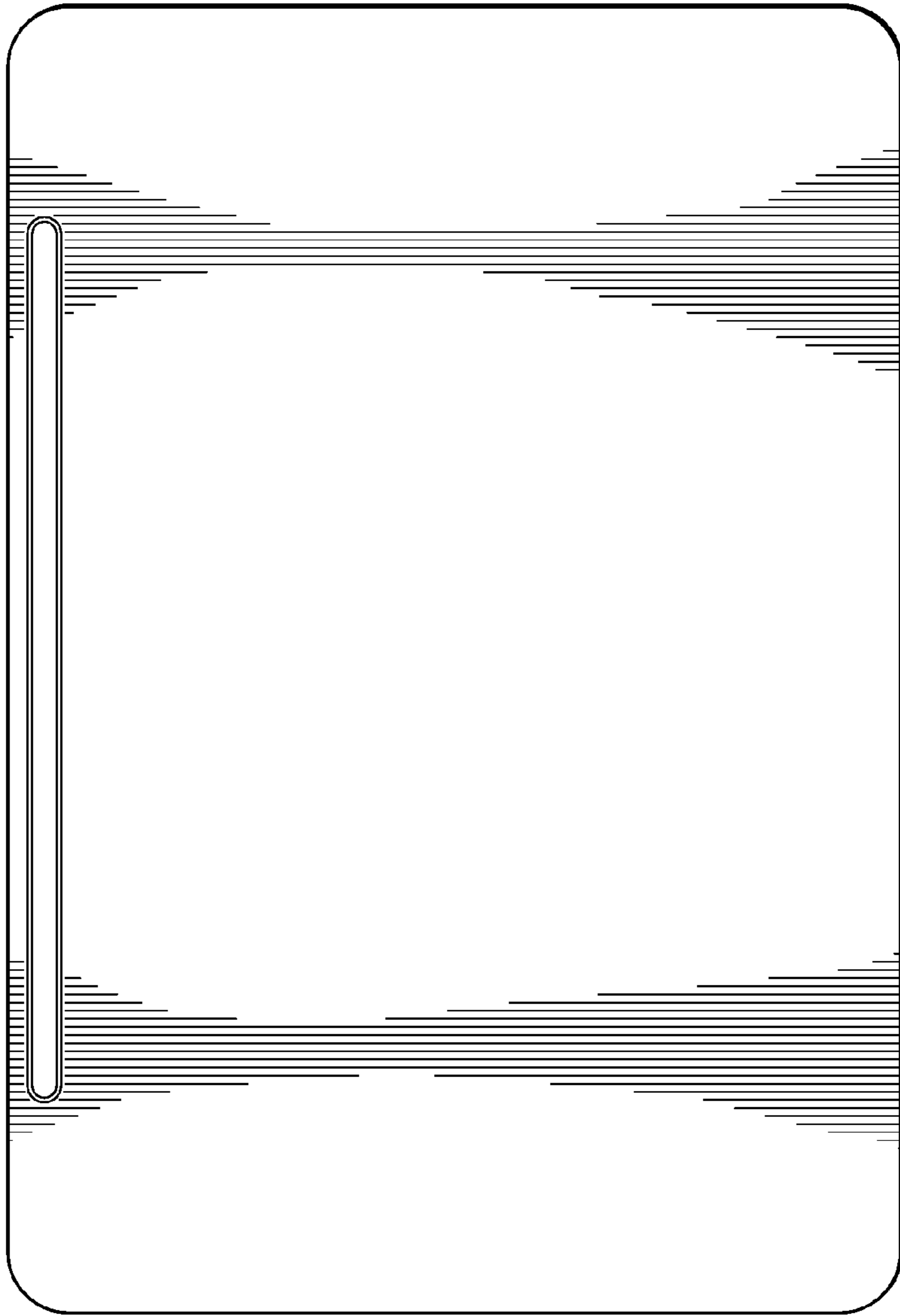

FIG. 20

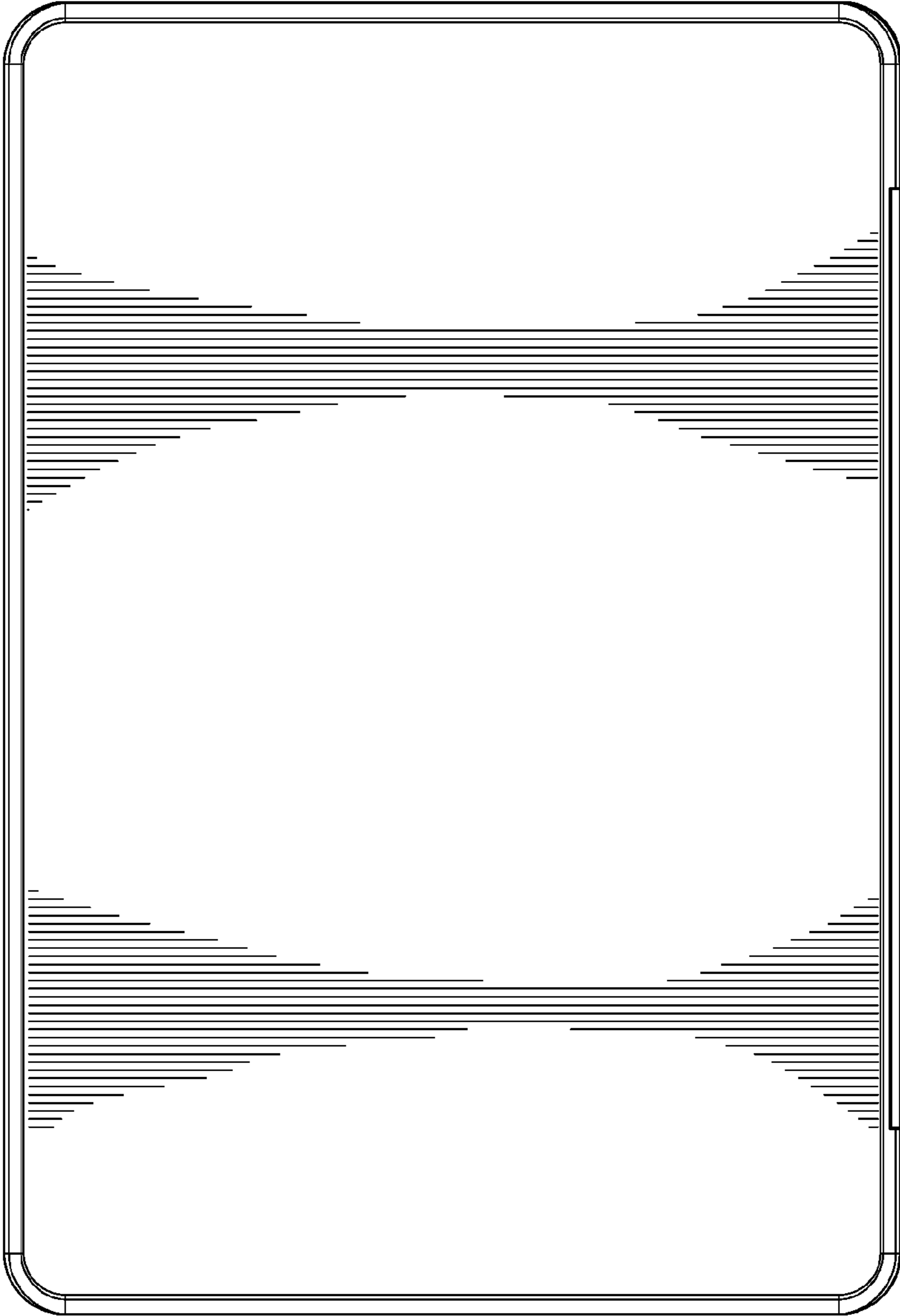

FIG. 21

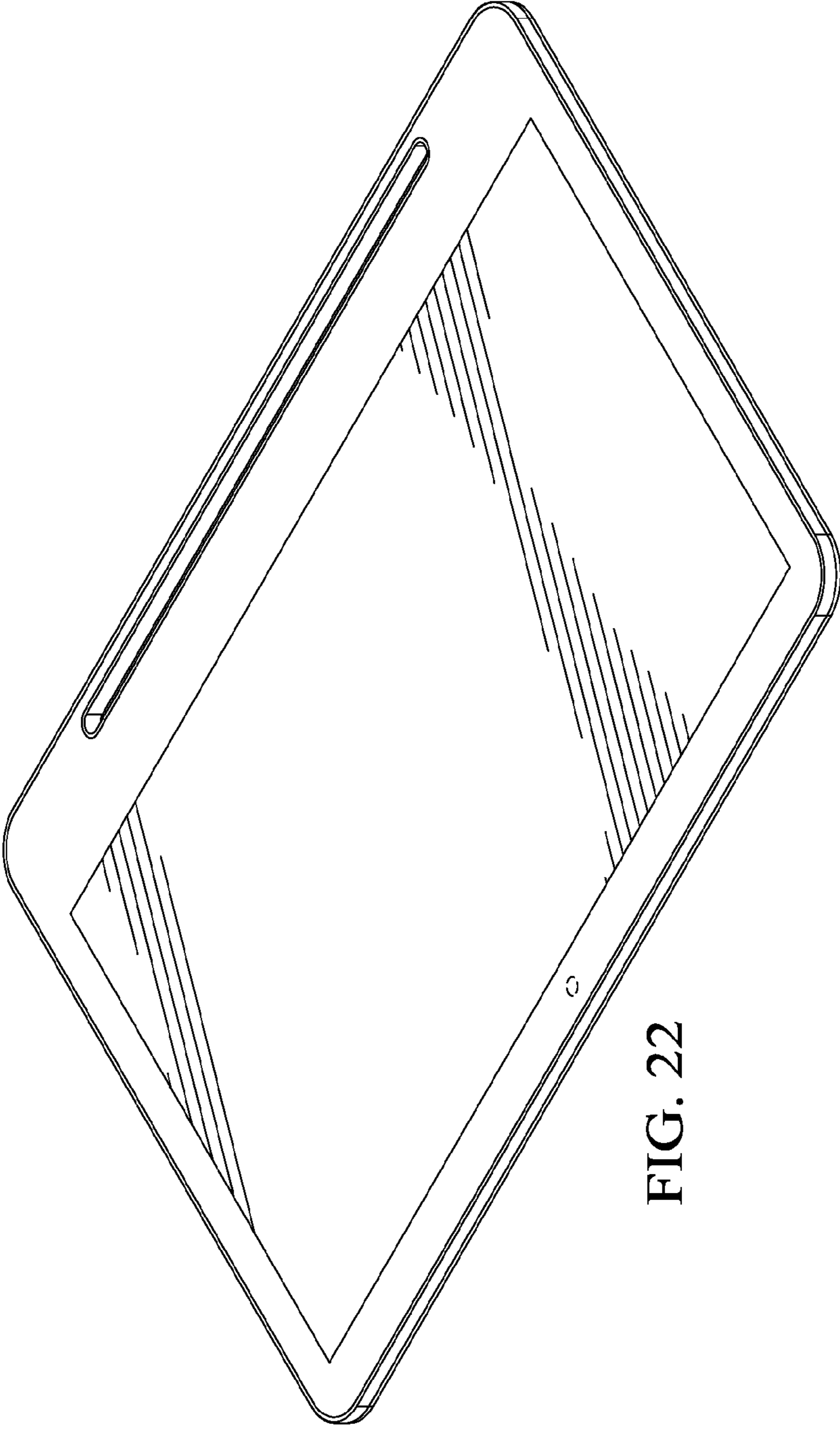

FIG. 22



FIG. 23



FIG. 24

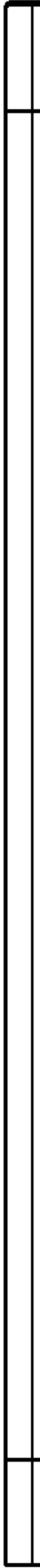

FIG. 25



FIG. 26

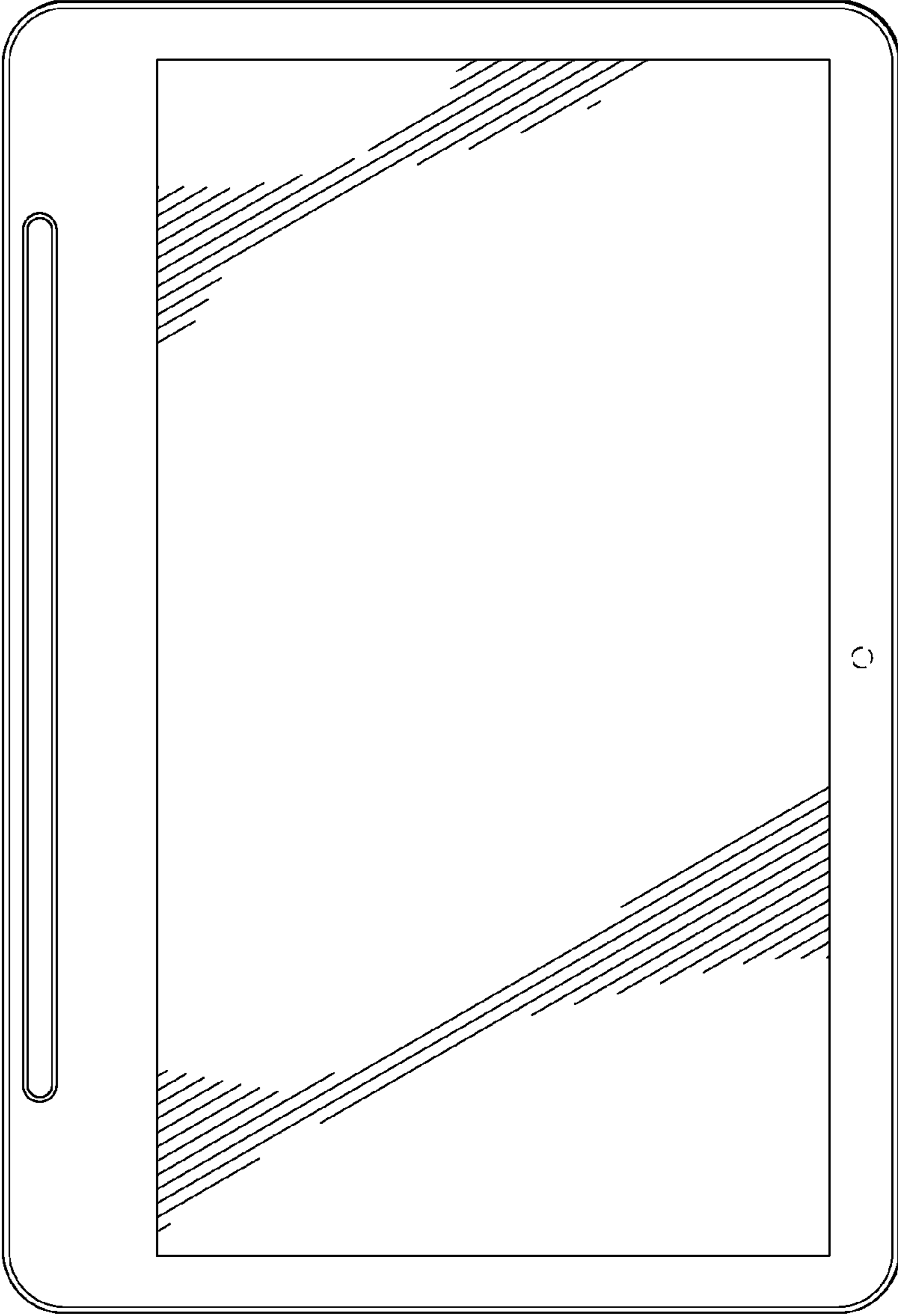

FIG. 27

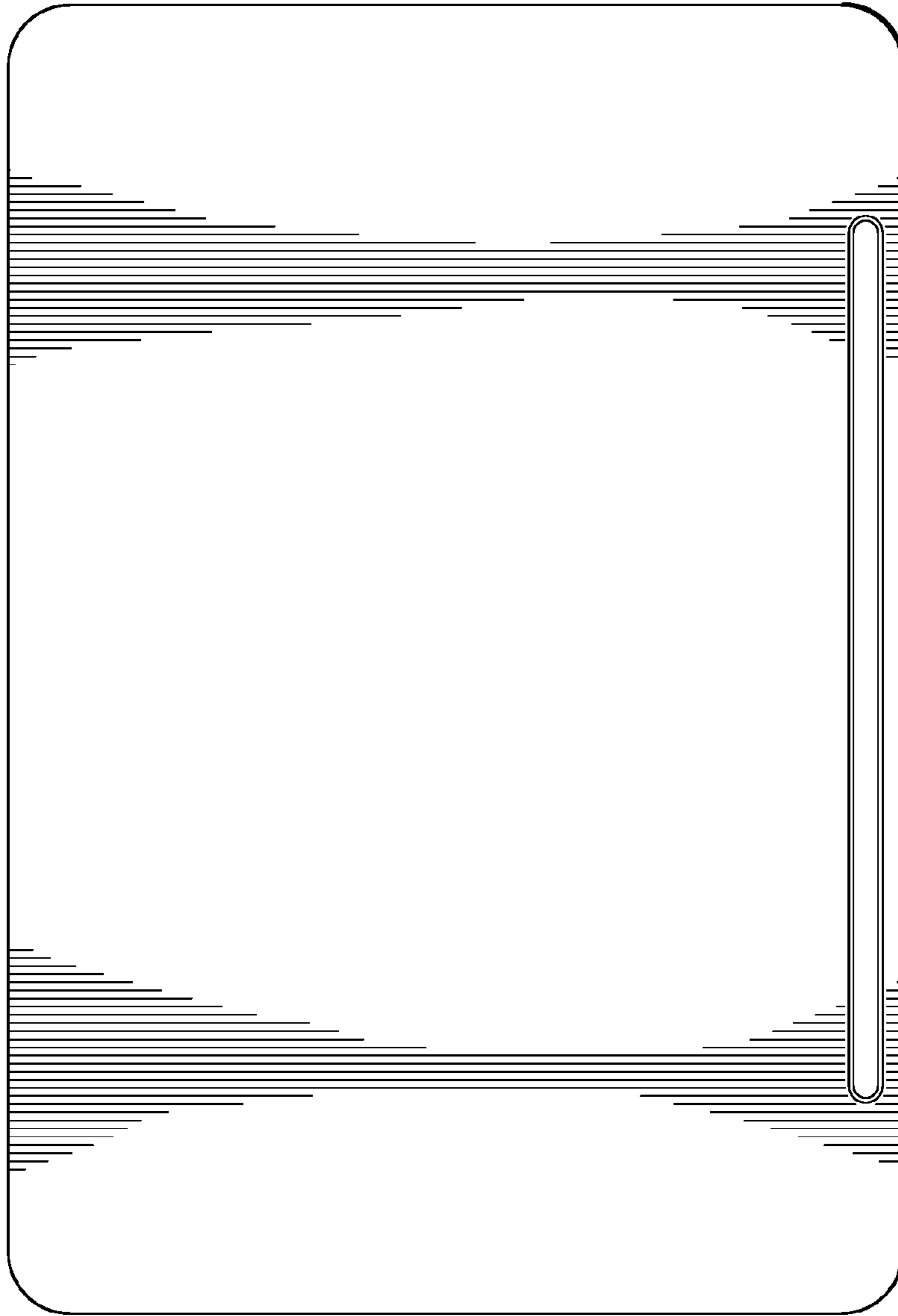

FIG. 28

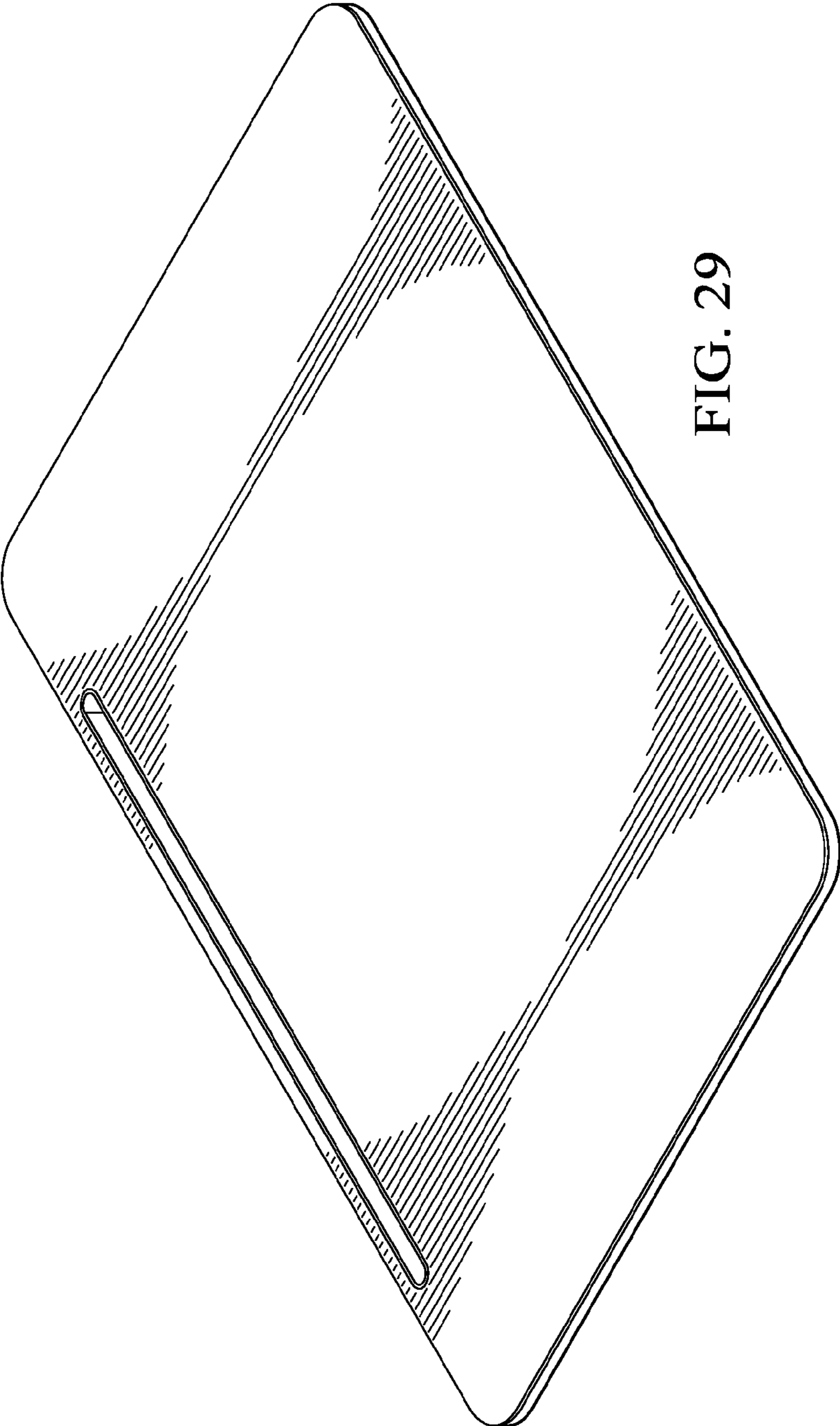

FIG. 29

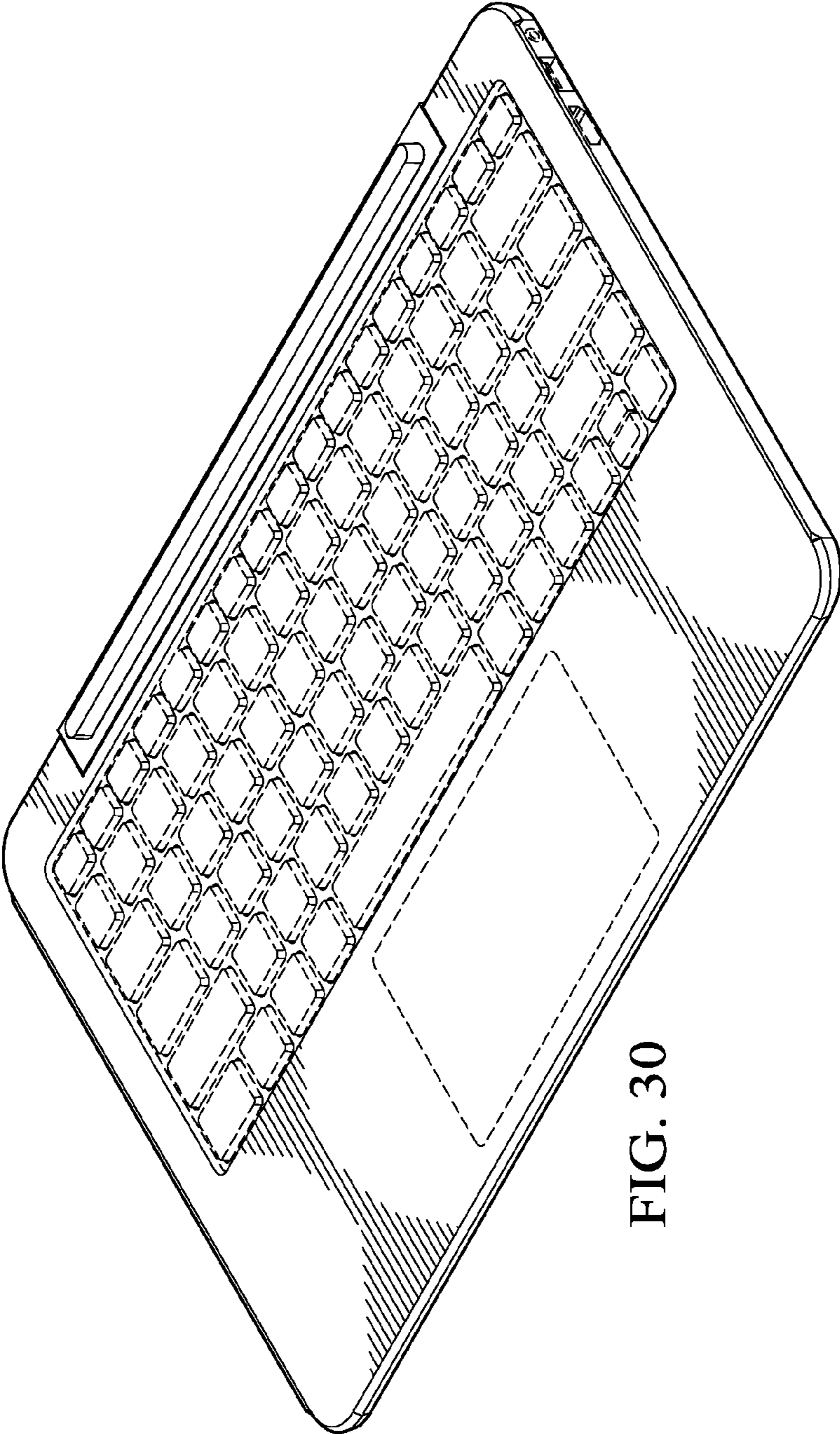

FIG. 30

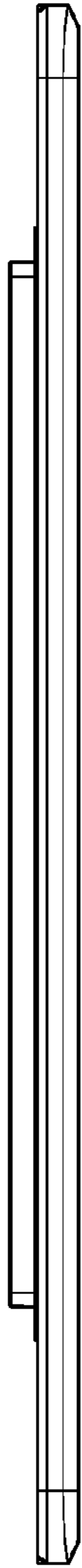

FIG. 31

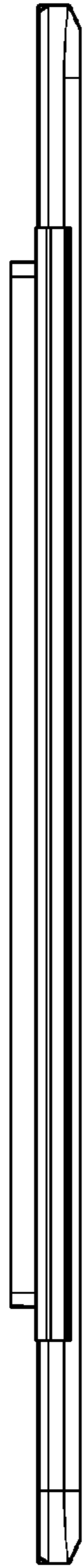

FIG. 32

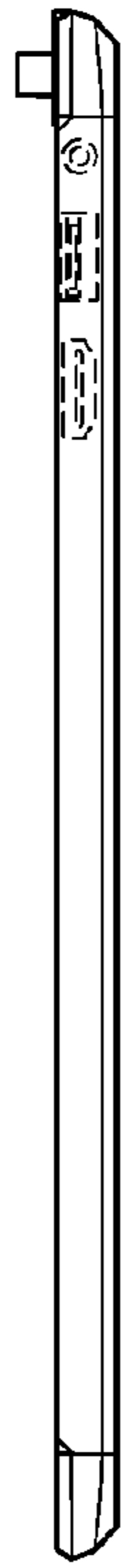

FIG. 33



FIG. 34

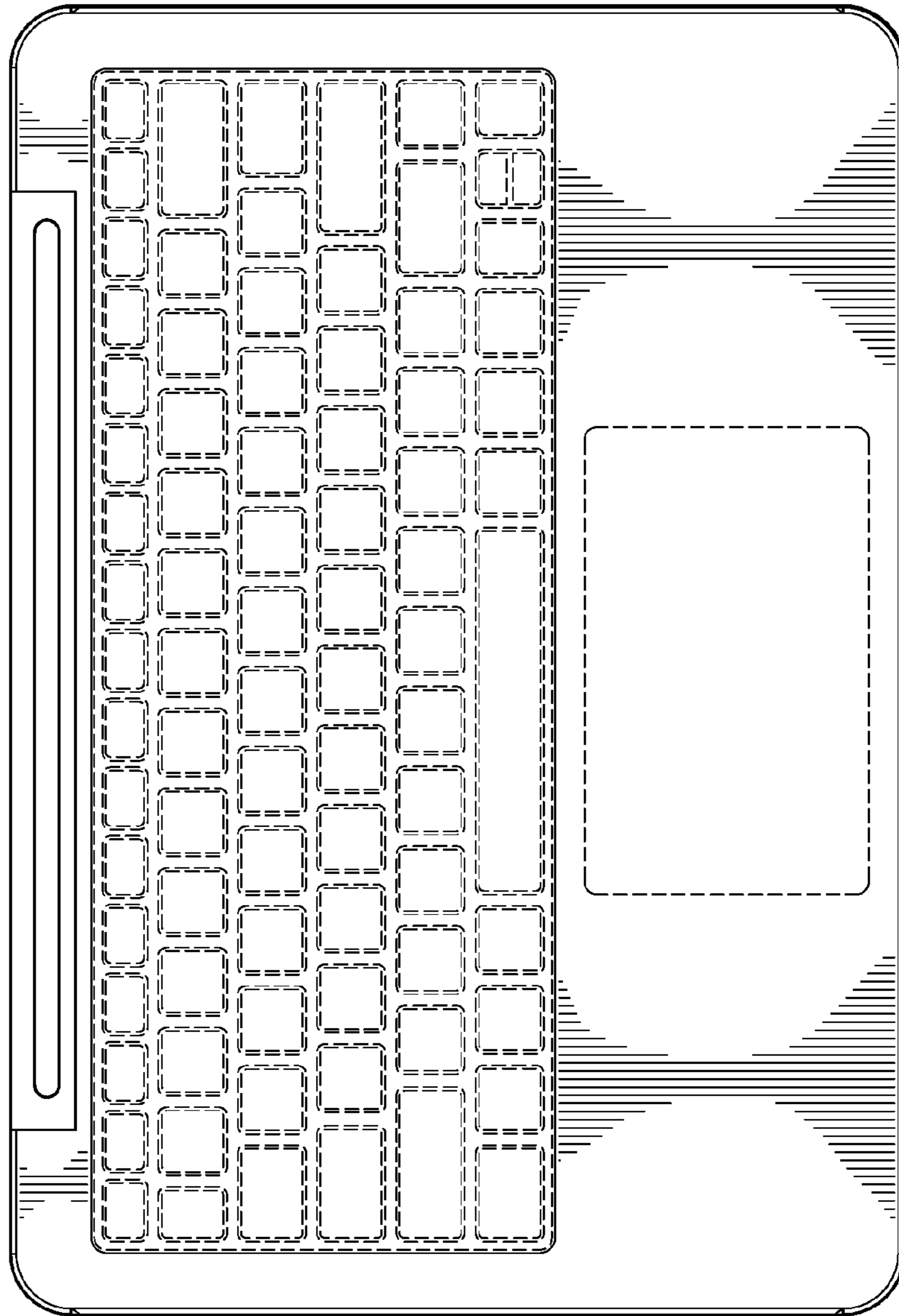

FIG. 35

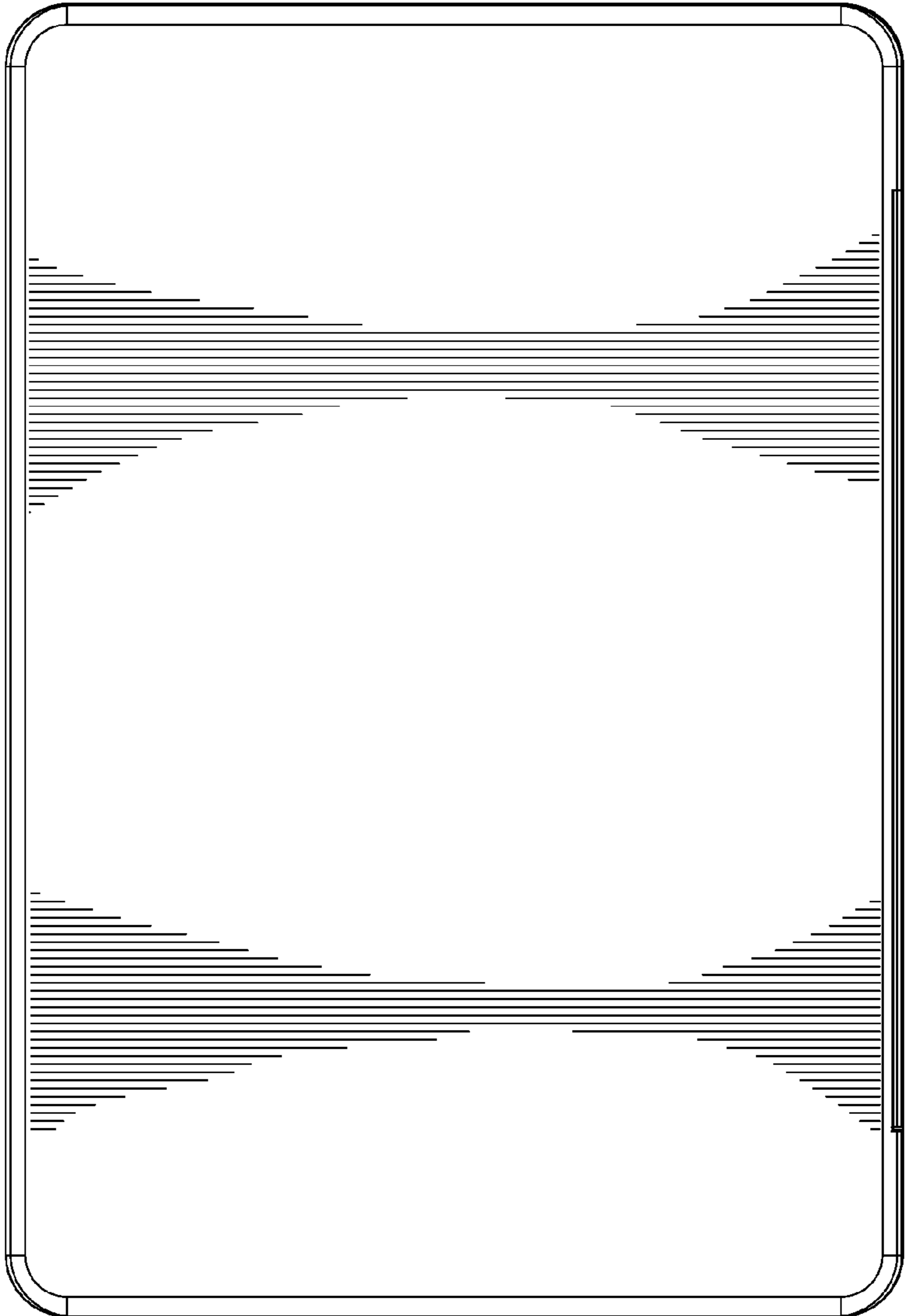

FIG. 36