

US00D766227S

(12) **United States Design Patent**  
**Wu**

(10) **Patent No.:** **US D766,227 S**  
(45) **Date of Patent:** **\*\* Sep. 13, 2016**

(54) **PROTECTIVE CASE FOR MOBILE PHONE**

(71) Applicant: **Electronic Silk Road (Shenzhen) Tech Co., Ltd.**, Shenzhen, Guangdong (CN)

(72) Inventor: **Chuan-cheng Wu**, Guangdong (CN)

(73) Assignee: **ELECTRONIC SILK ROAD (SHENZHEN) TECH CO., LTD.**, Shenzhen (CN)

(\*\*) Term: **15 Years**

(21) Appl. No.: **29/539,443**

(22) Filed: **Sep. 14, 2015**

(30) **Foreign Application Priority Data**

Mar. 17, 2015 (CN) ..... 2015 3 0063796

(51) **LOC (10) Cl.** ..... **14-03**

(52) **U.S. Cl.**  
USPC ..... **D14/250**

(58) **Field of Classification Search**

USPC ..... D14/238.1, 440, 203.3-203.7, 217, 240, D14/248, 251-253, 447, 496, 250; D3/201, D3/218, 247, 269, 273, 301, 303; D13/103, 107-108, 119  
CPC ..... H04B 1/3888; H04M 1/0283; H04M 1/0202; A45C 1/06; A45C 11/00; A45C 13/02; A45C 2011/002; A45F 2005/026; A45F 2200/0525; A45F 2200/0516  
See application file for complete search history.

(56) **References Cited**

**U.S. PATENT DOCUMENTS**

7,938,260 B2 \* 5/2011 Lin ..... A45C 11/00 206/320  
D682,260 S \* 5/2013 Tages ..... D14/250  
D684,150 S \* 6/2013 Goradesky ..... D14/250  
D718,290 S \* 11/2014 Whitten ..... D14/250  
D721,070 S \* 1/2015 Pickett ..... D14/250  
D721,358 S \* 1/2015 Pickett ..... D14/250  
D725,379 S \* 3/2015 Dixon ..... D3/218

D726,170 S \* 4/2015 Ng ..... D14/250  
D730,889 S \* 6/2015 Leibenhaut ..... D14/253  
9,049,283 B1 \* 6/2015 Kim ..... H04M 1/21  
9,060,580 B2 \* 6/2015 Tages ..... A45C 11/00  
9,072,353 B2 \* 7/2015 Fathollahi ..... A45C 13/002  
9,176,532 B2 \* 11/2015 Tages ..... H04B 1/3888  
9,179,558 B1 \* 11/2015 Limber ..... H05K 5/0004  
D745,524 S \* 12/2015 Hung ..... D14/440  
D746,274 S \* 12/2015 Herbst ..... D14/250  
D748,613 S \* 2/2016 Sasaki ..... D14/250  
D755,772 S \* 5/2016 Sasaki ..... D14/250  
2013/0111711 A1 \* 5/2013 Haase ..... A45F 5/00 24/307  
2013/0331155 A1 \* 12/2013 Tages ..... H04M 1/185 455/575.8  
2014/0048574 A1 \* 2/2014 Kimble ..... A45F 5/00 224/257  
2014/0066141 A1 \* 3/2014 Xu ..... H04M 1/23 455/575.4  
2015/0068934 A1 \* 3/2015 Armstrong ..... A45C 11/00 206/320  
2015/0156900 A1 \* 6/2015 Yeh ..... H04B 1/3888 312/223.1  
2016/0135560 A1 \* 5/2016 Yeh ..... A45C 11/00 224/581  
2016/0173158 A1 \* 6/2016 Day ..... H04B 1/3888 455/575.8

\* cited by examiner

*Primary Examiner* — Carla Jobe Wright

(57) **CLAIM**

The ornamental design for a protective case for mobile phone, as shown and described.

**DESCRIPTION**

FIG. 1 is a front elevational view of a protective case for mobile phone showing my new design; FIG. 2 is a rear elevational view thereof; FIG. 3 is a left side view thereof; FIG. 4 is a right side view thereof; FIG. 5 is a top plan view thereof; FIG. 6 is a bottom plan view thereof; FIG. 7 is a first perspective view thereof; FIG. 8 is a second perspective view thereof; and, FIG. 9 is a third perspective view thereof.

**1 Claim, 8 Drawing Sheets**

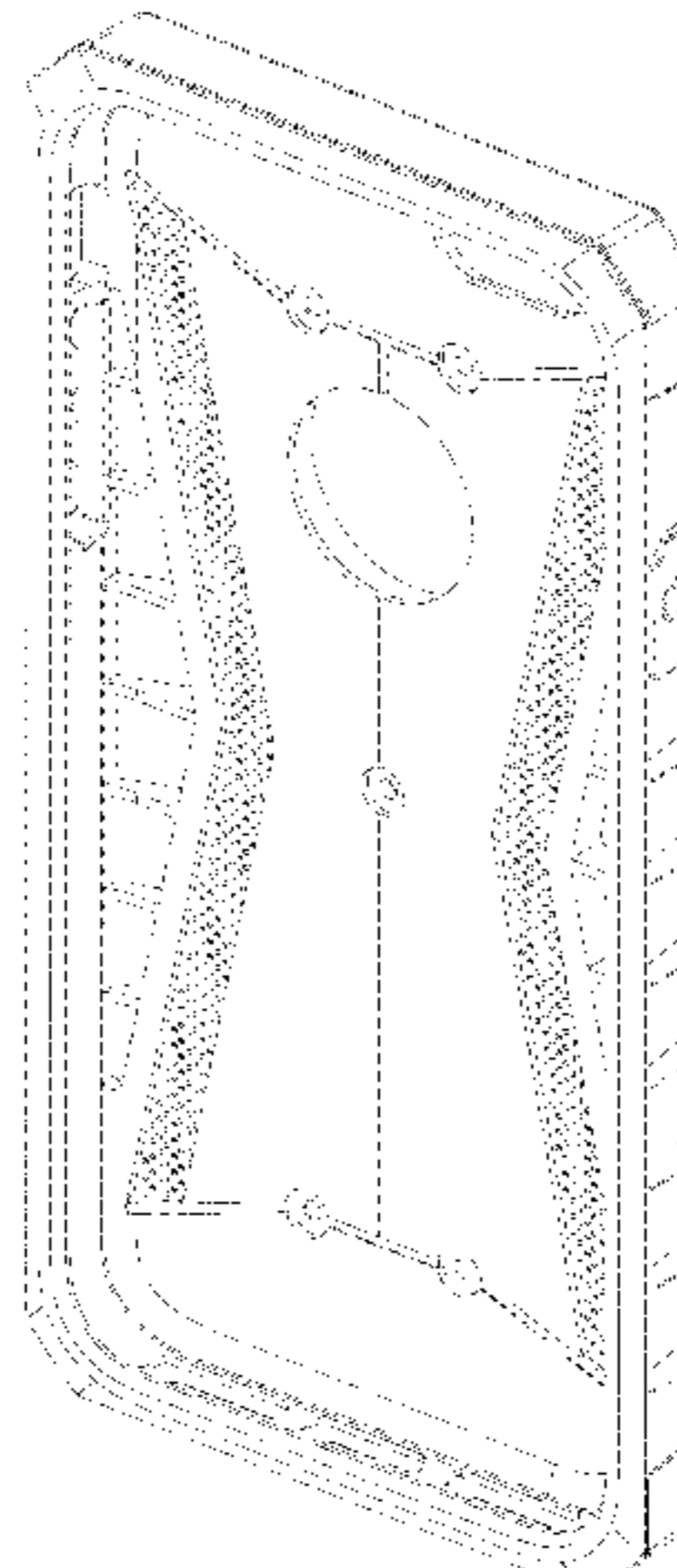
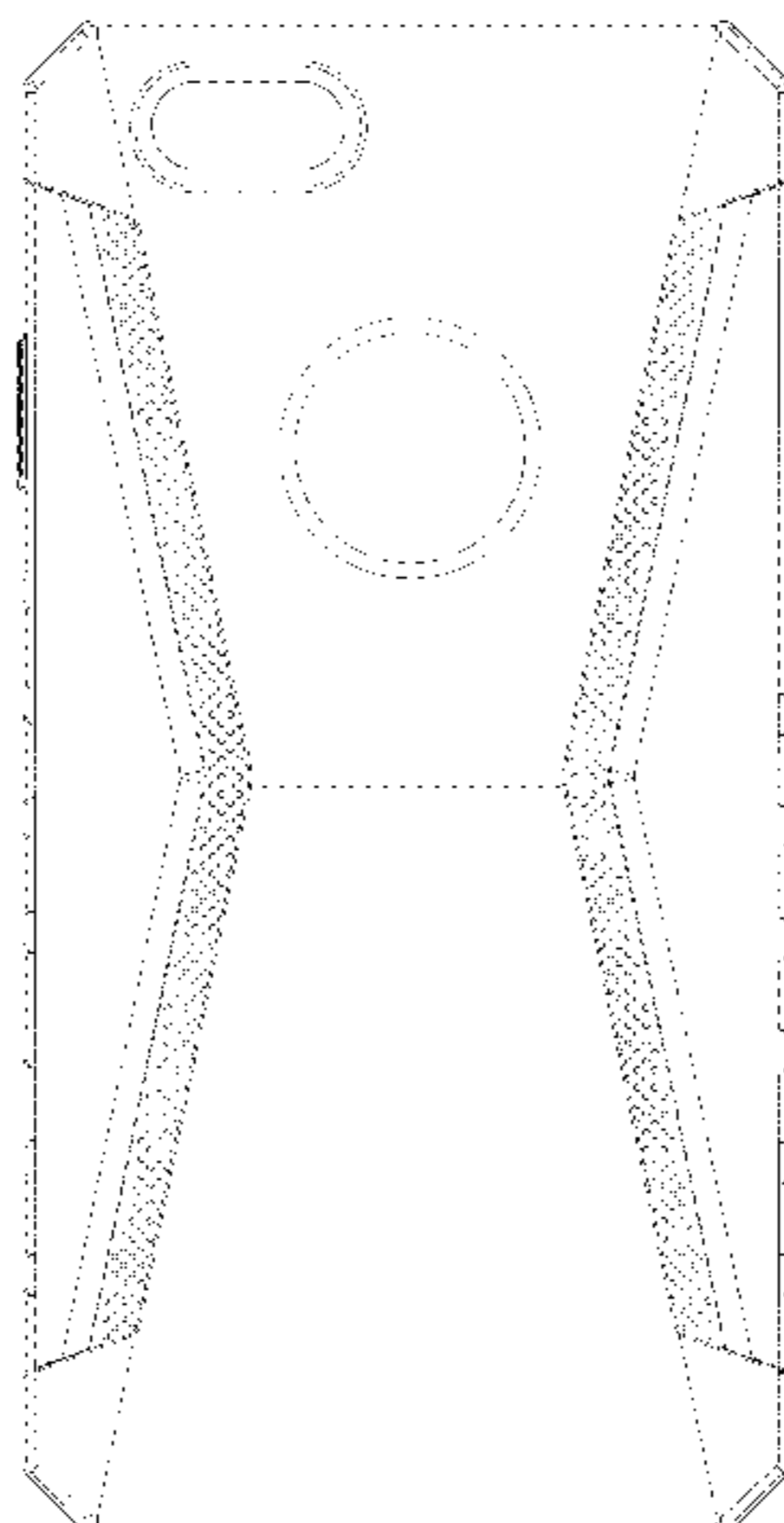

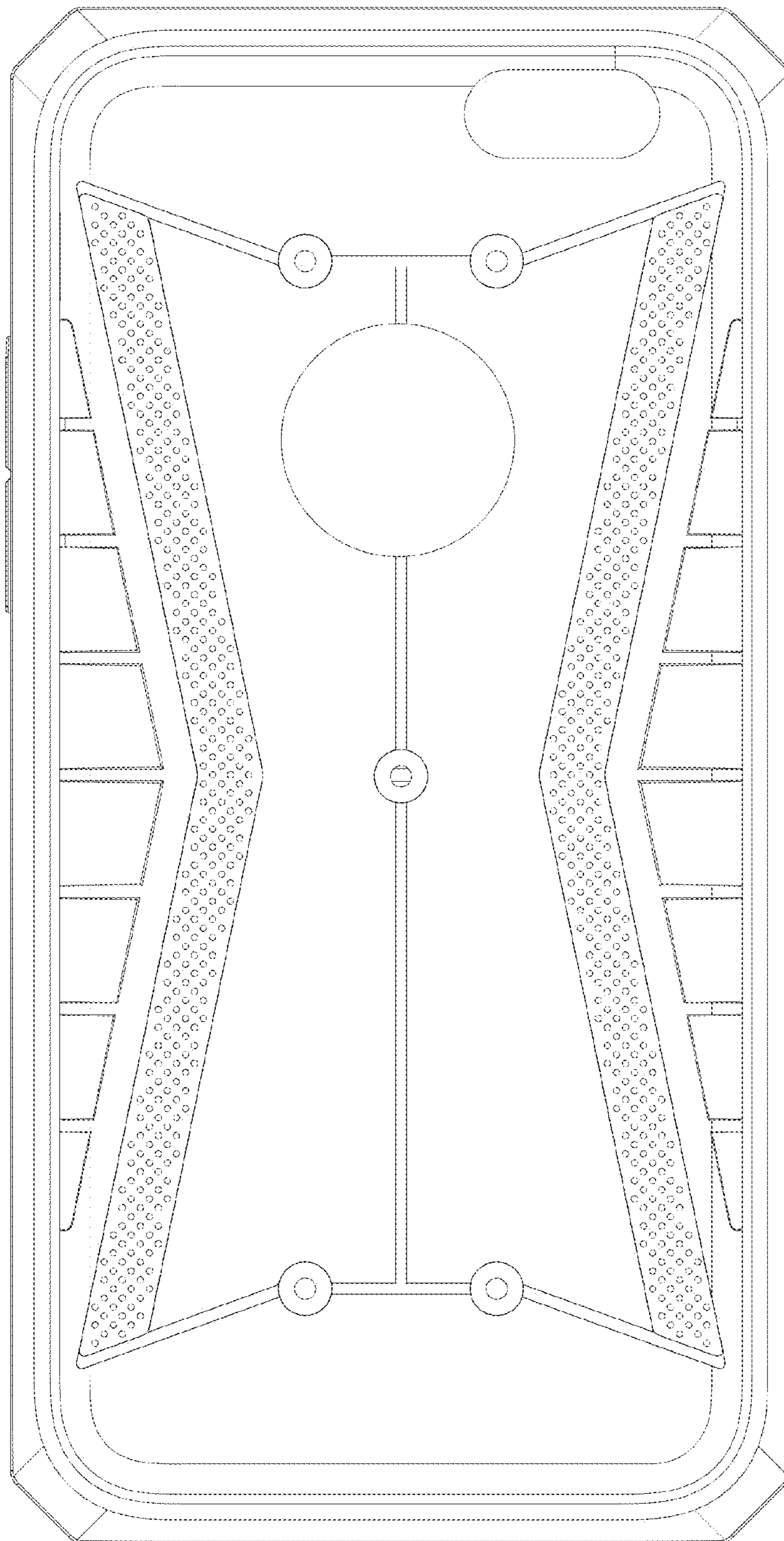

Fig. 1

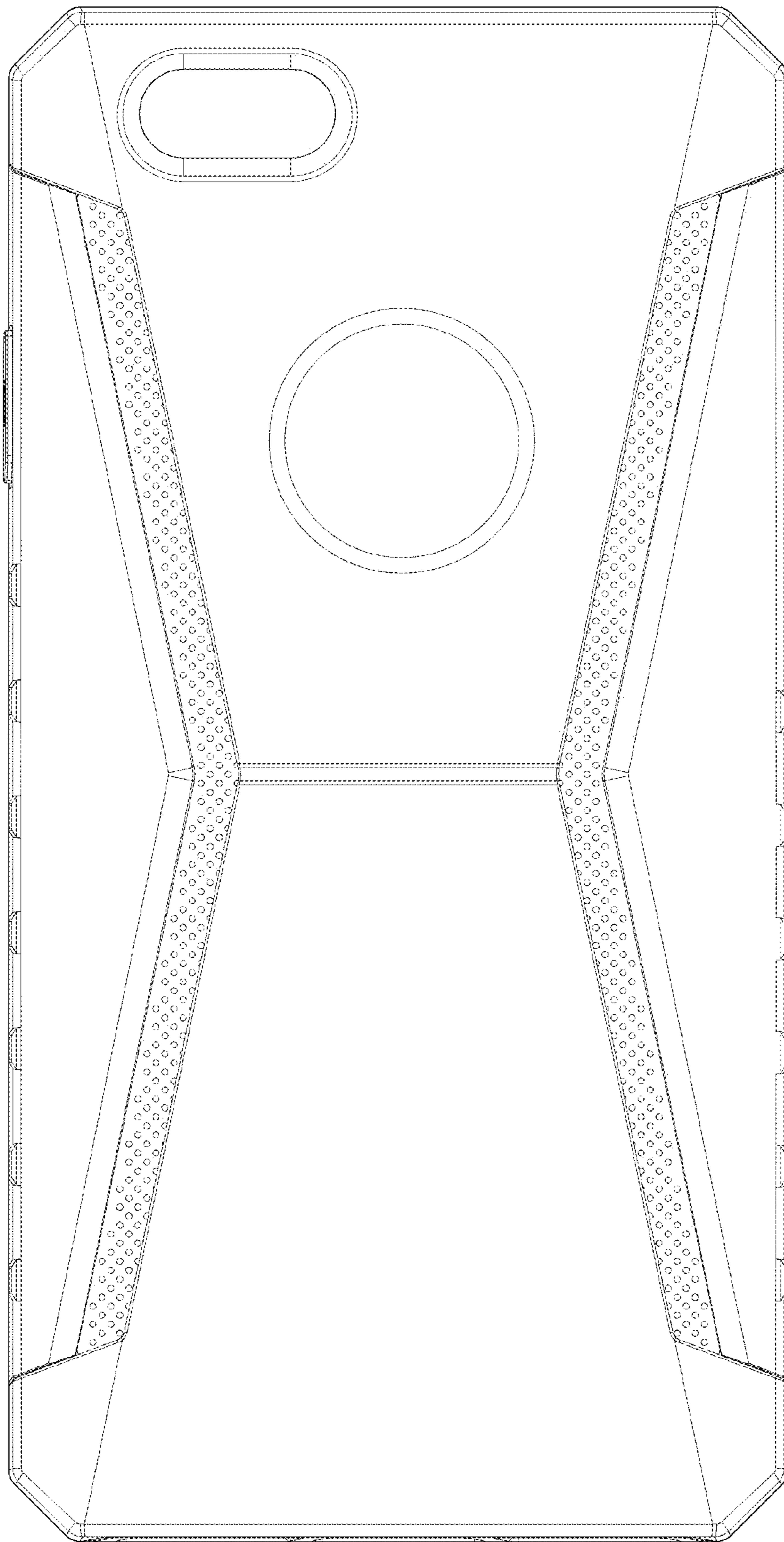

Fig. 2

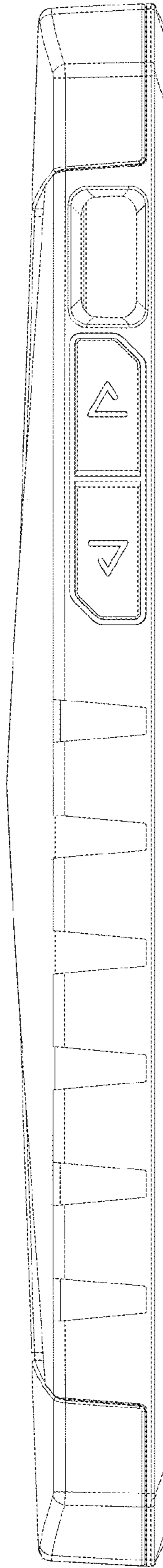

Fig. 3

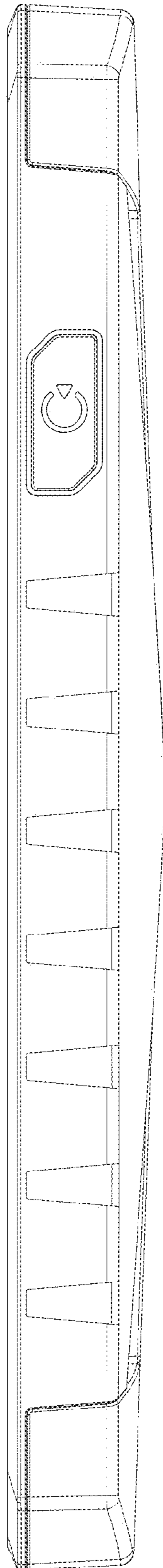

Fig. 4

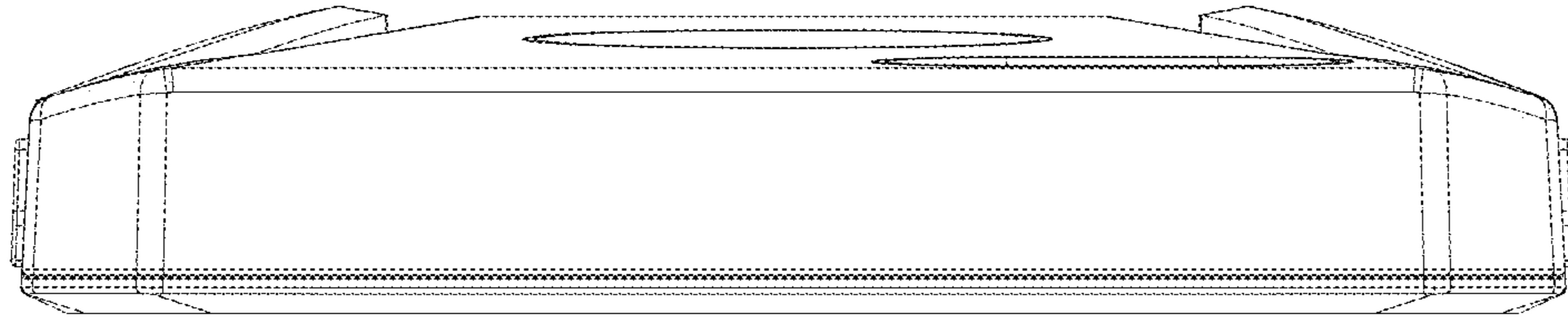

Fig. 5

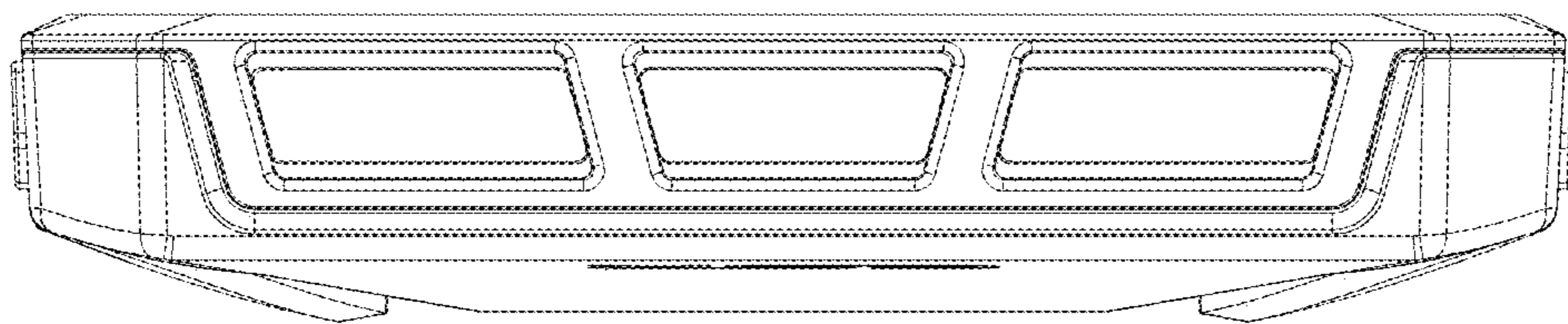

Fig. 6

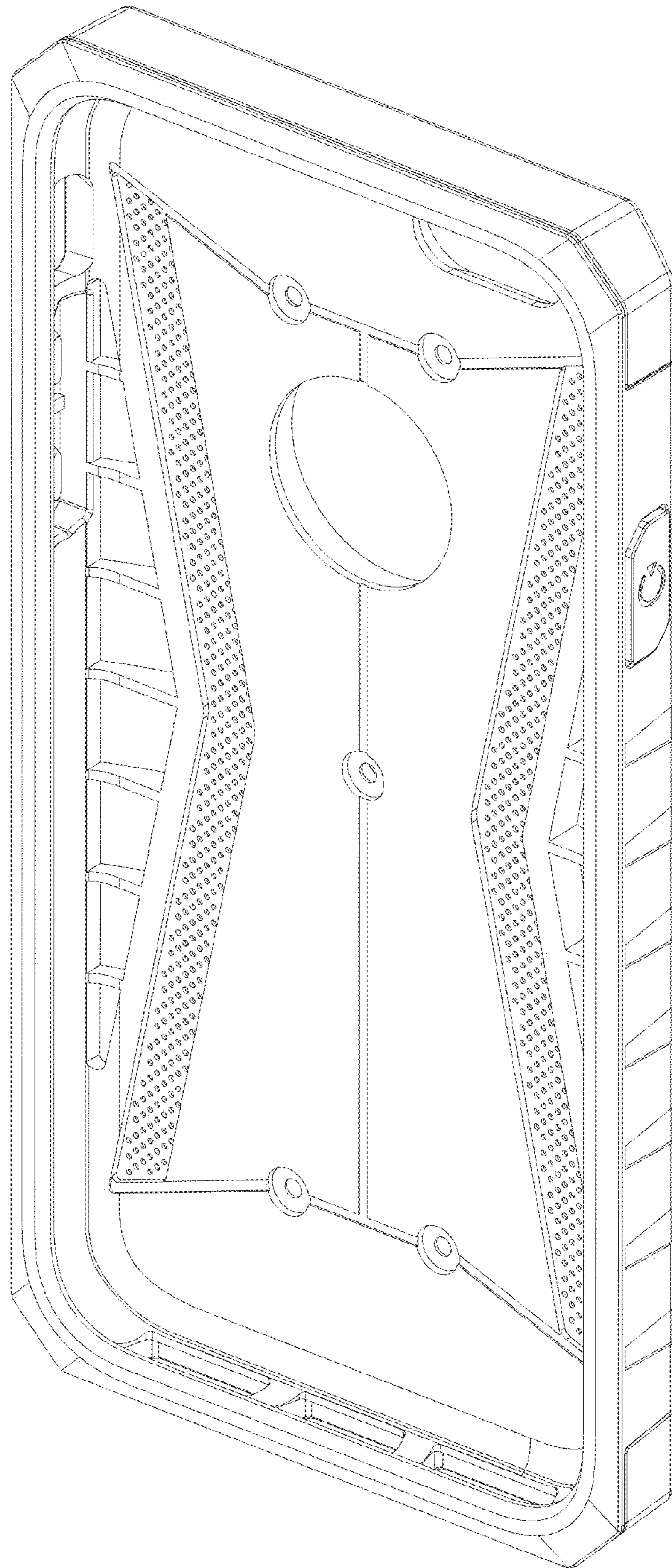

Fig. 7

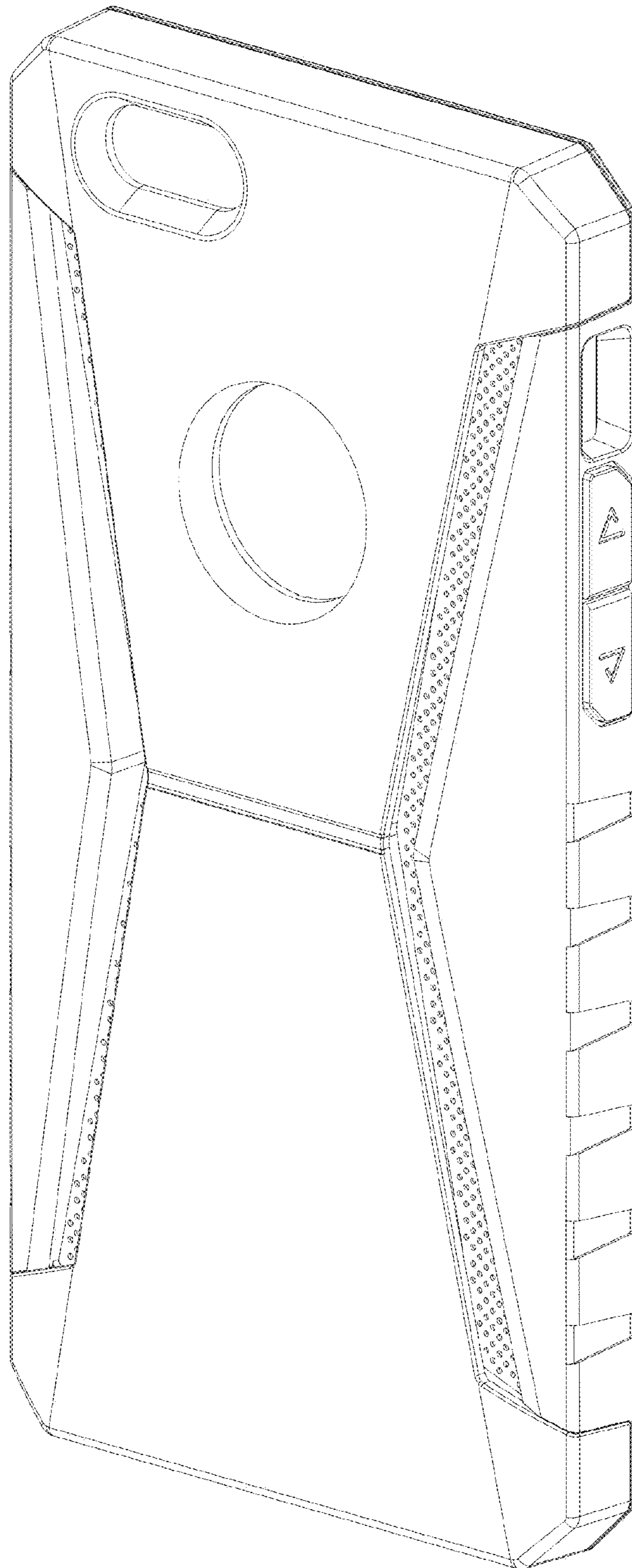

Fig. 8



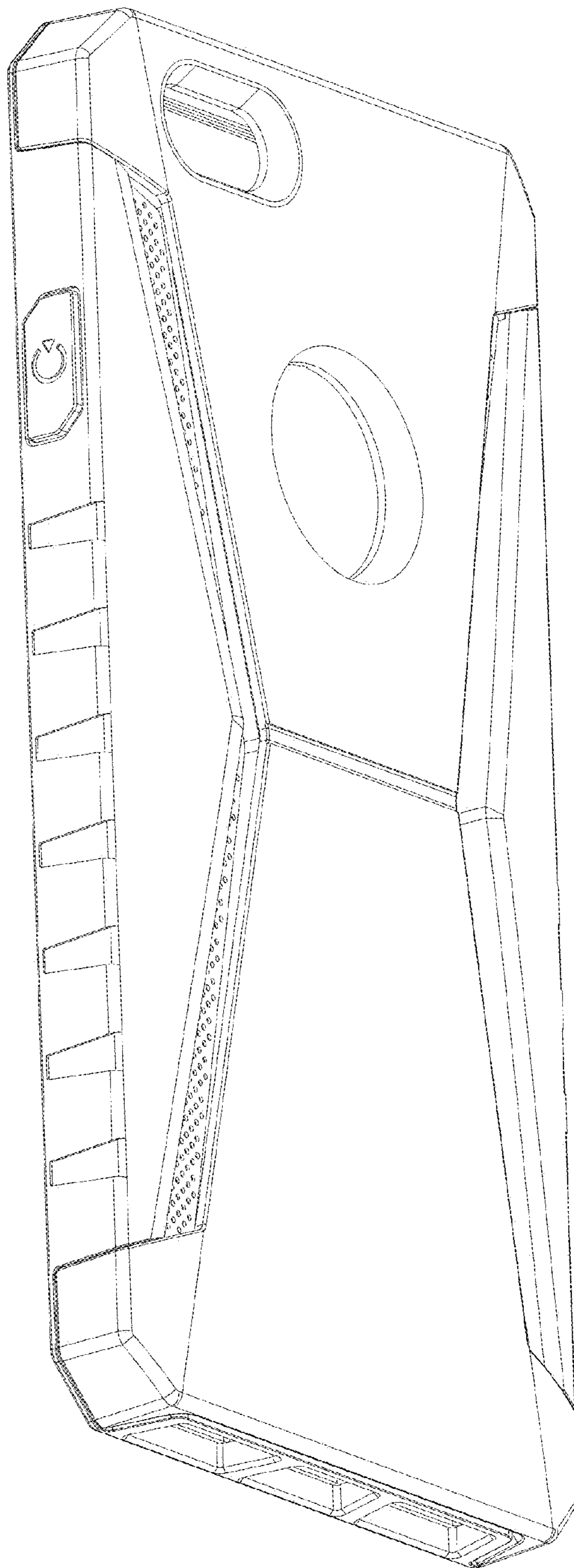

Fig. 9