



US00D766217S

(12) **United States Design Patent**
Smith et al.

(10) **Patent No.:** **US D766,217 S**
(45) **Date of Patent:** **** Sep. 13, 2016**

(54) **CONTROL**

(71) Applicant: **DOMETIC SWEDEN AB**, Solna (SE)

(72) Inventors: **Mark Smith**, Buchanan, MI (US);
Darren Grumm, Cassopolis, MI (US);
Merle Miller, III, Granger, IN (US)

(73) Assignee: **Dometic Sweden AB**, Solna (SE)

(**) Term: **14 Years**

(21) Appl. No.: **29/515,680**

(22) Filed: **Jan. 26, 2015**

Related U.S. Application Data

(62) Division of application No. 29/466,312, filed on Sep. 6, 2013, now Pat. No. Des. 738,355.

(51) **LOC (10) Cl.** **14-03**

(52) **U.S. Cl.**
USPC **D14/218**

(58) **Field of Classification Search**
USPC D14/218, 412, 400, 420, 169;
D7/396.5, 396.1, 402, 409, 387;
D6/306, 309, 407, 300; D21/324, 710,
D21/402; 341/176, 173; D13/171, 168, 162,
D13/108; D10/49; 340/12.15; D16/237;
D19/237, 86
CPC A21B 3/13; G06F 3/0231; H04B 1/202;
G08C 17/02
See application file for complete search history.

(56) **References Cited**

U.S. PATENT DOCUMENTS

D39,588 S * 9/1908 Straker, Jr. D7/396.5
1,621,315 A * 3/1927 Evlyn A21B 3/13
126/385.1
D259,008 S * 4/1981 Cochrane D6/306

D266,471 S * 10/1982 Symington D6/309
D314,592 S * 2/1991 Feurey D21/324
D383,620 S * 9/1997 Smith D6/407

(Continued)

FOREIGN PATENT DOCUMENTS

CN 302044081 * 8/2012
CN 302304821 * 1/2013
CN 302641562 * 11/2013

OTHER PUBLICATIONS

Product Review—Pure Sensia 200D Connect Internet table radio -,
Announced Jan. 9, 2013, [Site Visited Jan. 4, 2016]http://
homenetworking01.info/2013/01/product-reviewpure-sensia-200d-
connect-internet-table-radio/.*

(Continued)

Primary Examiner — John Windmuller

Assistant Examiner — Luqman McNeil

(74) *Attorney, Agent, or Firm* — Middleton Reutlinger

(57) **CLAIM**

The ornamental design for a control, as shown and described.

DESCRIPTION

FIG. 1 is an isometric view of the control showing our new design;

FIG. 2 is a front view of the design of FIG. 1;

FIG. 3 is a rear view of the design of FIG. 1;

FIG. 4 is a side view of the design of FIG. 1;

FIG. 5 is another side view of the design of FIG. 1;

FIG. 6 is a top view of the design of FIG. 1; and,

FIG. 7 is a bottom view of the design of FIG. 1.

The broken lines are included for the purpose of illustrating portions of the control that form no part of the claimed design.

1 Claim, 7 Drawing Sheets

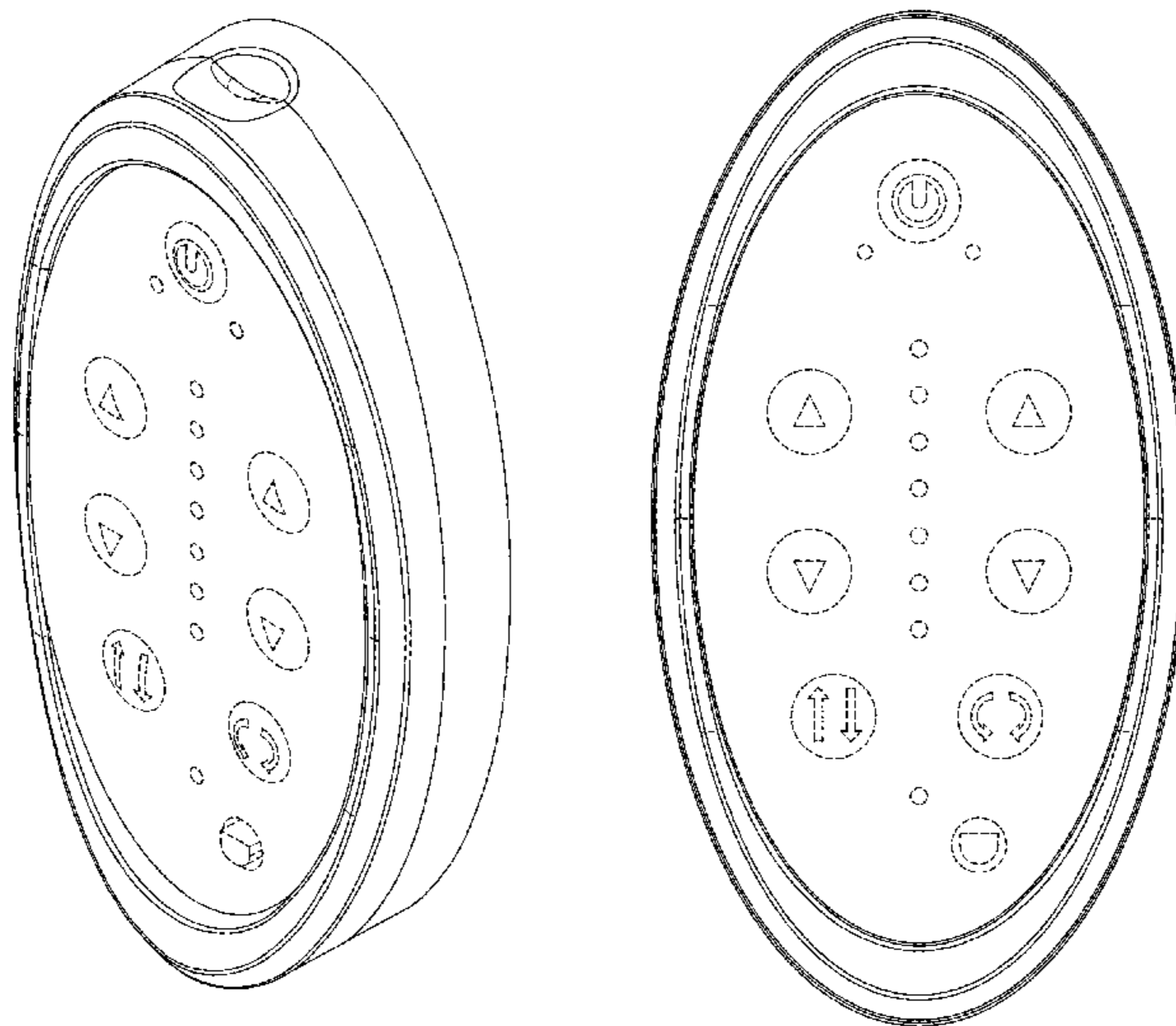

(56)

References Cited

U.S. PATENT DOCUMENTS

D394,159 S * 5/1998 Leung D6/300
 D421,873 S * 3/2000 Sundberg D7/396.1
 D431,114 S * 9/2000 Smith D21/710
 D432,356 S * 10/2000 Hoff D7/402
 D459,094 S * 6/2002 Stone D6/309
 D501,652 S * 2/2005 Pierson D13/171
 D526,973 S * 8/2006 Gates D13/168
 D530,525 S * 10/2006 Greene, II D6/309
 D540,395 S * 4/2007 Bailey D14/412
 D542,091 S * 5/2007 Hoff D7/409
 D561,113 S * 2/2008 Samhammer D13/162
 7,388,536 B2 * 6/2008 Kim H04B 1/202
 341/173
 D596,452 S * 7/2009 Komorski D7/387
 D601,564 S * 10/2009 Maeno D14/400
 D626,963 S * 11/2010 Kim D14/420
 D632,265 S * 2/2011 Choi D13/168
 D652,675 S * 1/2012 Miller D7/402
 D660,732 S * 5/2012 Bould D10/49
 8,188,842 B2 * 5/2012 Otsuka G08C 17/02
 340/12.15
 D673,512 S * 1/2013 Huang D13/168

D676,377 S * 2/2013 Nokuo D13/108
 D677,180 S * 3/2013 Plitkins D10/49
 D689,701 S * 9/2013 Mischel, Jr. D6/309
 D697,510 S * 1/2014 Sato D14/420
 D700,233 S * 2/2014 Kim D16/237
 D701,841 S * 4/2014 Huang D13/168
 D704,166 S * 5/2014 Sung D14/218
 D705,355 S * 5/2014 Webster D19/86
 D709,048 S * 7/2014 Ganske D14/169
 2003/0122698 A1 * 7/2003 Horie G06F 3/0231
 341/176

OTHER PUBLICATIONS

Photo: Philips 58PFL8900 TV private cinema to enjoy the country's first test, Announced Dec. 29, 2011, [Site Visited Jan. 4, 2016] <http://www.instant-news.us/news-490280.html>.
 Product Review—Pure Sensia 200D Connect Internet table radio -, Announced Jan. 9, 2013, [Site Visited Nov. 17, 2014] <http://homenetworking01.info/2013/01/product-reviewpure-sensia-200d-connect-internet-table-radio/>.
 Photo: Philips 58PFL8900 TV private cinema to enjoy the country's first test, Announced Dec. 29, 2011, [Site Visited Nov. 17, 2014] <http://www.instant-news.us/news-490280.html>.

* cited by examiner

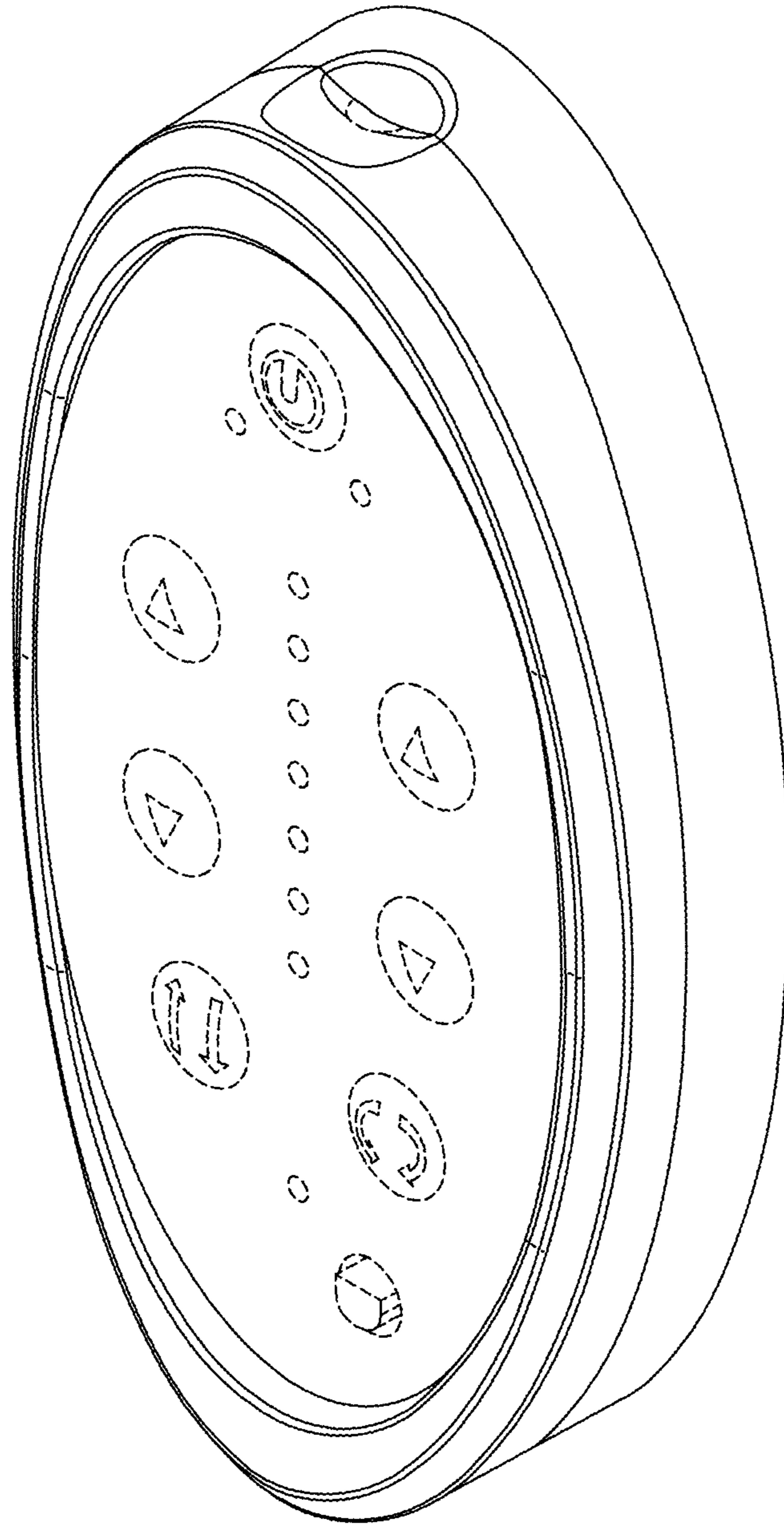

Fig. 1

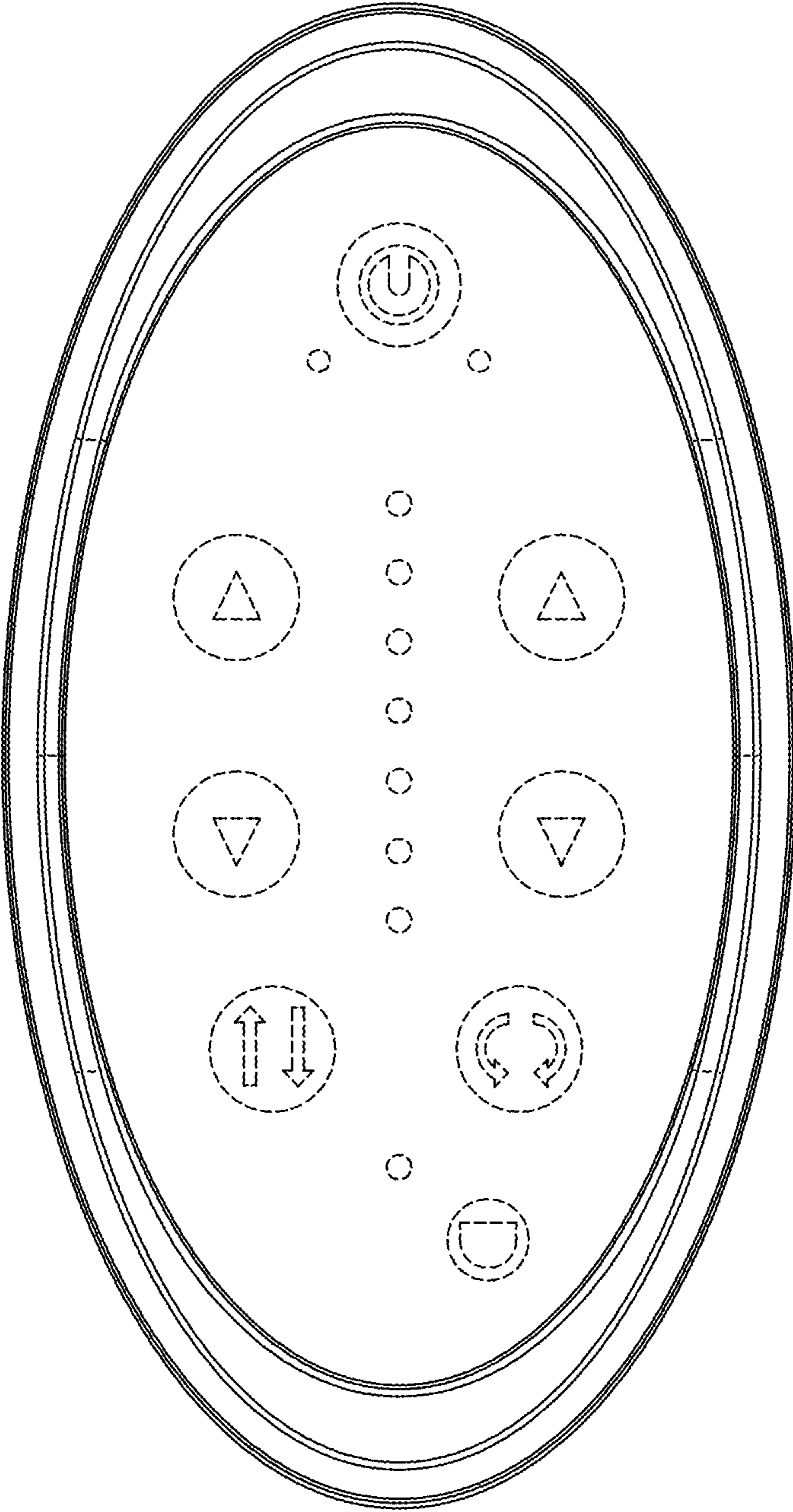

Fig. 2

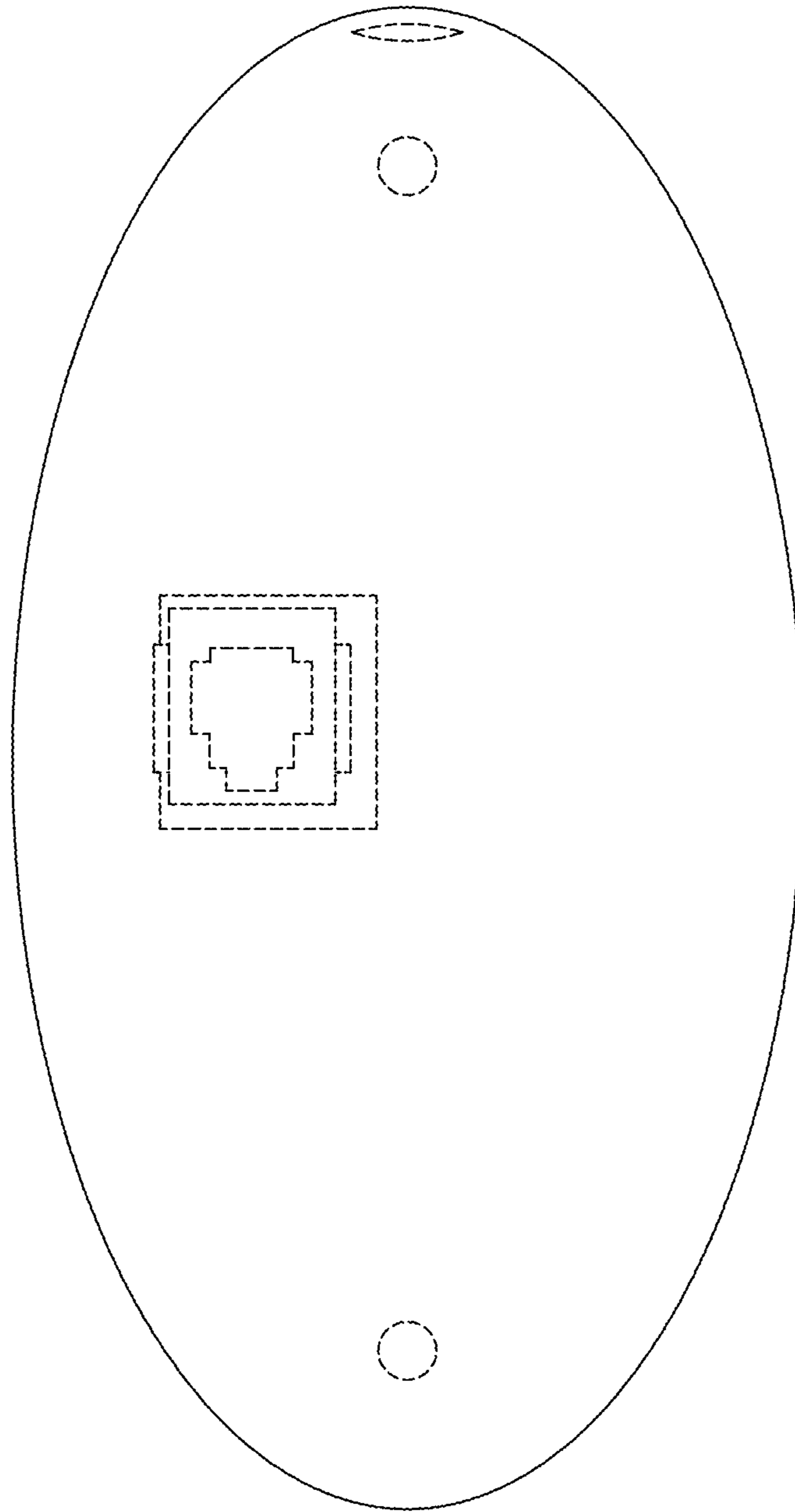

Fig. 3

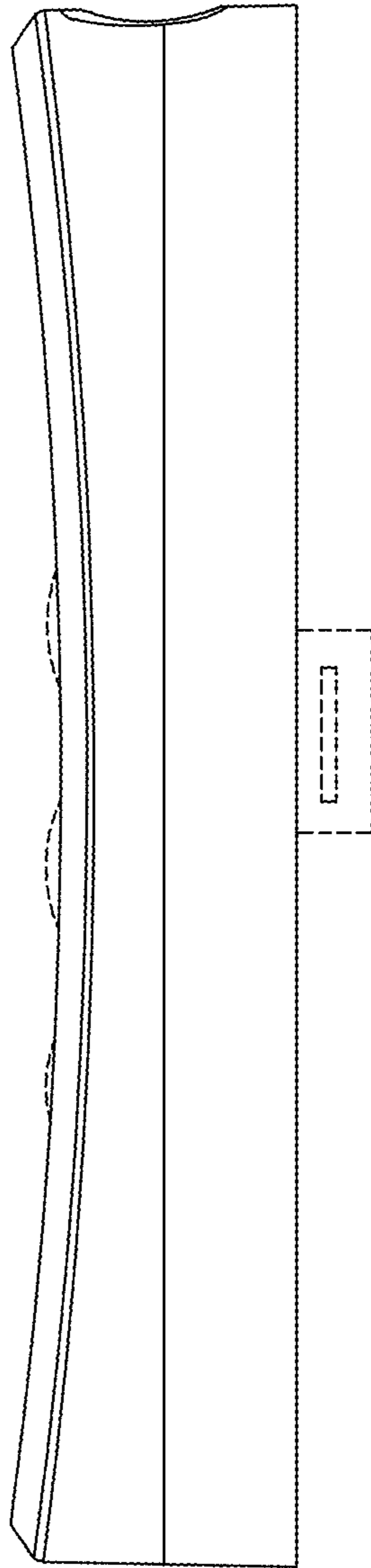

Fig. 4

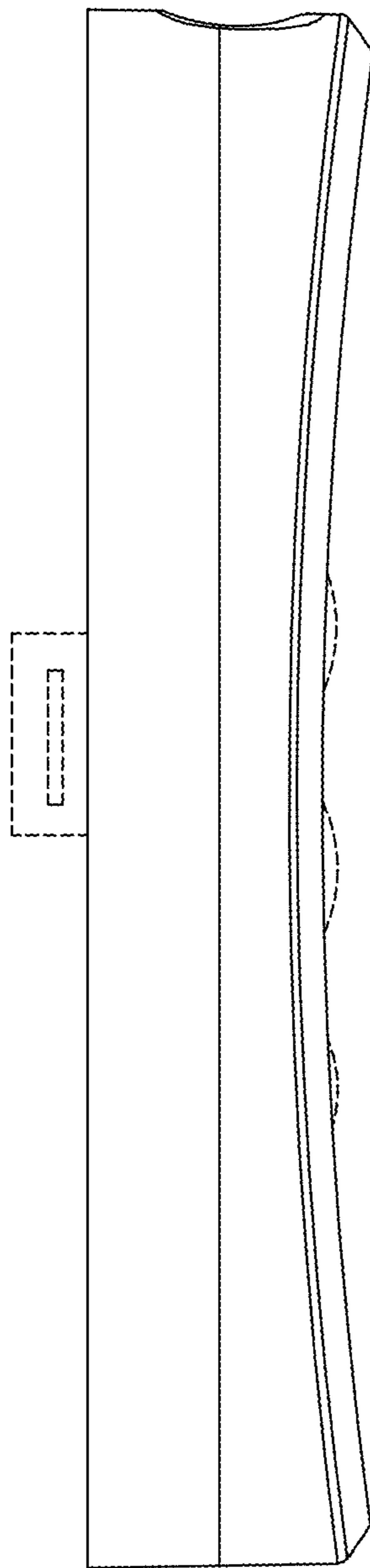

Fig. 5

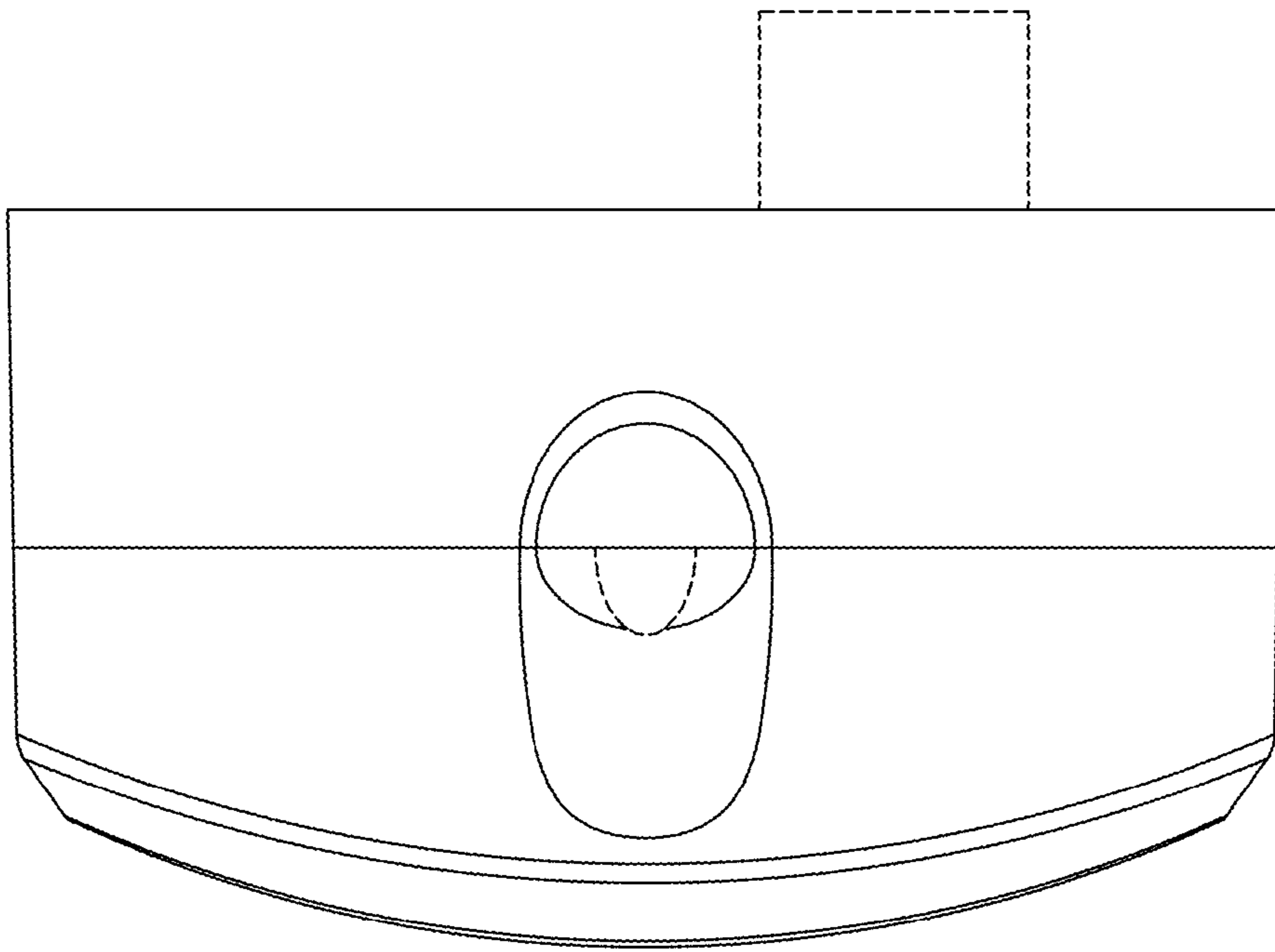

Fig. 6

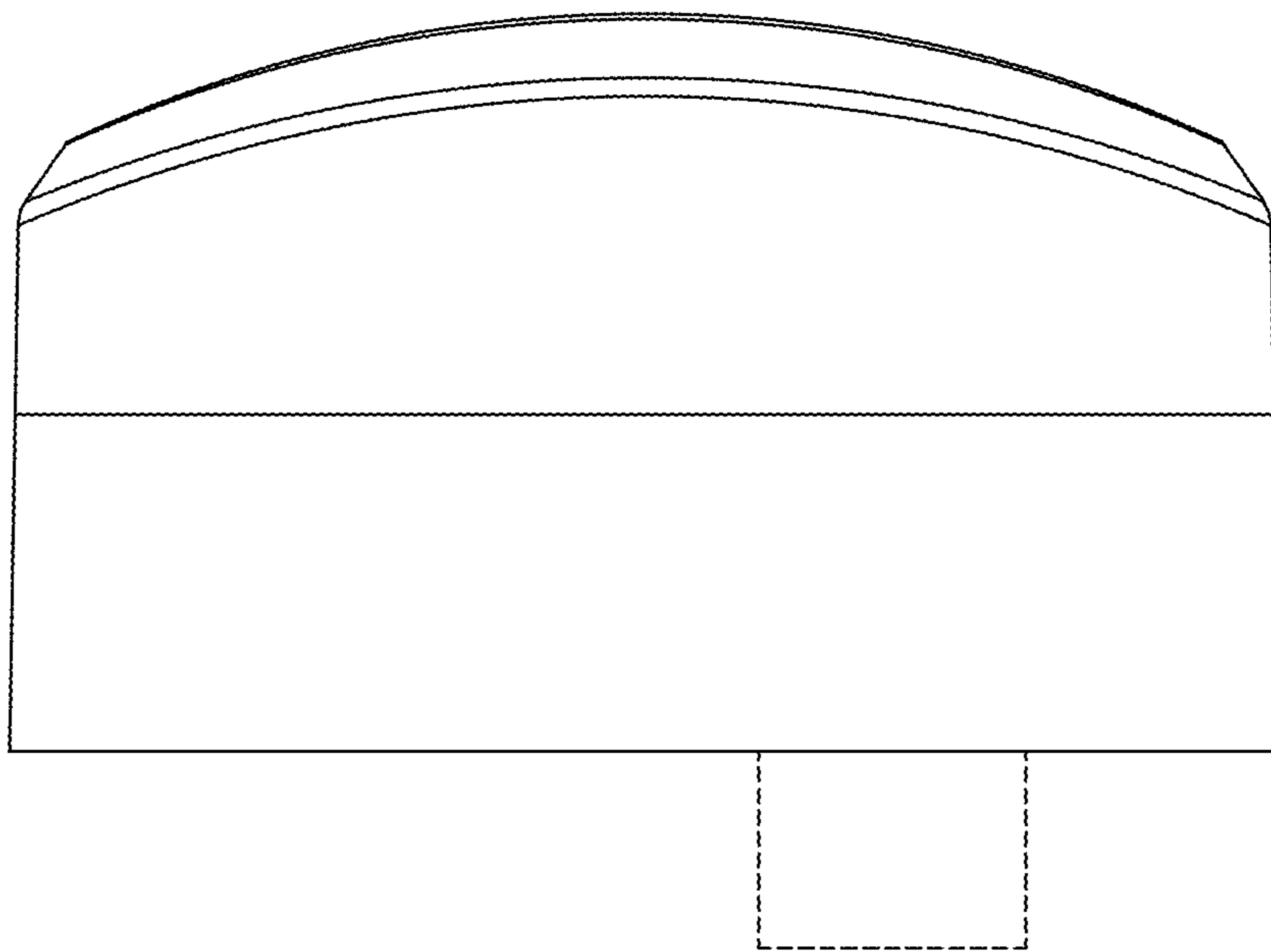

Fig. 7