



US00D766212S

(12) **United States Design Patent**
Choi

(10) **Patent No.:** **US D766,212 S**

(45) **Date of Patent:** **** Sep. 13, 2016**

(54) **SPEAKER**

H04R 2499/11; H04R 2499/13; H04R
2499/15; H04S 3/00; H04S 7/30

(71) Applicant: **Samsung Electronics Co., Ltd.**,
Suwon-si, Gyeonggi-do (KR)

See application file for complete search history.

(72) Inventor: **Gyoo-sang Choi**, Suwon-si (KR)

(56) **References Cited**

(73) Assignee: **SAMSUNG ELECTRONICS CO.,
LTD.**, Suwon-Si, Gyeonggi-Do (KR)

U.S. PATENT DOCUMENTS

(**) Term: **15 Years**

D506,746 S *	6/2005	Hioki	D14/214
D516,544 S *	3/2006	Motoishi	D14/214
D517,049 S *	3/2006	Katsumata	D14/214
D544,855 S *	6/2007	Hibino	D14/214
D723,518 S *	3/2015	Moon	D14/215
D744,981 S *	12/2015	Choi	D14/209.1
D747,698 S *	1/2016	Choi	D14/188

(21) Appl. No.: **29/531,392**

* cited by examiner

(22) Filed: **Jun. 25, 2015**

(30) **Foreign Application Priority Data**

Primary Examiner — Keli L Hill

Jan. 5, 2015 (KR) 30-2015-0000274

(74) *Attorney, Agent, or Firm* — Ladas & Parry LLP

(51) **LOC (10) Cl.** **14-03**

(57) **CLAIM**

(52) **U.S. Cl.**

I claim the ornamental design for a speaker, as shown and described.

USPC **D14/214**; D14/215; D14/222

(58) **Field of Classification Search**

DESCRIPTION

USPC D14/167, 168, 170–172, 188, 194–196,
D14/204, 207, 209.1, 210–216, 219, 221,
D14/222, 224, 239, 496; 181/143, 144, 147,
181/148, 150, 153, 157, 198, 199;
381/300–303, 306, 332, 333, 336, 345,
381/361–364, 386–388; 369/6–12

FIG. 1 is the front perspective view of a speaker showing my new design;

FIG. 2 is the front view thereof;

FIG. 3 is the rear view thereof;

FIG. 4 is the left-side view thereof;

FIG. 5 is the right-side view thereof;

FIG. 6 is the top plan view thereof; and,

FIG. 7 is the bottom plan view thereof.

CPC ... B60R 11/0217; G06F 1/1688; G10K 9/22;
G10K 11/004; H03F 1/327; H04M 1/03;
H04M 1/035; H04N 5/642; H04N 21/4852;
H04R 1/02; H04R 1/06; H04R 1/021; H04R
1/025; H04R 1/026; H04R 1/028; H04R
1/105; H04R 1/323; H04R 1/403; H04R
1/2803; H04R 1/2834; H04R 5/02; H04R
7/20; H04R 9/06; H04R 9/025; H04R
2201/021; H04R 2400/00; H04R 2400/07;

The broken lines in the drawing show unclaimed environment only and form no part of the claimed design.

The dot dash lines in the figures represent an unclaimed boundary line and form no part of the claimed design.

1 Claim, 7 Drawing Sheets

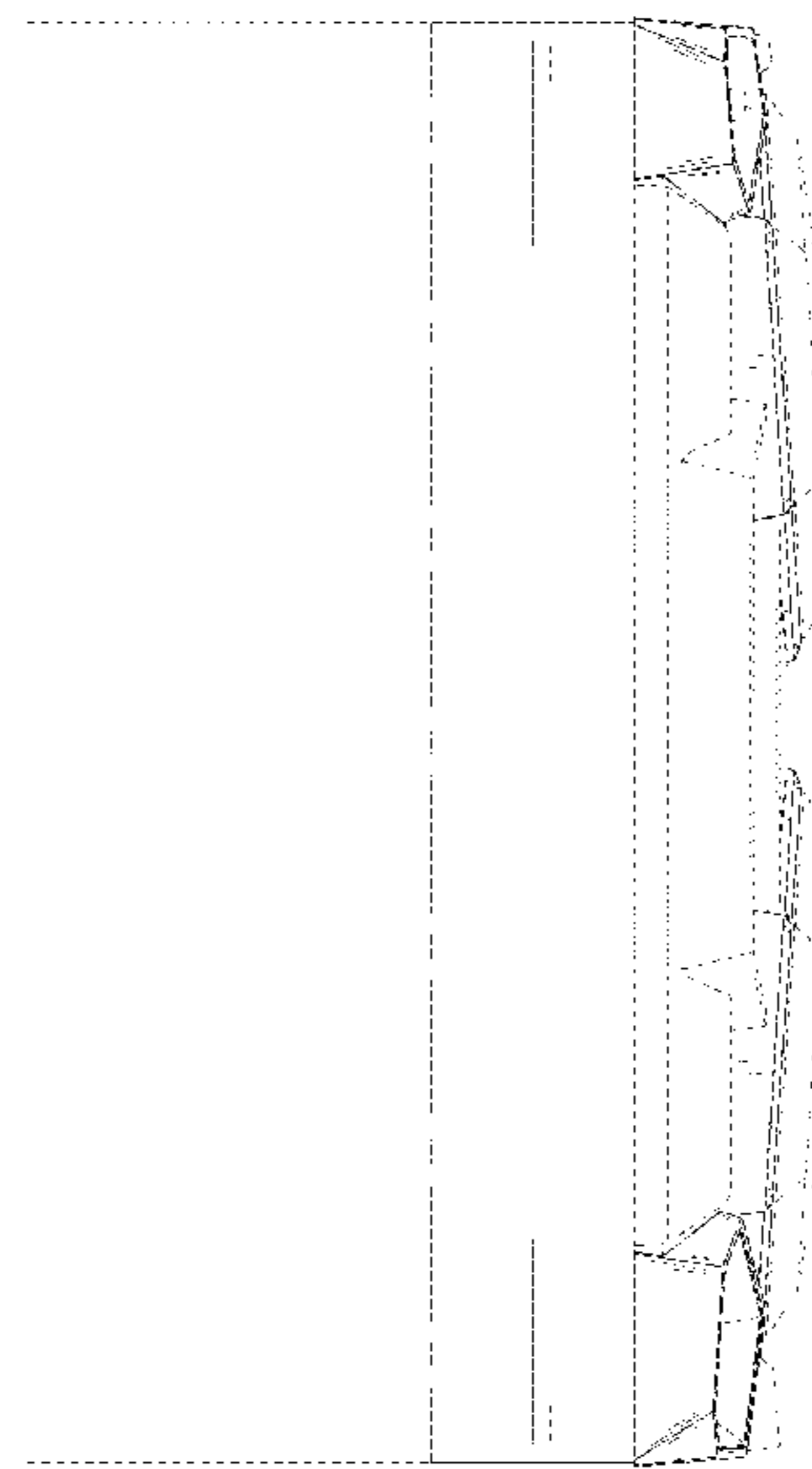
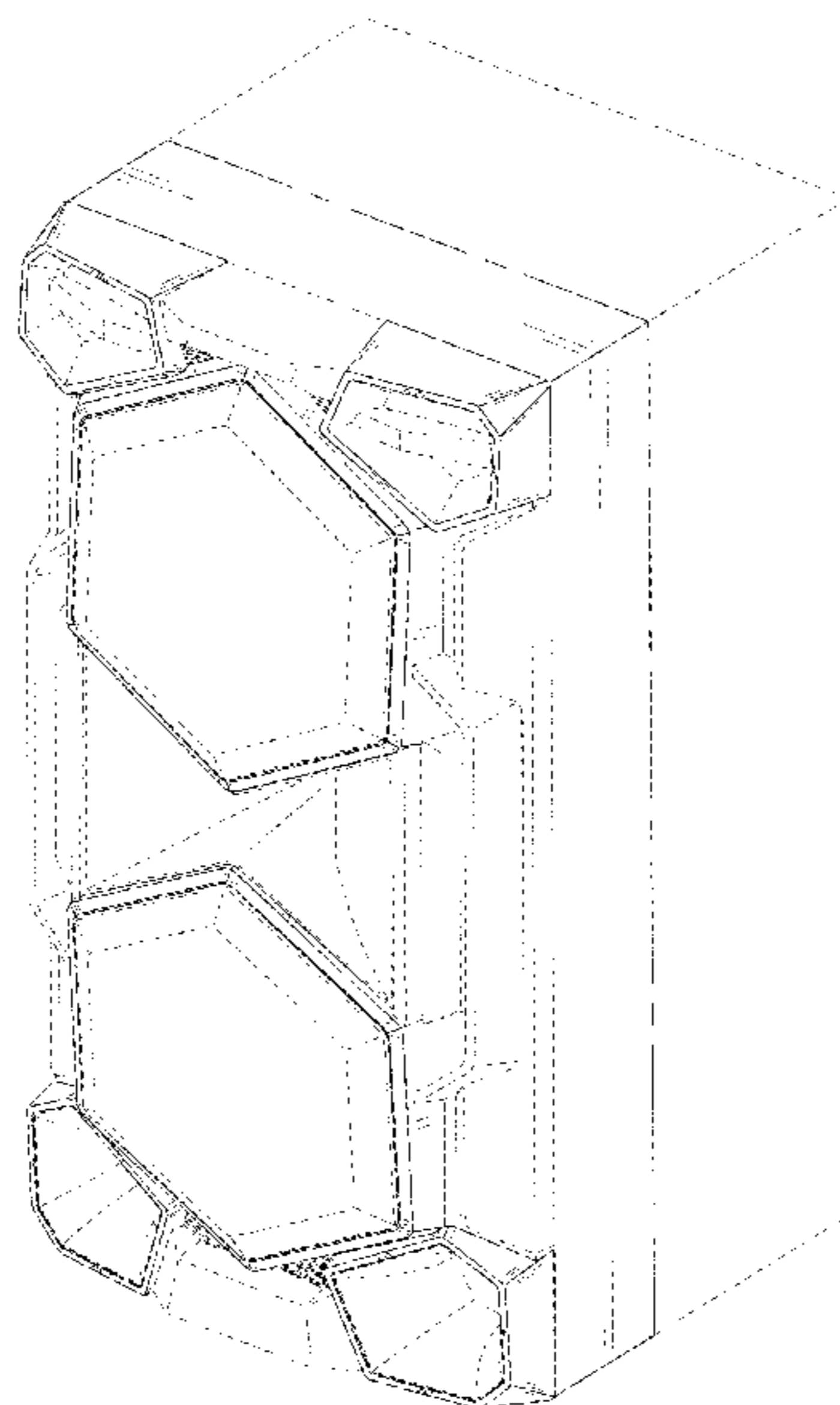

FIG. 1

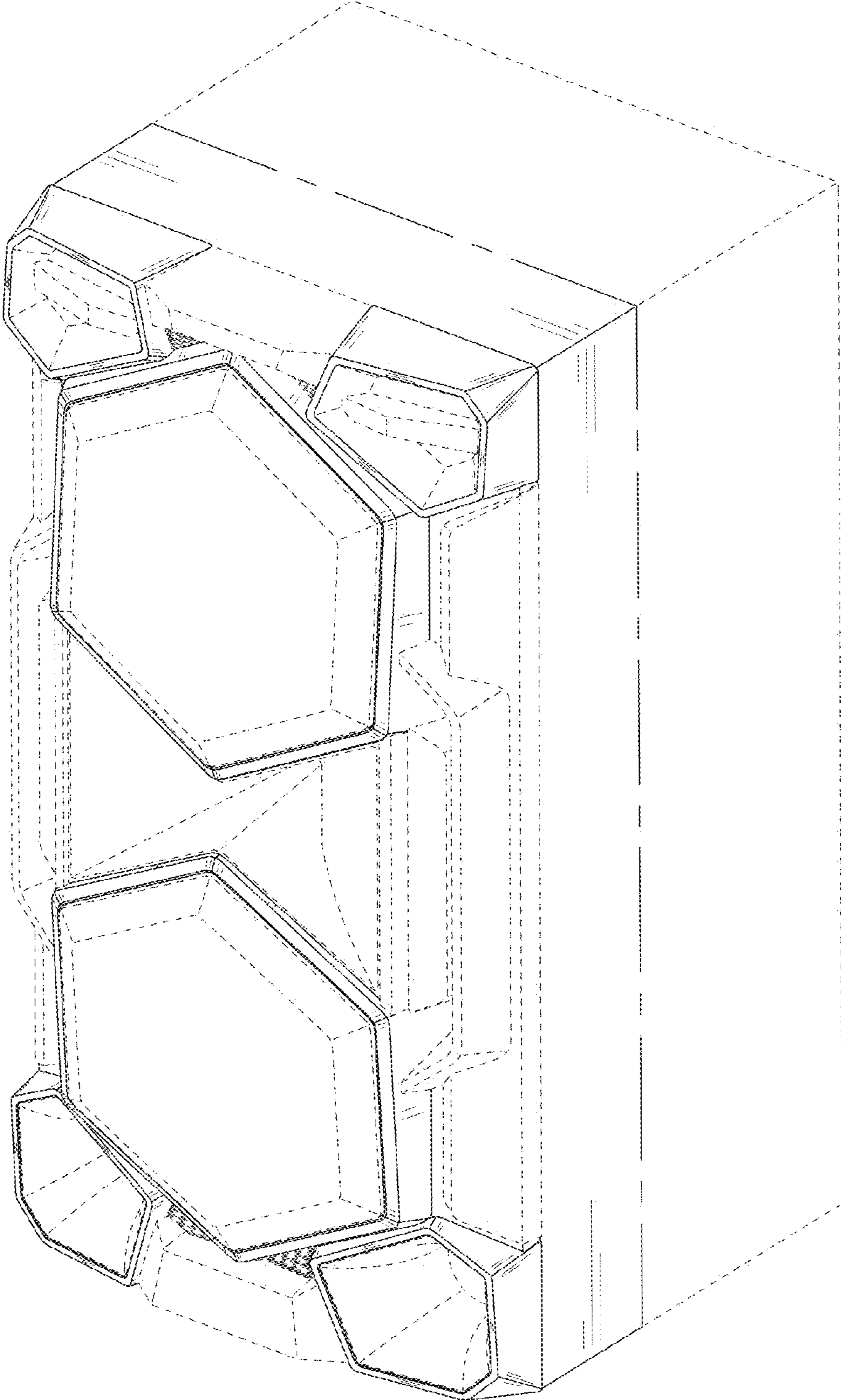

FIG. 2

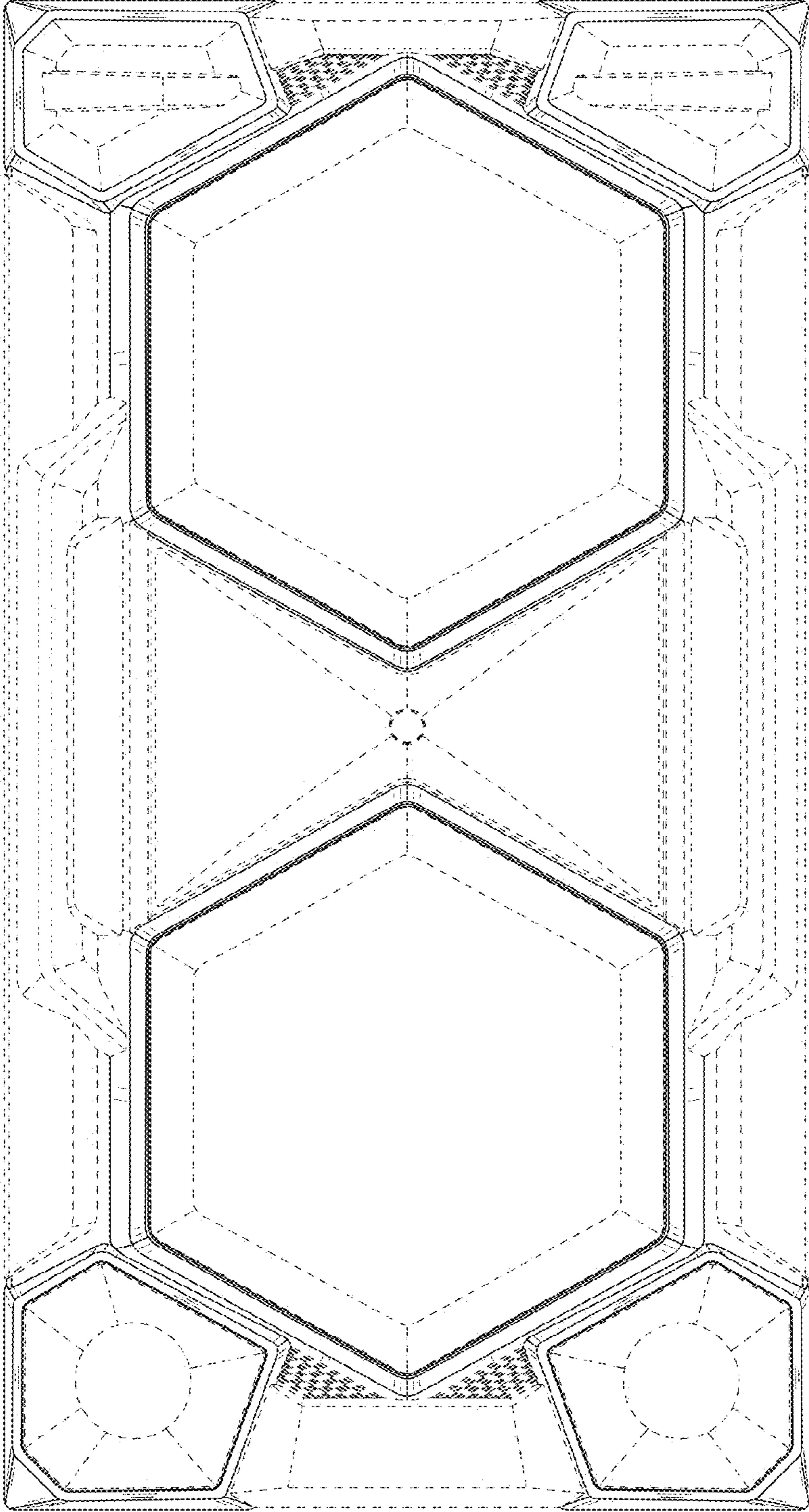

FIG. 3



FIG. 4

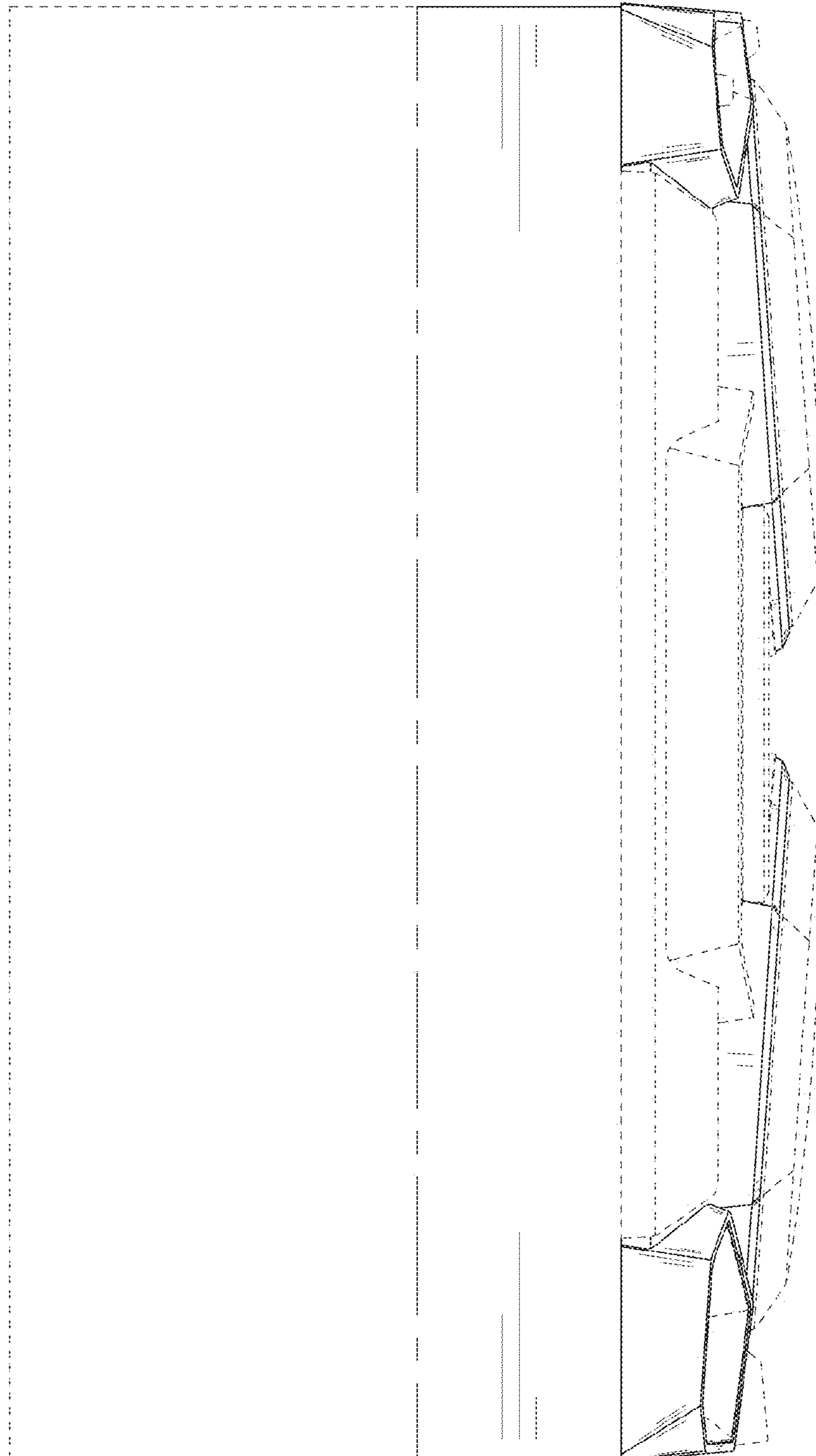

FIG. 5

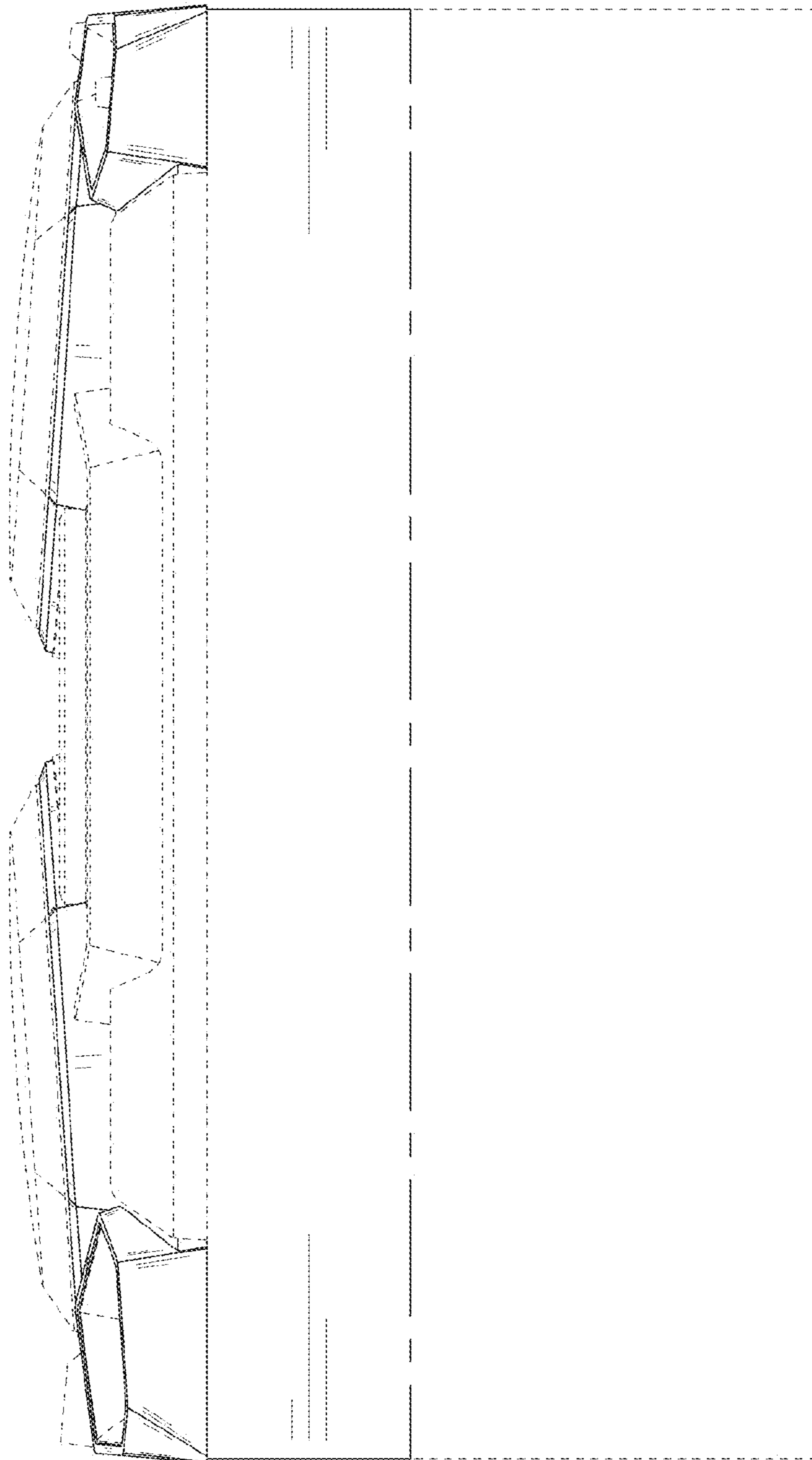

FIG. 6

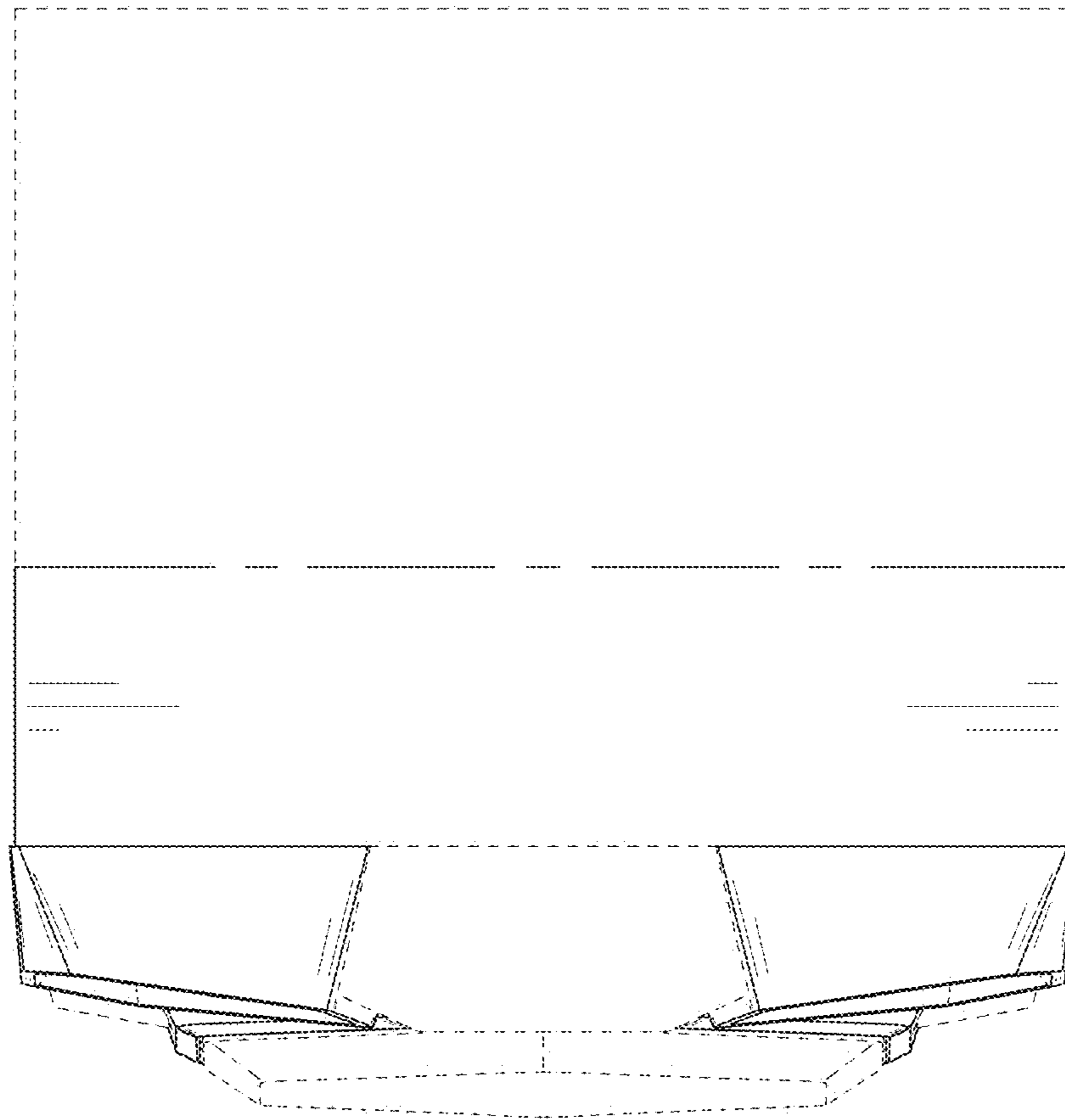

FIG. 7

