

US00D766205S

(12) **United States Design Patent**
Conti et al.

(10) **Patent No.:** **US D766,205 S**

(45) **Date of Patent:** **** Sep. 13, 2016**

(54) **SPEAKER HOUSING**

(71) Applicant: **Autodesk, Inc.**, San Rafael, CA (US)

(72) Inventors: **Maurice Ugo Conti**, Muir Beach, CA (US); **Charlott Sophie Vallon**, Berkeley, CA (US)

(73) Assignee: **AUTODESK, INC.**, San Rafael, CA (US)

(**) Term: **14 Years**

(21) Appl. No.: **29/482,202**

(22) Filed: **Feb. 14, 2014**

(51) **LOC (10) Cl.** **14-01**

(52) **U.S. Cl.**
USPC **D14/204**

(58) **Field of Classification Search**

USPC D10/1, 15, 18, 19, 21, 22, 24, 25, 27, D10/28; D14/167-169, 170-172, 176, 188, D14/189, 194-197, 200, 203.1-203.6, 204, D14/207, 214-216, 496, 508; D26/28, 30, D26/32, 35, 36; 181/143, 144, 147, 148, 181/150, 153, 157, 198, 199; 381/300-302, 381/336, 345, 361-364, 386-388
CPC H04R 1/02; H04R 1/021; H04R 1/023; H04R 5/00; H04R 9/06; H04R 2420/07
See application file for complete search history.

(56) **References Cited**

U.S. PATENT DOCUMENTS

D425,510 S * 5/2000 Dietz et al. D14/214
D458,396 S * 6/2002 Grove D26/28

D498,229 S * 11/2004 Allen D14/211
D511,583 S * 11/2005 Tanaka et al. D26/28
D547,746 S * 7/2007 Allen D14/211
D548,860 S * 8/2007 Wang D26/28
D606,215 S * 12/2009 May D26/28
D636,372 S * 4/2011 Leung D14/168

* cited by examiner

Primary Examiner — Derrick Holland

Assistant Examiner — Janice Lim

(74) *Attorney, Agent, or Firm* — Artegis Law Group, LLP

(57) **CLAIM**

The ornamental design for a speaker housing, as shown and described.

DESCRIPTION

FIG. 1 is a top perspective view of a speaker housing showing our new design;
FIG. 2 is a bottom perspective view thereof;
FIG. 3 is a front elevational view thereof;
FIG. 4 is a rear elevational view thereof;
FIG. 5 is a left side elevational view thereof;
FIG. 6 is a right side elevational view thereof;
FIG. 7 is a top plan view thereof; and,
FIG. 8 is a bottom plan view thereof.
The broken line portions of FIGS. 1-3 are included to show unclaimed subject matter only and form no part of the claimed design.

1 Claim, 8 Drawing Sheets

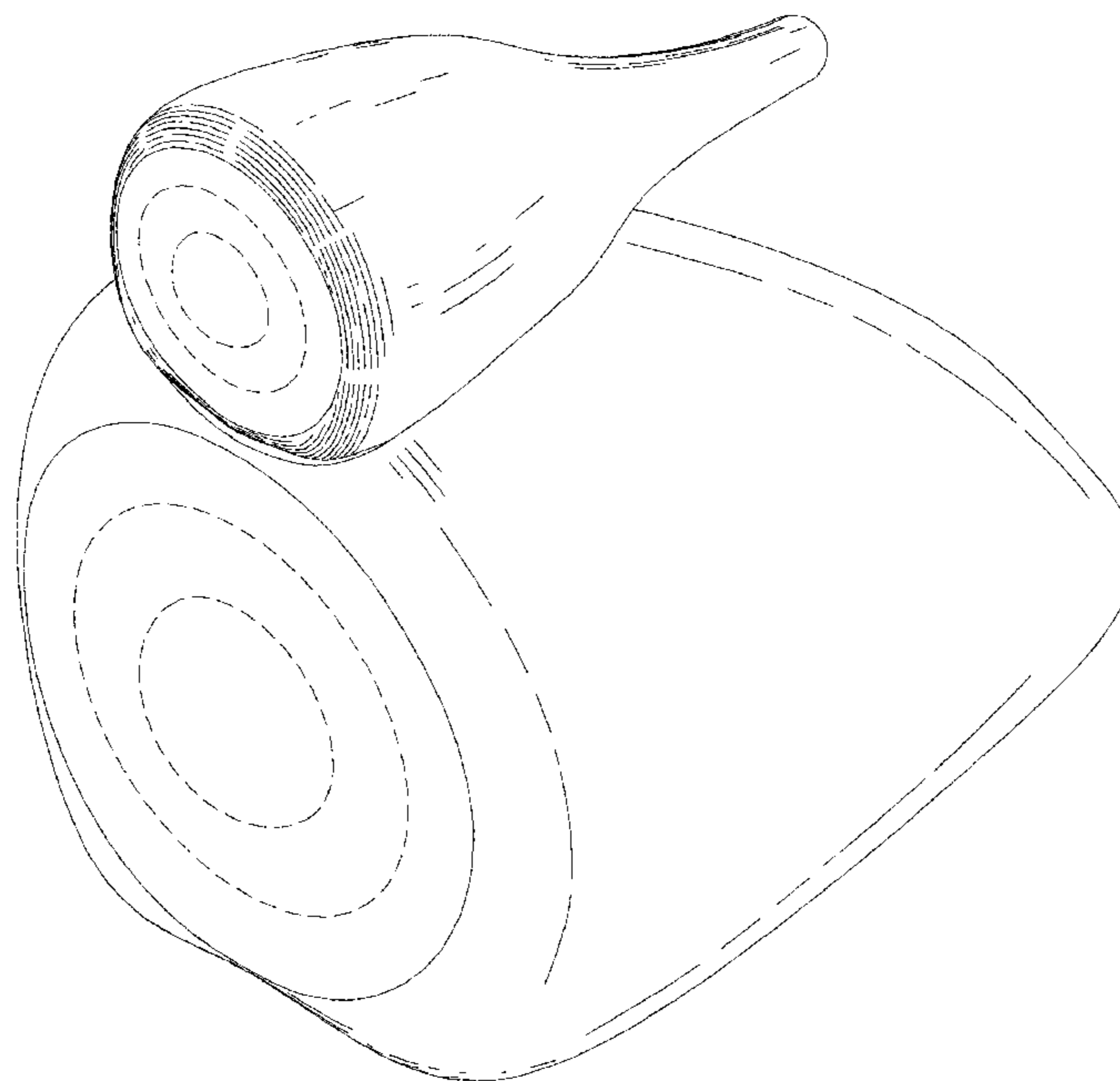

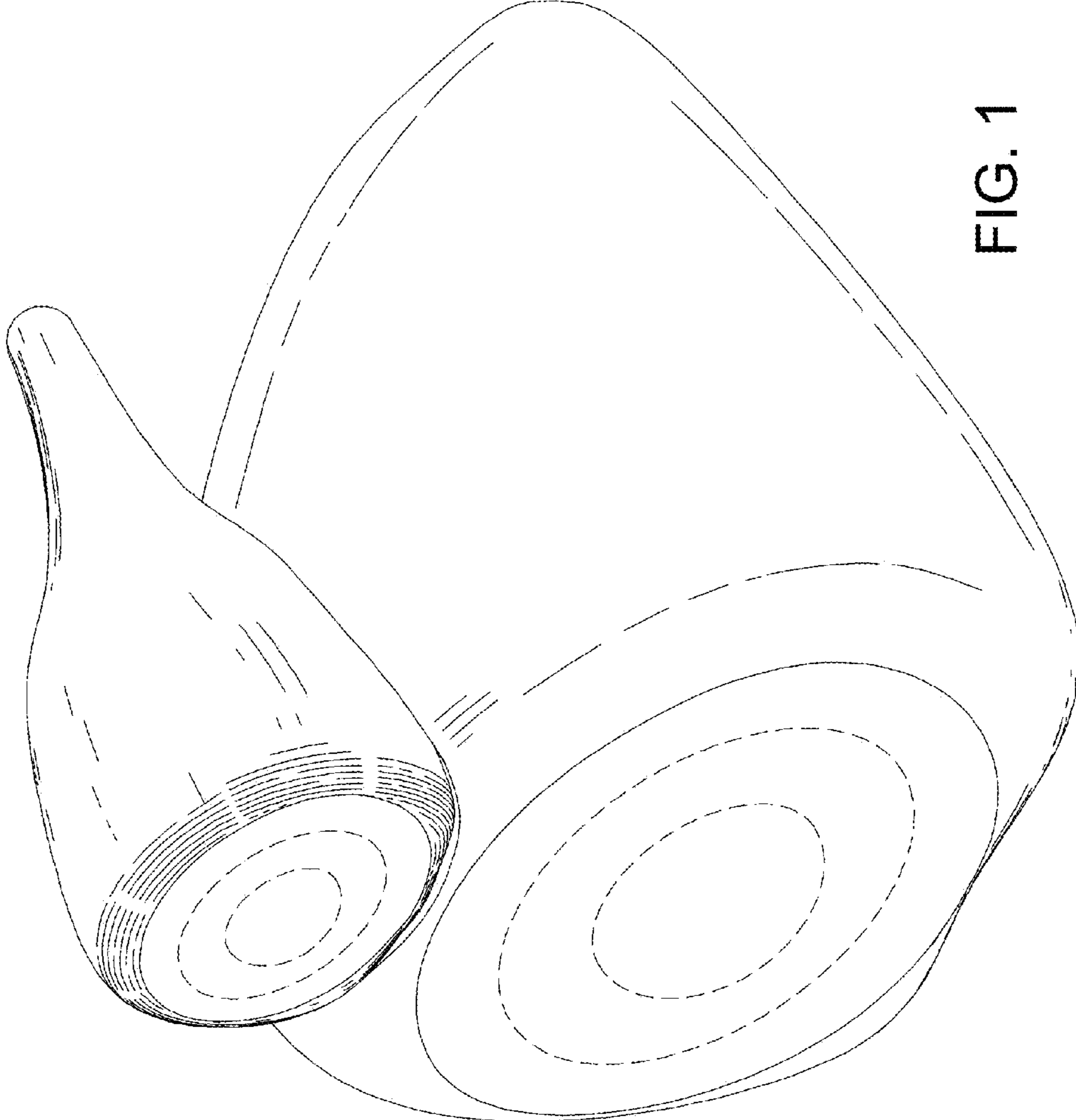

FIG. 1

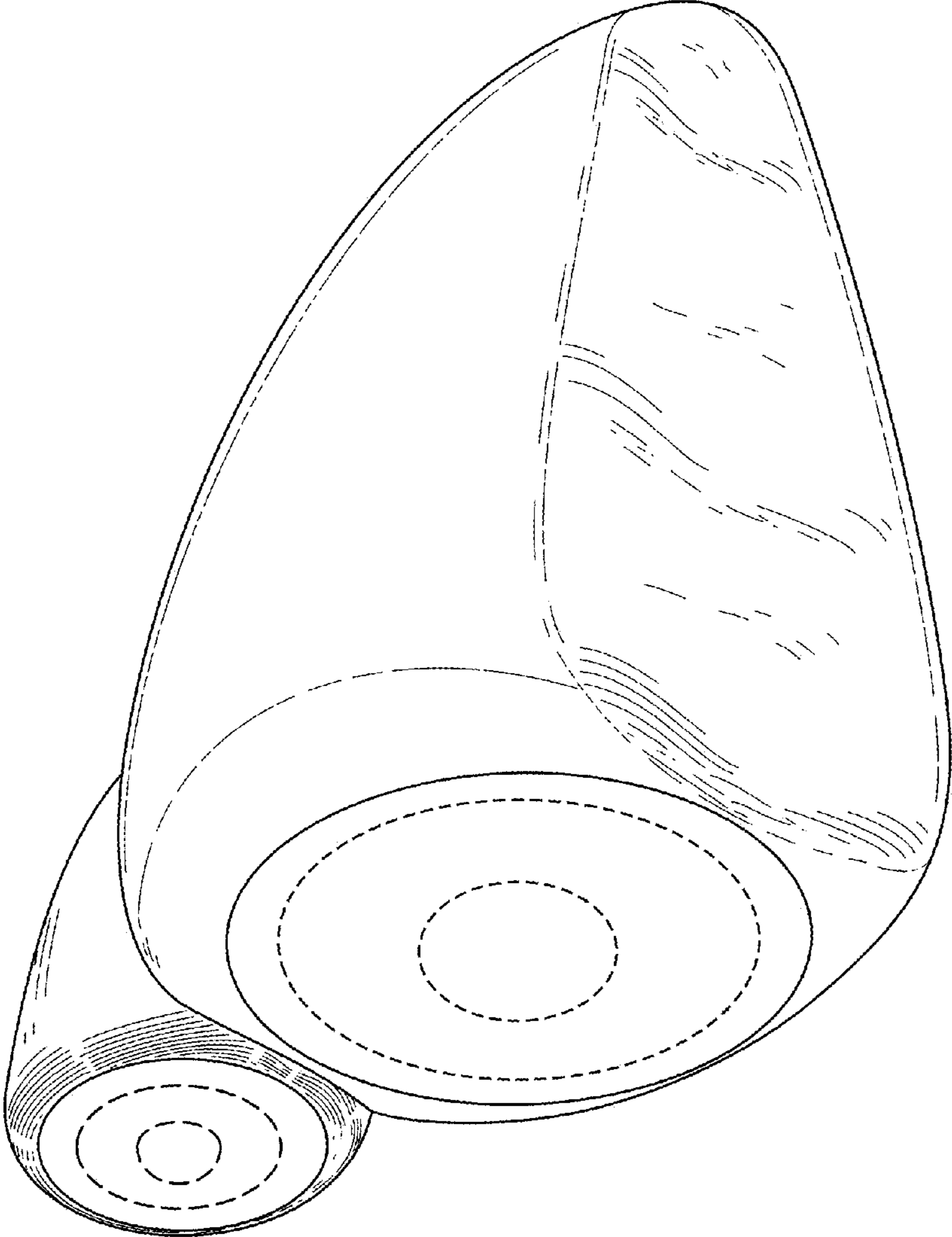

FIG. 2

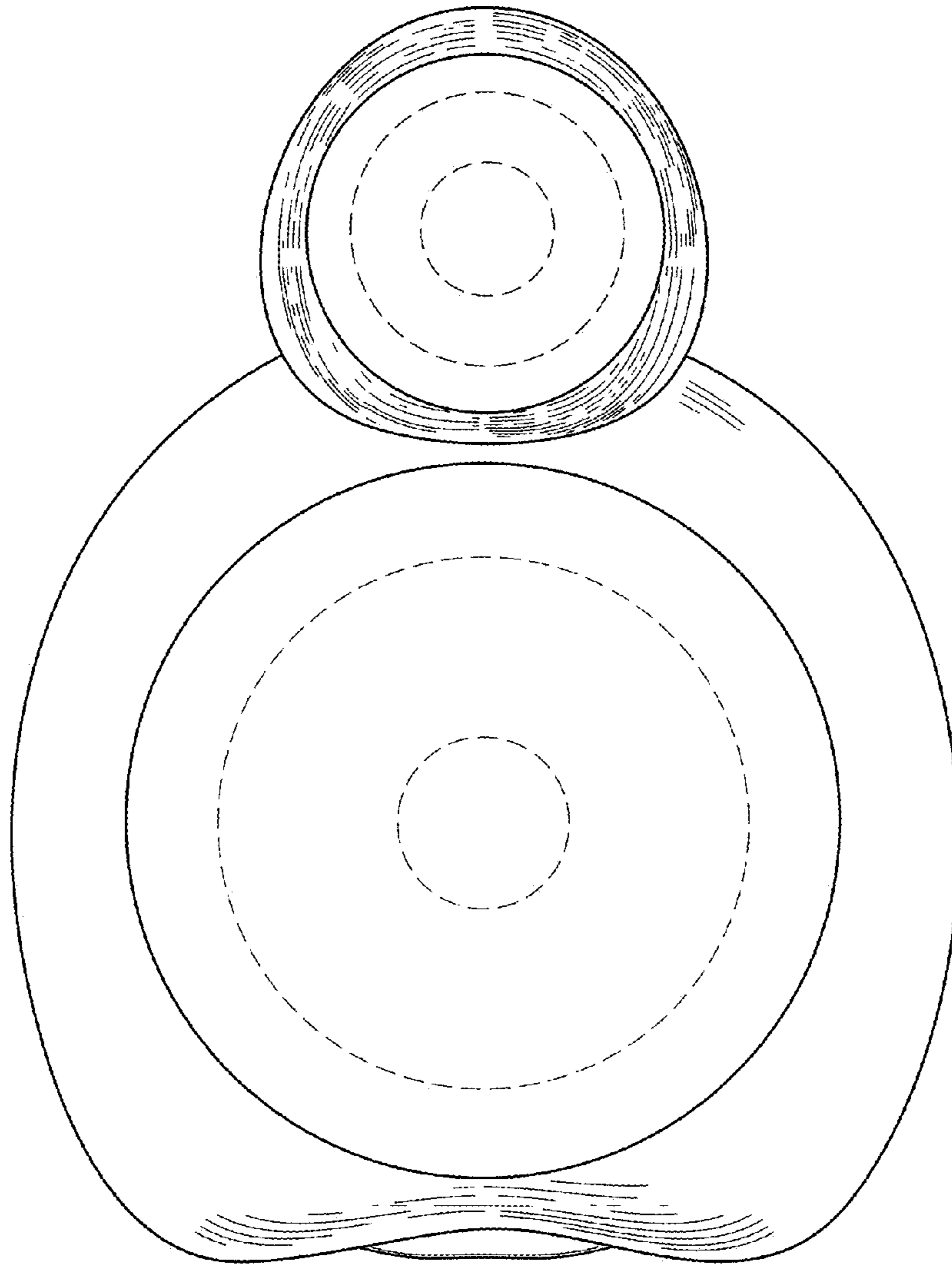

FIG. 3

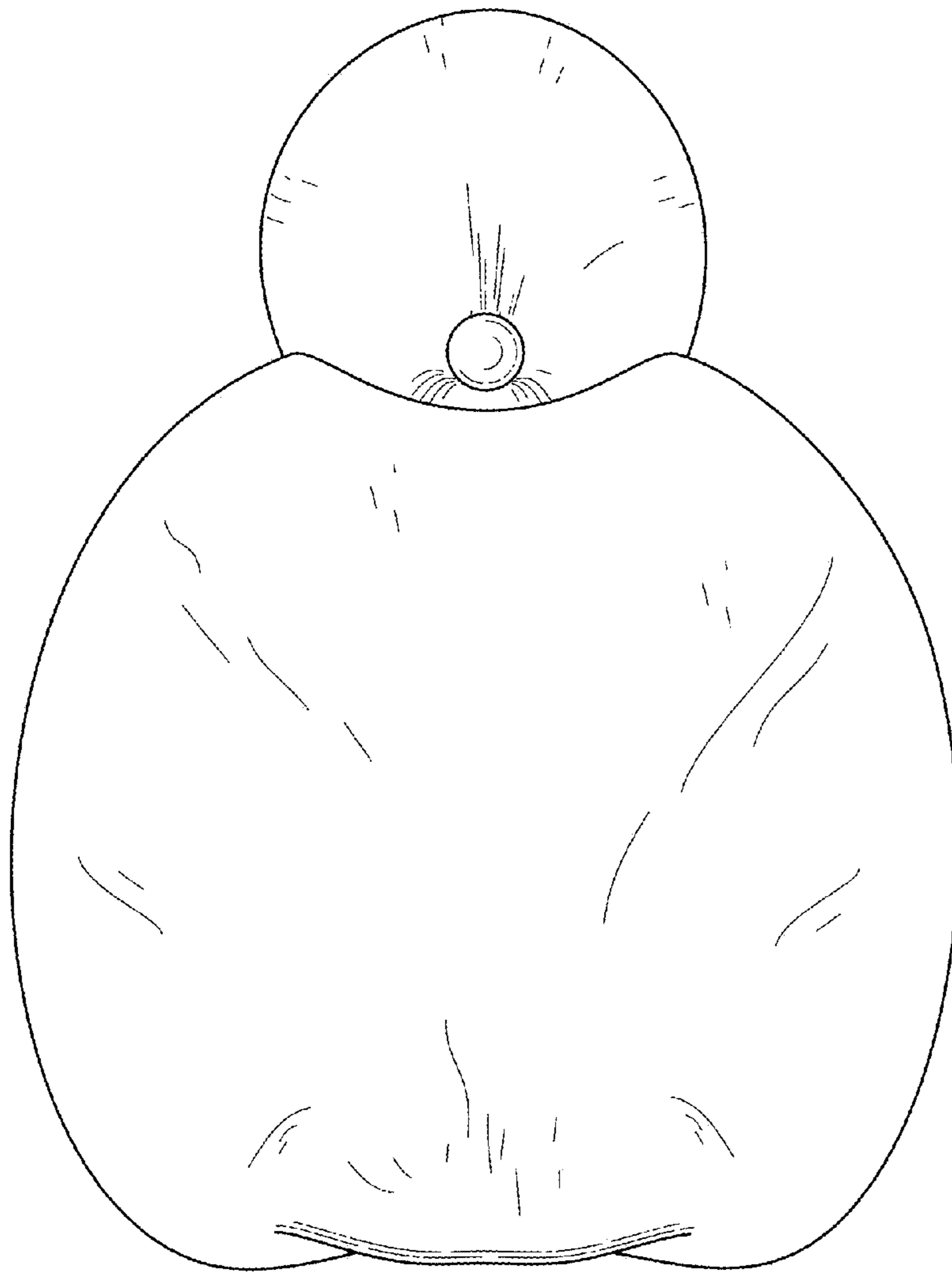

FIG. 4

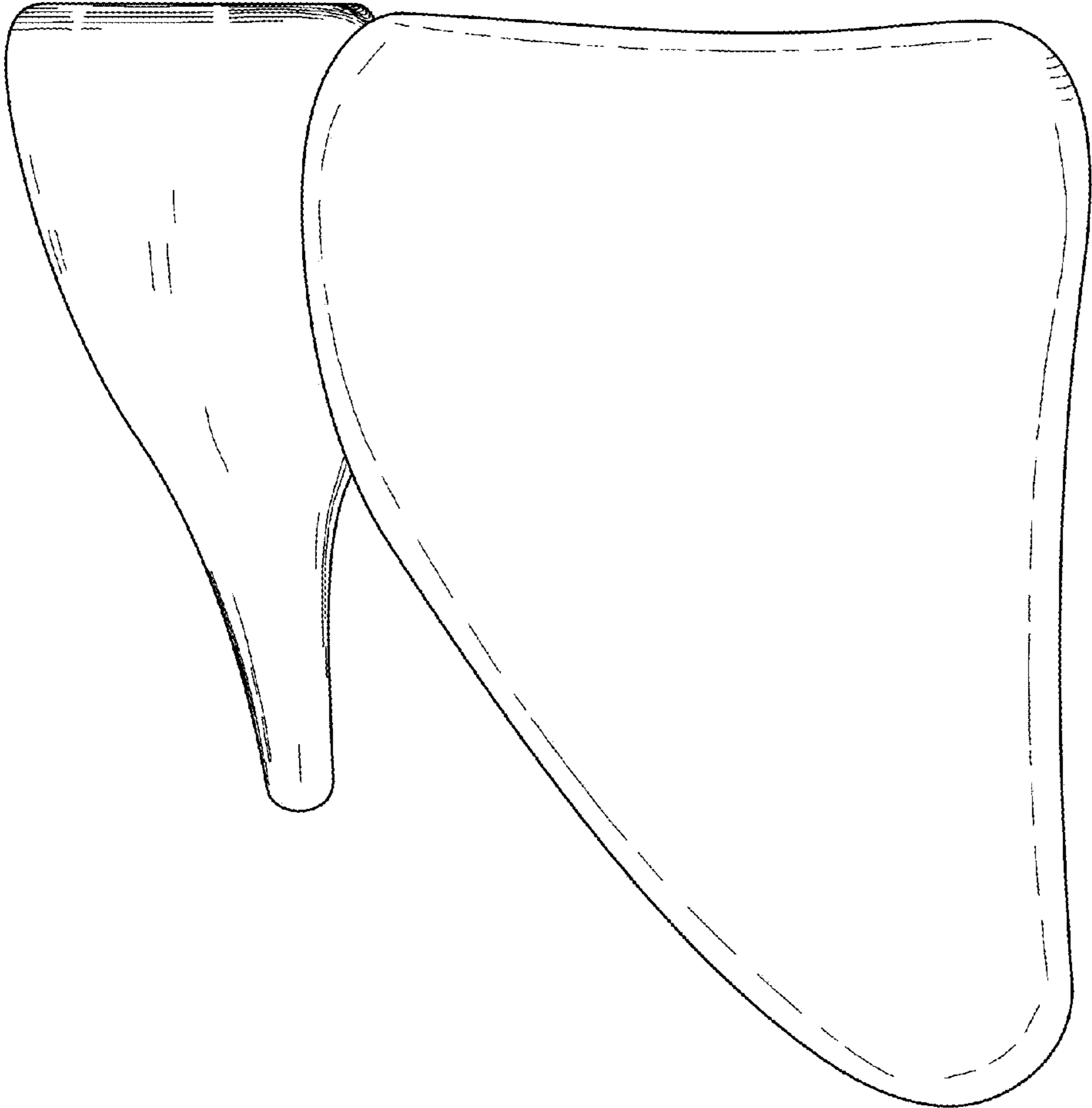

FIG. 5

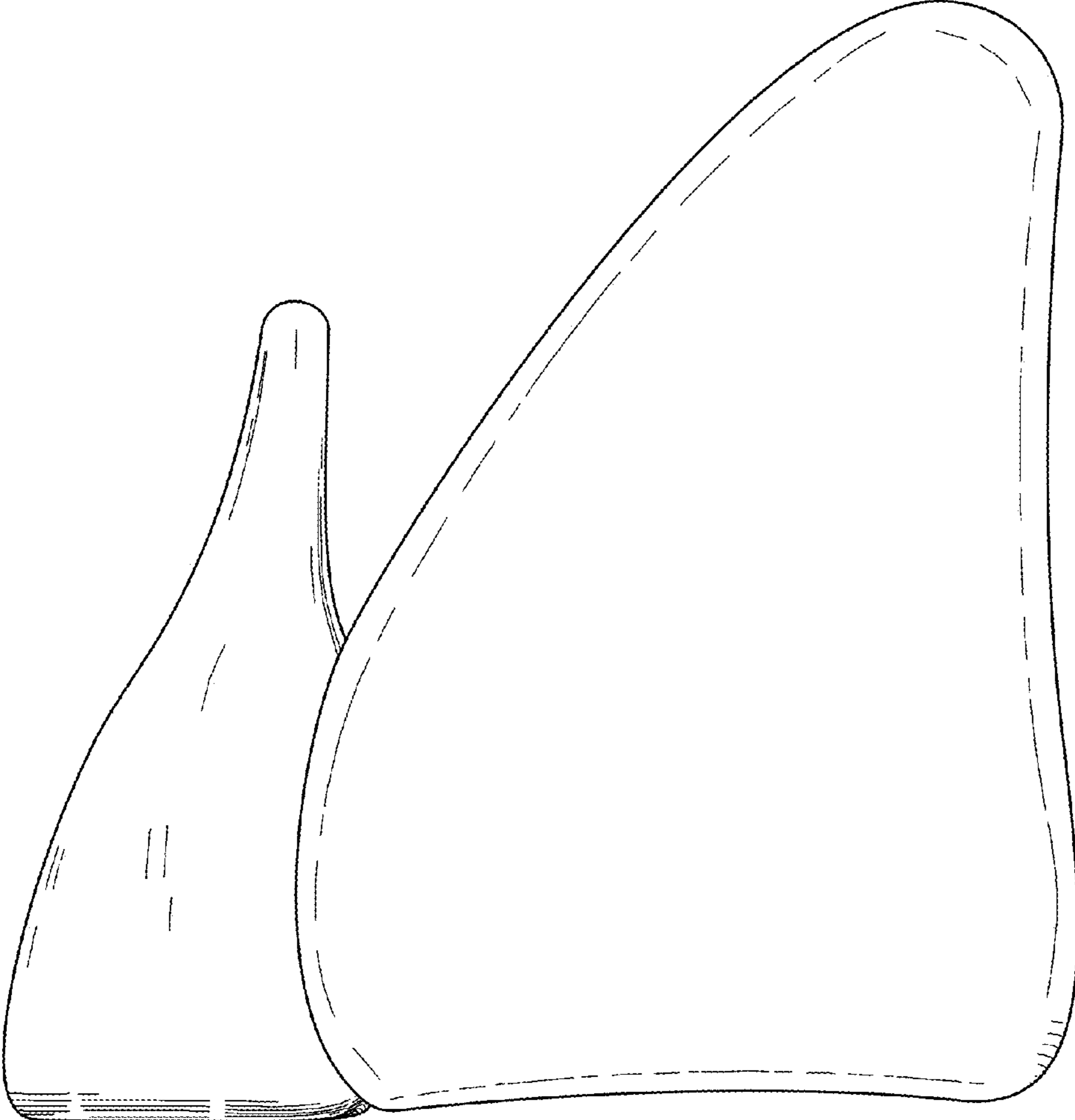

FIG. 6

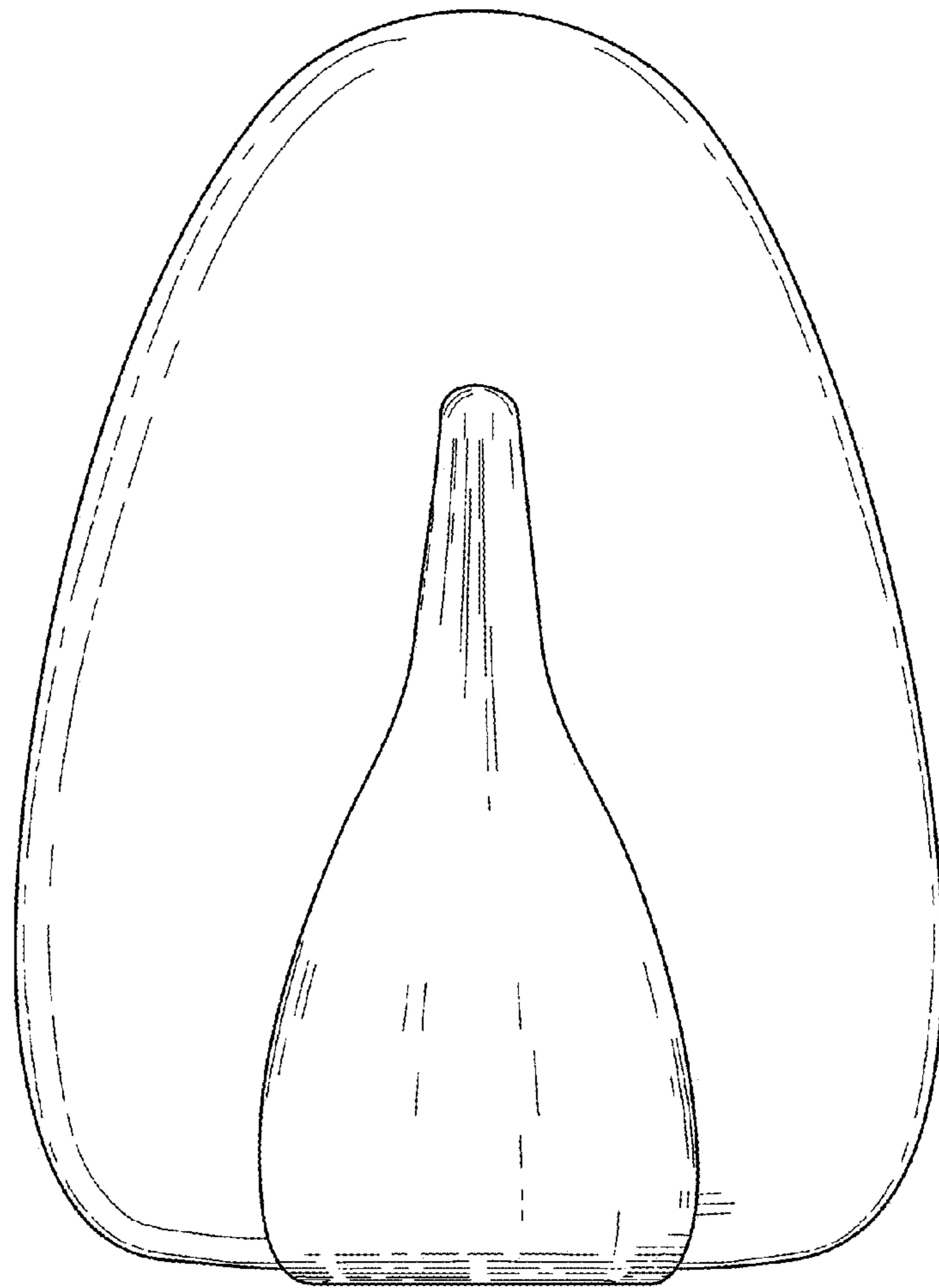

FIG. 7

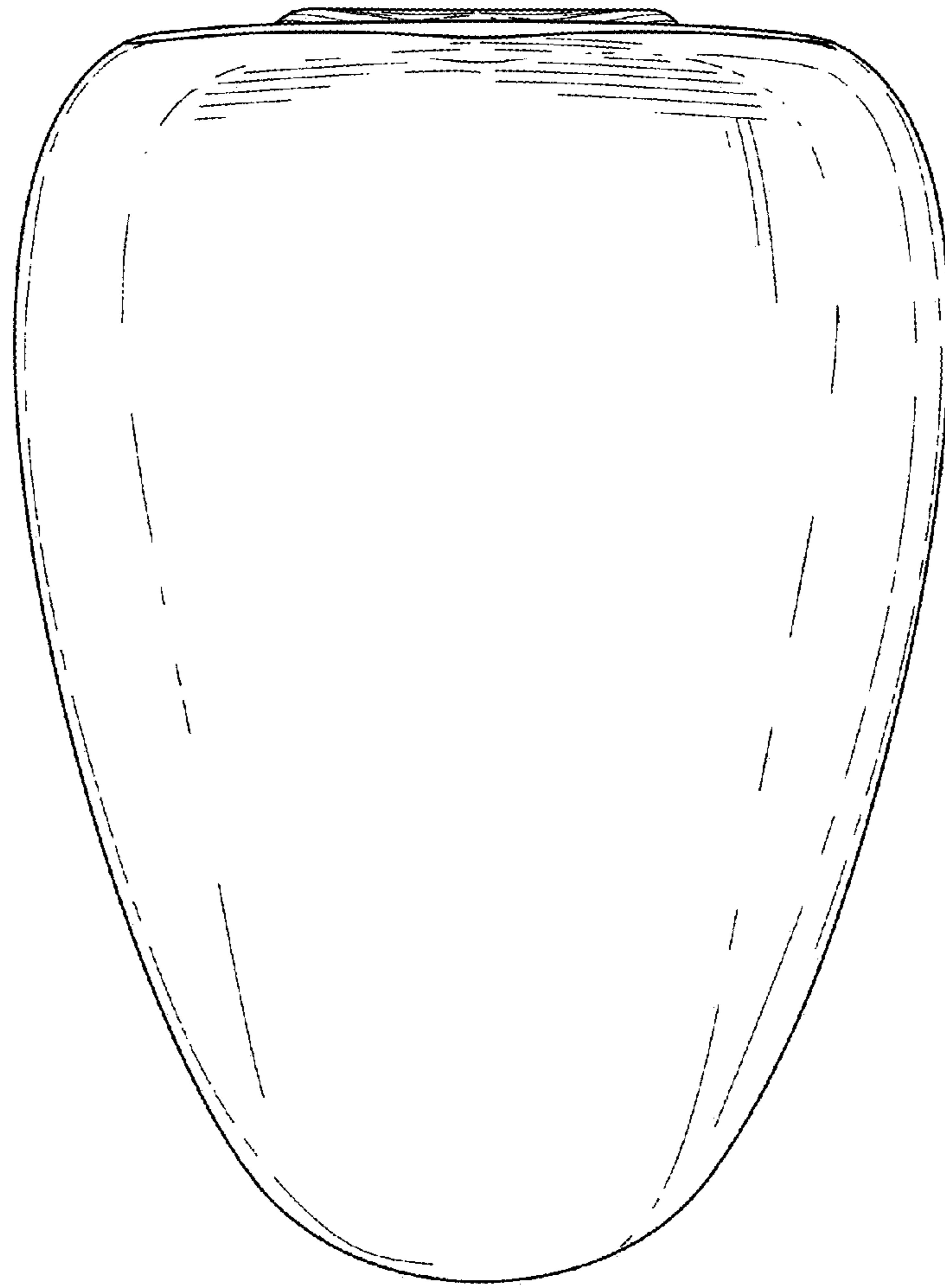

FIG. 8

UNITED STATES PATENT AND TRADEMARK OFFICE
CERTIFICATE OF CORRECTION

PATENT NO. : D766,205 S
APPLICATION NO. : 29/482202
DATED : September 13, 2016
INVENTOR(S) : Maurice Ugo Conti and Charlott Sophie Vallon

Page 1 of 1

It is certified that error appears in the above-identified patent and that said Letters Patent is hereby corrected as shown below:

On the Title Page

(56) References Cited:

Please insert --CN 301083858 D * 12/2009--.

Signed and Sealed this
Twenty-ninth Day of August, 2017



Joseph Matal
*Performing the Functions and Duties of the
Under Secretary of Commerce for Intellectual Property and
Director of the United States Patent and Trademark Office*