



US00D766181S

(12) **United States Design Patent**
Cooper

(10) **Patent No.:** **US D766,181 S**

(45) **Date of Patent:** **** Sep. 13, 2016**

- (54) **BATTERY HOLDER**
- (71) Applicant: **Wilmar Corporation**, Renton, WA
(US)
- (72) Inventor: **David James Cooper**, Renton, WA
(US)
- (73) Assignee: **Wilmar Corporation**, Renton, WA
(US)
- (**) Term: **14 Years**
- (21) Appl. No.: **29/523,683**
- (22) Filed: **Apr. 13, 2015**
- (51) **LOC (10) Cl.** **13-02**
- (52) **U.S. Cl.**
USPC **D13/119**
- (58) **Field of Classification Search**
USPC D13/102–106, 110, 118–119, 184, 199;
D14/203.3–203.8, 217, 240, 248,
D14/250–253, 432, 434, 440, 450, 496;
D21/769; D3/201, 218, 269, 301, 273,
D3/303; 429/96–100, 149, 159, 163, 176,
429/177, 186; 206/703–705, 461–463, 471,
206/485, 485.1, 493; 320/101, 102,
320/107–115, 120; 361/679.56; 379/426,
379/433.11–433.13, 455; 441/74;
455/575.1, 575.8
CPC ... Y02E 60/12; Y02E 60/122; Y02E 60/124;
Y02E 60/50; H01M 2/02; H01M 2/022;
H01M 2/0202; H01M 2/0207; H01M 2/0212;
H01M 2/1061; H01M 2/1022; H01M 2/1055;
H01M 2/1066; H01M 2/105; H01M 2/204;
H01M 10/4257; H01M 10/0436; H01M
10/48
See application file for complete search history.

(56) **References Cited**

U.S. PATENT DOCUMENTS

6,440,601 B1 * 8/2002 Aoi H01M 2/105
429/100

6,531,244 B1 * 3/2003 Ryan, Jr. H01M 2/105
429/100
7,678,499 B2 * 3/2010 Shiau H01M 2/0257
429/163
D637,156 S * 5/2011 Yoon D13/119
D664,092 S * 7/2012 Gea Suarez D13/103
D676,379 S * 2/2013 Liu D13/108
D710,305 S * 8/2014 Windom D13/119
2008/0166629 A1 * 7/2008 Shiau H01M 2/0257
429/169
2010/0231142 A1 * 9/2010 Yoon F21L 4/027
315/312
2010/0266893 A1 * 10/2010 Martin H01M 2/04
429/163

* cited by examiner

Primary Examiner — Rosemary K Tarcza

Assistant Examiner — Christy Nemeth

(74) *Attorney, Agent, or Firm* — Marc Baumgartner;
Baumgartner Patent Law

(57) **CLAIM**

The ornamental design for a battery holder, as shown and described.

DESCRIPTION

FIG. 1 is a perspective view of a battery holder embodying my new design;

FIG. 2 is a first side view of the battery holder thereof;

FIG. 3 is a second side view of the battery holder thereof;

FIG. 4 is a third side view of the battery holder thereof;

FIG. 5 is a fourth side view of the battery holder thereof;

FIG. 6 is a top view of the battery holder thereof; and,

FIG. 7 is a bottom view of the battery holder thereof.

The broken lines shown in the drawings illustrate unclaimed elements of the battery holder and form no part of the claimed design.

1 Claim, 2 Drawing Sheets

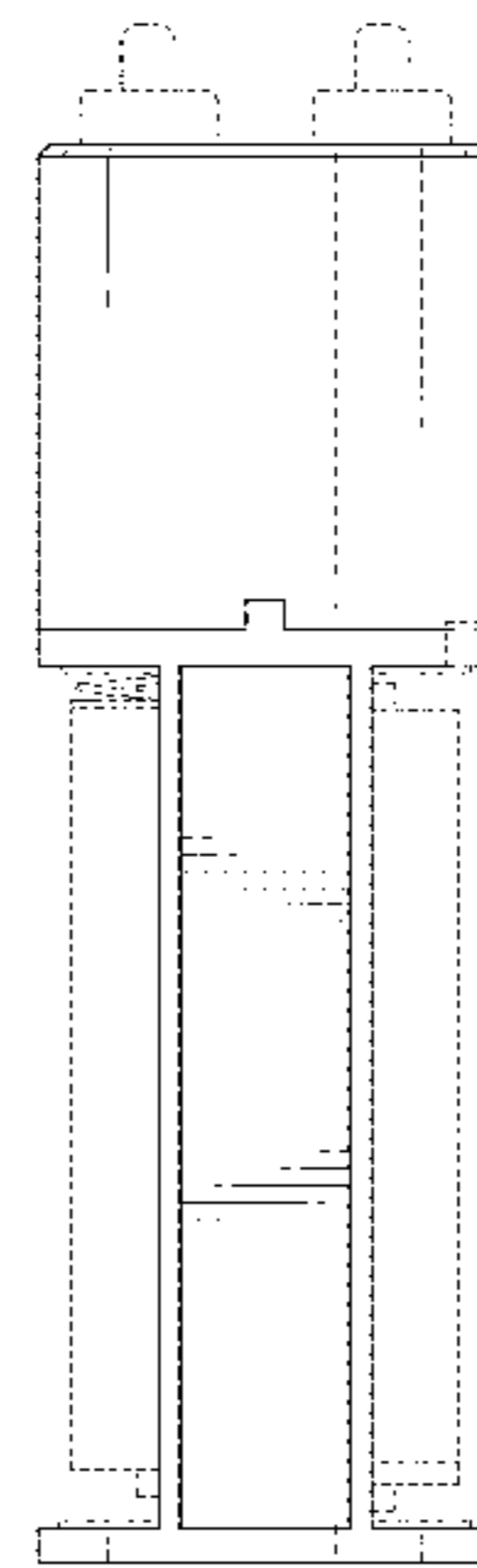
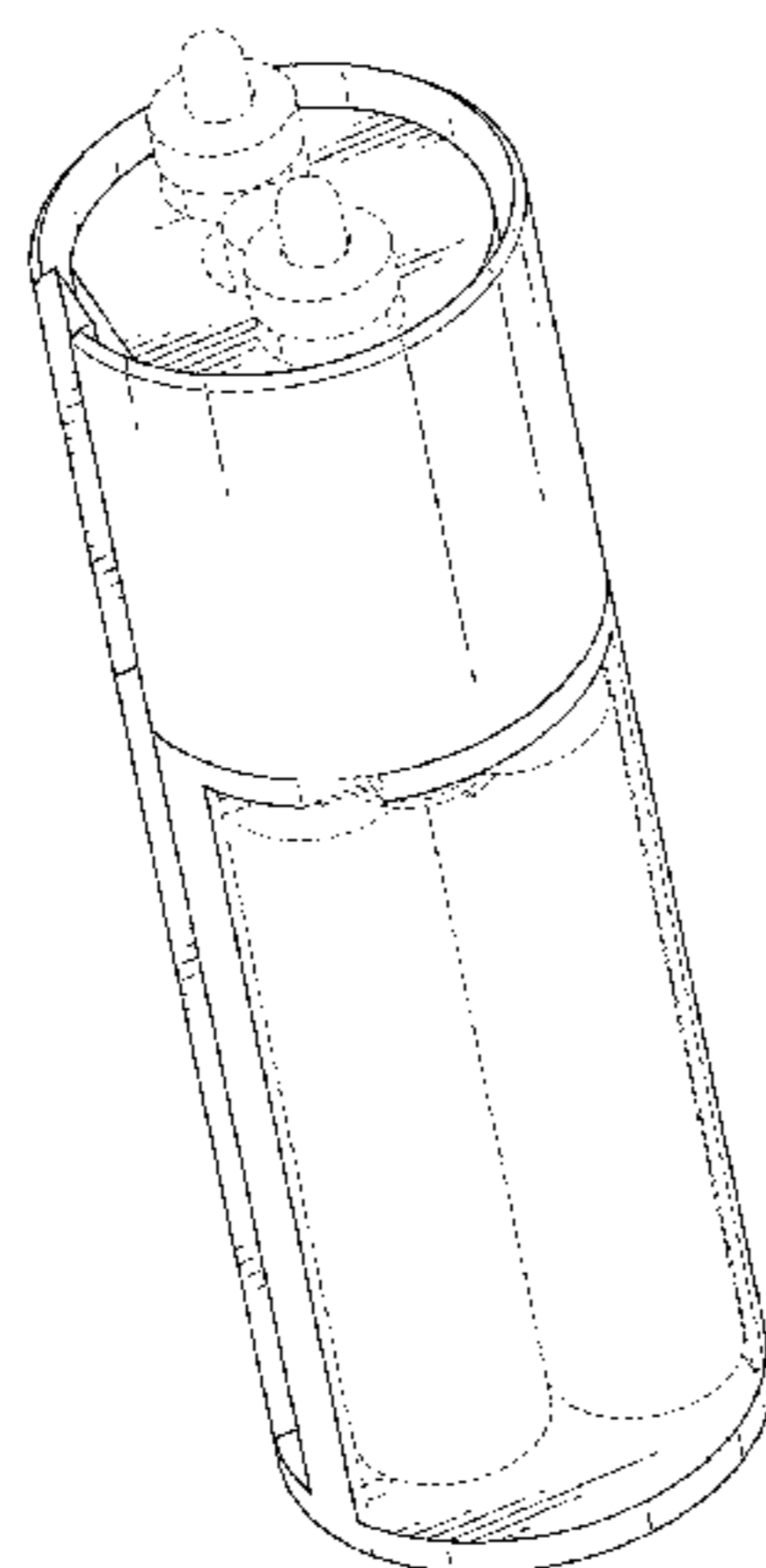

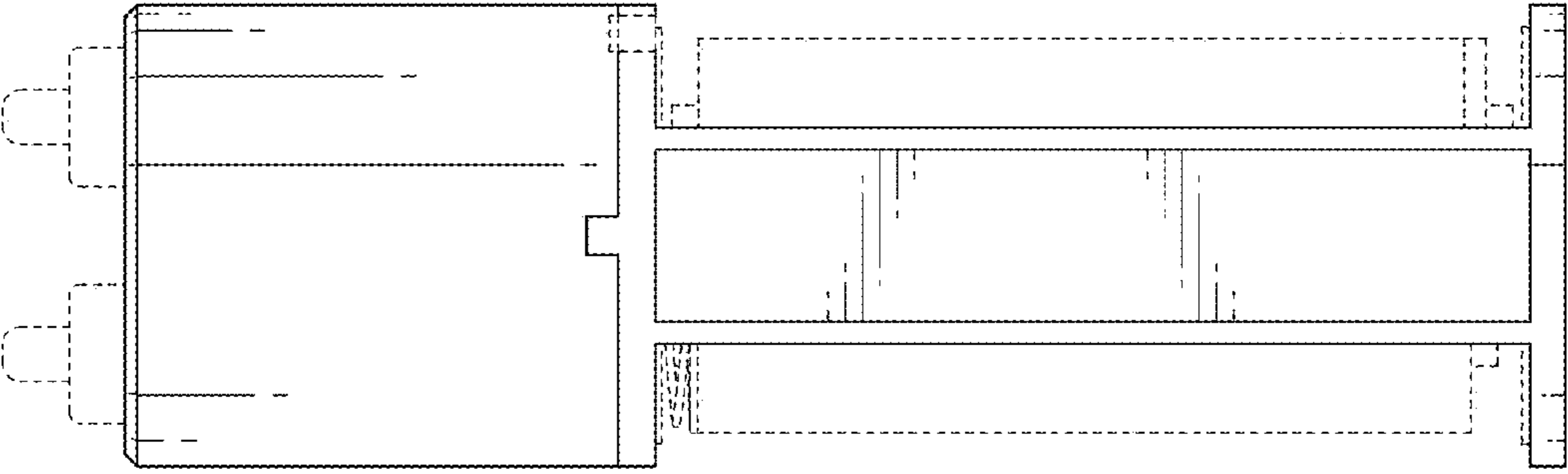

FIG. 3

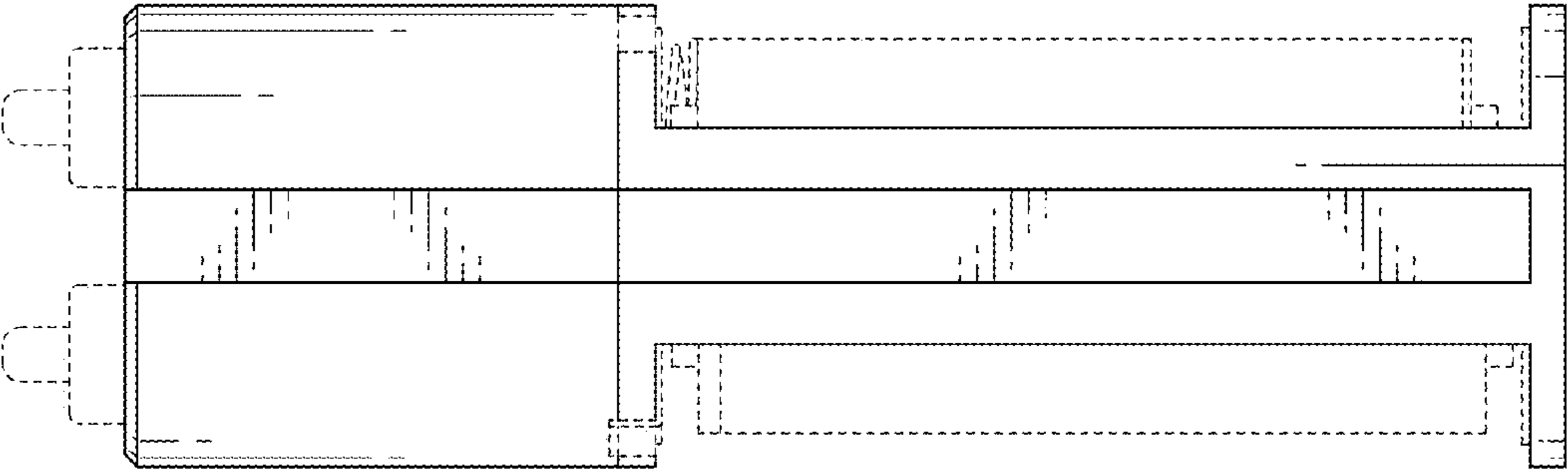

FIG. 2

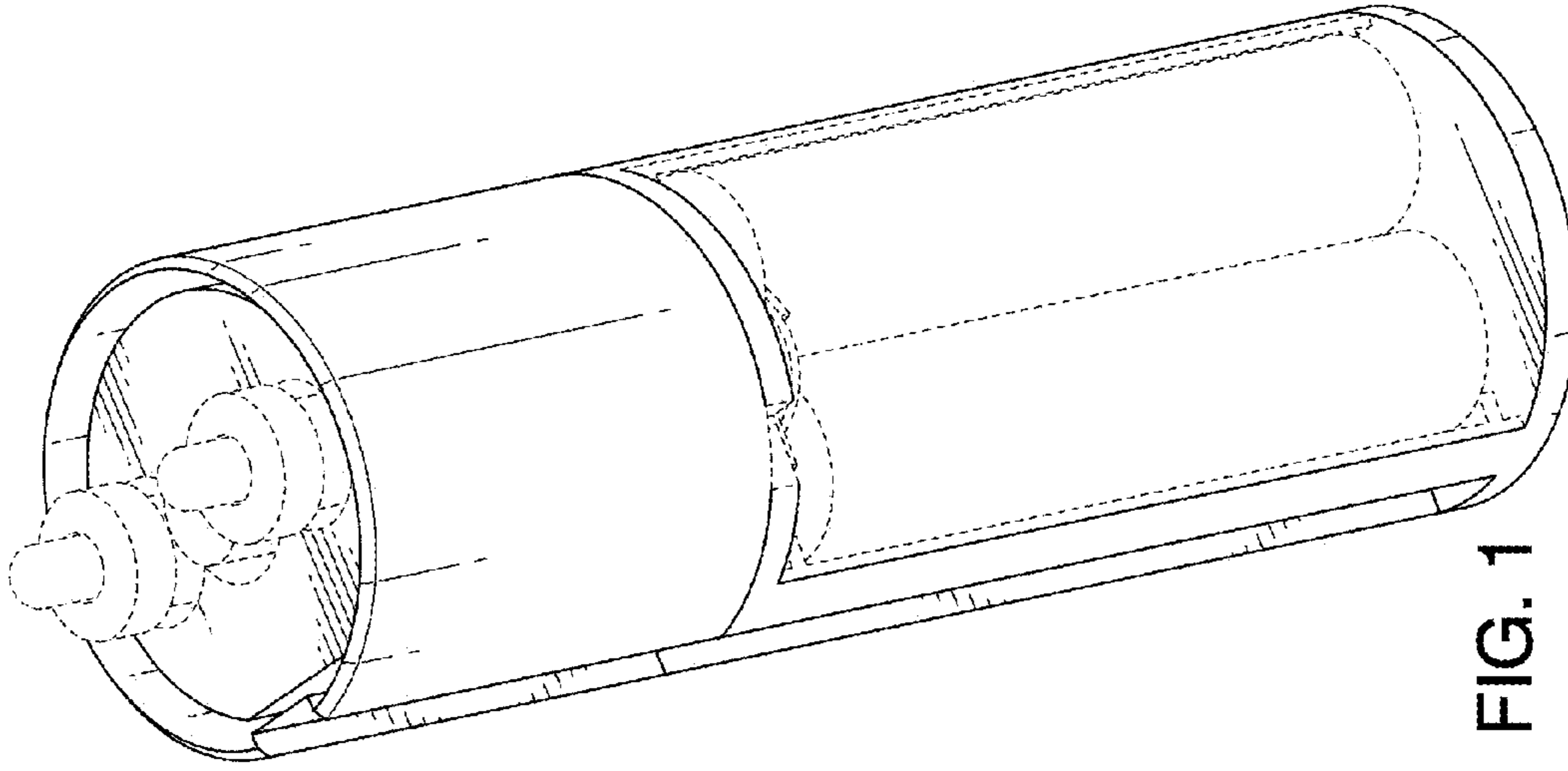

FIG. 1

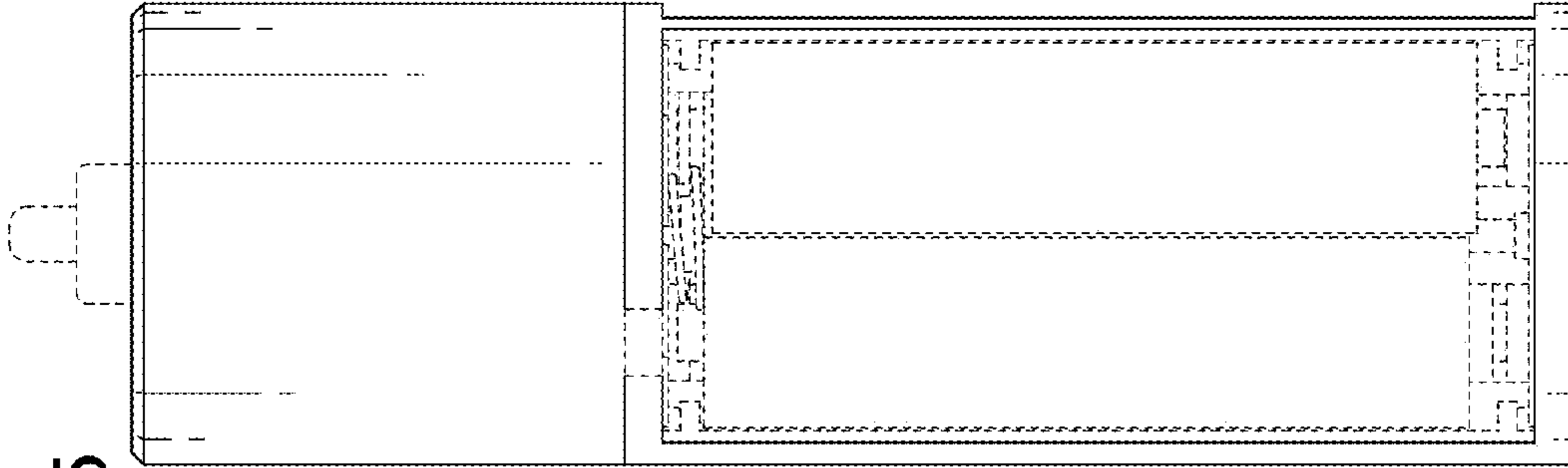

FIG. 4

FIG. 5

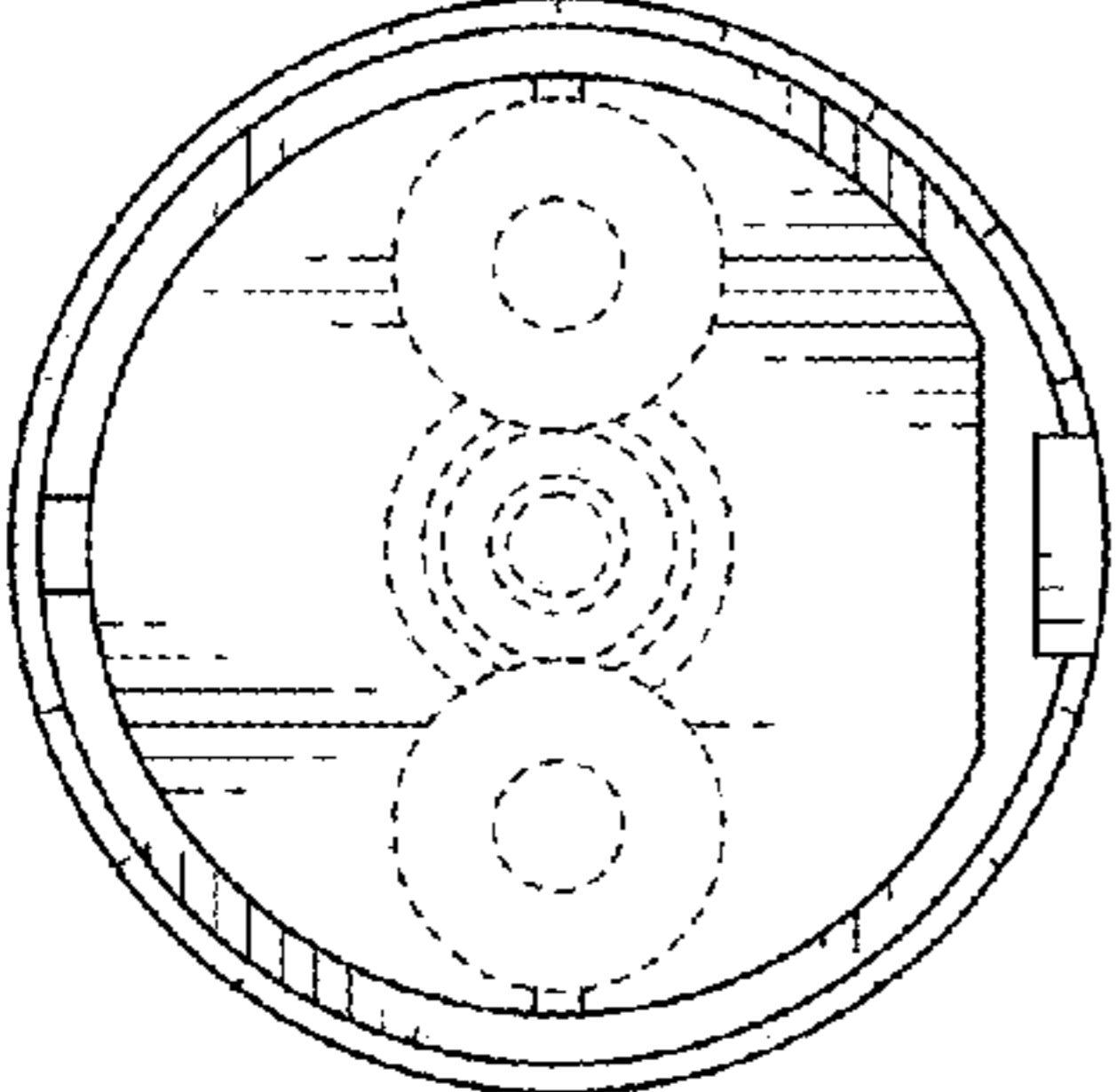

FIG. 6

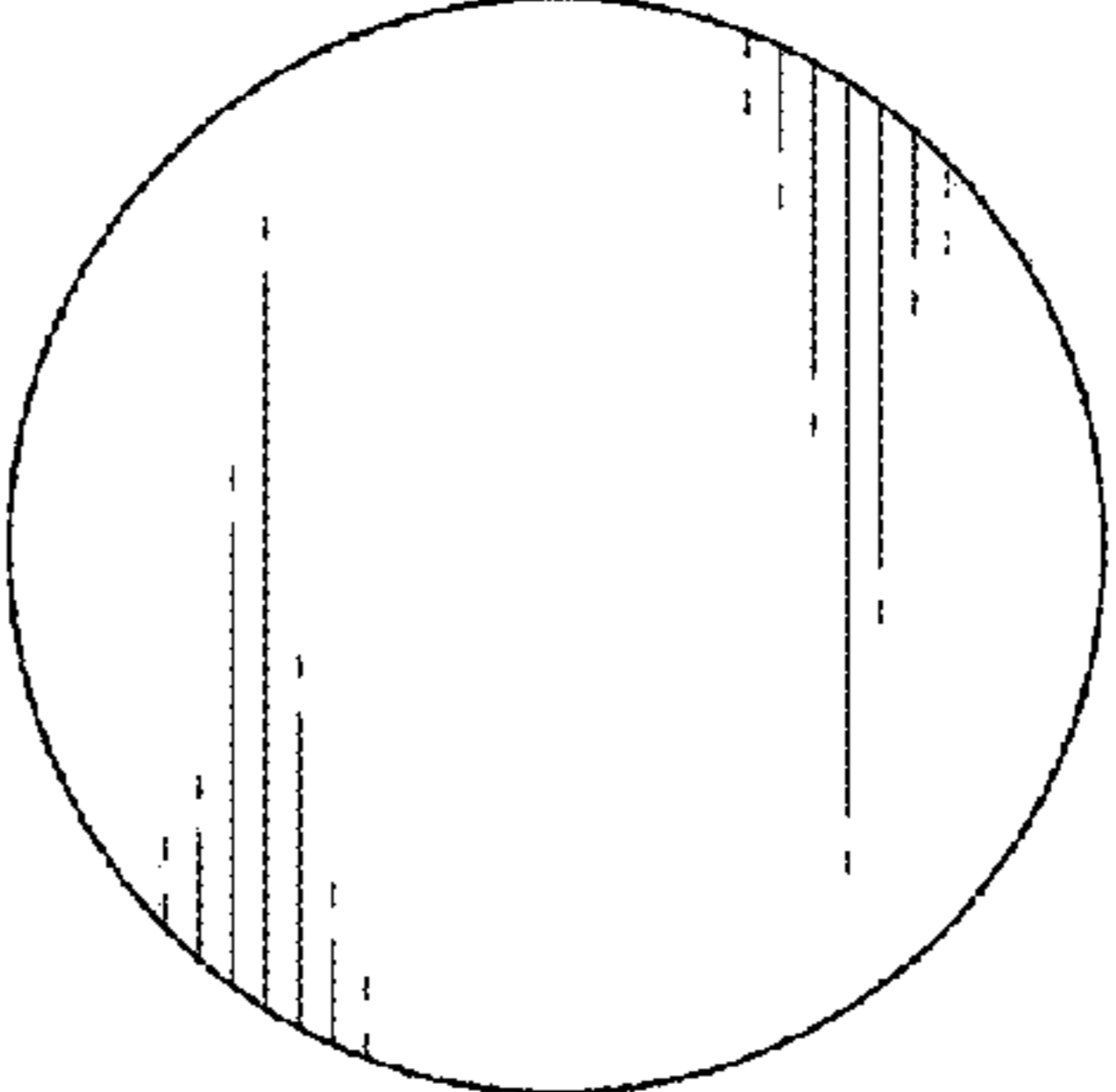

FIG. 7