



US00D766097S

(12) **United States Design Patent** (10) **Patent No.:** **US D766,097 S**
Lee (45) **Date of Patent:** **** Sep. 13, 2016**

(54) **PUMPING VESSEL FOR PACKING
COSMETIC PRODUCTS**

(71) Applicant: **YONWOO CO., LTD.**, Incheon (KR)

(72) Inventor: **Jae Ock Lee**, Incheon (KR)

(73) Assignee: **YONWOO CO., LTD.**, Incheon (KR)

(**) Term: **14 Years**

(21) Appl. No.: **29/520,415**

(22) Filed: **Mar. 13, 2015**

(51) **LOC (10) Cl.** **09-01**

(52) **U.S. Cl.**

USPC **D9/690**; D9/692

(58) **Field of Classification Search**

USPC D9/682-694, 516, 529, 434-436, 445,
D9/447-450, 454; D28/76, 77, 88, 89,
D28/91.1

CPC B65D 83/14; B65D 83/16; B65D 83/20;
B65D 83/205; B65D 83/206; B65D 83/22;
B65D 83/222; B65D 83/28; B65D 83/38;
B65D 83/384; B65D 83/386; B65D 83/388;
B65D 83/226; B65D 83/285; B65D 83/30;
B65D 83/303; B65D 83/306; B65D 83/40;
B05B 11/00; B05B 11/0027; B05B 11/0035;
B05B 11/0037; B05B 11/0054; B05B
11/3001; B05B 11/3004; B05B 1/3042;
B05B 11/3052; B05B 11/3059; B05B 11/306;
A45D 34/00; A45D 34/02; A45D 34/04;
A45D 34/041; A45D 2034/005; A45D
2034/007

See application file for complete search history.

(56) **References Cited**

U.S. PATENT DOCUMENTS

D406,761 S * 3/1999 Garcia D9/434
D455,960 S * 4/2002 Dobbs D9/448
D521,386 S * 5/2006 Priestman D28/76
D563,221 S * 3/2008 Ashiwa D24/115
D565,953 S * 4/2008 Swint D9/504

D578,894 S * 10/2008 Seum D9/504
D628,086 S * 11/2010 Tanner D28/4
D665,267 S * 8/2012 Dittmer D9/688
D708,961 S * 7/2014 Jung D9/723
D713,097 S * 9/2014 Goswell D28/7
D715,156 S * 10/2014 Park D9/688
8,915,400 B2 * 12/2014 Muller B05B 11/3001
222/113
D723,934 S * 3/2015 Kim D9/691
D727,168 S * 4/2015 Raghupati D9/688
2011/0309083 A1 * 12/2011 Hsiu-Tzu
Charlene A45D 34/00
220/505
2015/0071801 A1 * 3/2015 De Regt B05B 11/0016
417/472

FOREIGN PATENT DOCUMENTS

KR 300398005.0000 * 11/2005
KR 300533516.0000 * 7/2009
KR 300569205.0000 * 8/2010

(Continued)

Primary Examiner — Catherine Tuttle

(74) *Attorney, Agent, or Firm* — Marshall, Gerstein & Borun LLP

(57) **CLAIM**

The applicant claims the ornamental design for a pumping vessel for packing cosmetic products, as shown and described.

DESCRIPTION

FIG. 1 is a perspective view of a pumping vessel for packing cosmetic products showing my new design; FIG. 2 is a front elevational view thereof; FIG. 3 is a rear elevational view thereof; FIG. 4 is a left side elevational view thereof, a right side elevational view is a mirror image of the left side elevational view; FIG. 5 is a top plan view thereof; and, FIG. 6 is a bottom plan view thereof.

The broke lines depicted in FIG. 6 are included for the purpose of illustrating the interior features that form no part of the claimed design.

1 Claim, 6 Drawing Sheets

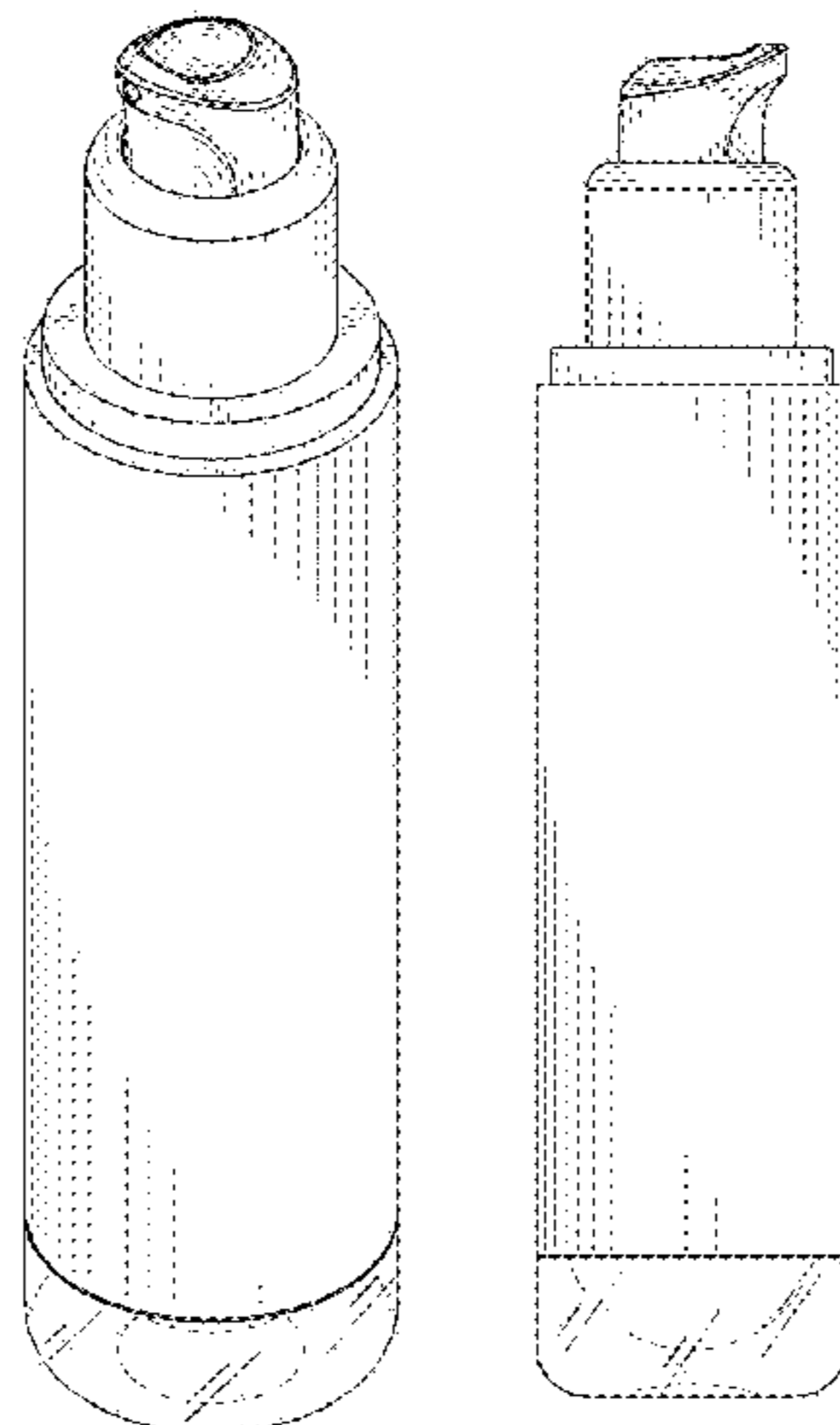

US D766,097 S

Page 2

(56)

References Cited

KR	300684618.0000	*	3/2013
KR	300733019.0000	*	3/2014
KR	300757463.0000	*	8/2014

FOREIGN PATENT DOCUMENTS

KR 300668140.0000 * 11/2012

* cited by examiner

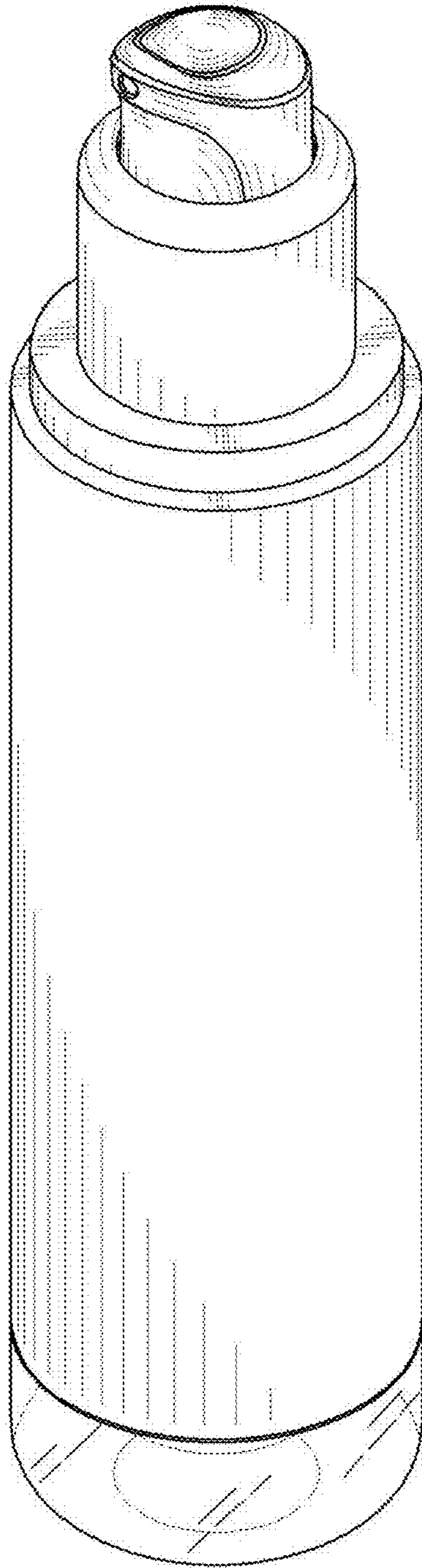

Fig. 1

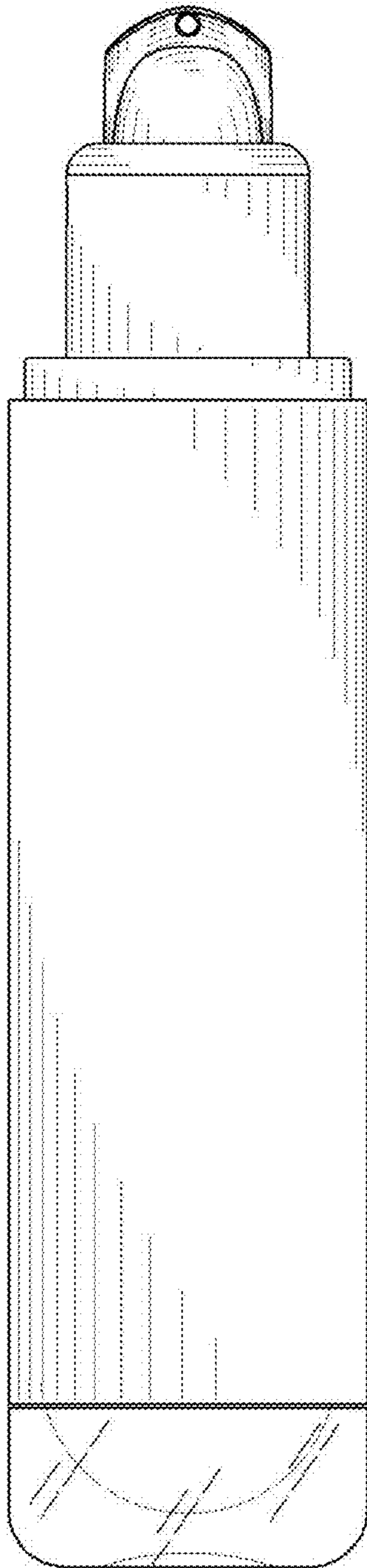

Fig. 2

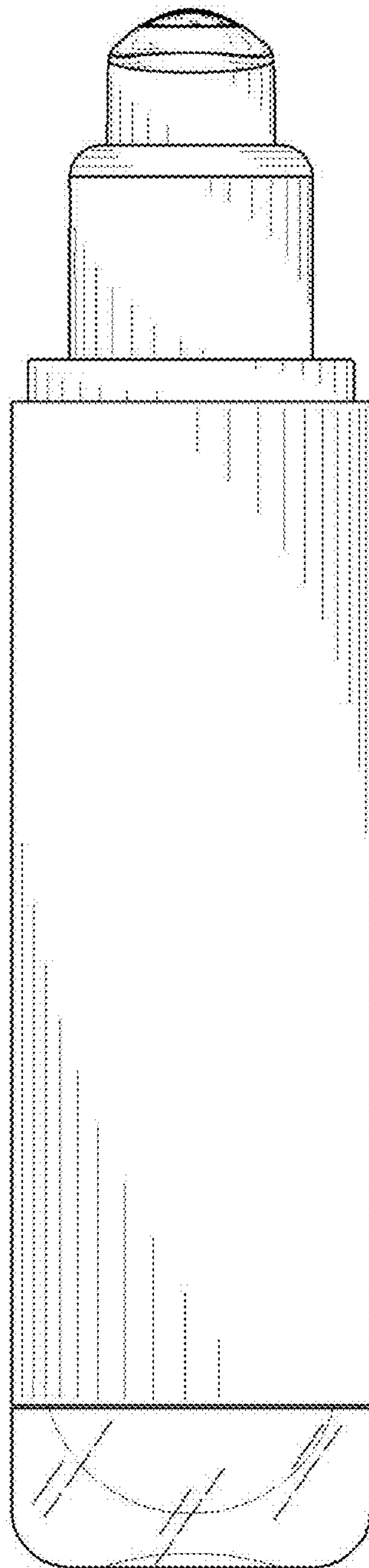

Fig. 3

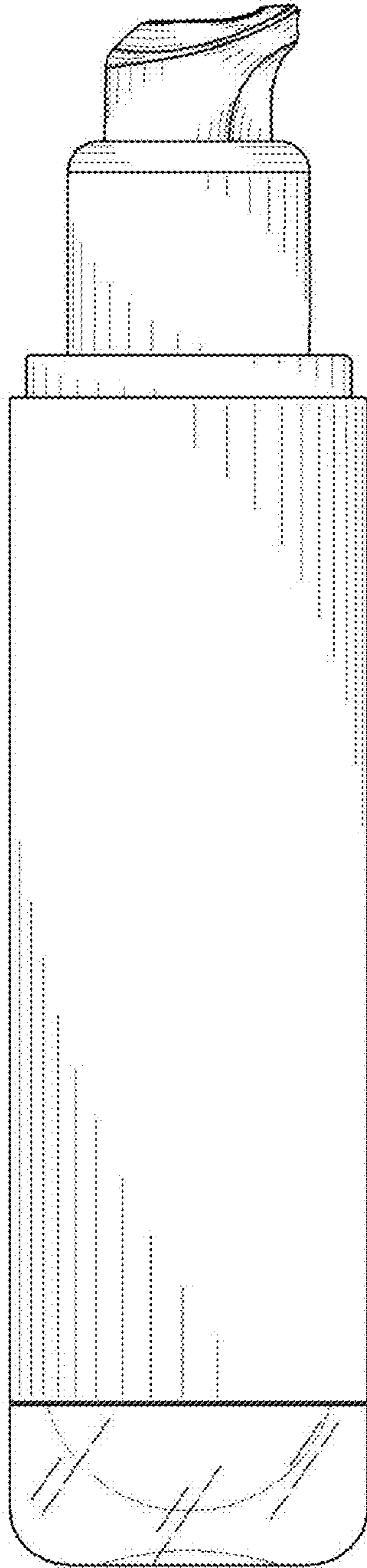

Fig. 4

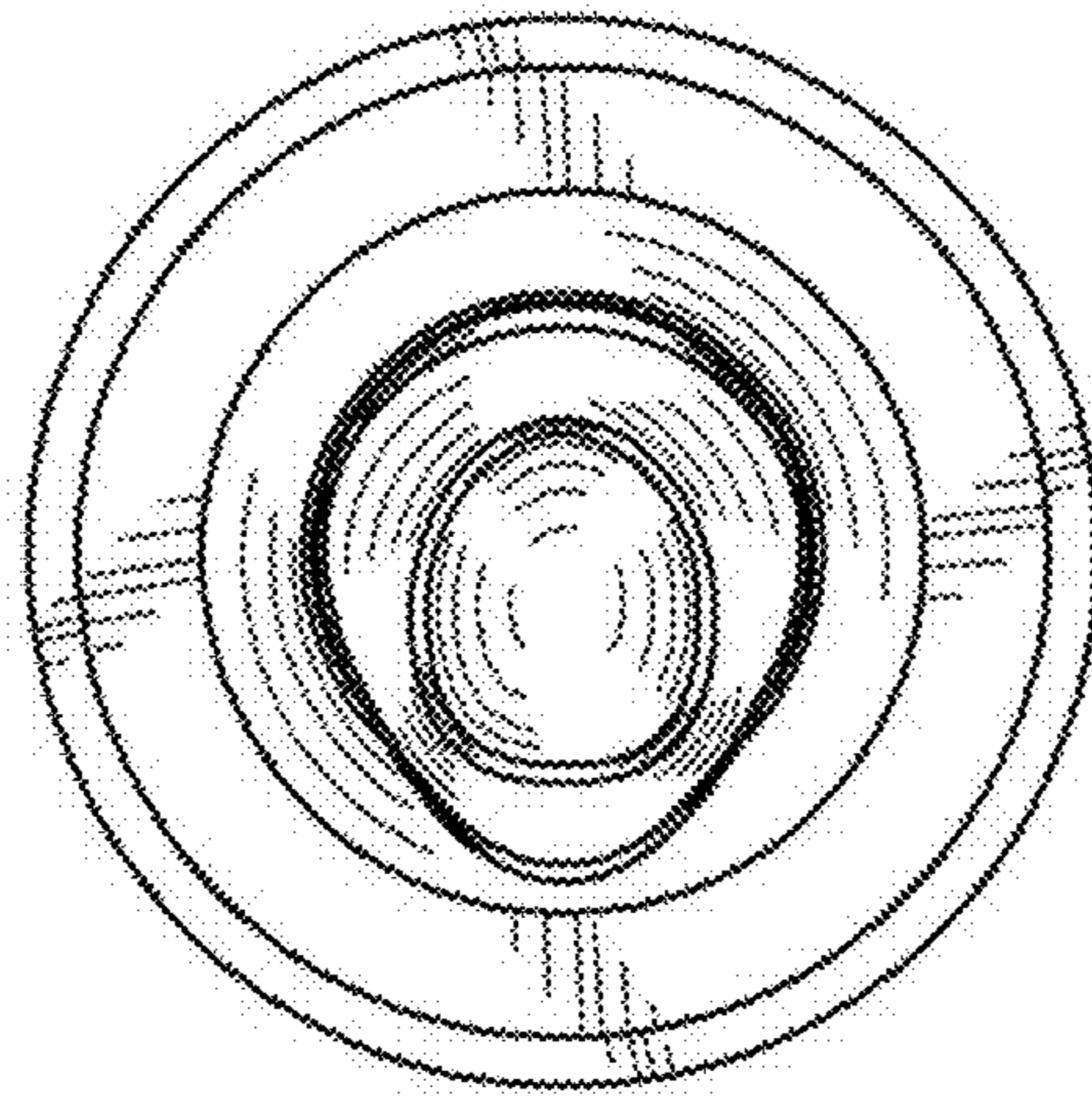

Fig. 5

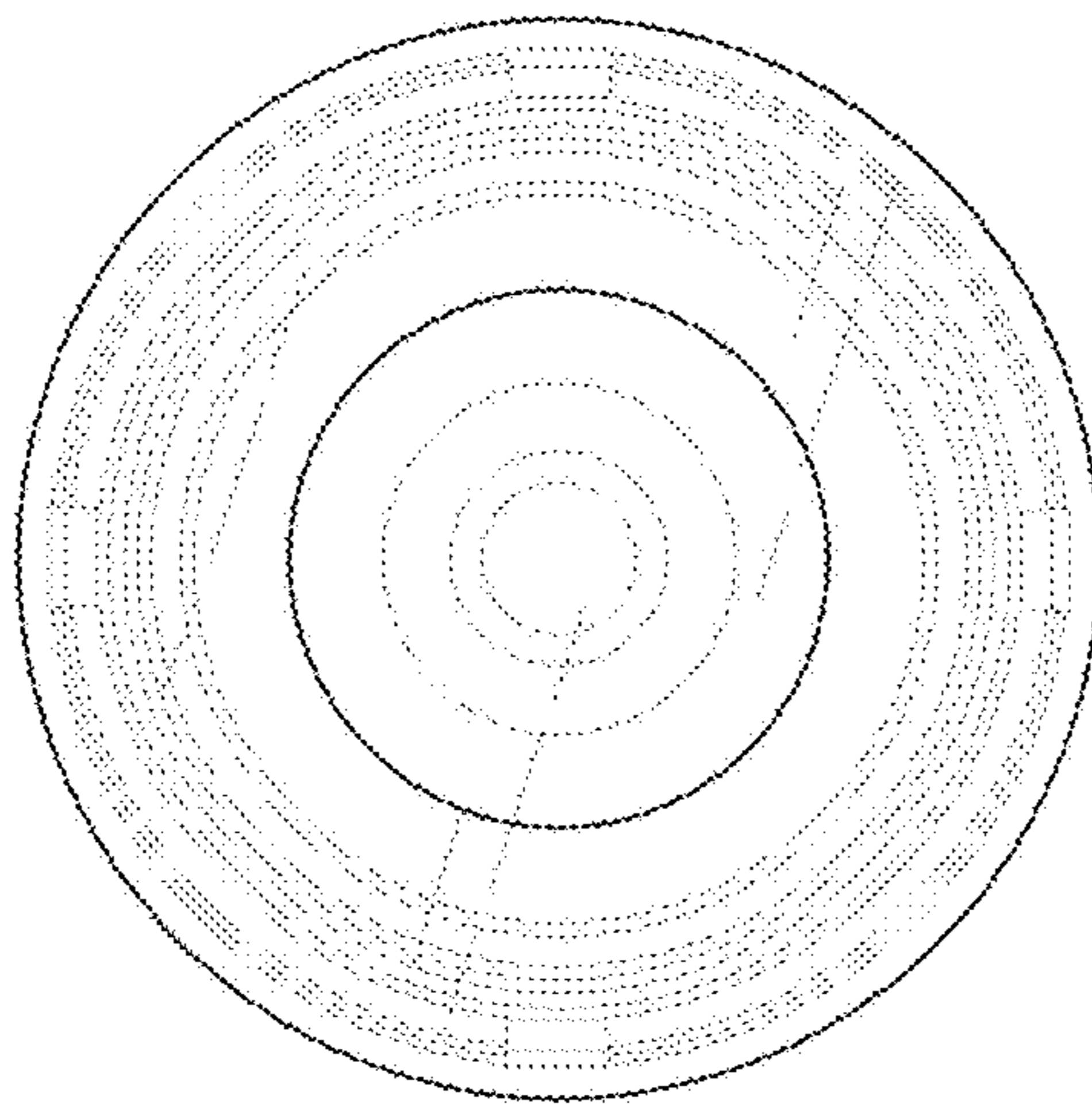

Fig. 6