



US00D766048S

(12) **United States Design Patent** (10) **Patent No.:** **US D766,048 S**
Liu et al. (45) **Date of Patent:** **** Sep. 13, 2016**

- (54) **KNIFE BLOCK**
- (71) Applicant: **Calphalon Corporation**, Atlanta, GA (US)
- (72) Inventors: **Andrew Q. Liu**, Alpharetta, GA (US);
Steven J. Muske, Marietta, GA (US);
Neil John Varlamoff, Acworth, GA (US)
- (73) Assignee: **Calphalon Corporation**, Atlanta, GA (US)
- (**) Term: **14 Years**
- (21) Appl. No.: **29/515,510**
- (22) Filed: **Jan. 23, 2015**
- (51) **LOC (10) Cl.** **07-99**
- (52) **U.S. Cl.**
USPC **D7/637**
- (58) **Field of Classification Search**
USPC D7/631, 637-641; D19/65, 75, 81-85;
76/82, 84, 86; 211/13.1, 60.1, 70, 70.6,
211/70.7; 248/37.3, 37.6; 451/552
CPC A47F 5/16; A47F 7/00; A47G 21/00;
A47G 21/14; B26B 3/00; B26B 27/00
See application file for complete search history.

- D478,787 S * 8/2003 Logiudice D7/637
- D483,624 S * 12/2003 Bradshaw D7/638
- 7,322,113 B2 * 1/2008 Tetreault A47G 21/14
211/70.7
- D572,982 S 7/2008 de Bretton Gordon
- 7,631,772 B2 12/2009 Lafleur
- 7,637,803 B2 12/2009 Welch
- D657,635 S 4/2012 De Bretton Gordon
- 2004/0031159 A1 * 2/2004 Rosenberg A47G 21/14
30/298.4
- 2004/0148787 A1 * 8/2004 Rosenberg A47G 21/14
30/298.4

(Continued)

FOREIGN PATENT DOCUMENTS

- KR 20110006563 * 6/2011 A47G 21/14

OTHER PUBLICATIONS

KitchenAid, "16-Piece Triple Riveted Cutlery Set with Natural Block with Built-In Sharpener," on or before Jan. 23, 2015, 1 page.

(Continued)

Primary Examiner — Derrick Holland
Assistant Examiner — Janice Lim

(57) **CLAIM**

The ornamental design for a knife block, as shown and described.

DESCRIPTION

FIG. 1 is a front perspective view of a knife block, showing our new design;
FIG. 2 is a right view thereof;
FIG. 3 is a left view thereof;
FIG. 4 is a top plan view thereof;
FIG. 5 is a bottom plan view thereof;
FIG. 6 is a front view thereof; and,
FIG. 7 is a back view thereof.

The broken line portions are included to show unclaimed subject matter only and form no part of the claimed design.

1 Claim, 7 Drawing Sheets

(56) **References Cited**

U.S. PATENT DOCUMENTS

- D247,735 S * 4/1978 Gangelhoff D7/637
- D267,142 S 12/1982 Pollard
- D271,171 S * 11/1983 Kinkade D7/637
- D300,497 S 4/1989 Ward
- D358,173 S 5/1995 Stoudt
- D382,774 S * 8/1997 Cohen D7/637
- D421,879 S * 3/2000 Miller D7/637
- D434,615 S 12/2000 Chien
- D440,124 S * 4/2001 Weng D7/637
- 6,394,627 B1 * 5/2002 Lo A47G 21/14
362/127
- D471,072 S * 3/2003 Gordner D7/637

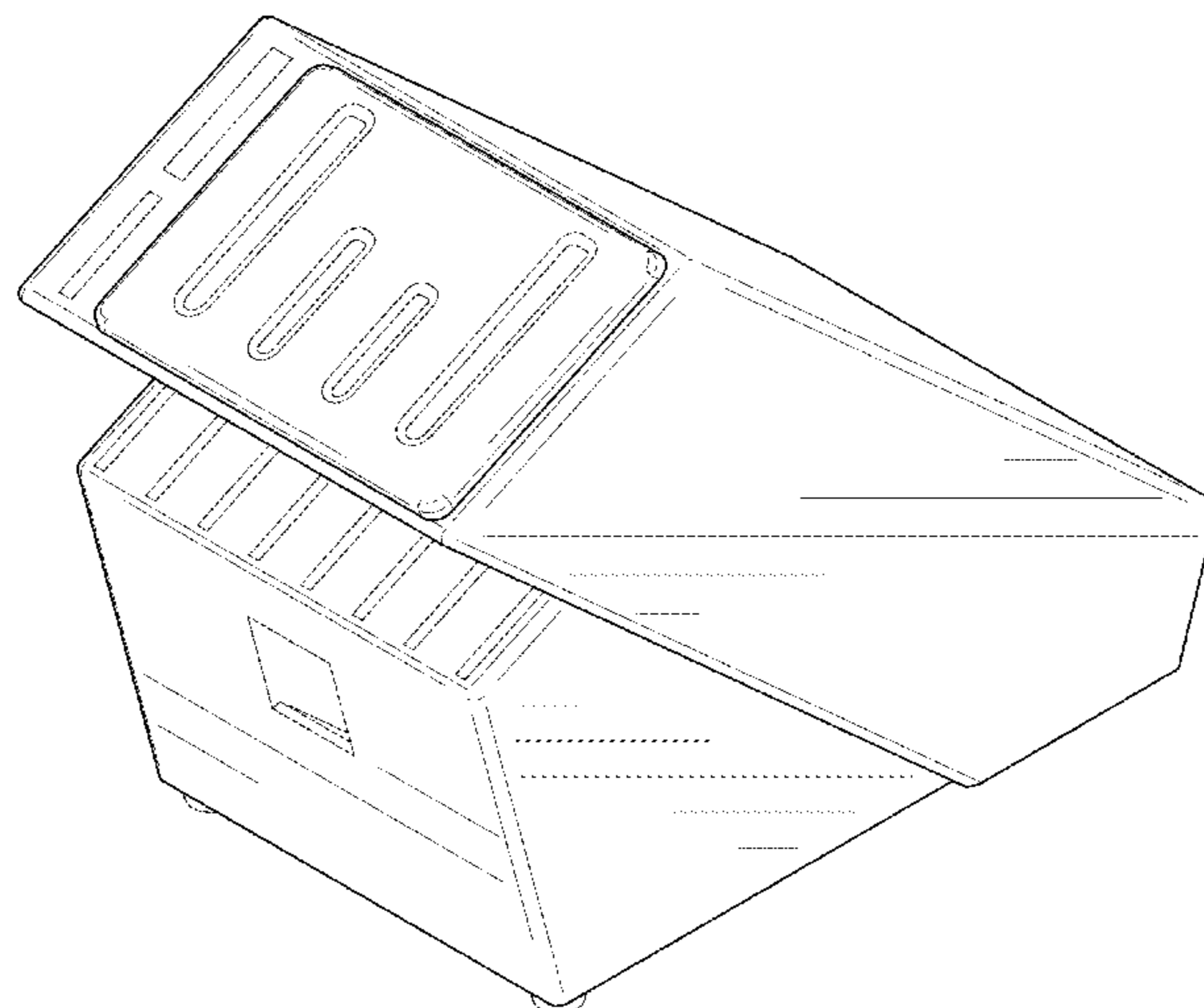

(56)

References Cited

U.S. PATENT DOCUMENTS

2006/0117575 A1* 6/2006 Tetreault A47G 21/14
30/298.4
2008/0173772 A1 7/2008 Welch
2009/0149120 A1 6/2009 Welch
2012/0266468 A1 10/2012 Murphy

OTHER PUBLICATIONS

Chicago Cutlery, "18-Piece Insignia Steel Knife Set with Block and In-Block Sharpener," on or before Jan. 23, 2015, 1 page.
Design U.S. Appl. No. 29/515,507, filed Jan. 23, 2015, entitled "Knife Block," Inventor: Liu et al.
Design U.S. Appl. No. 29/515,509, filed Jan. 23, 2015, entitled "Knife Block," Inventor: Liu et al.

Design U.S. Appl. No. 29/515,511, filed Jan. 23, 2015, entitled "Knife Block," Inventor: Liu et al.
Design U.S. Appl. No. 29/515,512, filed Jan. 23, 2015, entitled "Knife Block," Inventor: Liu et al.
Design U.S. Appl. No. 29/515,513, filed Jan. 23, 2015, entitled "Knife Block," Inventor: Liu et al.
Design U.S. Appl. No. 29/515,516, filed Jan. 23, 2015, entitled "Knife Block," Inventor: Gossens et al.
Chicago Cutlery Metropolitan 15-Piece Block Knife Set, announced May 2008, [online], site visited Apr. 11, 2016. Available from Internet, <URL: <http://www.amazon.com>>, 5 pages.
Wusthof Classic Ikon 5 Piece Knife Block Set, announced Apr. 2012, [online], site visited Apr. 11, 2016. Available from Internet, <URL: <http://www.amazon.com>>, 7 pages.

* cited by examiner

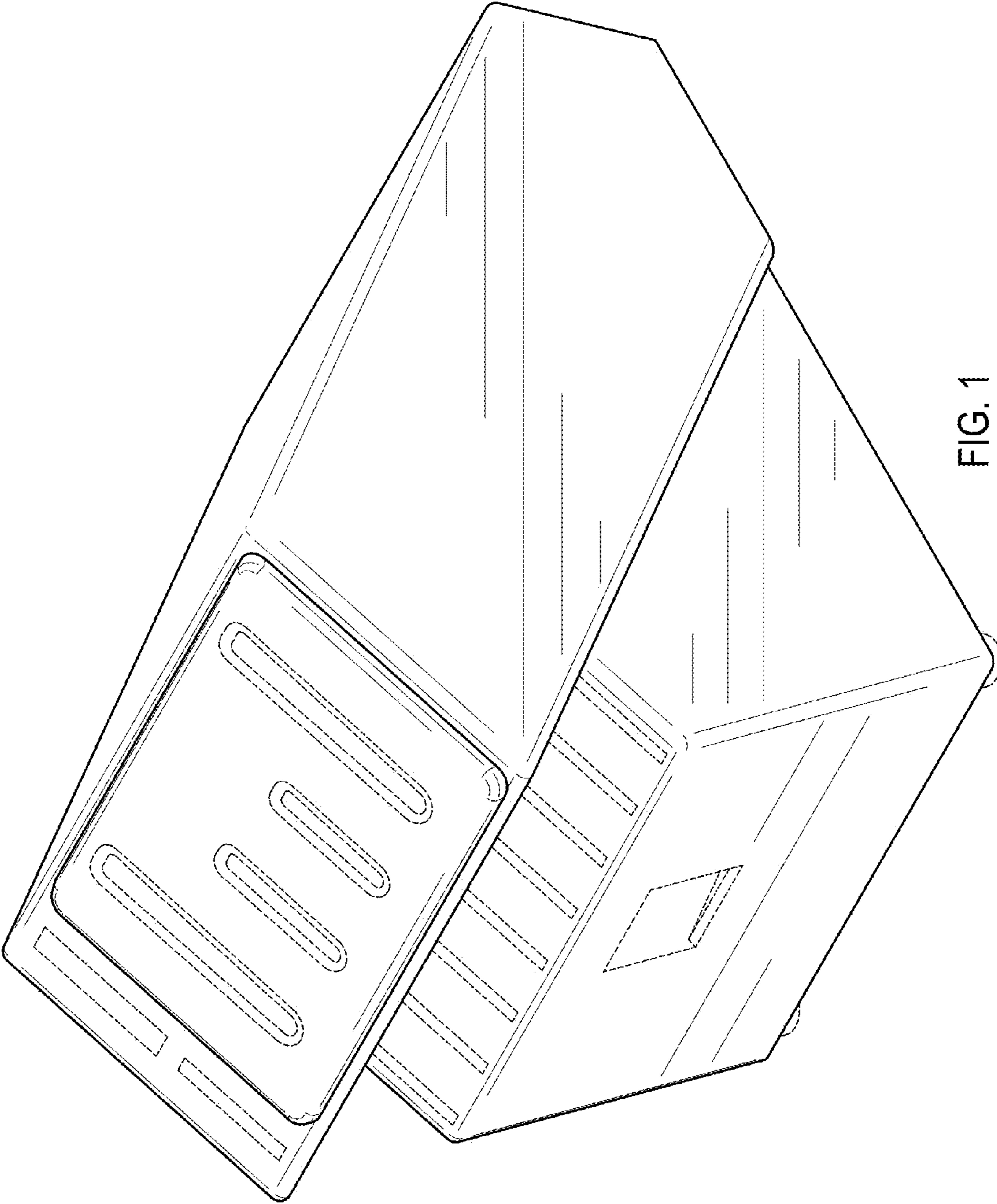

FIG. 1

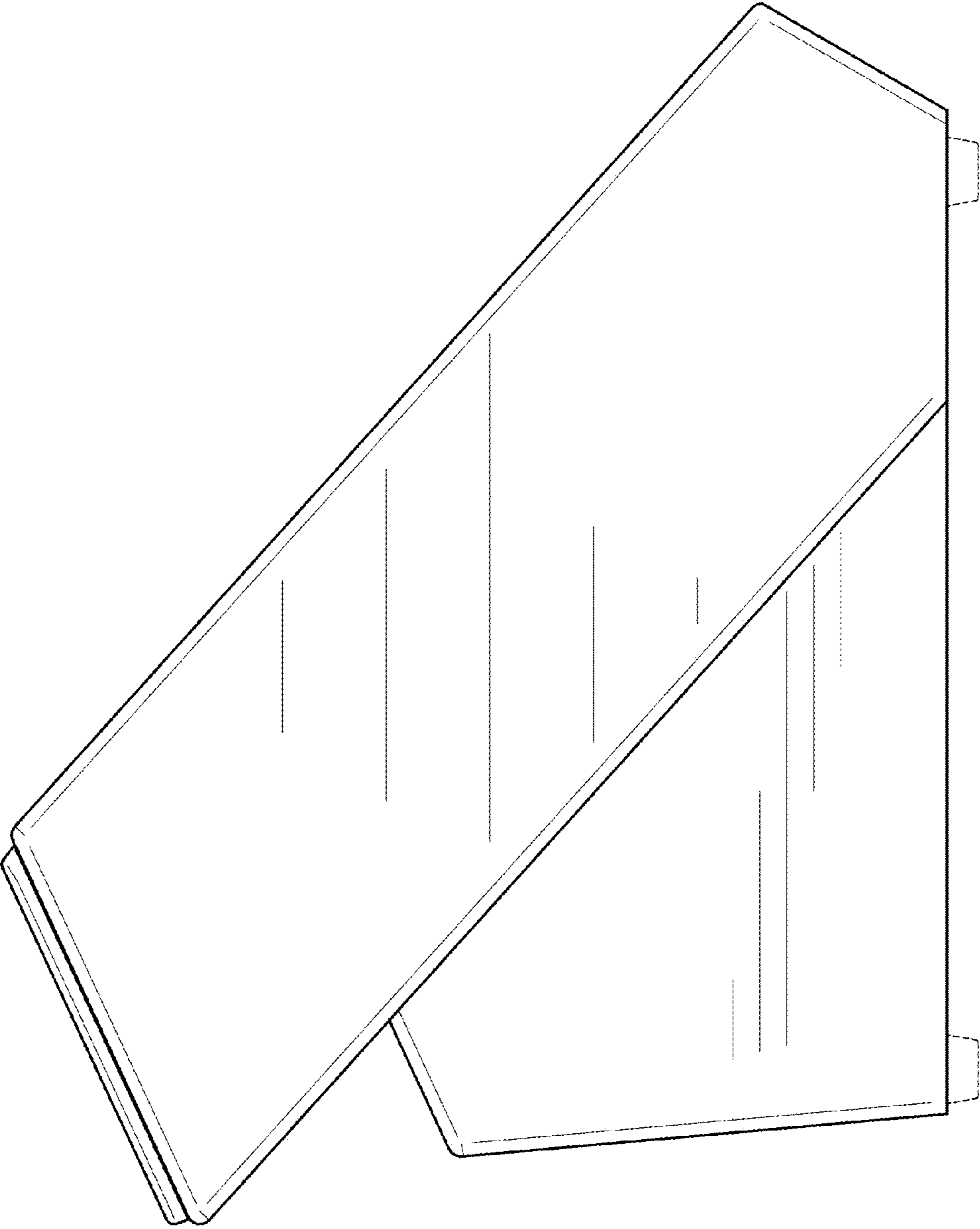

FIG.2

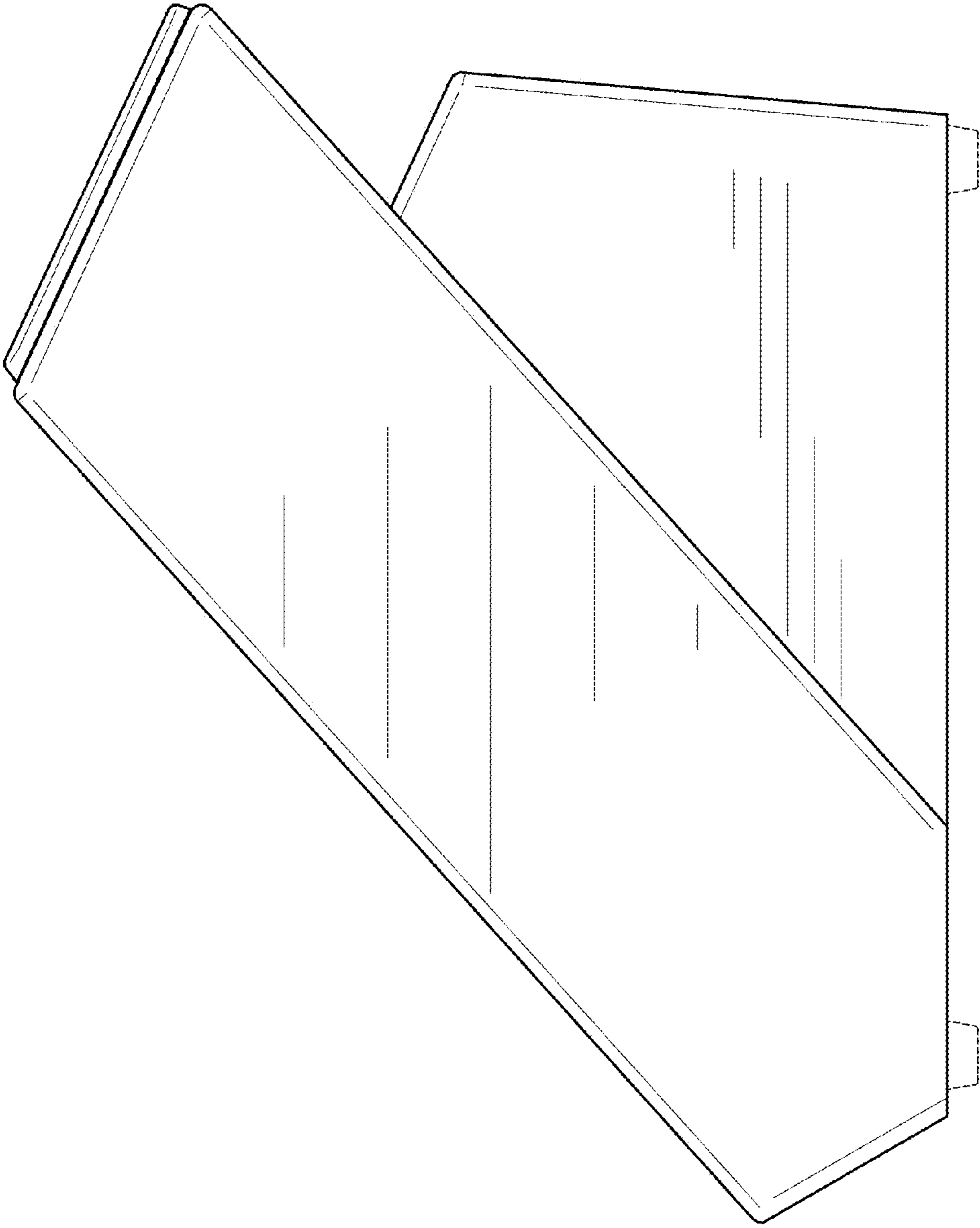

FIG. 3

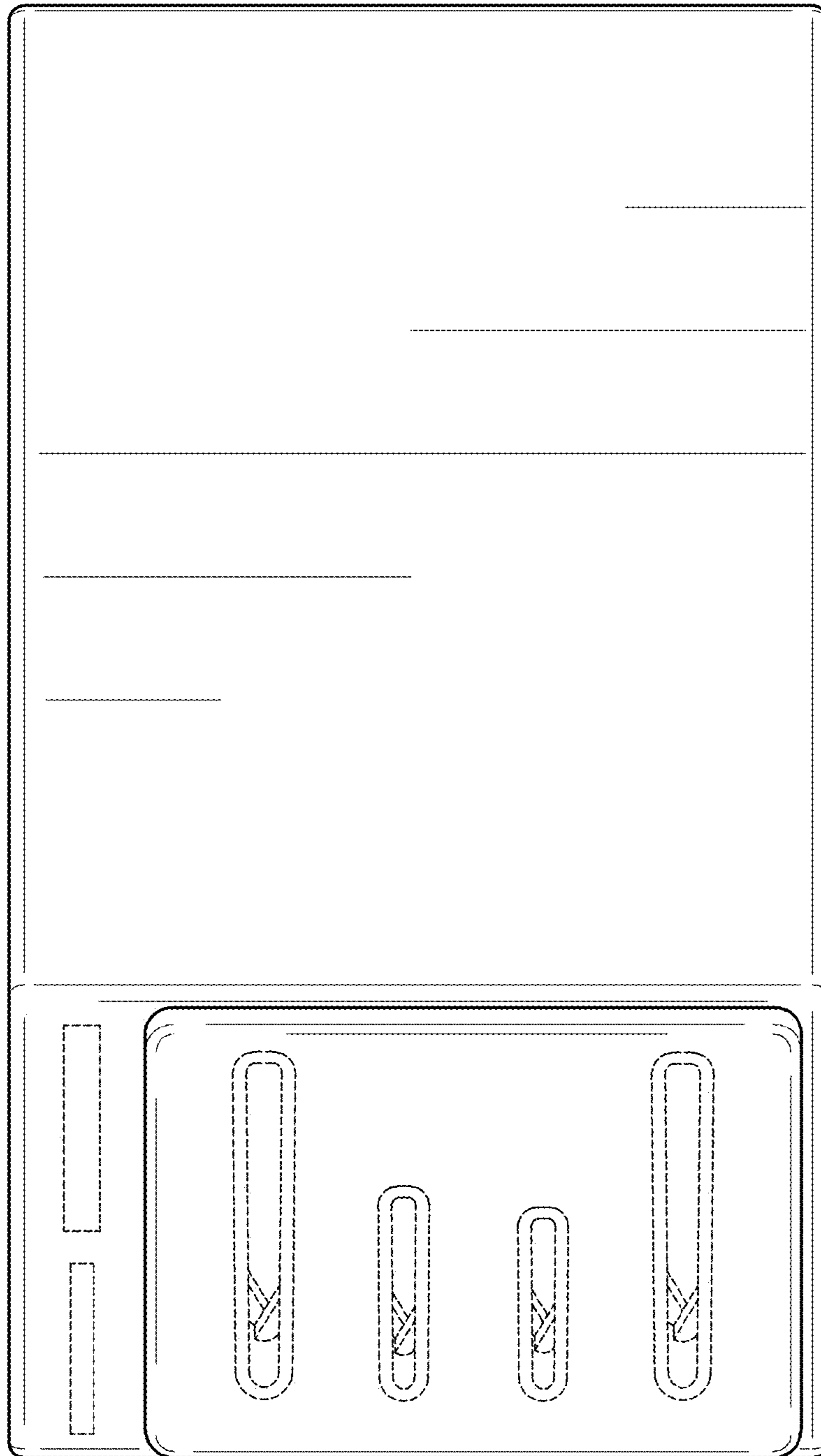

FIG. 4

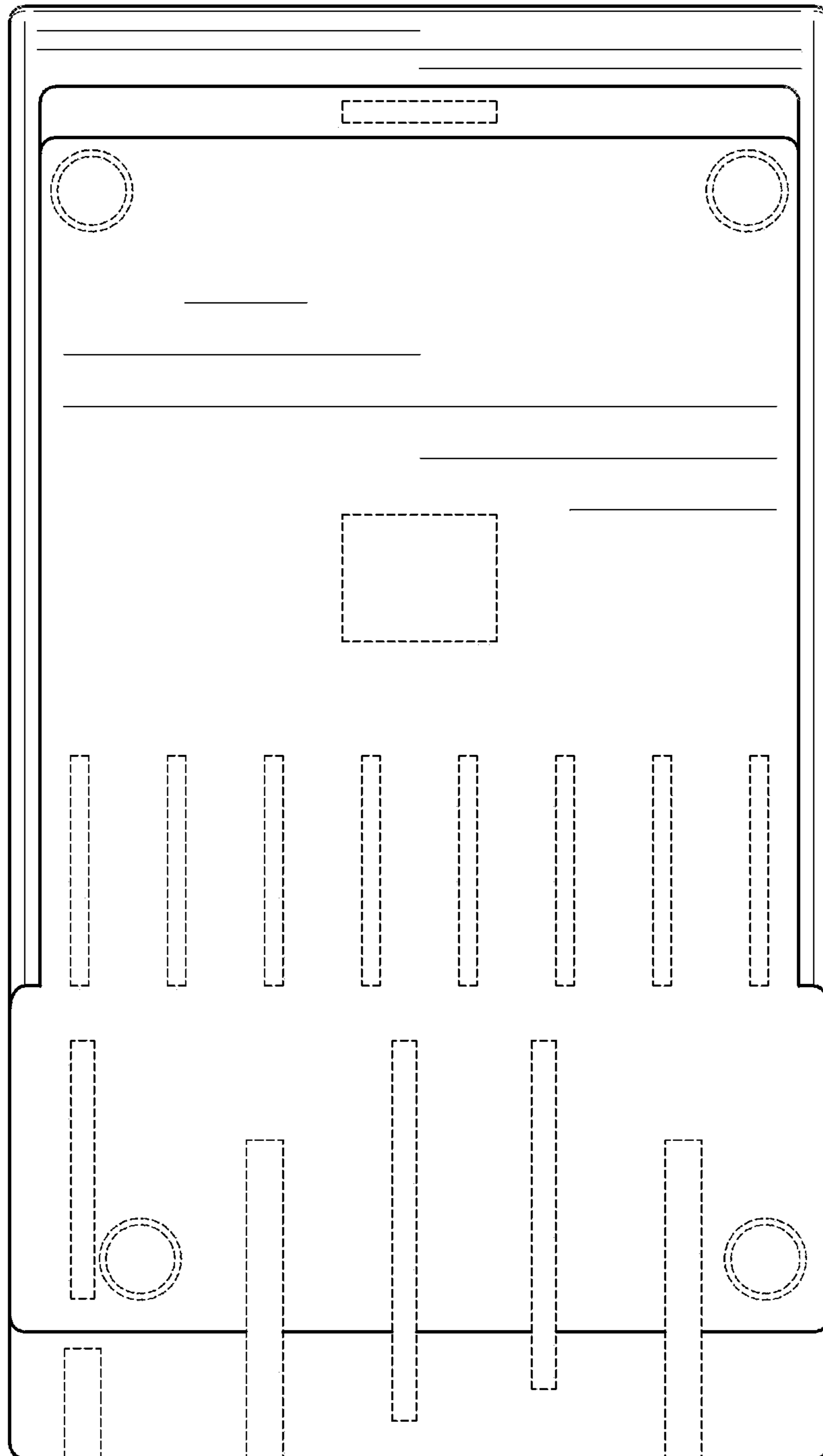

FIG. 5

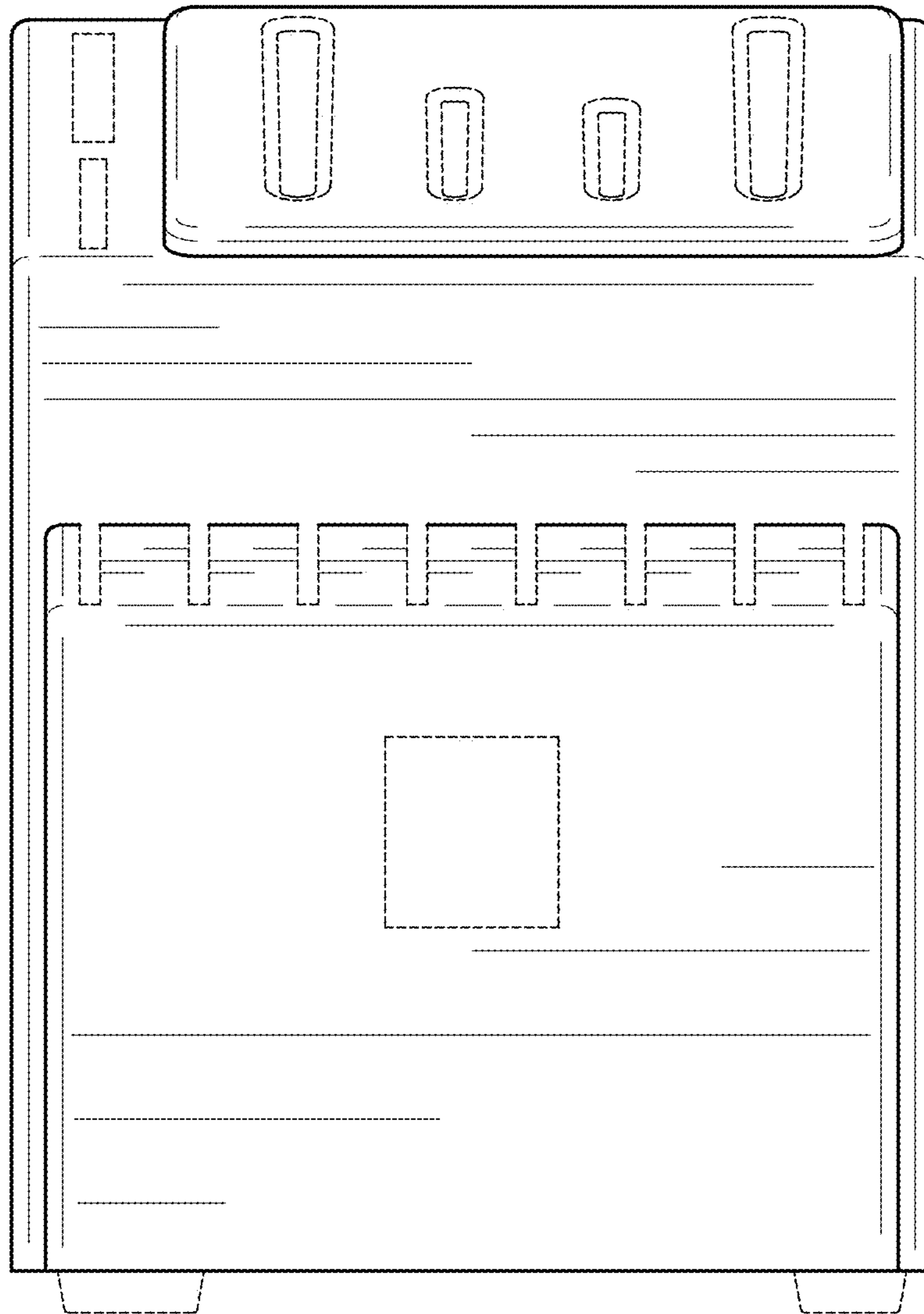

FIG. 6

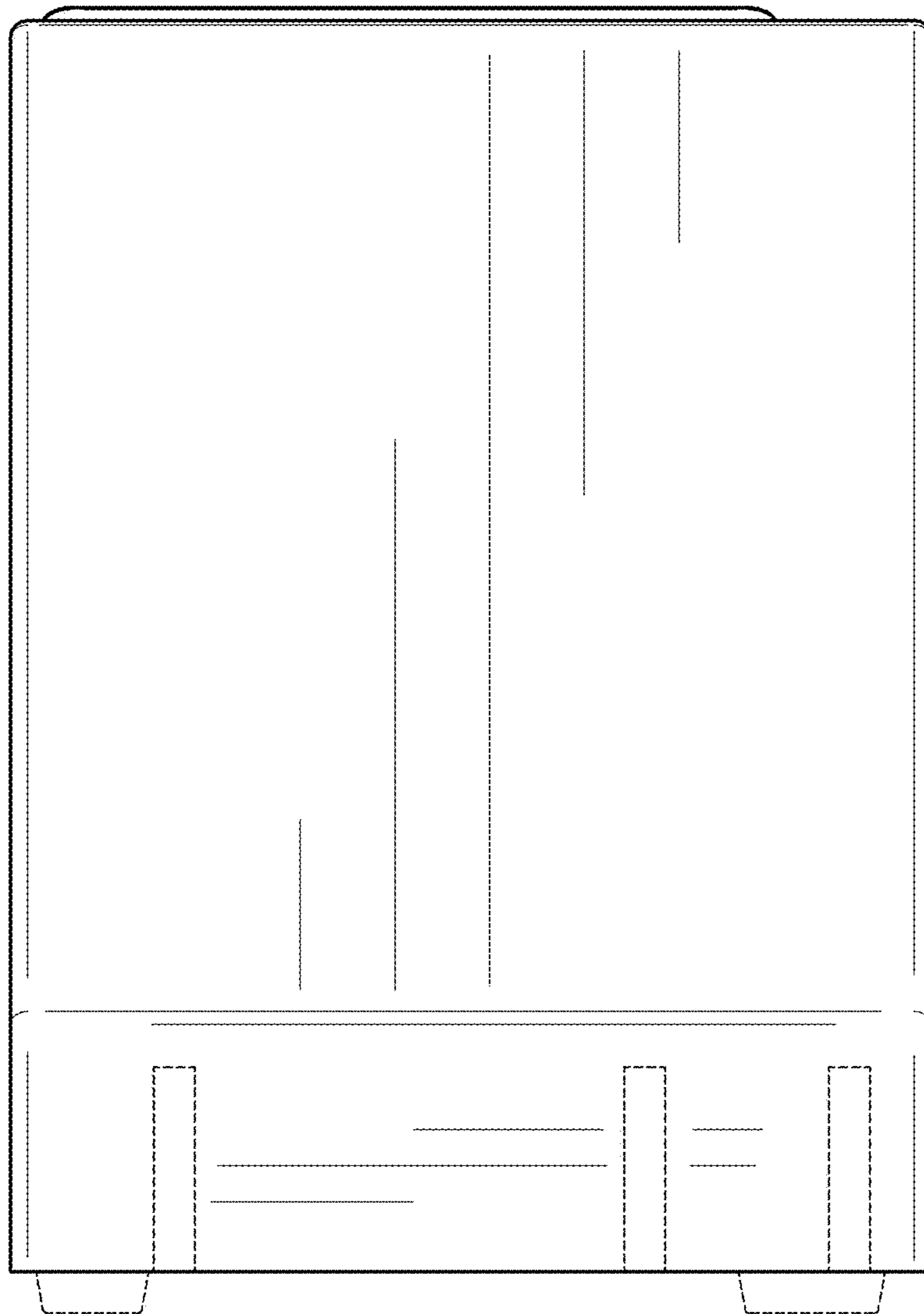

FIG. 7