



US00D765972S

(12) **United States Design Patent** (10) **Patent No.:** **US D765,972 S**  
**Daniel et al.** (45) **Date of Patent:** **\*\* Sep. 13, 2016**

(54) **COMBINED SUITCASE AND TRACKING APPARATUS**  
(71) Applicants: **Isaac S. Daniel**, Miramar, FL (US); **Basel Saleh**, Miramar, FL (US)  
(72) Inventors: **Isaac S. Daniel**, Miramar, FL (US); **Basel Saleh**, Miramar, FL (US)  
(\*\*) Term: **14 Years**  
(21) Appl. No.: **29/516,909**  
(22) Filed: **Feb. 6, 2015**  
(51) **LOC (10) Cl.** ..... **03-01**  
(52) **U.S. Cl.**  
USPC ..... **D3/274; D3/279; D3/294**  
(58) **Field of Classification Search**  
USPC ..... D3/273, 274, 276, 279, 281, 282, 289, D3/294, 301, 902, 900, 905; D34/24, 25  
CPC .... A45C 5/00; A45C 5/03; A45C 2005/037; A45C 5/14; A45C 7/0027; A45C 7/0018; A45C 7/0045  
See application file for complete search history.

D714,057 S \* 9/2014 Hou ..... D3/279  
D728,236 S \* 5/2015 Virassamy ..... D3/264  
D730,050 S \* 5/2015 Hogan ..... D3/279  
D743,168 S \* 11/2015 Niu ..... D3/279  
2014/0284157 A1 \* 9/2014 Sheikh ..... A45C 7/0027  
190/103  
2016/0029763 A1 \* 2/2016 Meersschaert ..... A45C 5/02  
190/18 A

**OTHER PUBLICATIONS**

amazon.com, "Bluesmart Smart Carry-On Luggage", Accessed Mar. 25, 2016, (<http://www.amazon.com/Bluesmart-Carry-On-Suitcase-Connects-Smartphone/dp/B00X5OUC1U>).\*

\* cited by examiner

*Primary Examiner* — Jennifer Rivard  
*Assistant Examiner* — April Rivas  
(74) *Attorney, Agent, or Firm* — Carol N. Green Kaul, Esq.

(57) **CLAIM**  
The ornamental design for a combined suitcase and tracking apparatus, as shown and described.

**DESCRIPTION**

FIG. 1 is a front perspective view of the invention.  
FIG. 2 is a rear perspective view of the invention.  
FIG. 3 is a top plan view of the invention.  
FIG. 4 is a bottom plan view of the invention.  
FIG. 5 is a right side view of the invention.  
FIG. 6 is a left side view of the invention.  
FIG. 7 is a front elevational view of the invention; and,  
FIG. 8 is a rear elevational view of the invention.

**1 Claim, 7 Drawing Sheets**

(56) **References Cited**  
U.S. PATENT DOCUMENTS  
D428,698 S \* 8/2000 Cheng ..... D3/276  
D438,005 S \* 2/2001 Tiramani ..... D3/273  
D462,169 S \* 9/2002 Giovanni ..... D3/279  
D525,031 S \* 7/2006 Miles ..... D3/279  
D666,414 S \* 9/2012 Giovannoni ..... D3/279  
D677,050 S \* 3/2013 Saba ..... D3/276  
D712,658 S \* 9/2014 Lai ..... D3/279

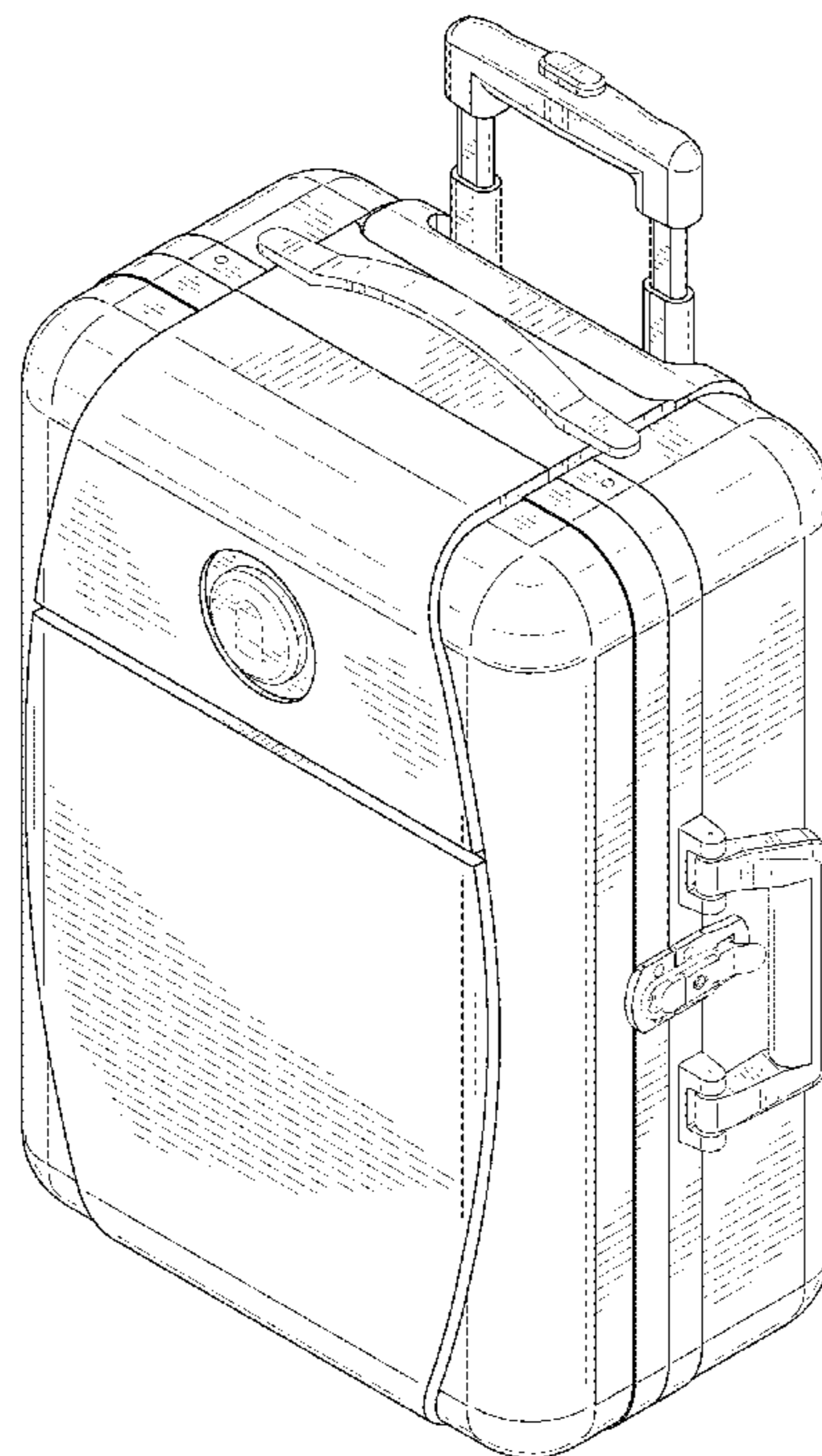

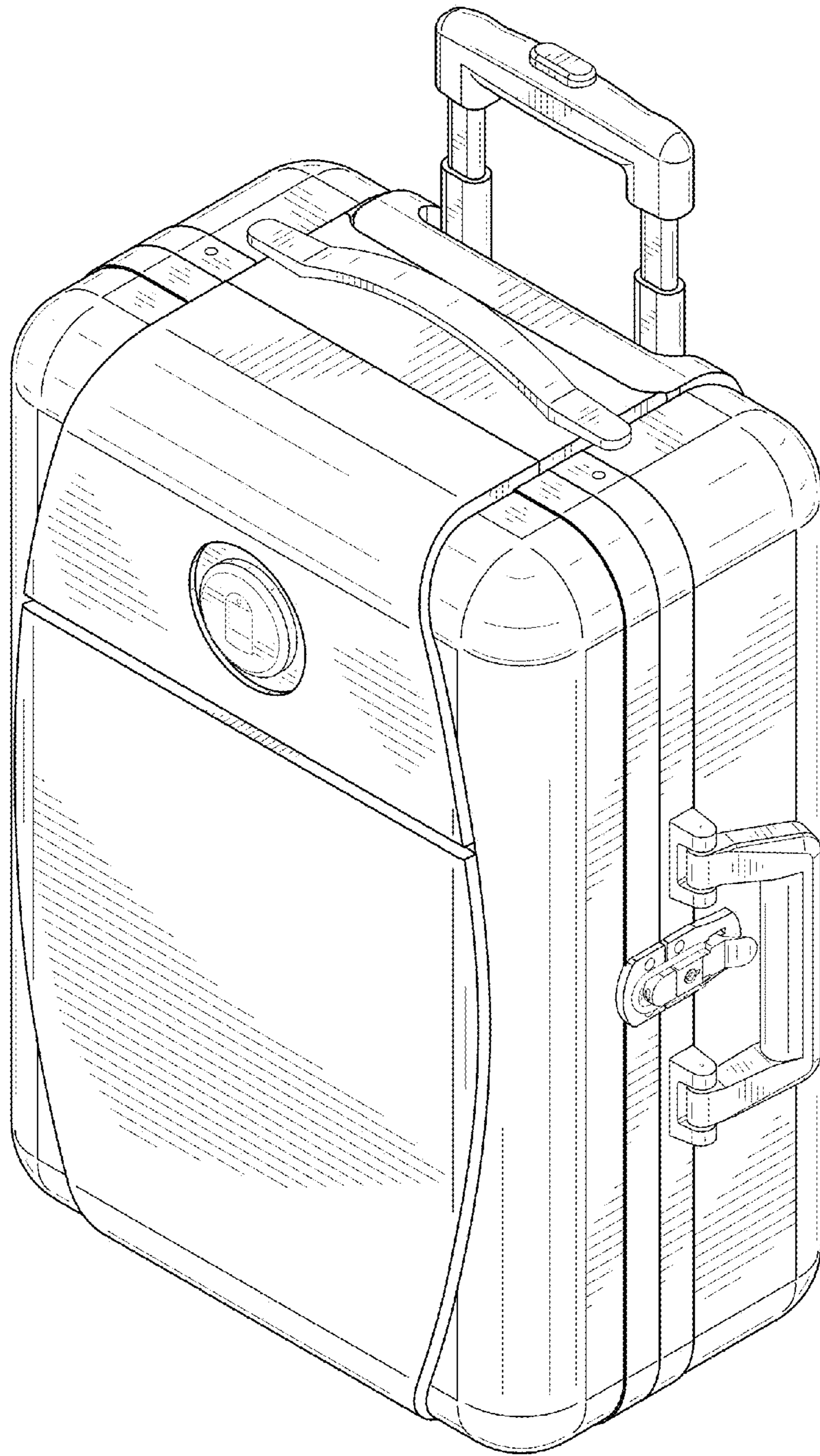

FIG. 1

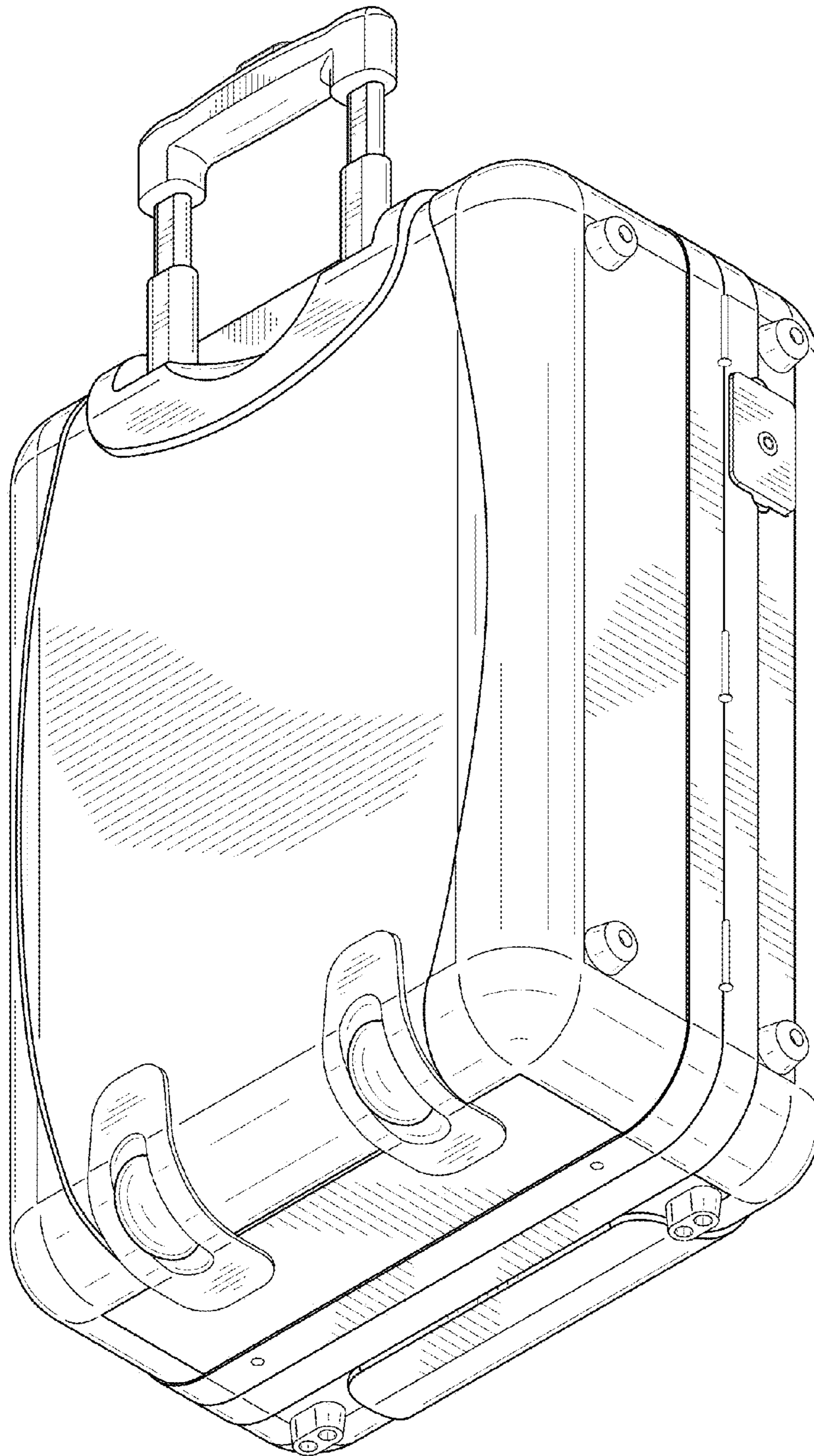

FIG. 2

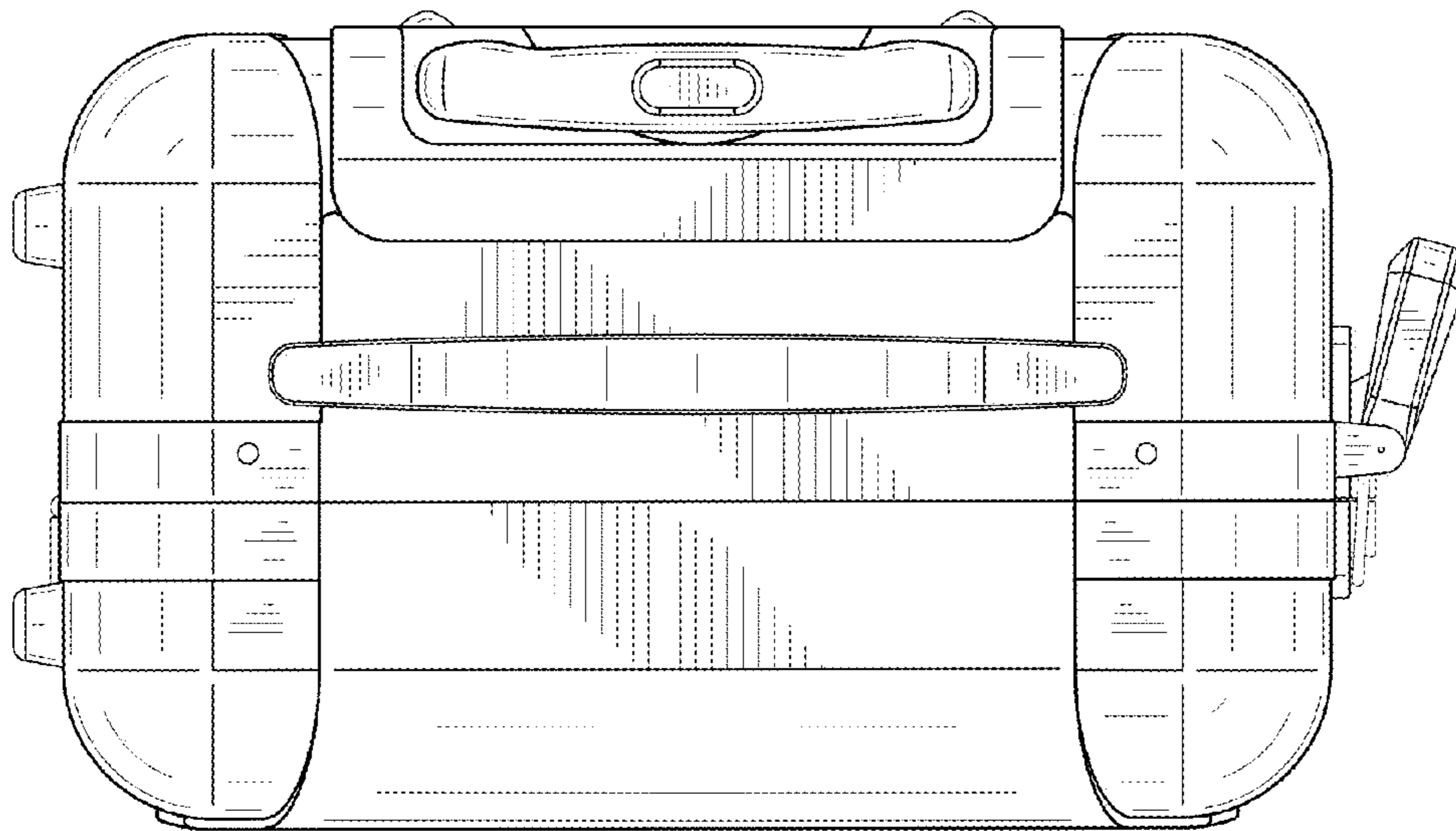

FIG. 3

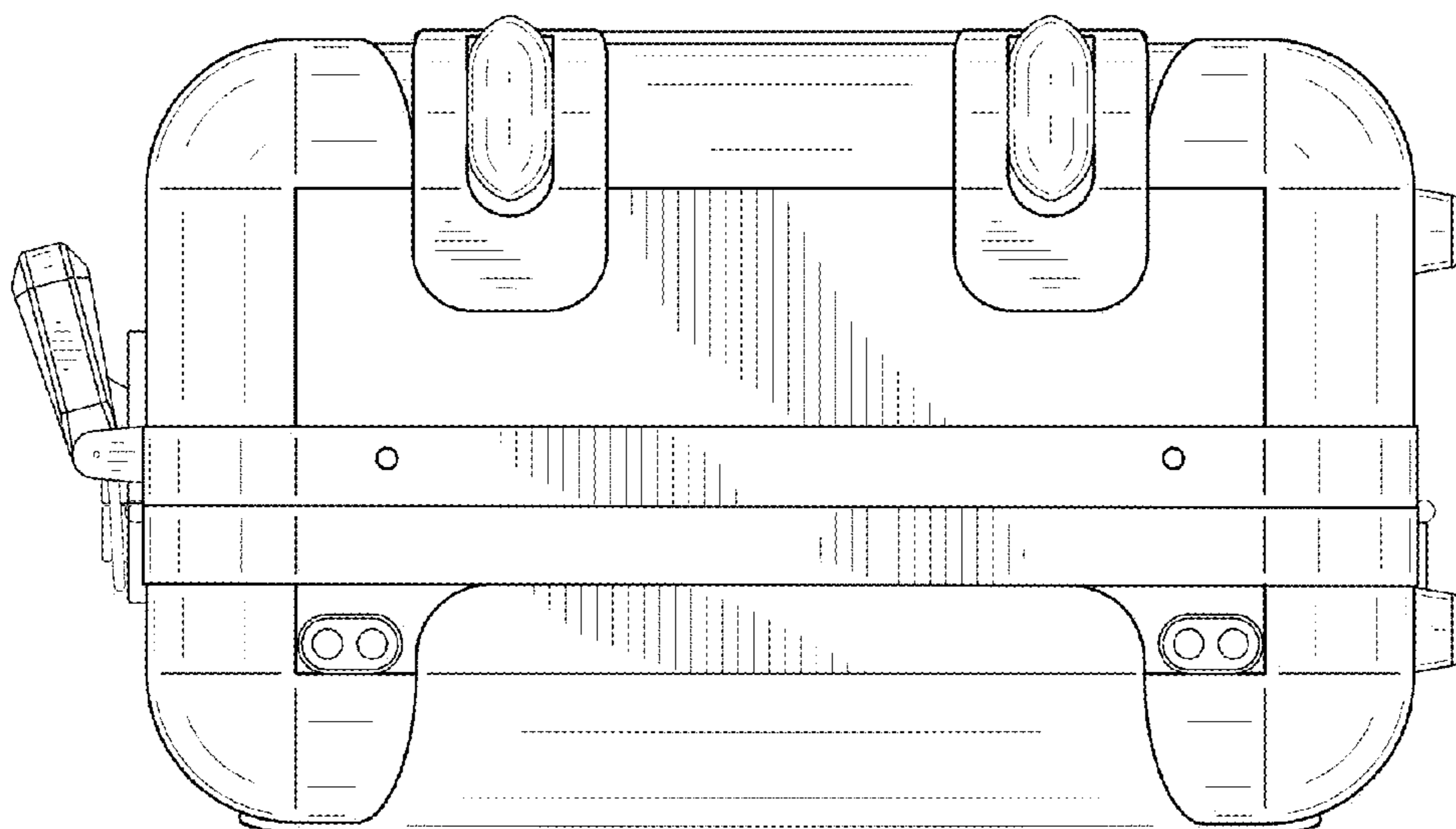

FIG. 4

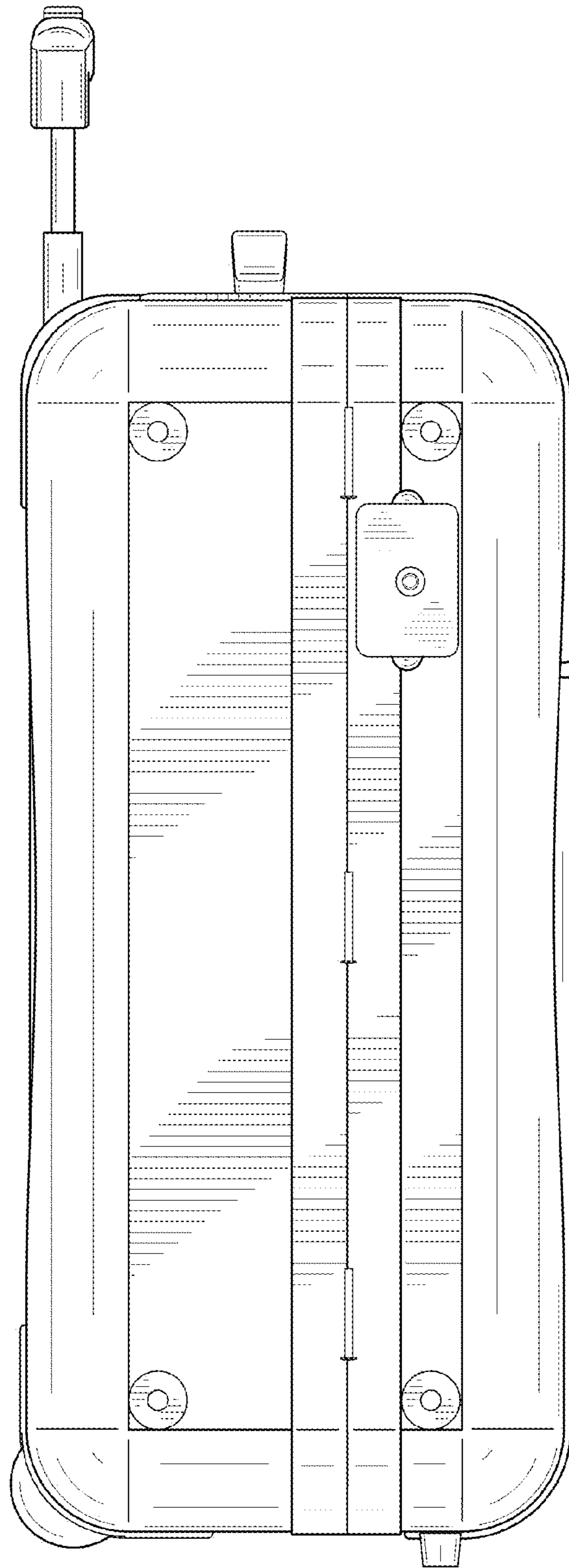

FIG. 5

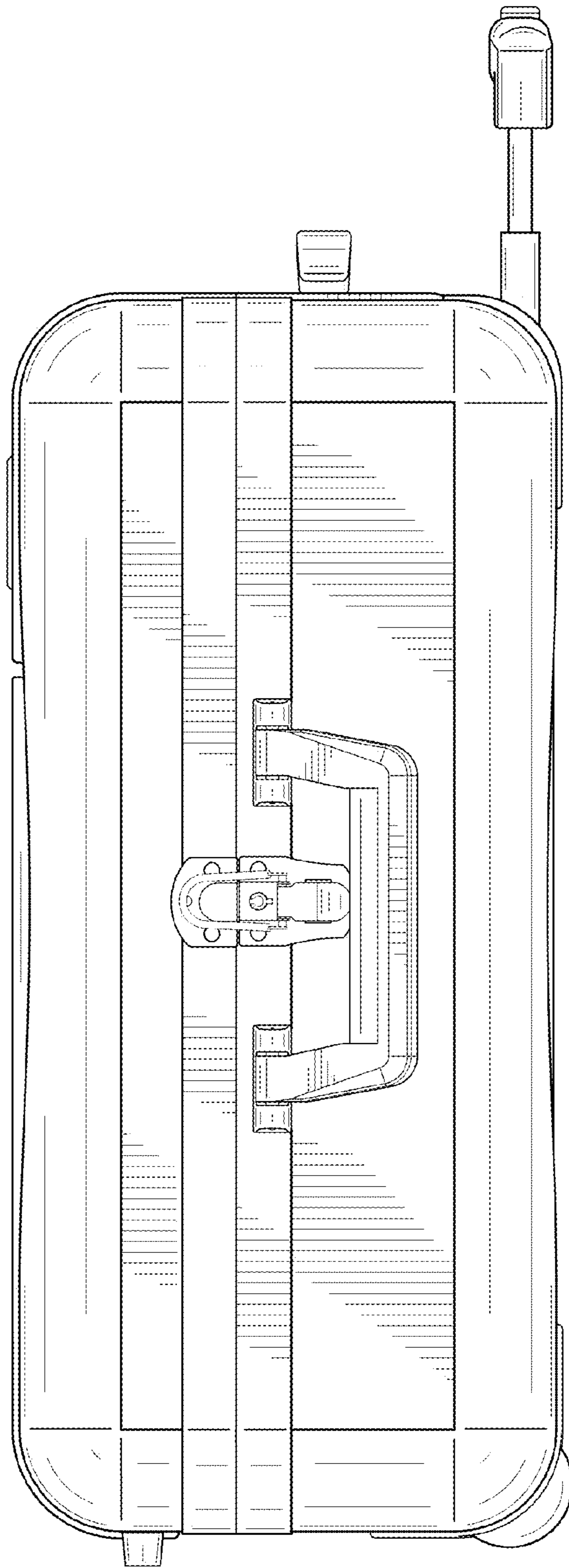

FIG. 6

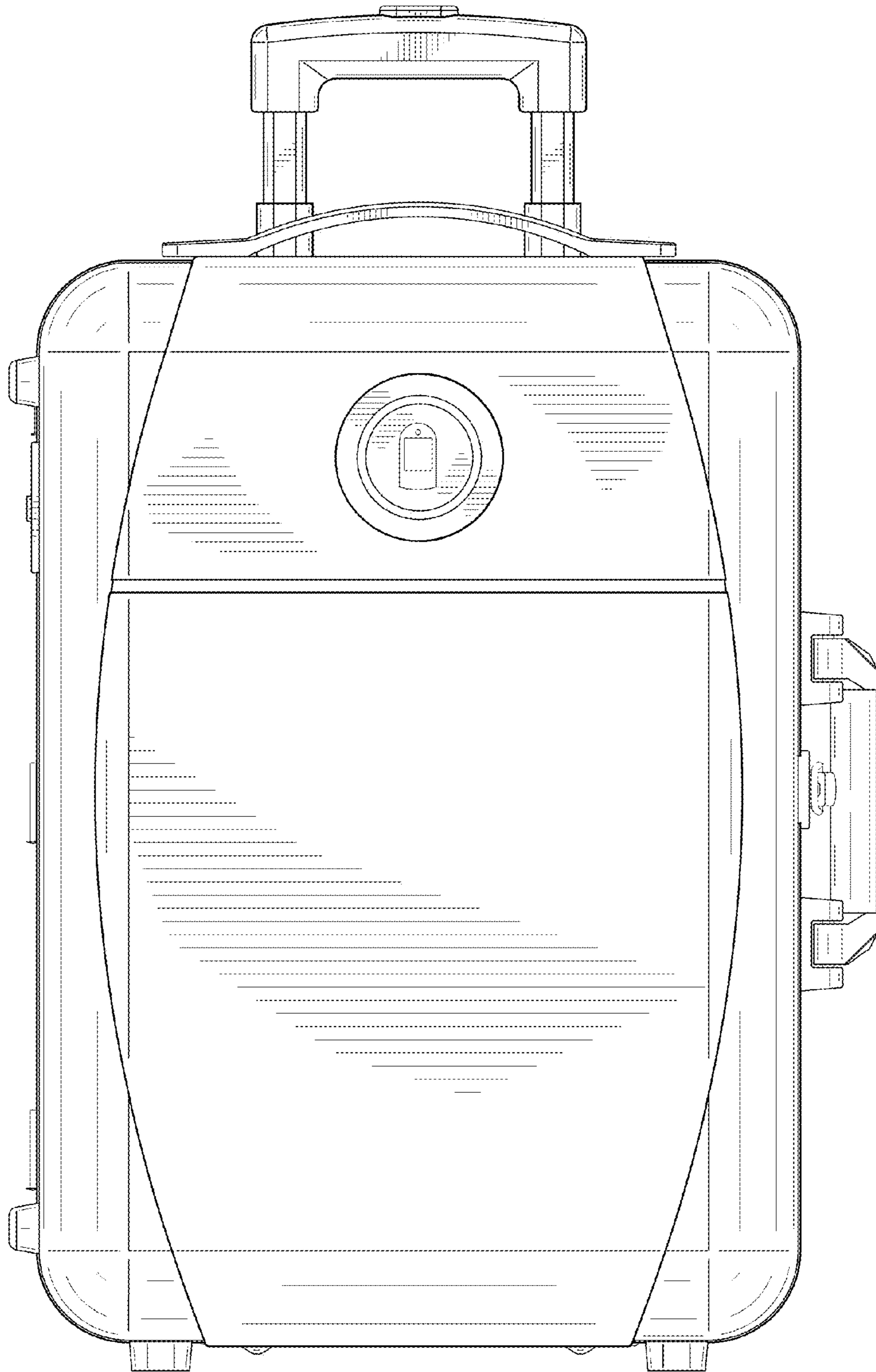

FIG. 7

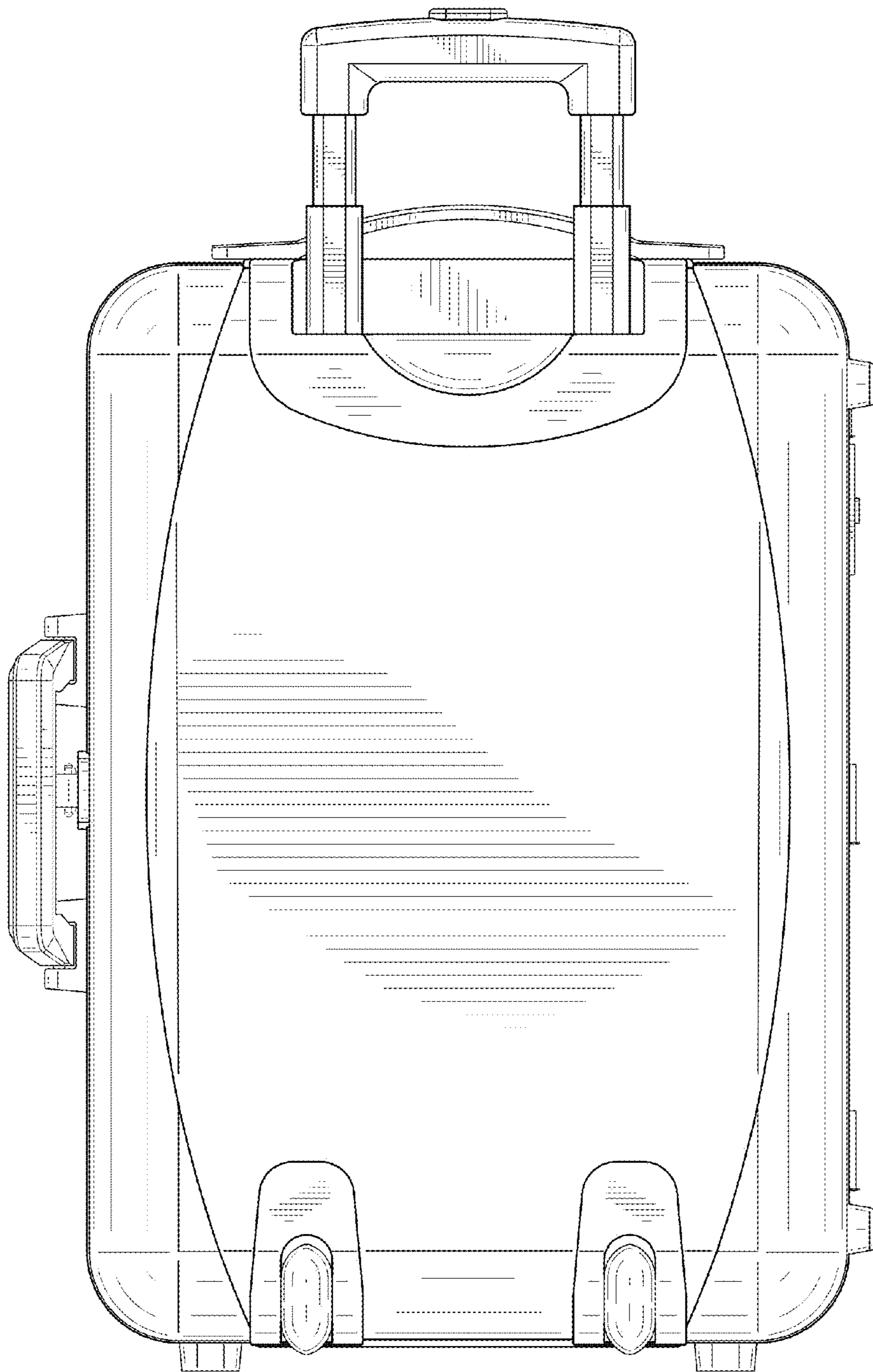

FIG. 8