



US00D765949S

(12) **United States Design Patent** (10) **Patent No.:** **US D765,949 S**
Svensrud et al. (45) **Date of Patent:** **** Sep. 13, 2016**

(54) **SLEEPING BAG**

- (71) Applicant: **Target Brands, Inc.**, Minneapolis, MN (US)
- (72) Inventors: **Christopher Erik Svensrud**, Minneapolis, MN (US); **Janell Kaley Hibbard**, Rosemount, MN (US)
- (73) Assignee: **Target Brands, Inc.**, Minneapolis, MN (US)

(**) Term: **14 Years**

(21) Appl. No.: **29/517,418**

(22) Filed: **Feb. 12, 2015**

(51) **LOC (10) Cl.** **02-01**

(52) **U.S. Cl.**
USPC **D2/719**

(58) **Field of Classification Search**
 USPC D2/719, 718, 700, 728, 823, 824, 825,
 D2/830, 831; D6/603, 605, 595
 CPC A41D 15/04; A41D 3/00; A41B 13/06;
 A41B 13/065
 See application file for complete search history.

(56) **References Cited**

U.S. PATENT DOCUMENTS

5,815,833	A	10/1998	Kuo	
D446,907	S *	8/2001	Hall	D2/719
D541,011	S *	4/2007	Day	D2/831
D557,880	S *	12/2007	O'Connor-Cowley	D2/719
D624,279	S	9/2010	Adams et al.	
D641,136	S *	7/2011	Abrams	D2/719
D650,152	S *	12/2011	Abrams	D2/719
D650,153	S *	12/2011	Chopak	D2/719
D654,248	S *	2/2012	Abrams	D2/719
8,166,572	B1 *	5/2012	Campbell	A47G 9/086 2/69.5
D677,859	S *	3/2013	Andes	D2/825
8,464,374	B1	6/2013	Thayer	
D693,987	S *	11/2013	Wagner	D2/719
8,578,515	B1 *	11/2013	Petersen	A41D 11/00 2/69.5

(Continued)

OTHER PUBLICATIONS

Picture Organic Clothing, "Picture Accessories," Fall/Winter 2015/2016 Catalog, at least as early as Feb. 7, 2015, p. 72.
 (Continued)

Primary Examiner — George D Kirschbaum
Assistant Examiner — Clese Moore, Jr.

(74) *Attorney, Agent, or Firm* — Leanne Taveggia Farrell; Westman, Champlin & Koehler, P.A.

(57) **CLAIM**

The ornamental design for a sleeping bag, as shown and described.

DESCRIPTION

FIG. 1 is a perspective view of a sleeping bag showing our new design;
 FIG. 2 is a front view thereof;
 FIG. 3 is a back view thereof;
 FIG. 4 is a left side view thereof;
 FIG. 5 is a right side view thereof;
 FIG. 6 is a top view thereof;
 FIG. 7 is a bottom view thereof;
 FIG. 8 is a perspective view of the sleeping bag in an alternate position with environment;
 FIG. 9 is a perspective view of FIG. 8 with environment removed;
 FIG. 10 is a front view of FIG. 9;
 FIG. 11 is a back view of FIG. 9;
 FIG. 12 is a left side view of FIG. 9;
 FIG. 13 is a right side view of FIG. 9;
 FIG. 14 is a top view of FIG. 9; and,
 FIG. 15 is a bottom view of FIG. 9.
 The uniform broken lines in the drawings illustrate stitching, which forms part of the claimed design; whereas, the non-uniform broken lines in the drawings illustrate environment and portions of the sleeping bag, which form no part of the claimed design.

1 Claim, 7 Drawing Sheets

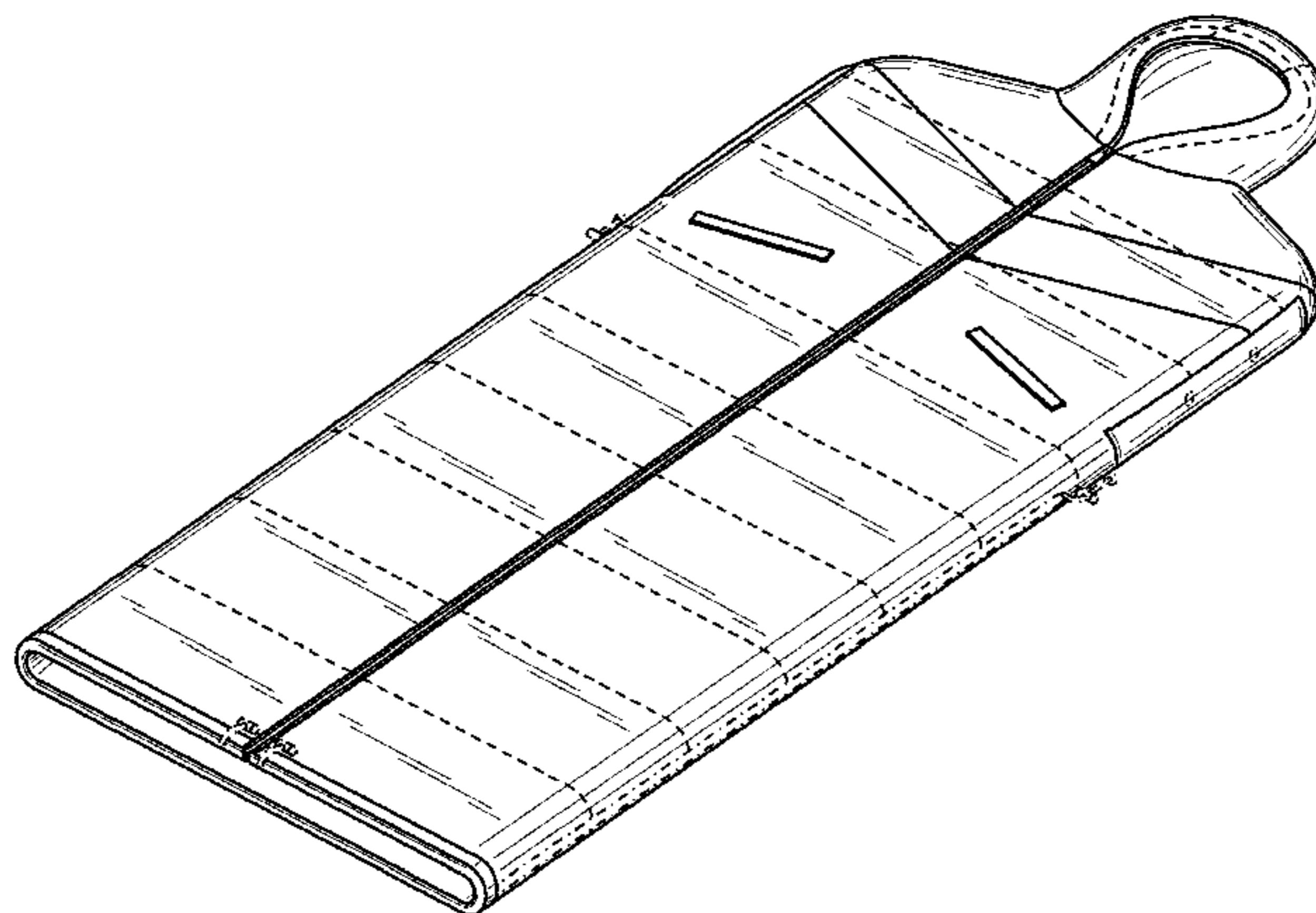

(56)

References Cited

U.S. PATENT DOCUMENTS

D715,028 S * 10/2014 Harris D2/719
D721,467 S * 1/2015 Tref D2/724
D737,023 S * 8/2015 Tolbert D2/719
2007/0050882 A1* 3/2007 Eisenhuth A41D 13/00
2/69
2008/0235848 A1* 10/2008 Wilder A41B 13/06
2/69.5
2012/0260394 A1* 10/2012 Poore A41D 15/04
2/69.5
2015/0143602 A1* 5/2015 Sparks A41D 15/04
2/69.5
2015/0230526 A1* 8/2015 Flora A47G 9/08
5/413 R

OTHER PUBLICATIONS

Web Urbanist, "Padding Around: 12 Cozy Wearable Sleeping Bags", <http://weburbanist.com/2012/07/01/padding-around-12-cozy-wearable-sleeping-bags/>, at least as early as Aug. 29, 2014, 17 pages.
Military Mart, "Austrian Sniper Sleeping Bag", http://www.militarymart.co.uk/index.php?_a=product&product_id=1127, at least as early as Feb. 12, 2015, 3 pages.
Sierra Designs, "Garment-Style Sleeping Bag", <https://www.sierradesigns.com/sleeping-bags/garment-style>, at least as early as Aug. 29, 2014, 10 pages.

* cited by examiner

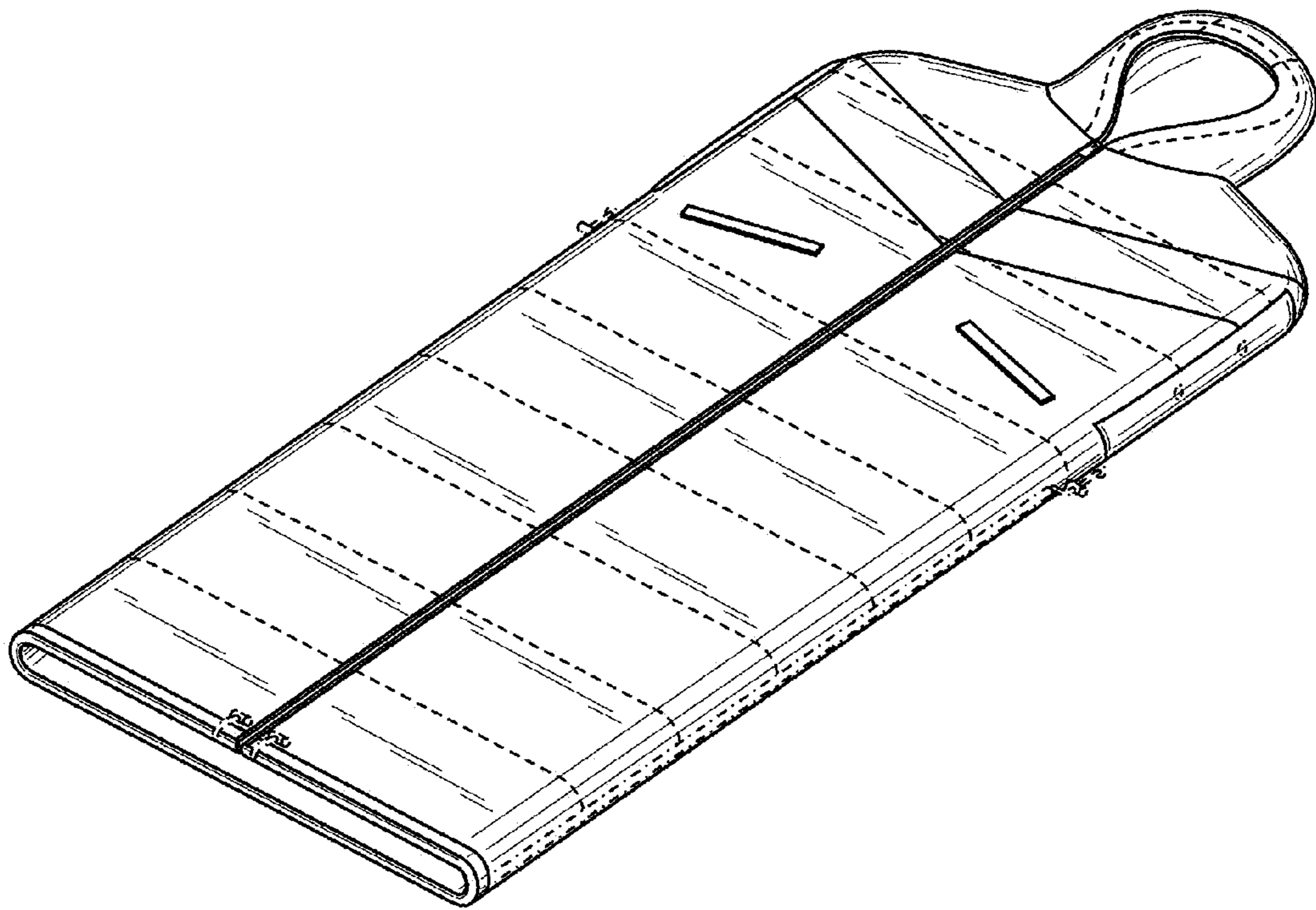

Fig. 1

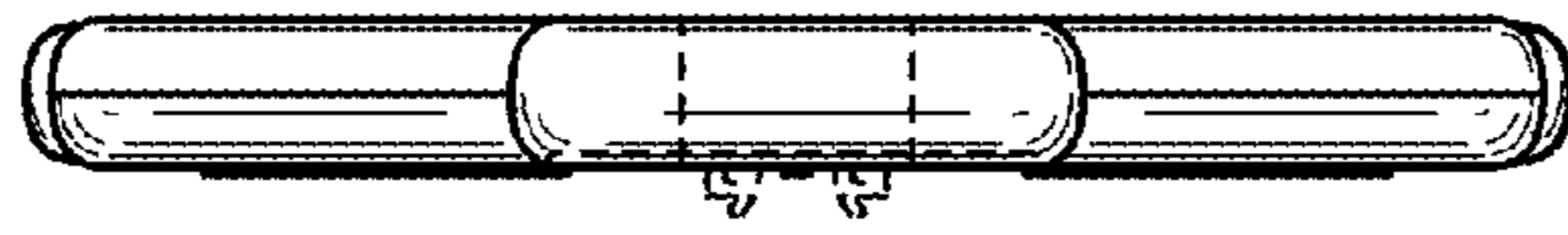

Fig. 6

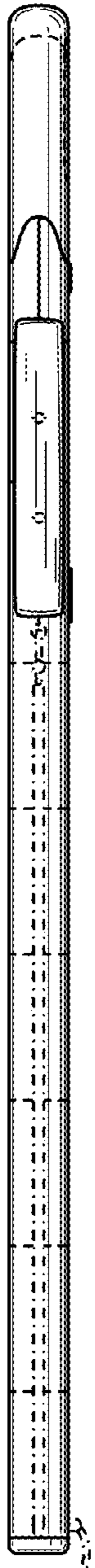

Fig. 4

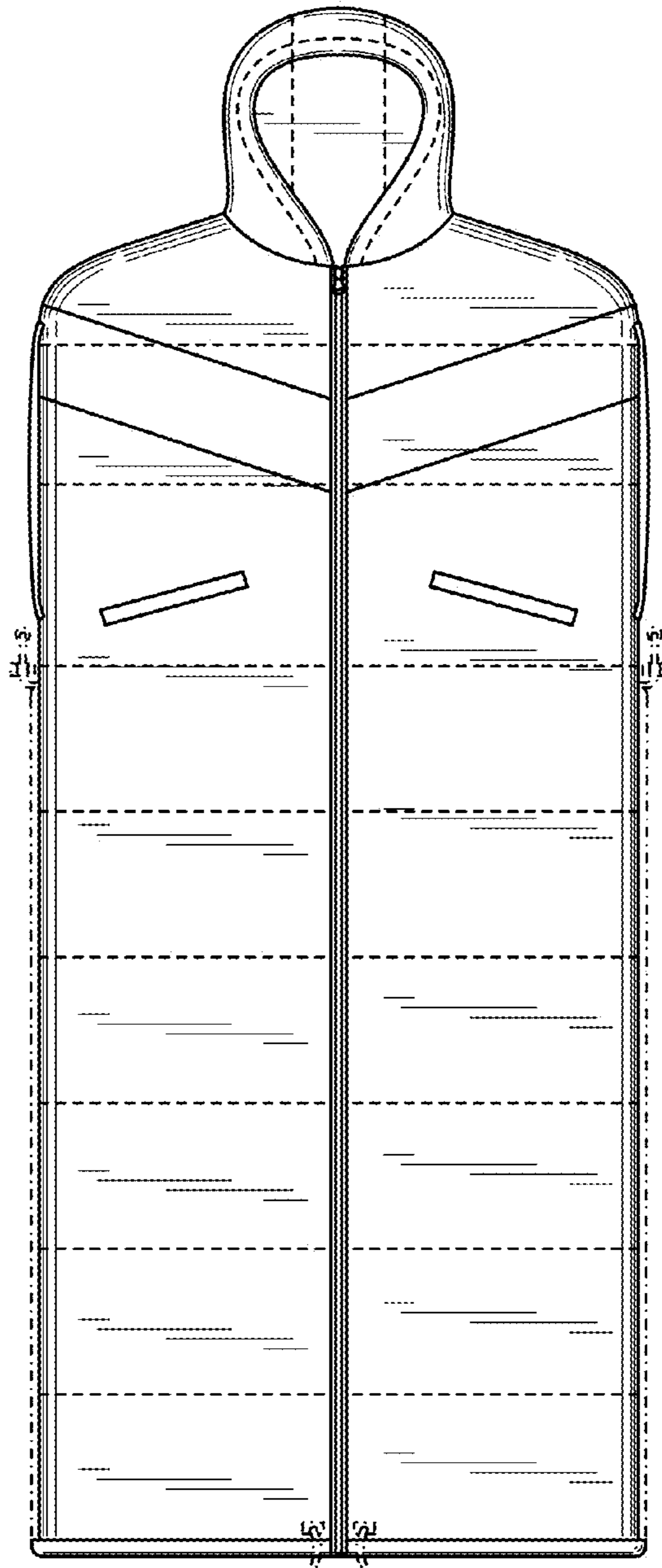

Fig. 2



Fig. 5

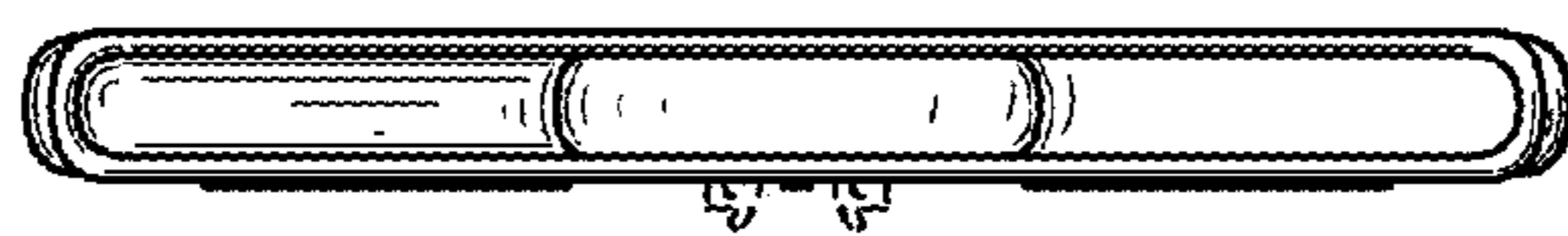

Fig. 7

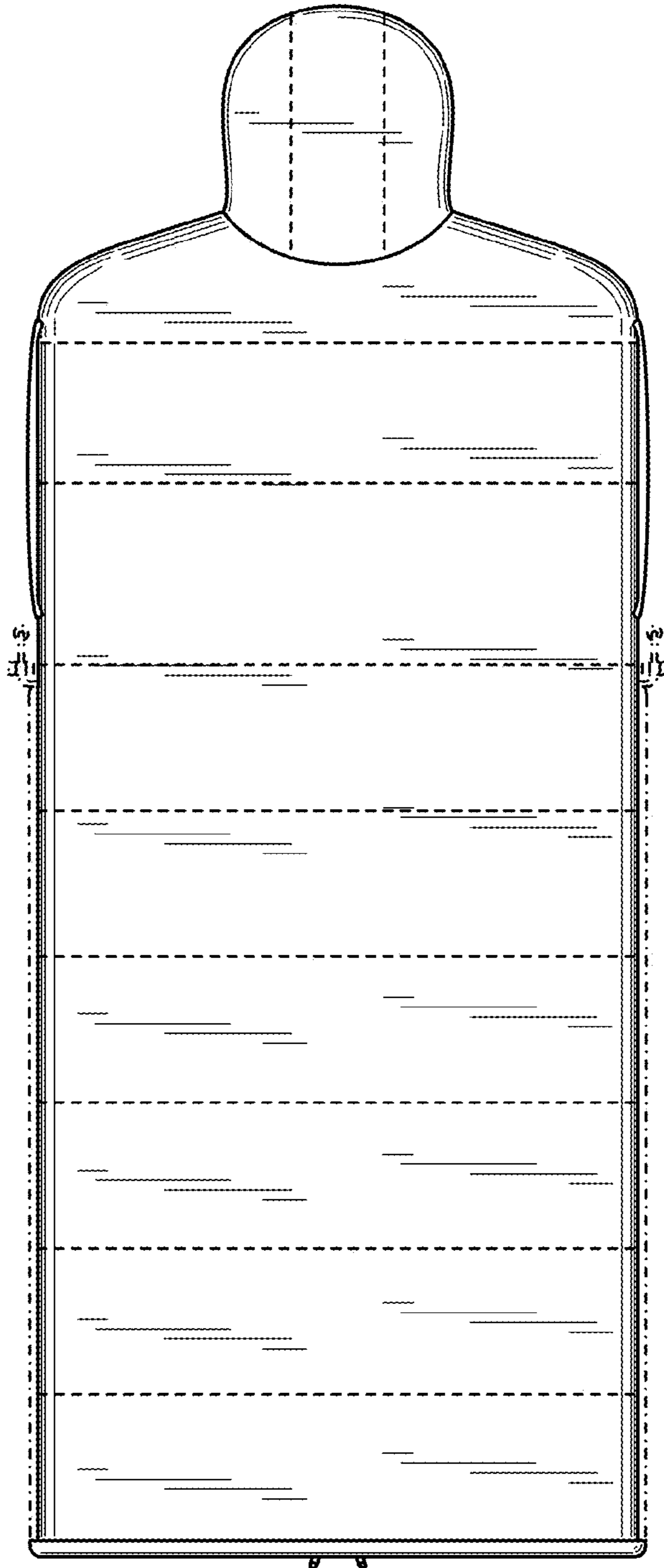

Fig. 3

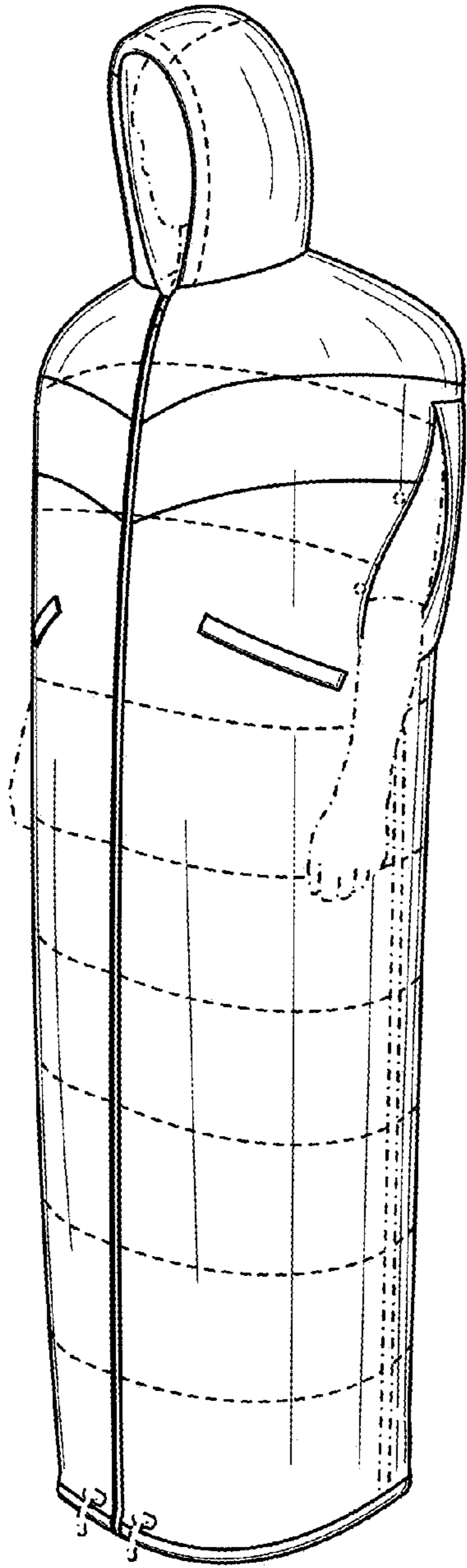

Fig. 8

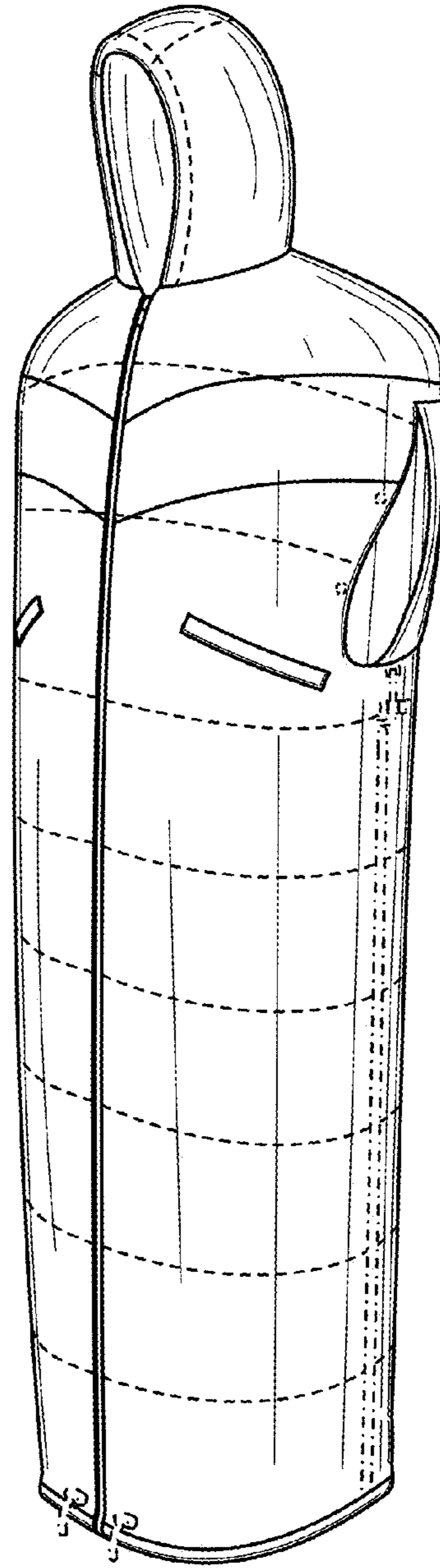

Fig. 9

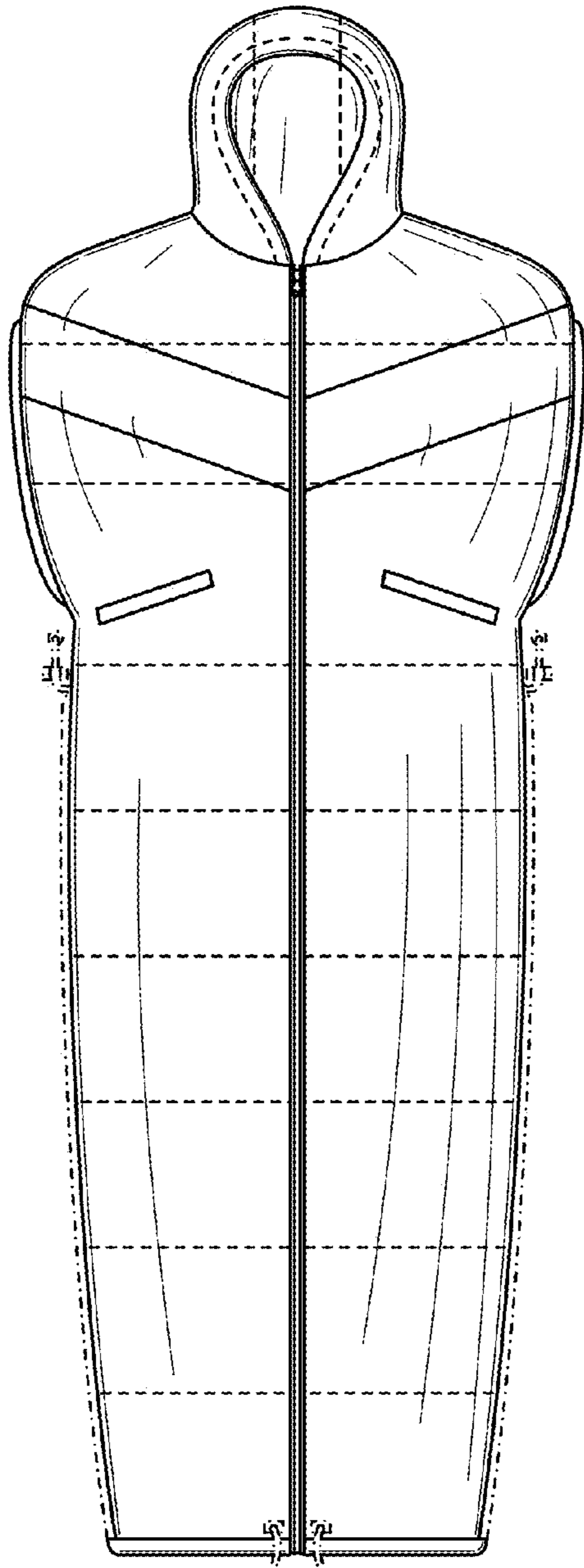

Fig. 10

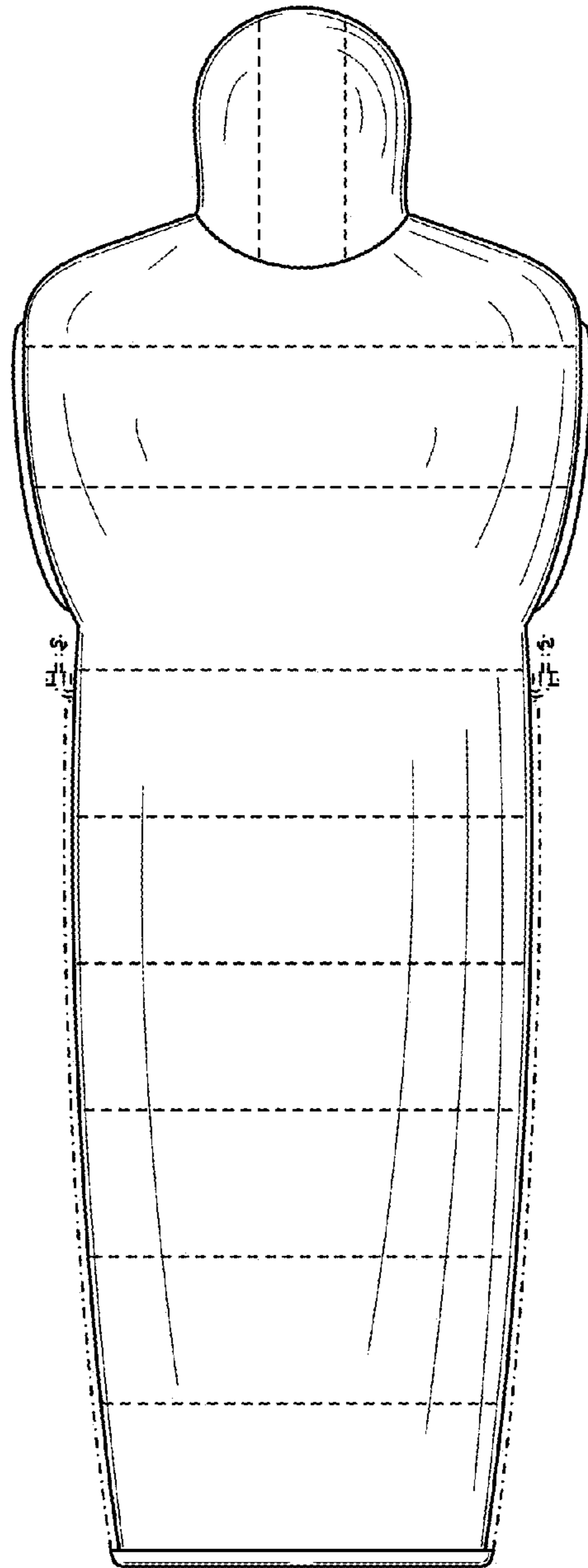

Fig. 11

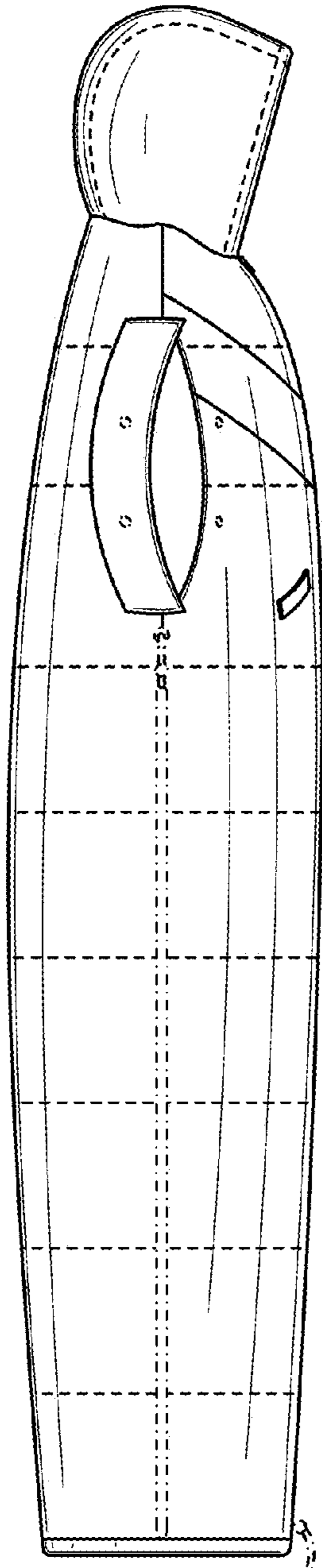

Fig. 12

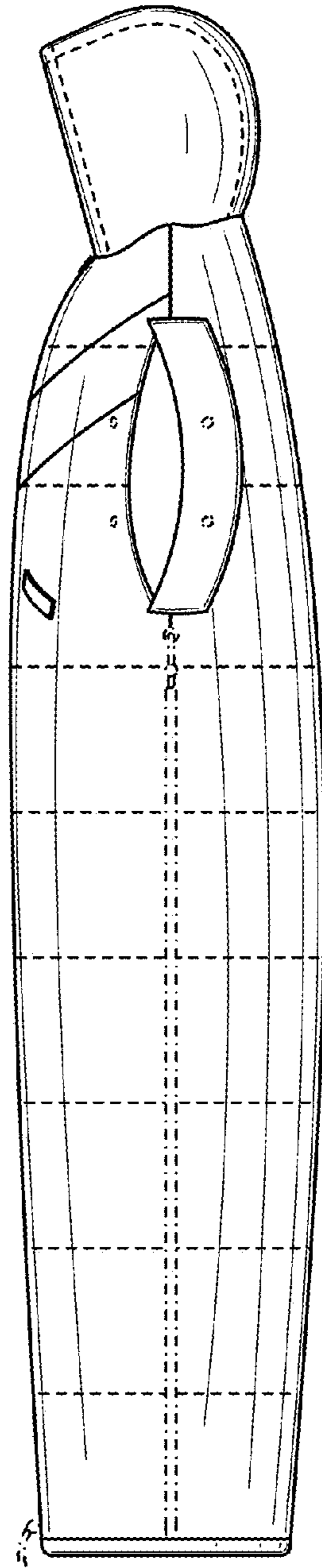

Fig. 13

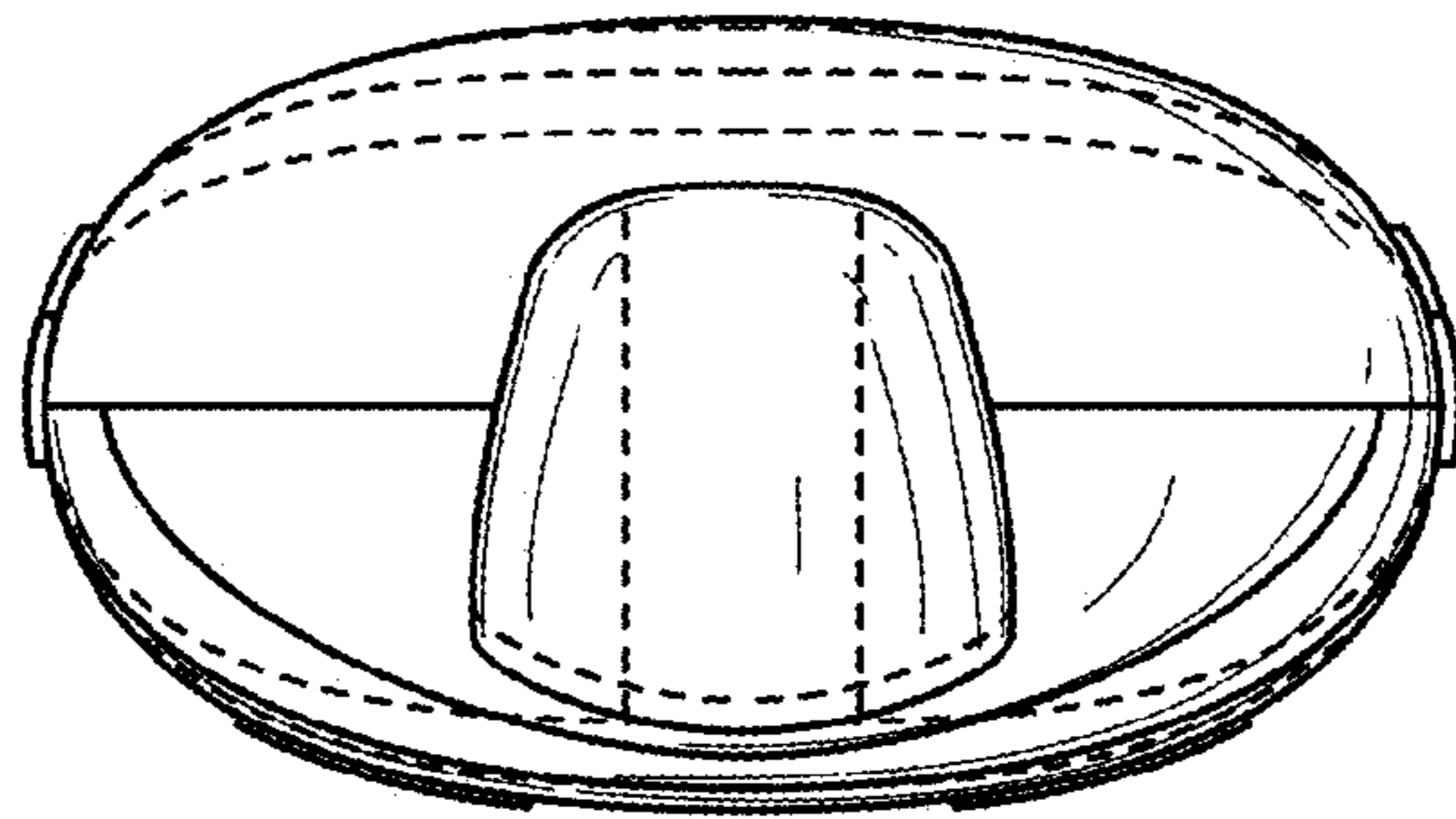

Fig. 14

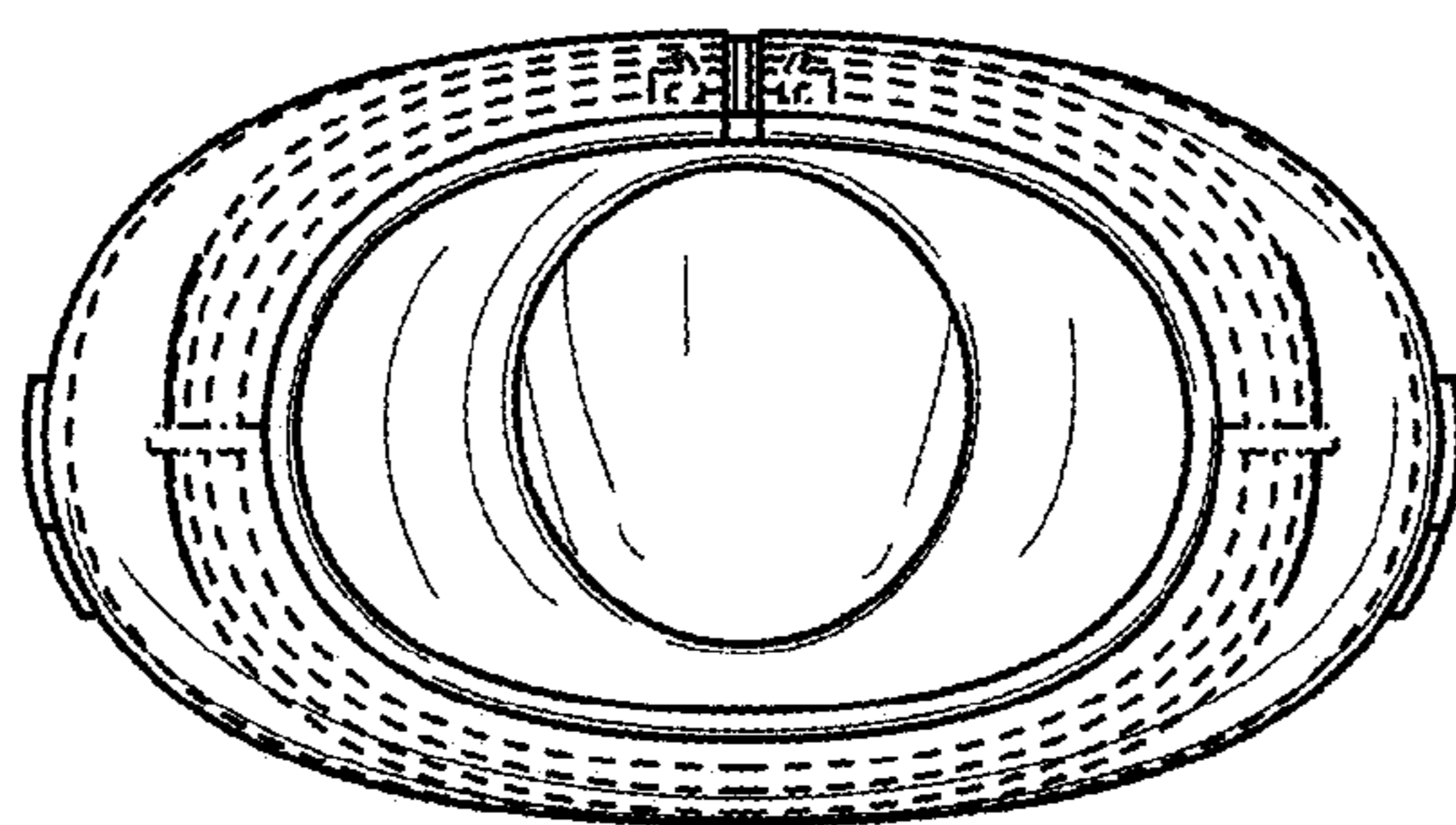

Fig. 15