



US00D765916S

(12) **United States Design Patent** (10) **Patent No.:** **US D765,916 S**
Allan et al. (45) **Date of Patent:** **** Sep. 6, 2016**

(54) **VENTILATION GARMENT** 3,967,459 A * 7/1976 Denis B63C 11/02
 128/202.14
 (71) Applicant: **Draeger Safety UK Limited**, Blyth, 4,948,023 A * 8/1990 Tripp A45F 3/16
 Northumberland (GB) 222/175
 5,433,288 A * 7/1995 James A62C 33/04
 182/3
 (72) Inventors: **Jason Edward Allan**, North Shields 5,607,258 A * 3/1997 Eungard B63C 11/2245
 (GB); **Ian Douglas Tennick**, 224/650
 Cramlington (GB) 6,176,645 B1 * 1/2001 Semeia A45C 13/30
 2/312
 (73) Assignee: **Draeger Safety UK Limited** (GB) D600,859 S * 9/2009 Hill D29/101.1
 8,104,653 B1 * 1/2012 Leung A45F 3/04
 224/148.2
 (**) Term: **14 Years** D668,393 S * 10/2012 Hogbin D29/101.1
 8,312,600 B2 * 11/2012 Colorado A62B 9/04
 224/637
 (21) Appl. No.: **29/524,362** 8,622,268 B2 * 1/2014 Townsend A62B 25/00
 128/205.22
 (22) Filed: **Apr. 20, 2015** 8,925,774 B2 * 1/2015 Mori A01D 34/902
 224/259

(30) **Foreign Application Priority Data**

Oct. 21, 2014 (EM) 002561621

(51) **LOC (10) Cl.** **29-02**

(52) **U.S. Cl.**
USPC **D29/101.1**

(58) **Field of Classification Search**
USPC D29/100, 101.1–101.4, 122, 124;
D2/626, 628, 629; D3/215, 218, 219,
D3/221, 226, 322, 327; D24/190; 359/362,
359/519; 182/3, 4, 5, 6, 9, 133; 2/300, 310,
2/311; D10/111; 224/259, 576, 603, 606,
224/623, 627, 647; D21/683; D30/152;
119/770; 297/485
CPC A45F 5/00
See application file for complete search history.

(56) **References Cited**

U.S. PATENT DOCUMENTS

1,340,012 A * 5/1920 Cave F41H 9/02
126/271.2 R
3,191,828 A * 6/1965 Senne A42B 9/04
224/604

* cited by examiner

Primary Examiner — Randall Gholson

(74) *Attorney, Agent, or Firm* — DLA Piper LLP (US)

(57) **CLAIM**

The ornamental design for an ventilation garment, as shown and described.

DESCRIPTION

FIG. 1 shows a perspective view of the invention;
 FIG. 2 shows a front view of the invention;
 FIG. 3 shows a back view of the invention;
 FIG. 4 shows a right side view of the invention;
 FIG. 5 shows a left side view of the invention;
 FIG. 6 shows a top view of the invention; and,
 FIG. 7 shows a bottom view of the invention.
 The broken lines shown in the drawings show unclaimed subject matter only and form no part of the claimed design.

1 Claim, 7 Drawing Sheets

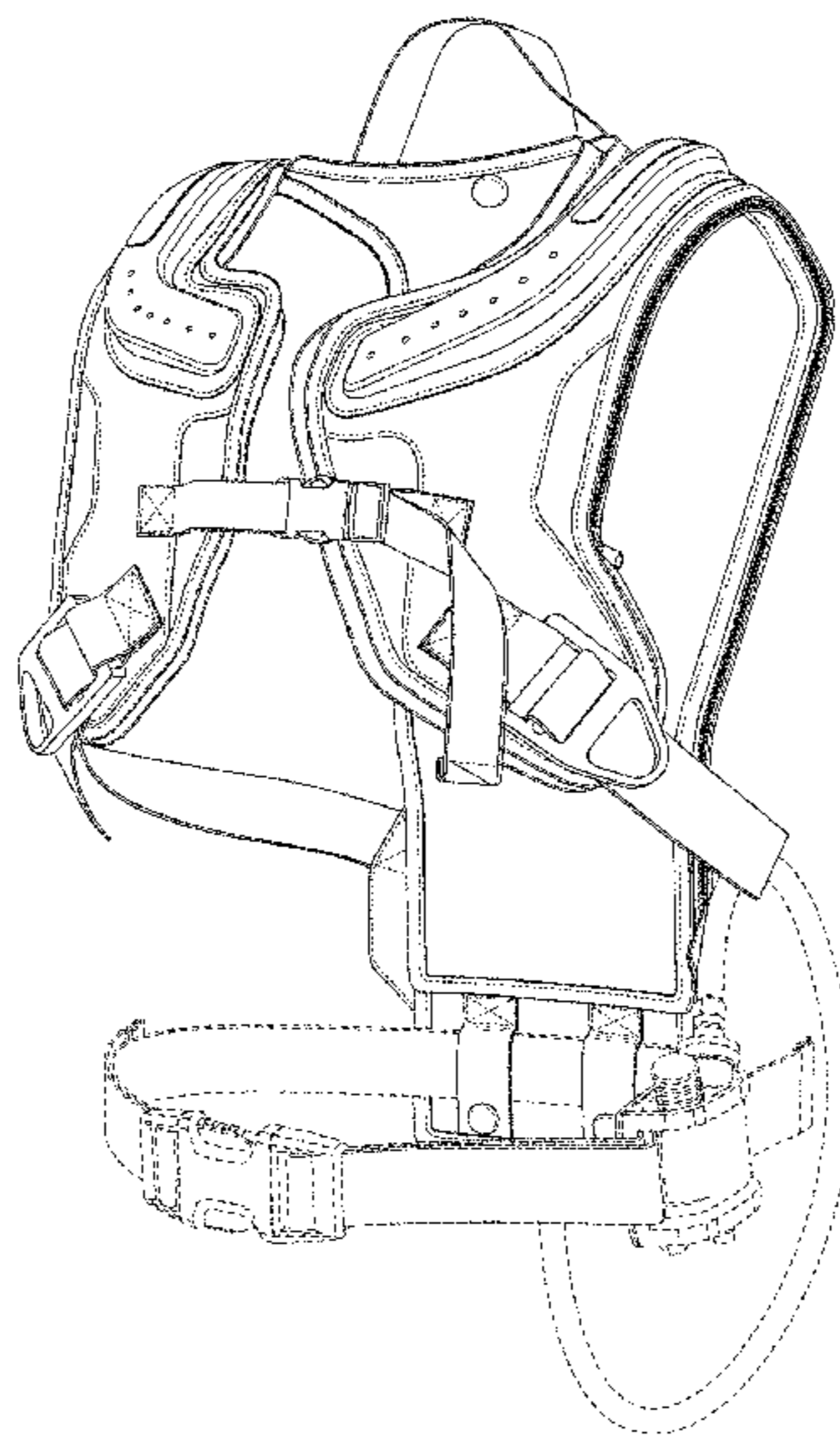

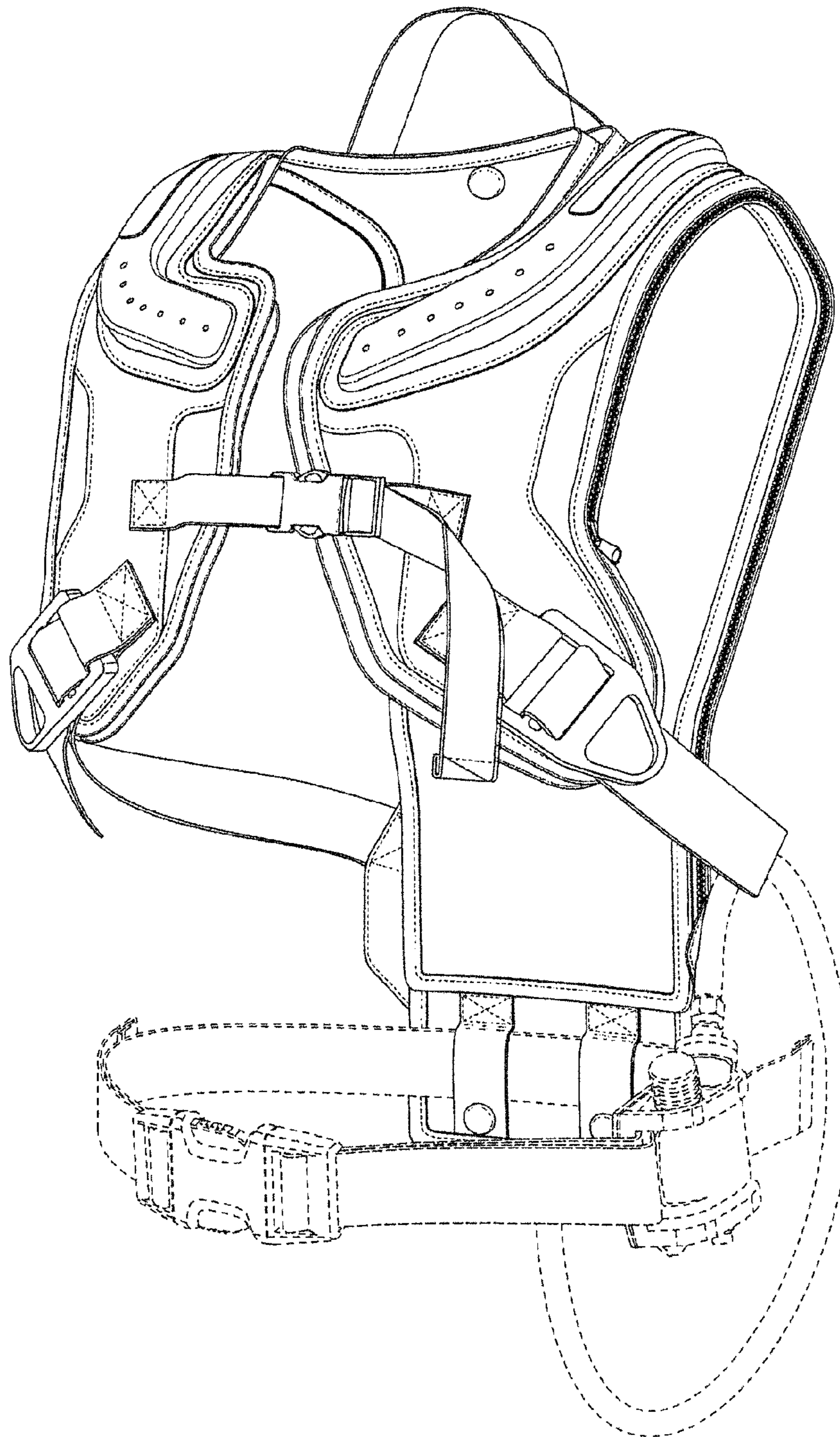

Figure 1

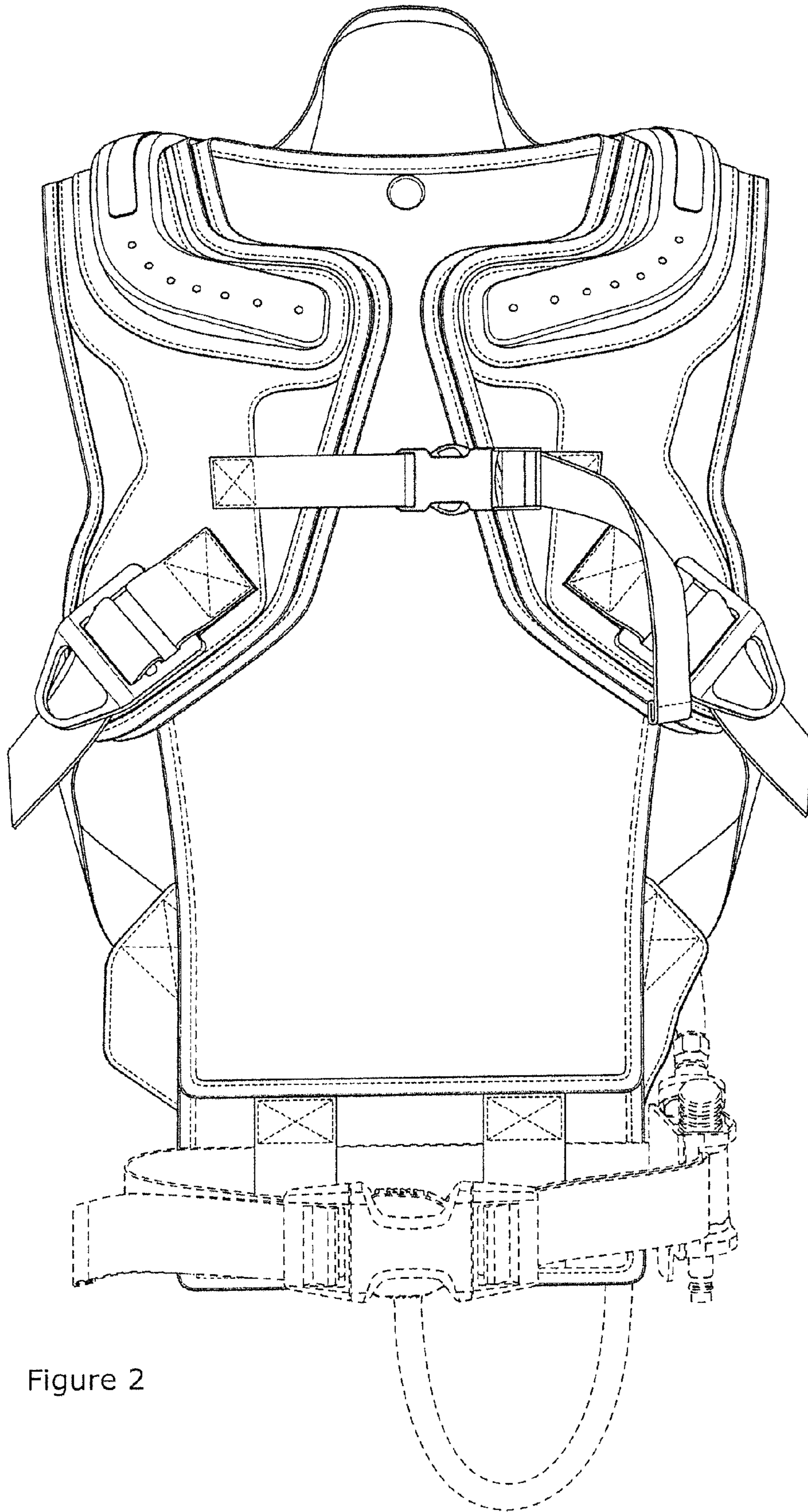

Figure 2

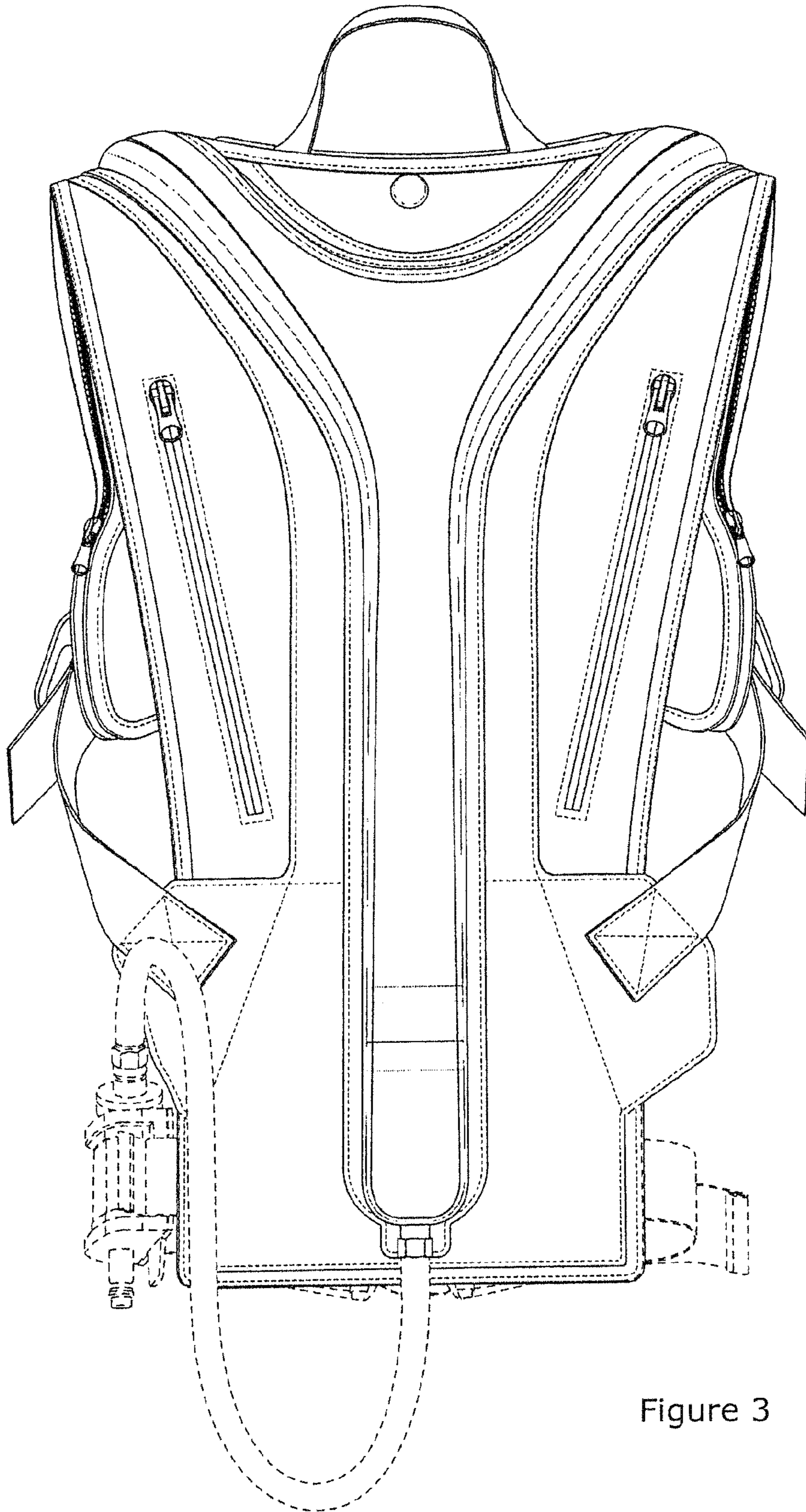

Figure 3

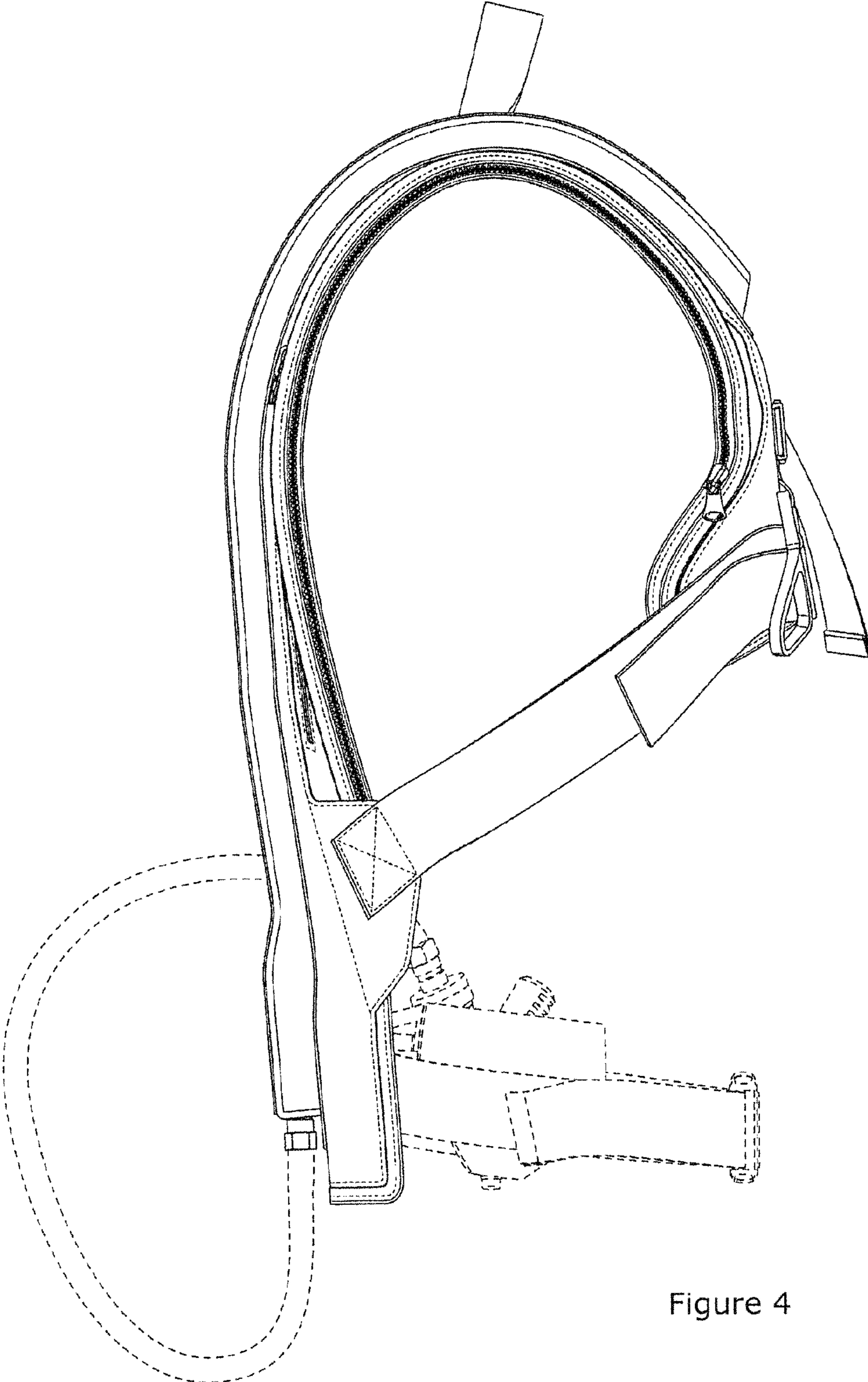

Figure 4

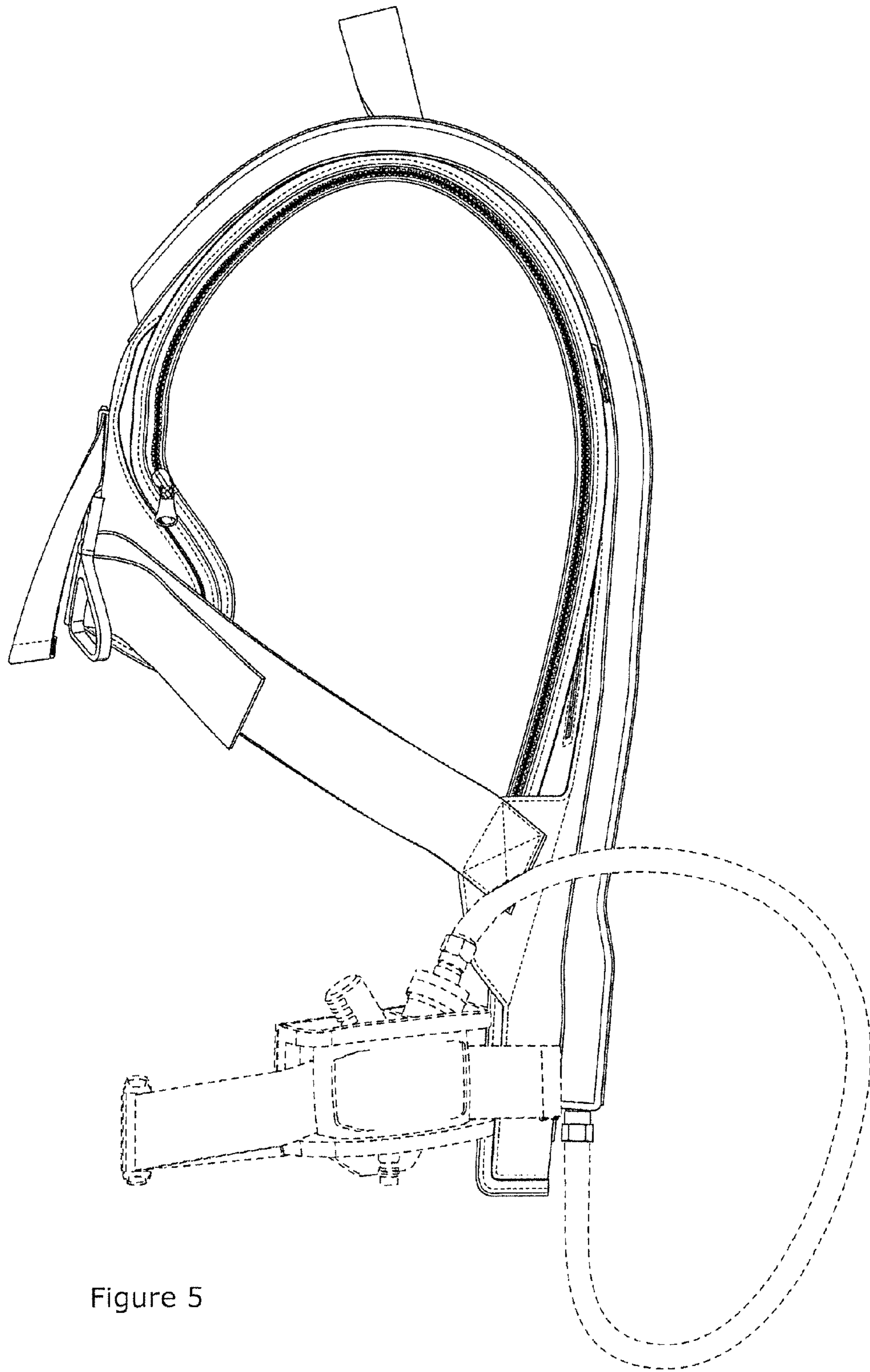

Figure 5

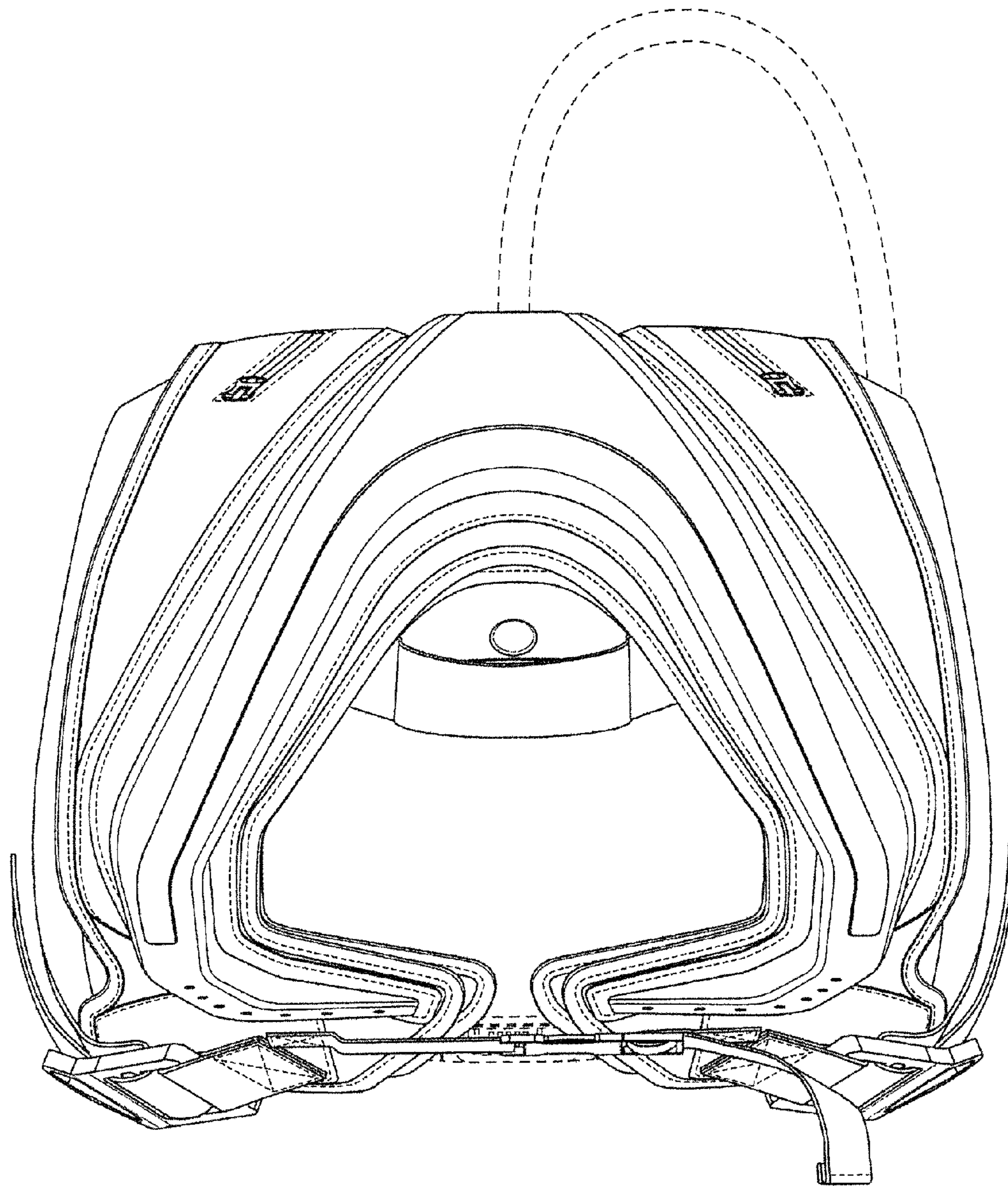

Figure 6

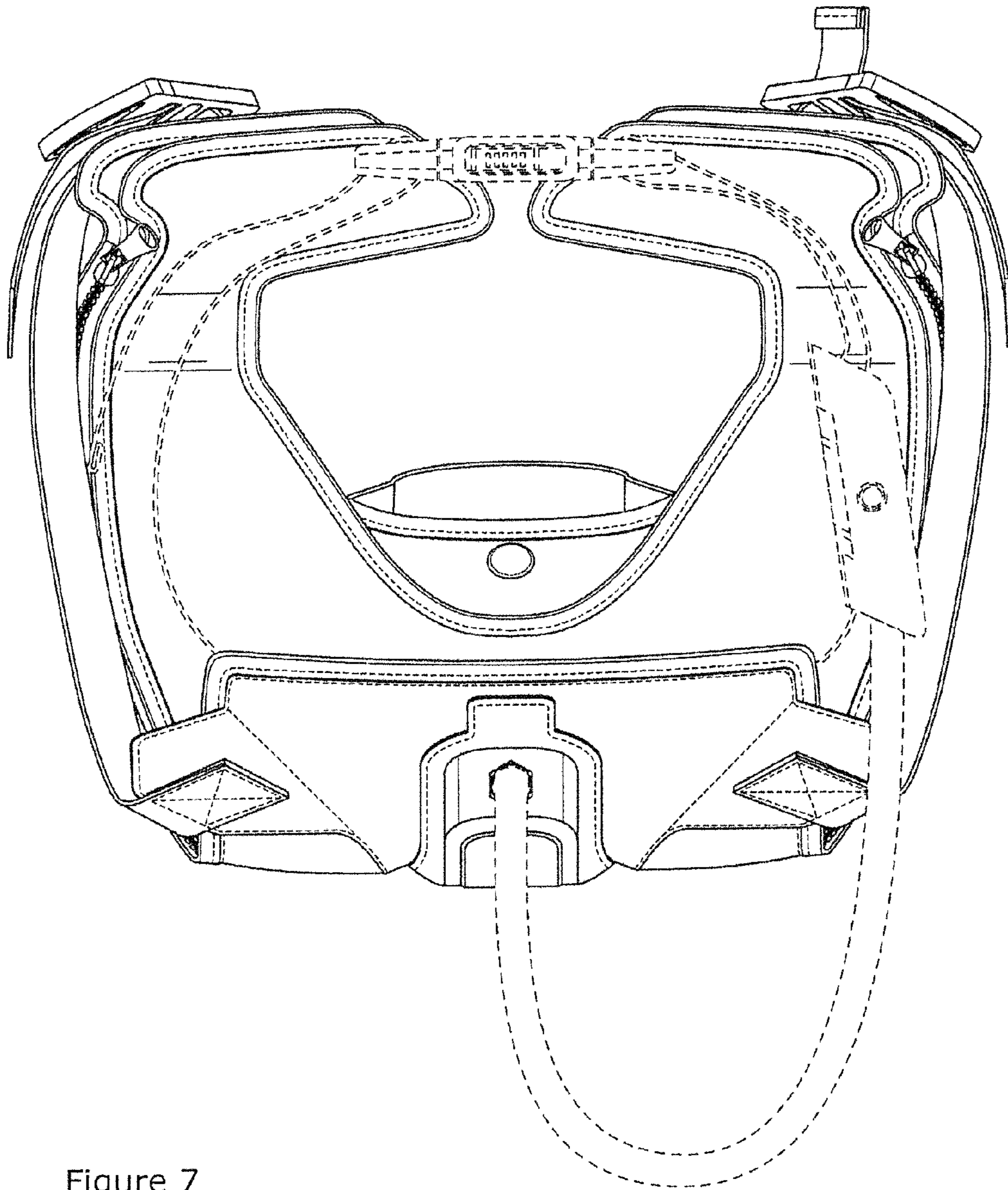

Figure 7