



US00D765915S

(12) **United States Design Patent**  
**Lannie**

(10) **Patent No.:** **US D765,915 S**

(45) **Date of Patent:** **\*\* Sep. 6, 2016**

(54) **DENTAL FLOSSER**

(71) Applicant: **PERI-DENT LIMITED**, London (GB)

(72) Inventor: **Michael Lannie**, Northampton (GB)

(73) Assignee: **PERI-DENT LIMITED**, London (GB)

(\*\*) Term: **14 Years**

(21) Appl. No.: **29/501,583**

(22) Filed: **Sep. 5, 2014**

(30) **Foreign Application Priority Data**

Jul. 22, 2014 (EM) ..... 002507210

(51) **LOC (10) Cl.** ..... **28-03**

(52) **U.S. Cl.**  
USPC ..... **D28/66**

(58) **Field of Classification Search**  
USPC ..... D28/31, 56, 65-68, 73; D24/152;  
433/141, 146-147; 132/322-329  
CPC ..... A61C 15/04; A61C 15/00; A61C 15/02;  
A61C 15/041; A61C 15/042; A61C 15/043;  
A61C 15/045; A61C 15/046; A61C 15/047;  
A61C 15/048

See application file for complete search history.

(56) **References Cited**

**U.S. PATENT DOCUMENTS**

D401,701 S \* 11/1998 Chodorow ..... D28/66  
D578,254 S \* 10/2008 Grendol ..... D28/66

D610,748 S \* 2/2010 Volpenhein et al. .... D28/66  
D612,104 S \* 3/2010 Chodorow et al. .... D28/66  
D618,396 S \* 6/2010 Volpenhein et al. .... D28/66  
D641,522 S \* 7/2011 Nanda ..... D28/66  
D649,713 S \* 11/2011 Kollar ..... D28/66  
D655,044 S \* 2/2012 Nanda ..... D28/66  
D679,864 S \* 4/2013 Erskine-Smith ..... D28/66  
2004/0040572 A1\* 3/2004 Chodorow ..... 132/323  
2014/0130824 A1\* 5/2014 Fisher et al. .... 132/323

\* cited by examiner

*Primary Examiner* — Zenia Bennett

(74) *Attorney, Agent, or Firm* — Tillman Wright, PLLC;  
Chad D. Tillman; James D. Wright

(57) **CLAIM**

The ornamental design for a dental flosser, as shown and described.

**DESCRIPTION**

FIG. 1 is a perspective view of a top of a dental flosser in accordance with the present invention.

FIG. 2 is another perspective view of the top of the dental flosser of FIG. 1.

FIG. 3 is a plan view of the top of the dental flosser of FIG. 1.

FIG. 4 is a plan view of a bottom of the dental flosser of FIG. 1.

FIG. 5 is an elevational view of a first end of the dental flosser of FIG. 1.

FIG. 6 is an elevational view of a second end of the dental flosser of FIG. 1; and,

FIG. 7 is an elevational view of a side of the dental flosser of FIG. 1.

**1 Claim, 7 Drawing Sheets**

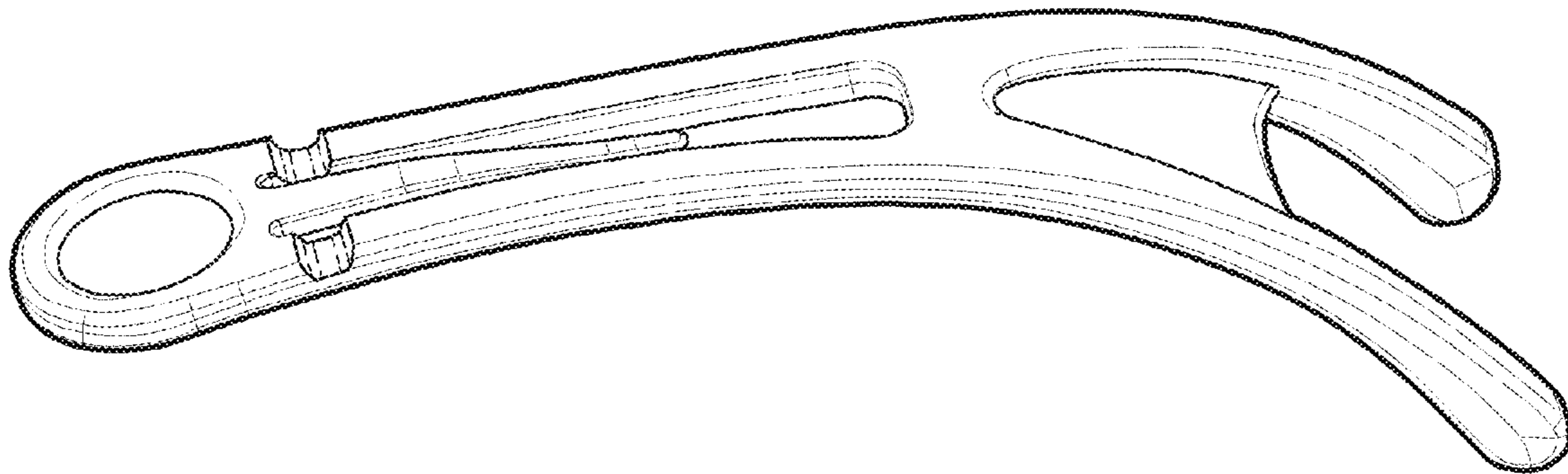

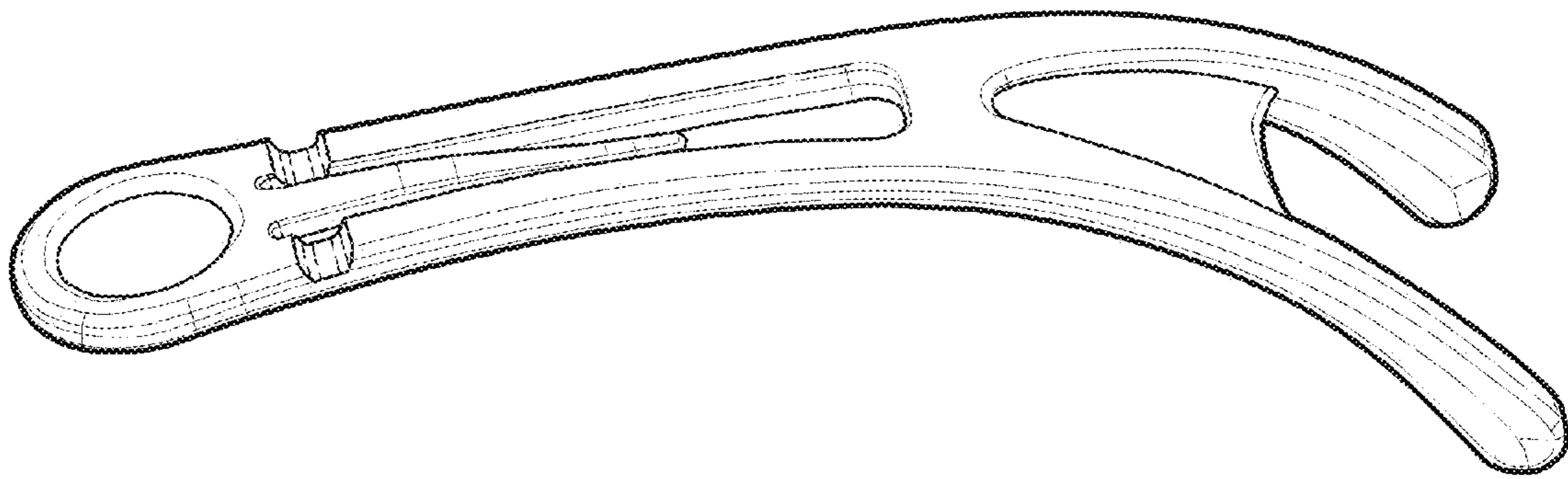

FIG. 1

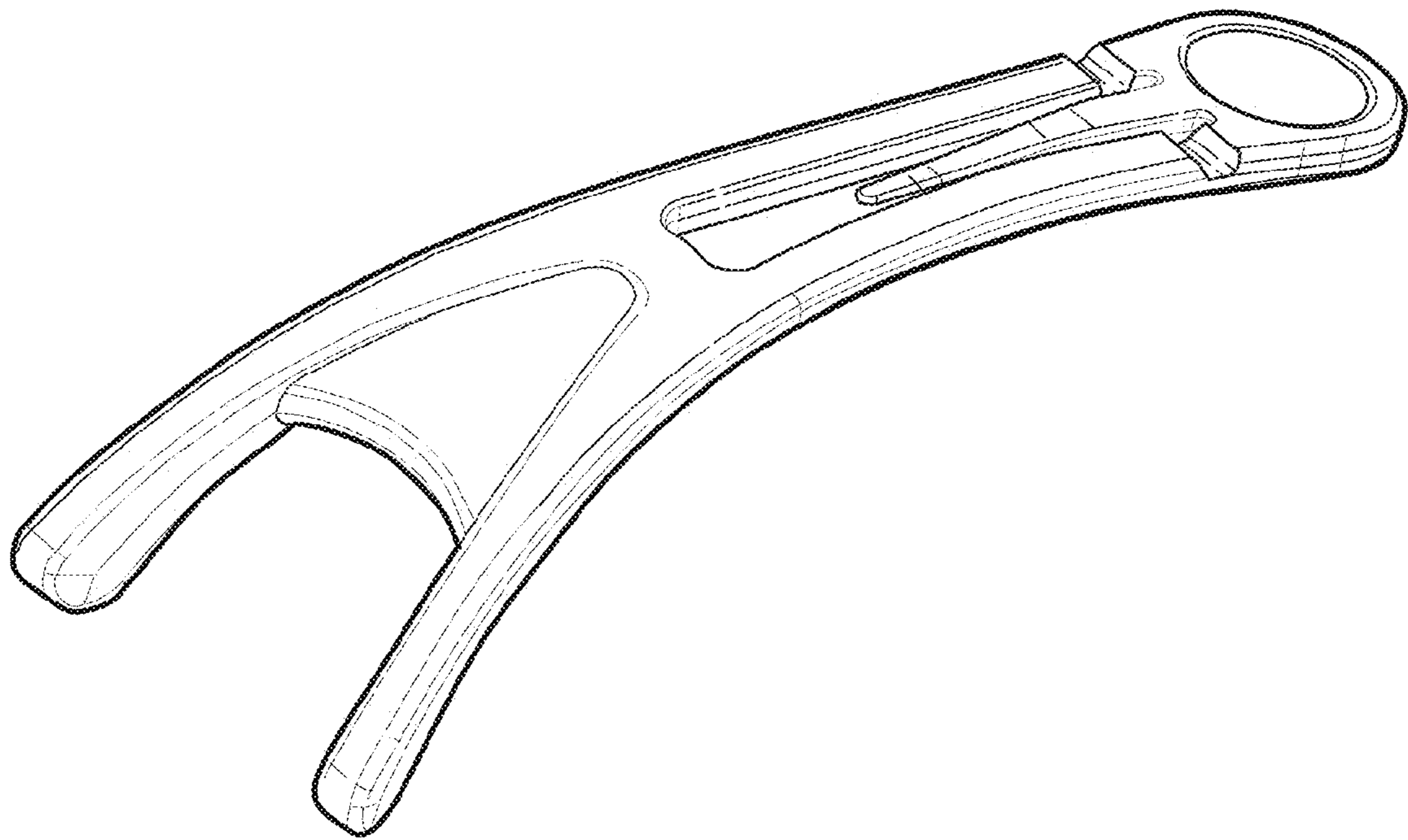

FIG. 2

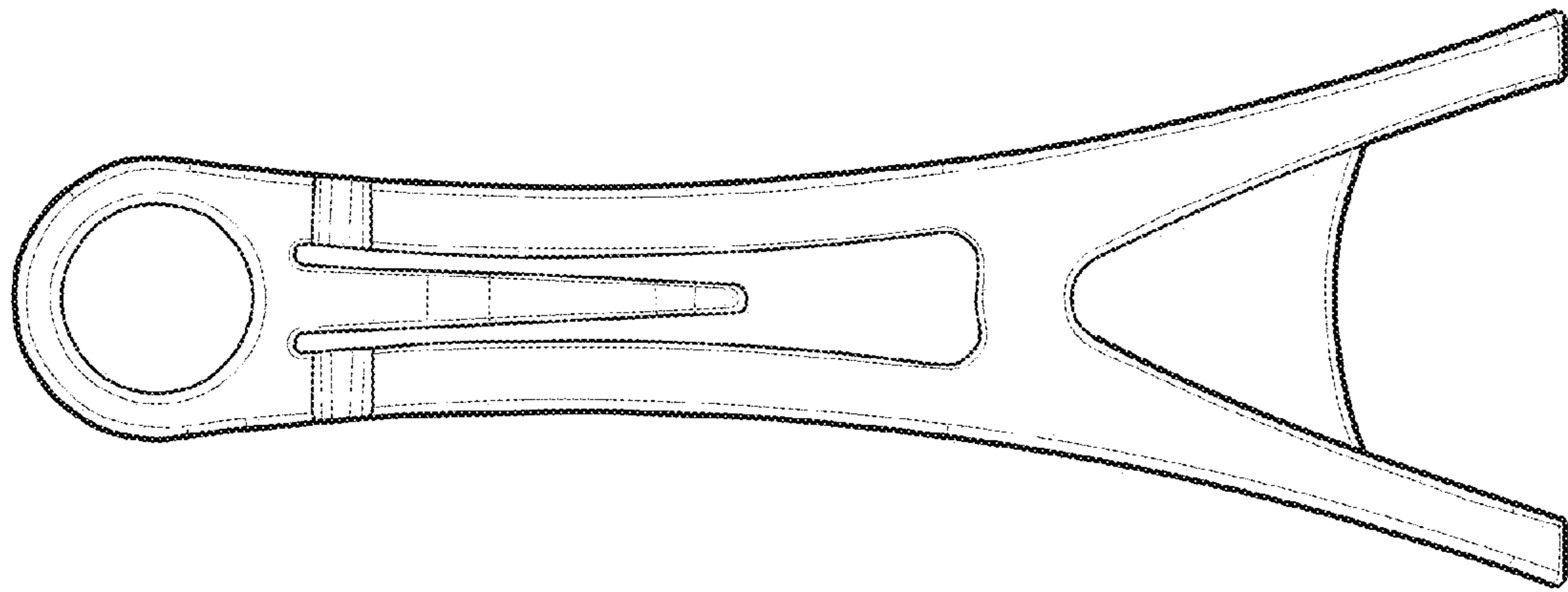

FIG. 3

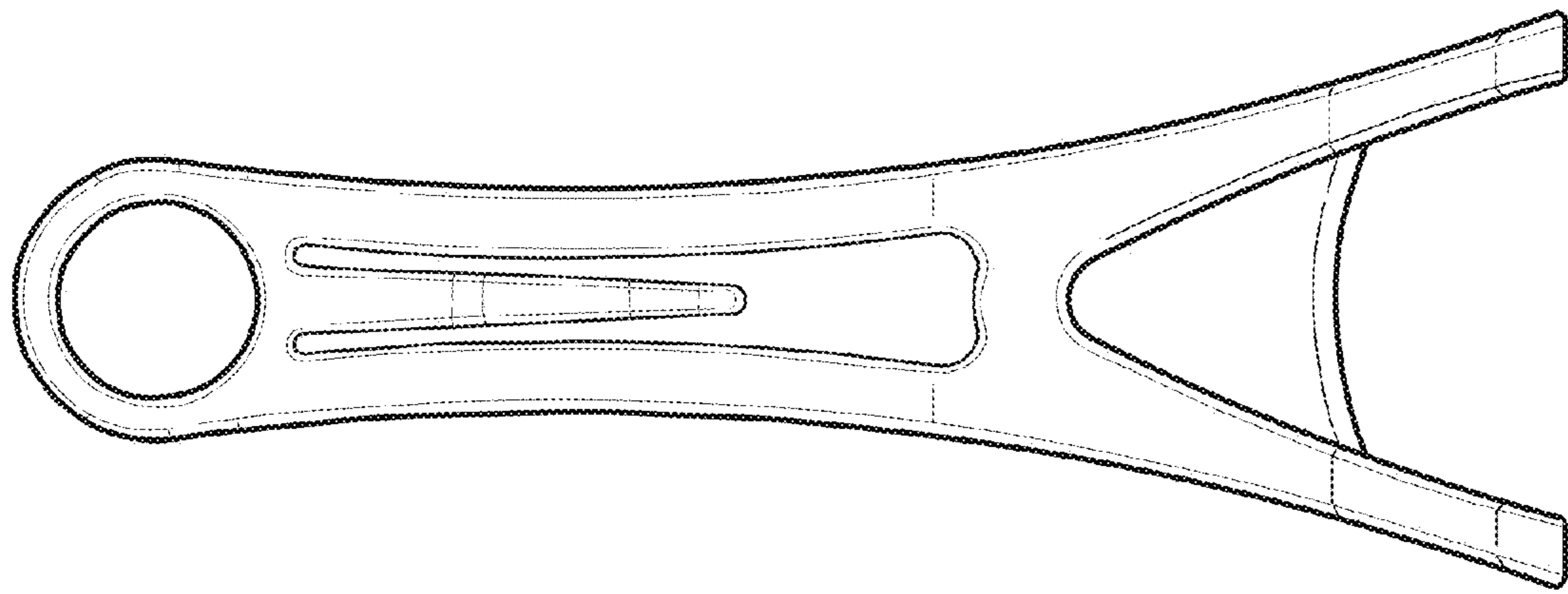

FIG. 4

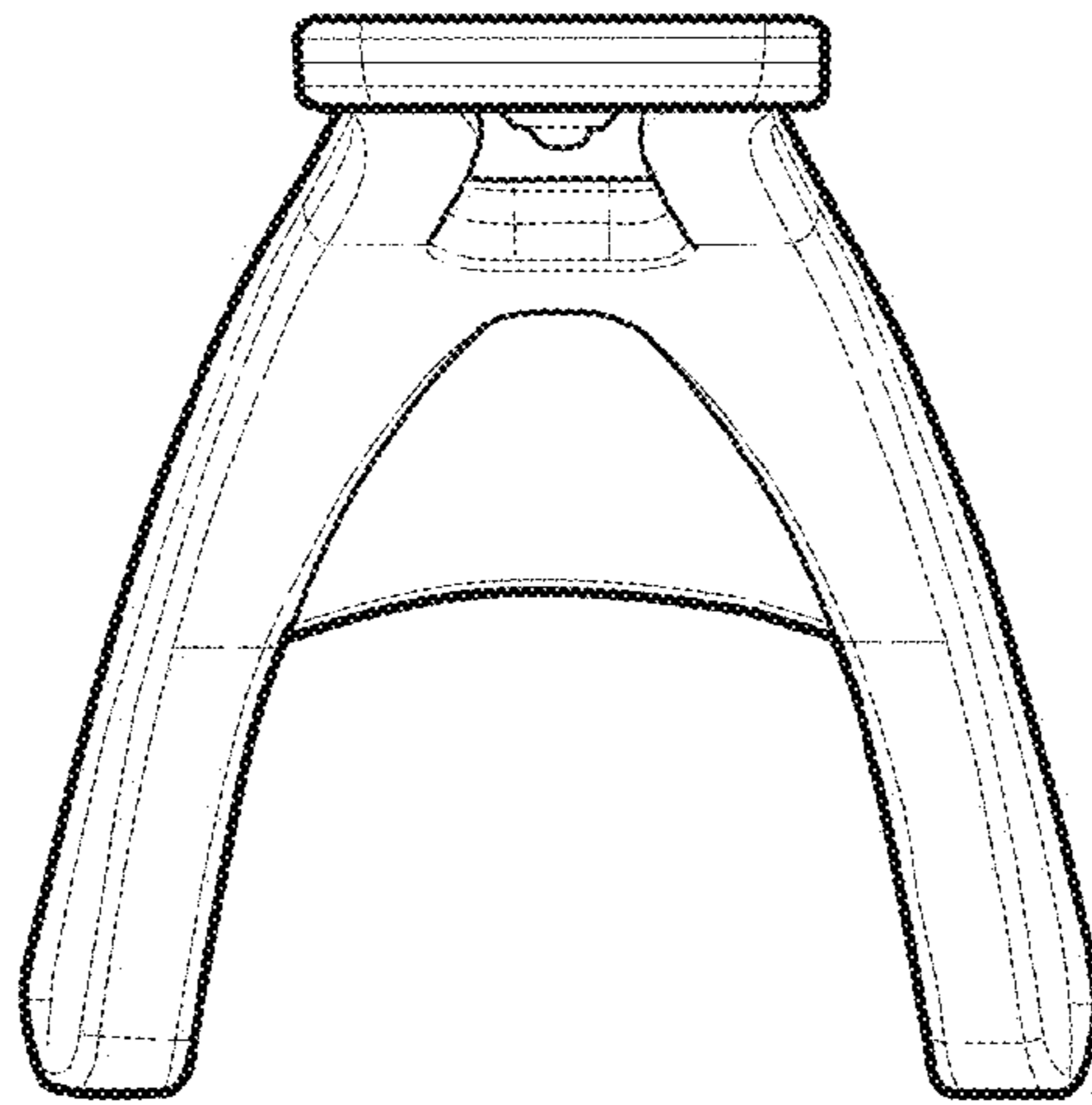

FIG. 5

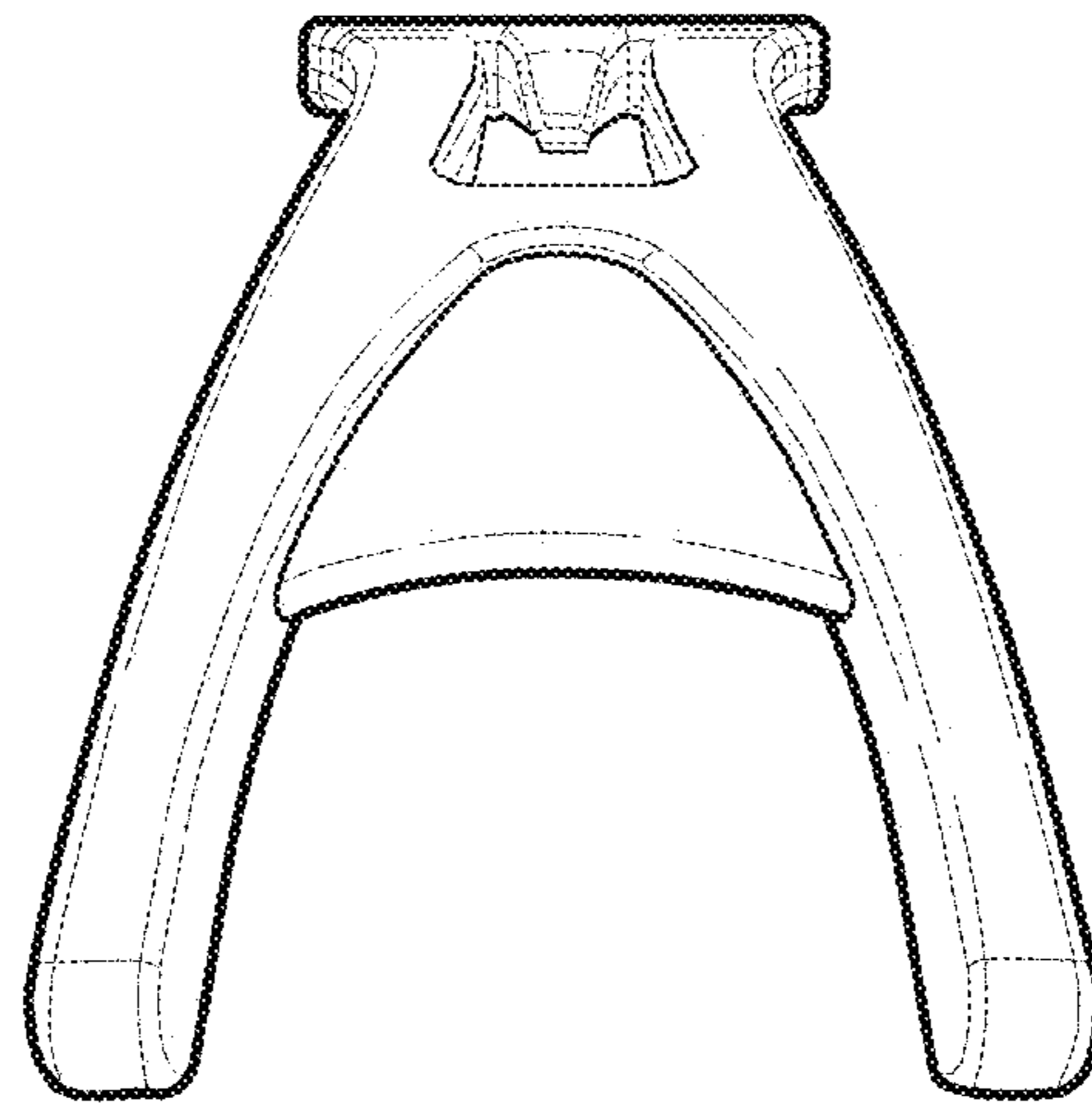

FIG. 6

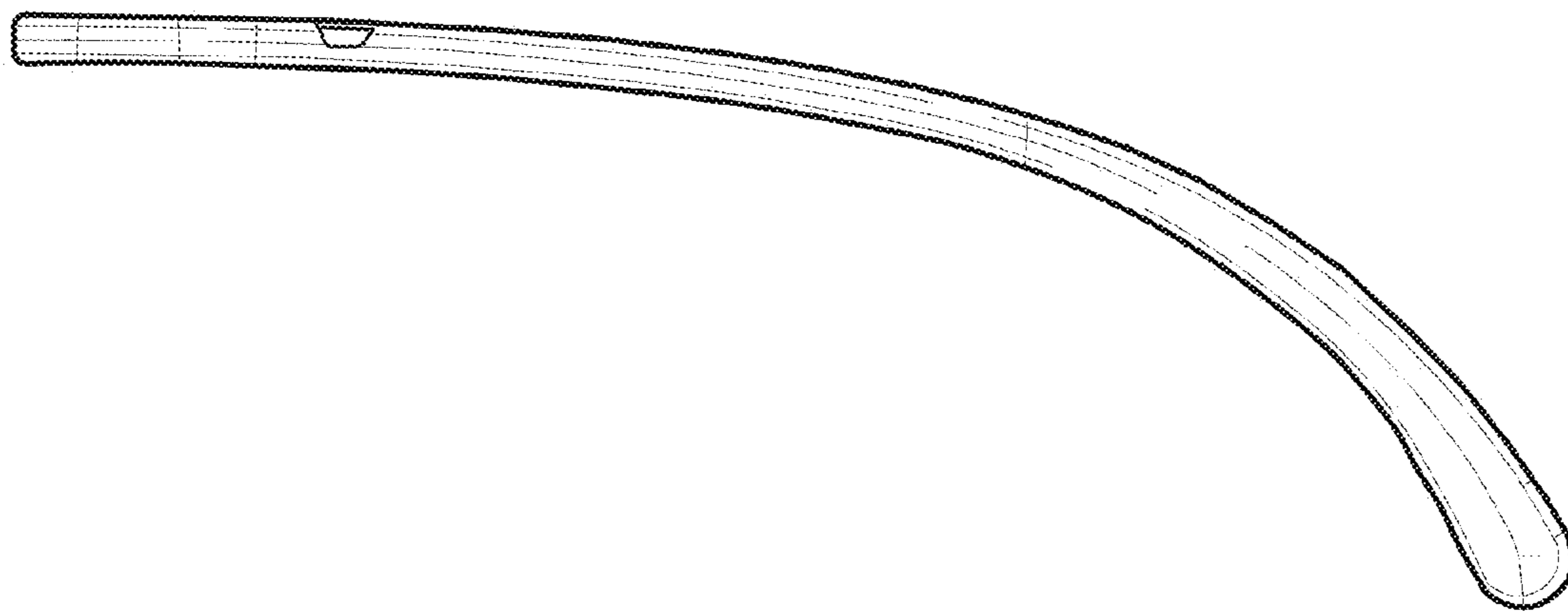

FIG. 7