



US00D765870S

(12) **United States Design Patent** (10) **Patent No.:** **US D765,870 S**
Sedic (45) **Date of Patent:** **** Sep. 6, 2016**

(54) **EYE MASSAGER**

(71) Applicant: **Filip Sedic**, Stockholm (SE)

(72) Inventor: **Filip Sedic**, Stockholm (SE)

(**) Term: **15 Years**

(21) Appl. No.: **29/530,588**

(22) Filed: **Jun. 17, 2015**

(30) **Foreign Application Priority Data**

Jun. 1, 2015 (CN) 2015 3 0173017

(51) **LOC (10) Cl.** **28-03**

(52) **U.S. Cl.**
USPC **D24/200**

(58) **Field of Classification Search**

USPC D24/200, 214-215; D28/38, 41, 73;
D21/682; D4/138; D7/393

CPC A61F 7/00; A61F 7/0001; A61F 7/0003;
A61F 7/0004; A61F 2007/0004; A61F
2007/0087; A61F 2007/0001; A61F
2007/0086; A61H 9/005; A61H 2205/00;
A61H 2205/024; A61H 15/0085; A61H
15/0092

See application file for complete search history.

(56) **References Cited**

U.S. PATENT DOCUMENTS

D212,145 S * 8/1968 Madl D24/214
6,001,070 A * 12/1999 Gebhard A61F 2007/0087
601/15

D481,463 S * 10/2003 Cook D24/200
D706,439 S * 6/2014 Hahr D24/215

D722,383 S * 2/2015 Cole D24/200

D752,298 S * 3/2016 Stephens D24/200

2014/0213945 A1 * 7/2014 Kojima A61H 15/0092
601/137

OTHER PUBLICATIONS

IRIS™ Feb. 24, 2016. [Retrieved on May 5, 2016]. Retrieved from
the Internet: <URL: <http://www.google.com/images>>.*

* cited by examiner

Primary Examiner — Wan Laymon

(74) *Attorney, Agent, or Firm* — Fenwick & West LLP

(57) **CLAIM**

I claim the ornamental design for an eye massager, as shown
and described.

DESCRIPTION

FIG. 1 is a perspective view of a first embodiment of an eye
massager.

FIG. 2 is a front view of the first embodiment of the eye
massager.

FIG. 3 is a back view of the first embodiment of the eye
massager.

FIG. 4 is a right side view of the first embodiment of the eye
massager.

FIG. 5 is a left side view of the first embodiment of the eye
massager.

FIG. 6 is a top view of the first embodiment of the eye
massager.

FIG. 7 is a bottom view of the first embodiment of the eye
massager.

FIG. 8 is a perspective view of a second embodiment of the
eye massager.

FIG. 9 is a front view of the second embodiment of the eye
massager.

FIG. 10 is a back view of the second embodiment of the eye
massager.

FIG. 11 is a right side view of the second embodiment of the
eye massager.

FIG. 12 is a left side view of the second embodiment of the
eye massager.

FIG. 13 is a top view of the second embodiment of the eye
massager; and,

FIG. 14 is a bottom view of the second embodiment of the
eye massager.

The broken lines are directed to environment and are for
illustrative purposes only; the broken lines form no part of
the claimed design.

1 Claim, 12 Drawing Sheets

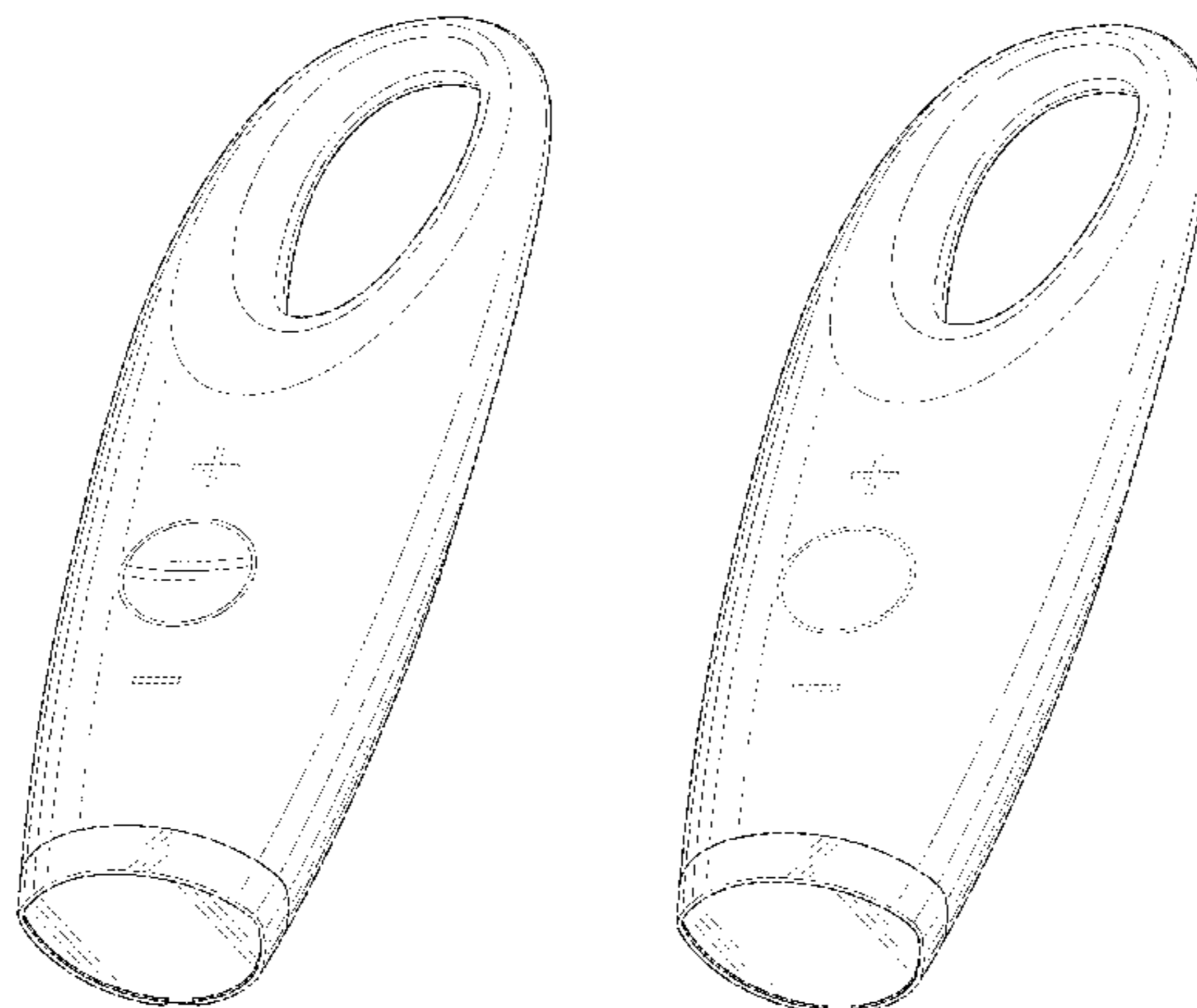

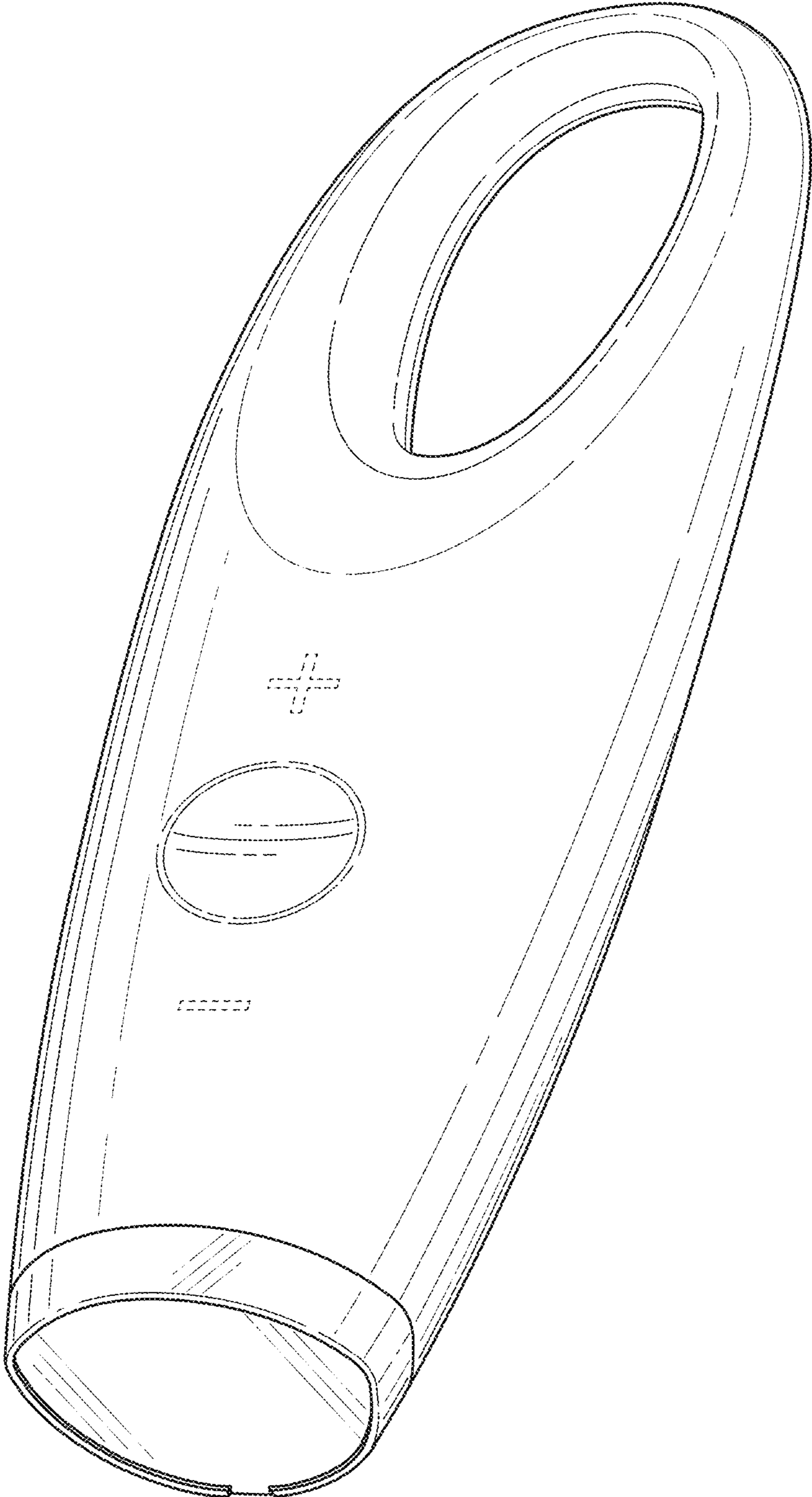

FIG. 1

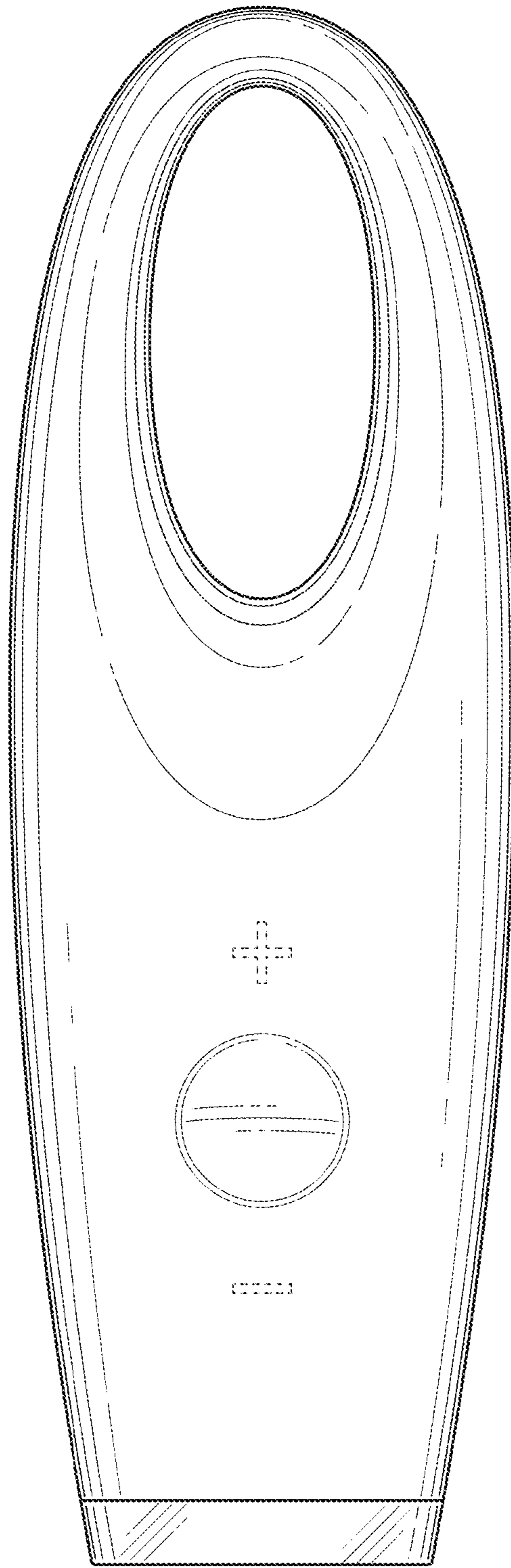

FIG. 2

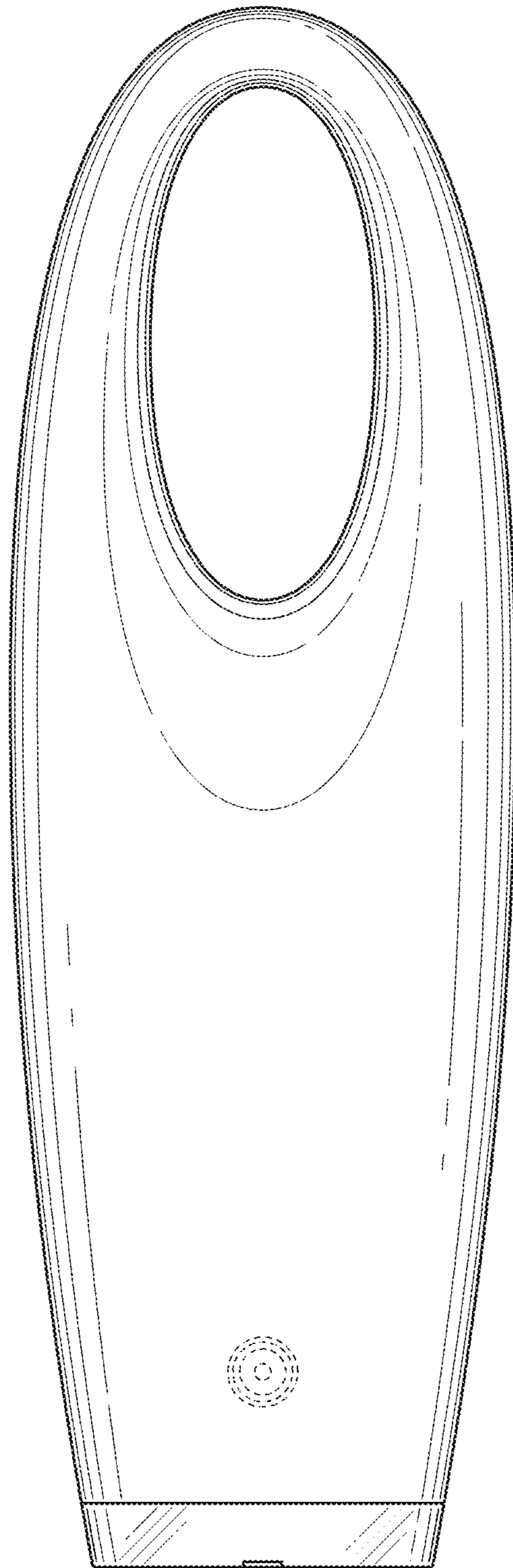

FIG. 3

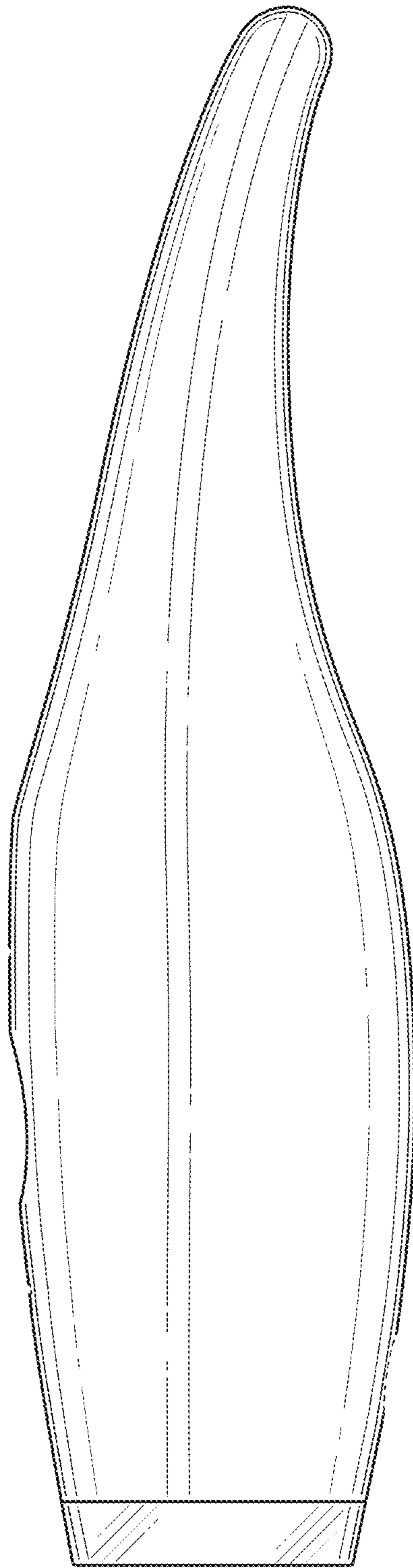

FIG. 4

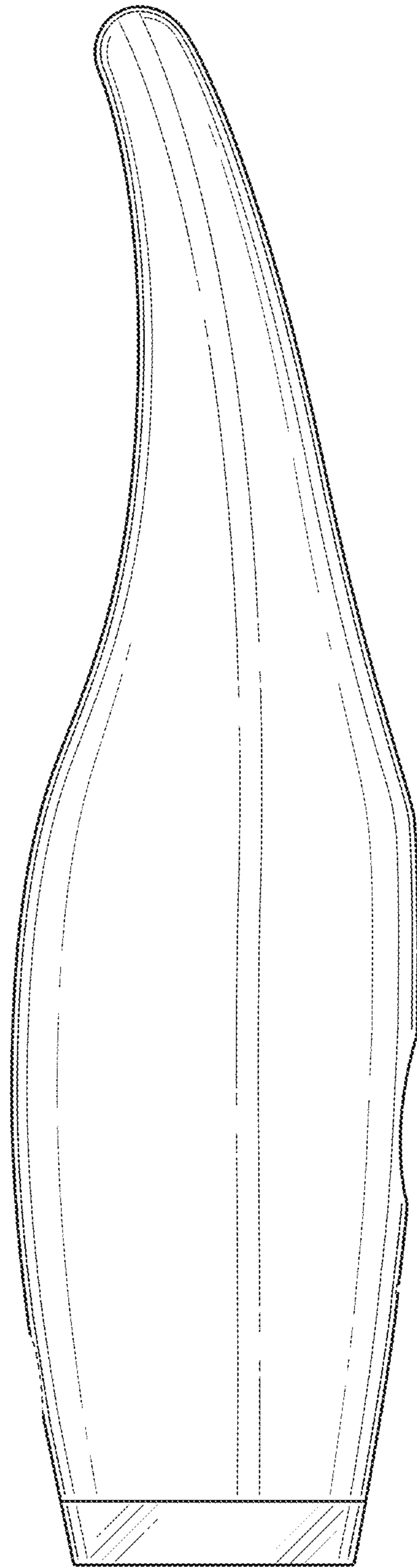

FIG. 5

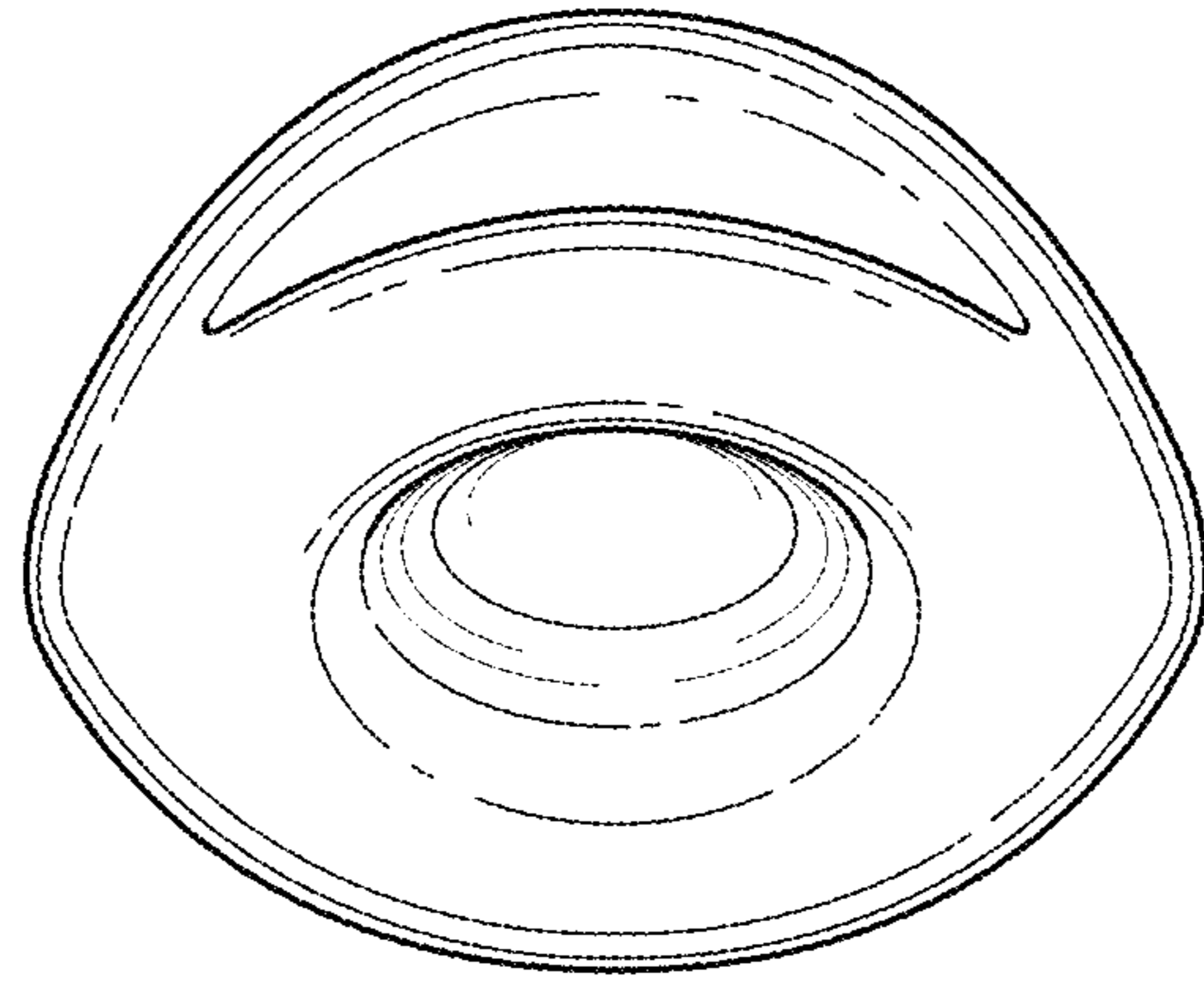

FIG. 6

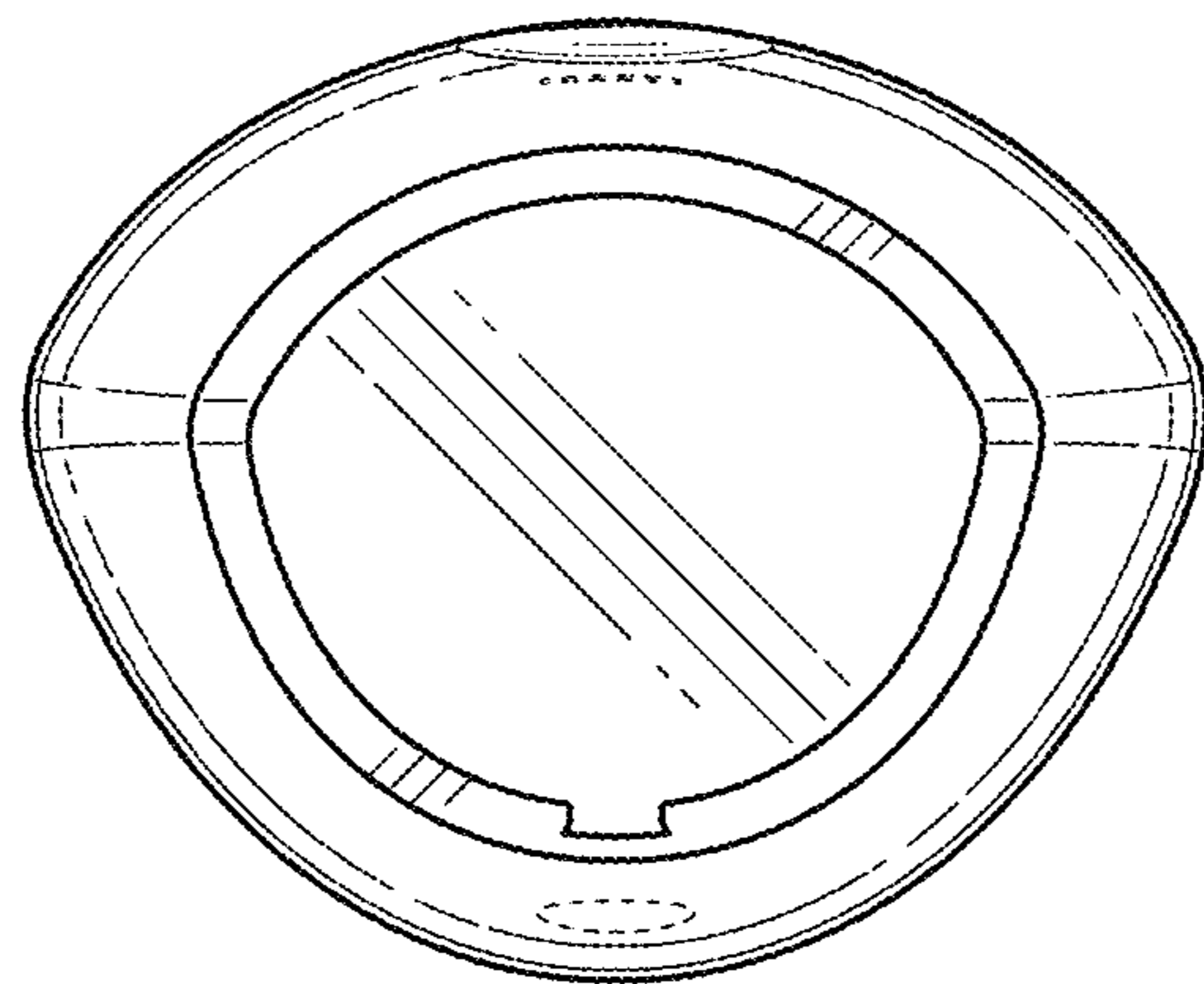

FIG. 7

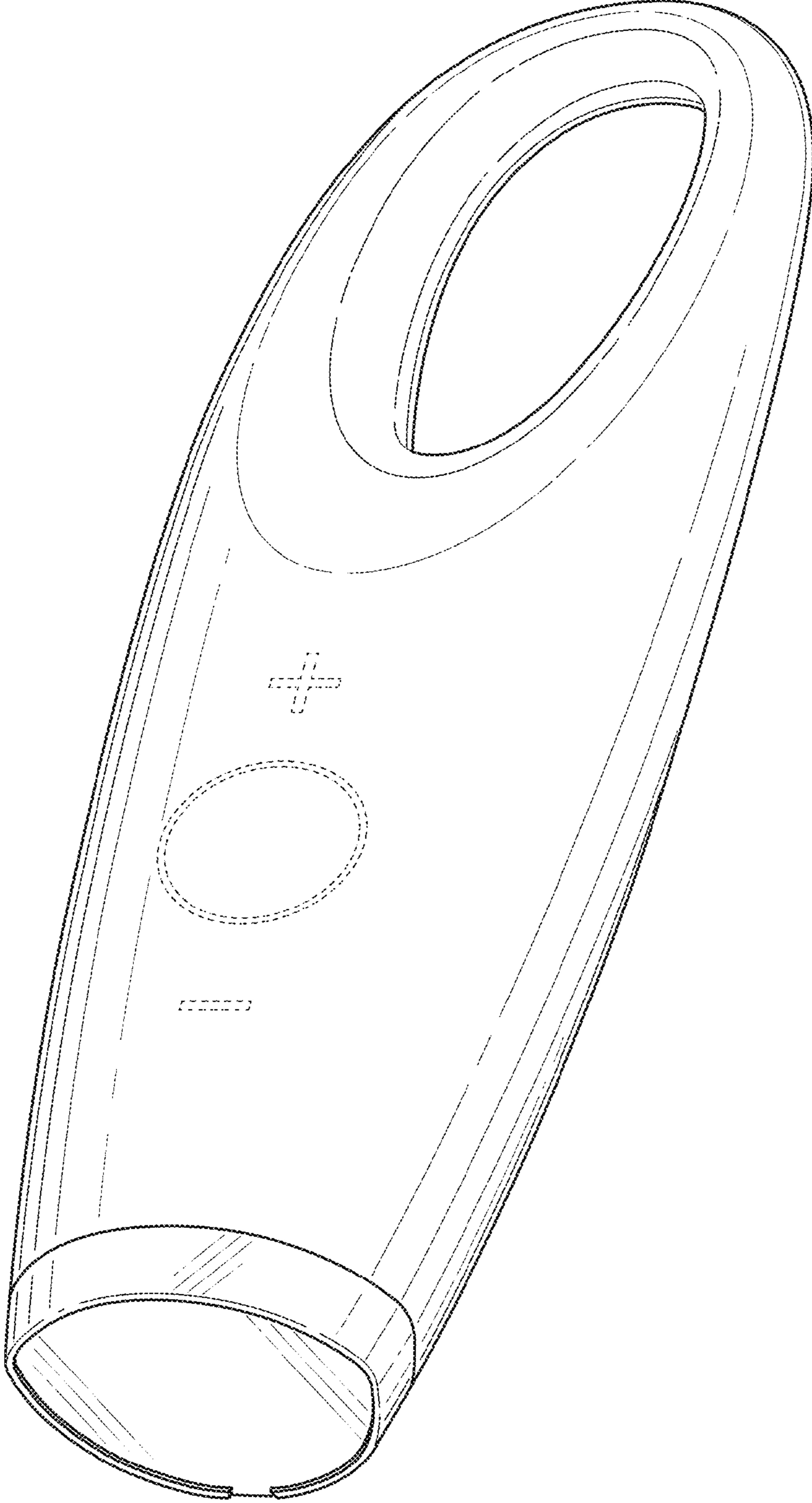

FIG. 8

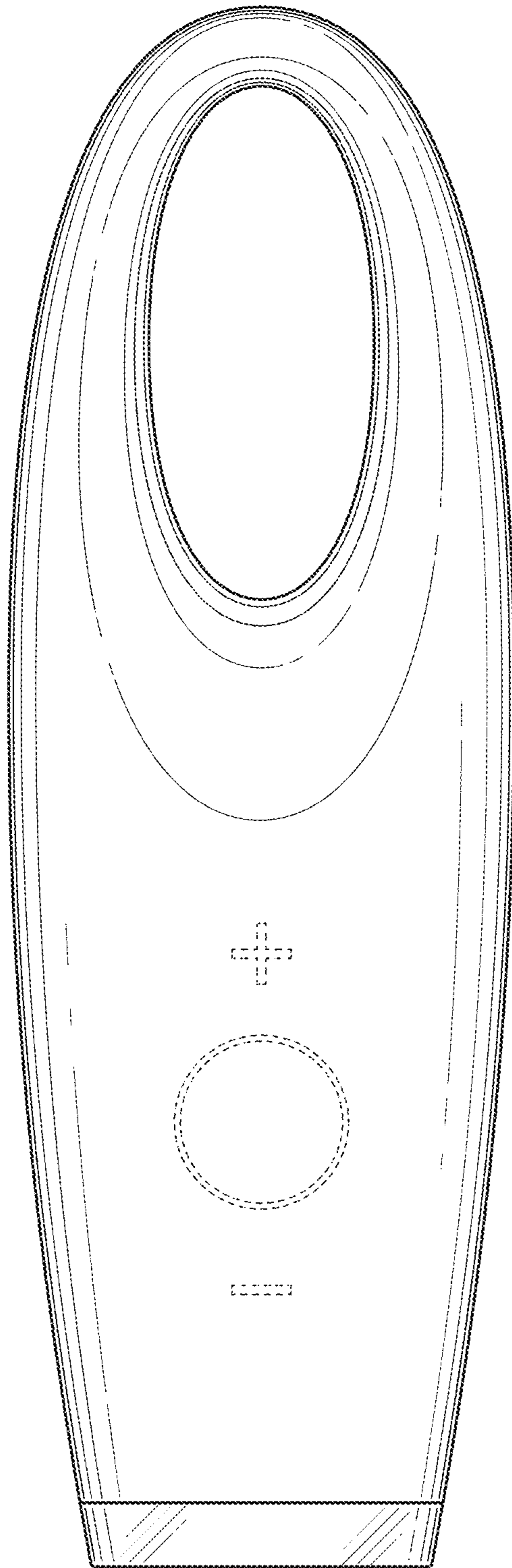

FIG. 9

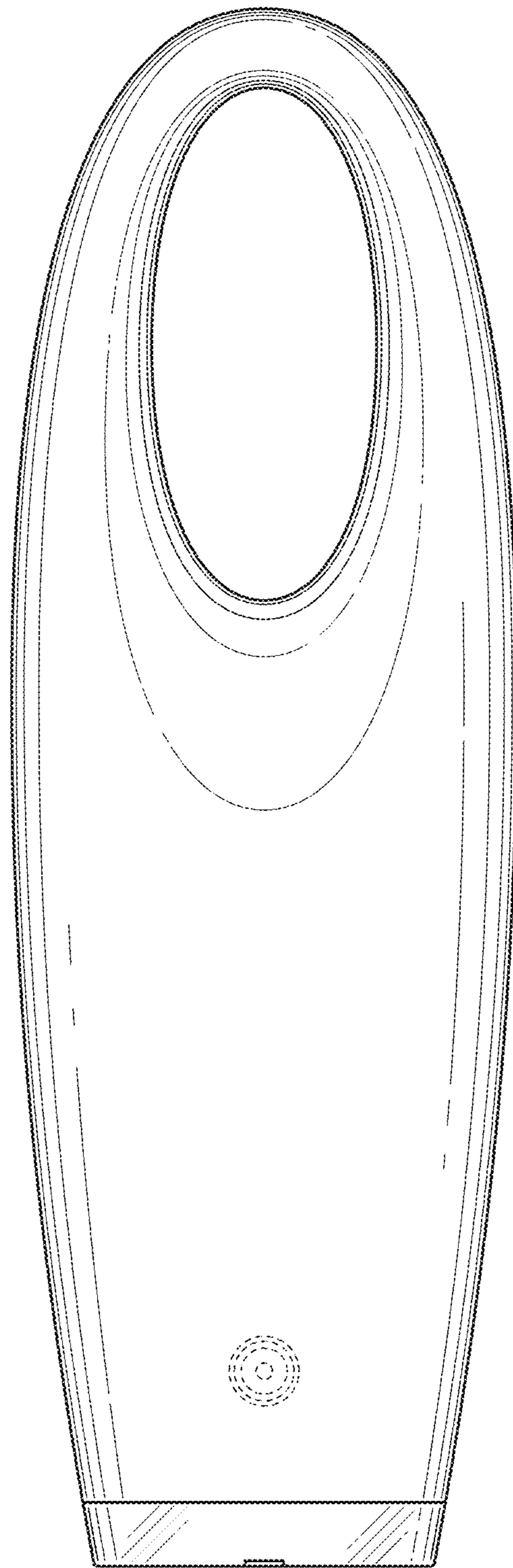

FIG. 10

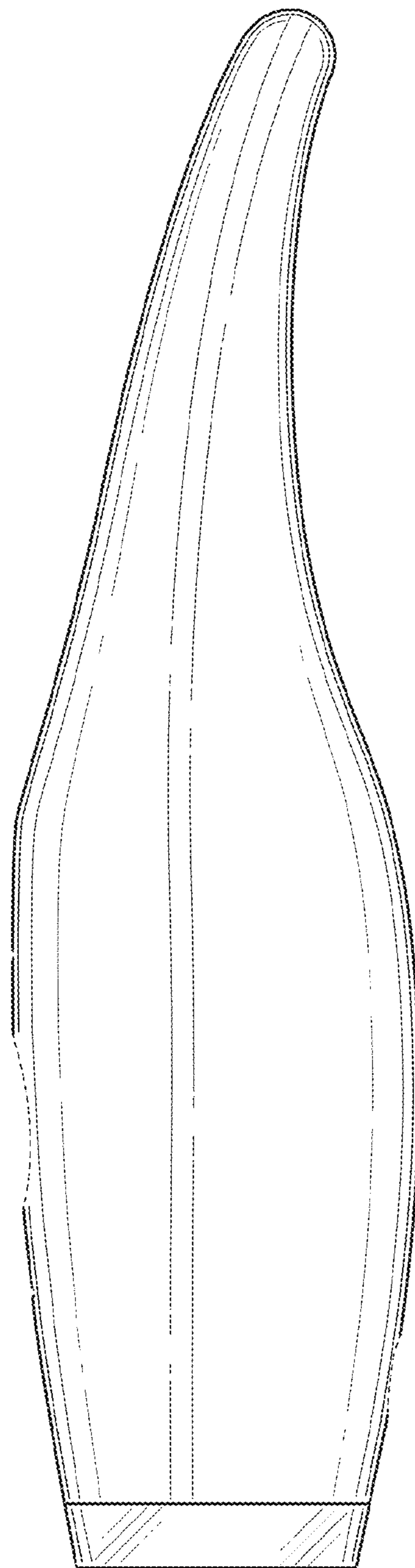

FIG. 11

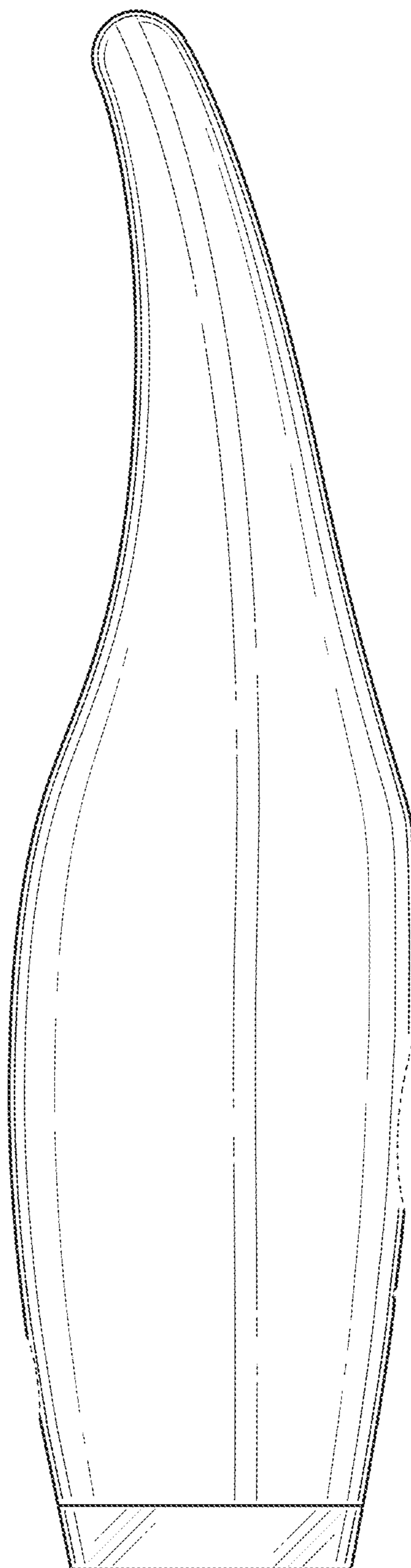

FIG. 12

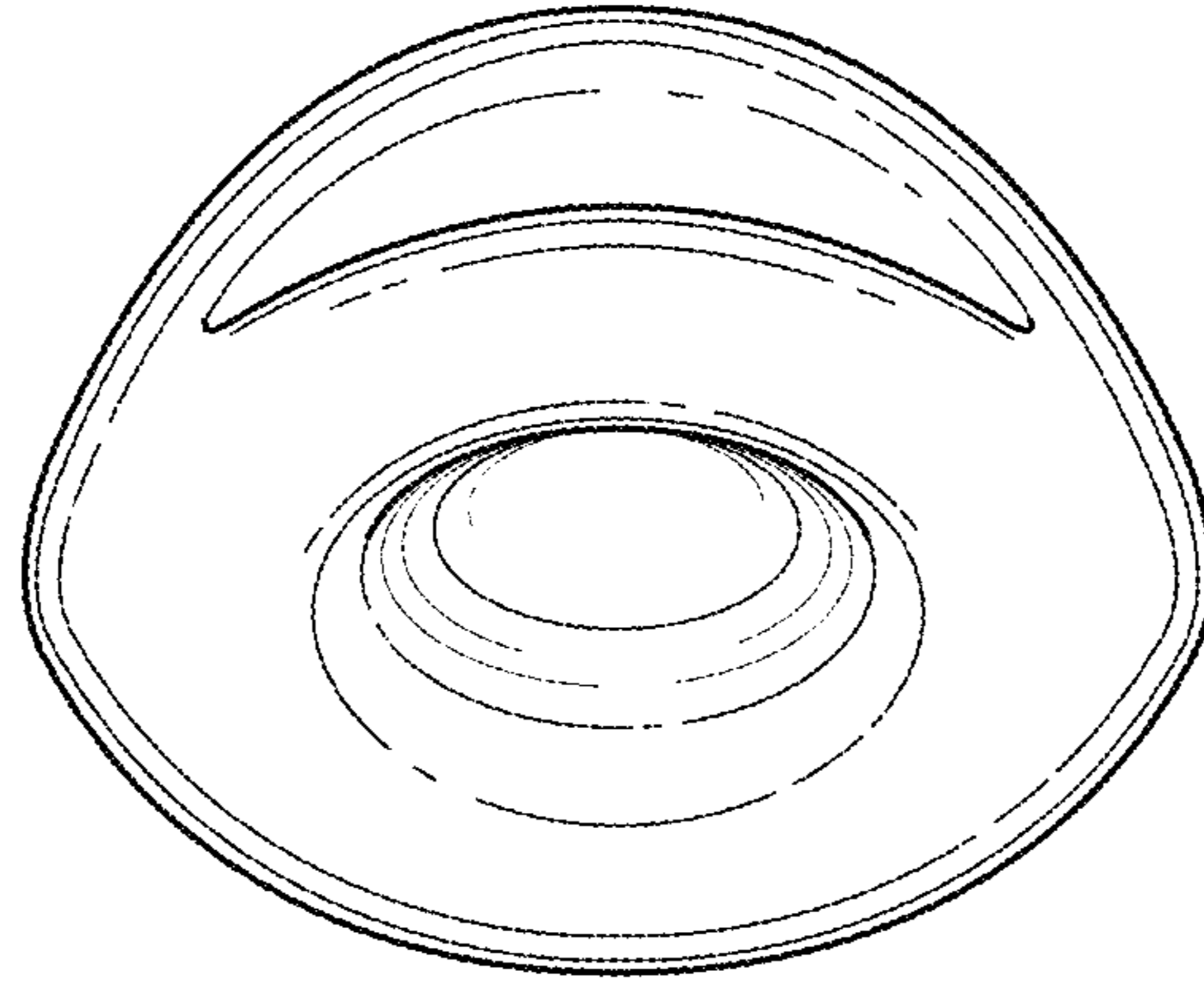

FIG. 13

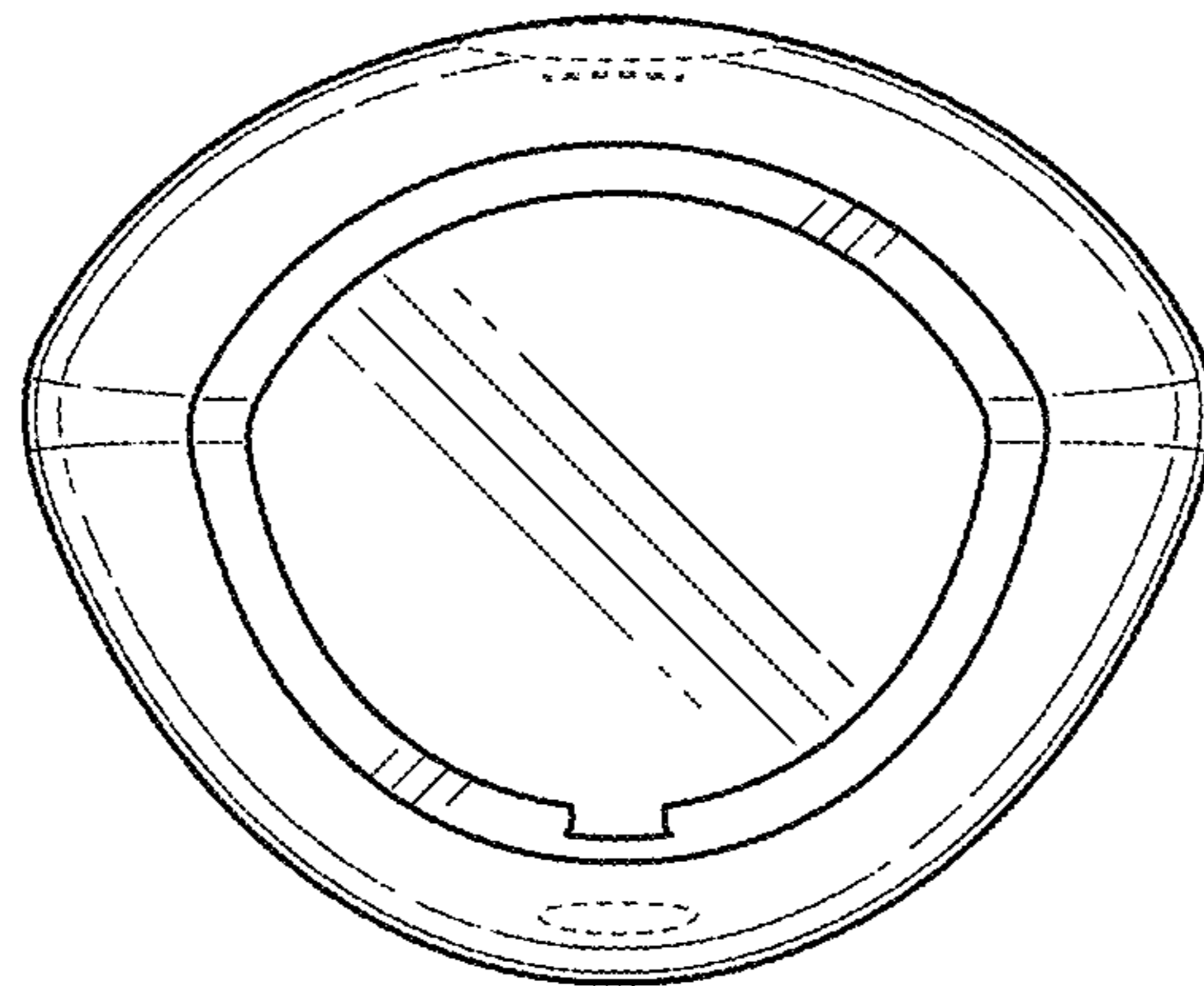

FIG. 14