



US00D765845S

(12) **United States Design Patent** (10) **Patent No.:** **US D765,845 S**
Prybyla et al. (45) **Date of Patent:** **** Sep. 6, 2016**

- (54) **ACETABULAR CUP**
- (71) Applicant: **Total Joint Orthopedics, Inc.**, Salt Lake City, UT (US)
- (72) Inventors: **Robert G. Prybyla**, Round Rock, TX (US); **Benjamin C. Casey**, Salt Lake City, UT (US)
- (73) Assignee: **Joint Development, LLC**, Salt Lake City, UT (US)
- (**) Term: **14 Years**
- (21) Appl. No.: **29/507,101**
- (22) Filed: **Oct. 23, 2014**

- 5,156,627 A 10/1992 Amstutz et al.
- 5,376,126 A * 12/1994 Lin A61B 17/746
606/60
- 5,437,675 A 8/1995 Wilson
- 6,146,423 A * 11/2000 Cohen A61F 2/3877
623/20.2
- 6,652,591 B2 11/2003 Serbousek et al.
- 7,678,150 B2 * 3/2010 Tornier A61F 2/40
623/19.13
- 7,785,371 B2 * 8/2010 Collazo A61F 2/4014
623/19.11
- D643,926 S * 8/2011 Collins D24/155
- 8,246,687 B2 * 8/2012 Katrana A61F 2/4014
623/19.13
- 8,303,665 B2 * 11/2012 Tornier A61F 2/4081
623/19.11
- D719,261 S * 12/2014 Skvaro D24/155
- 2003/0028253 A1 * 2/2003 Stone A61F 2/4014
623/19.14

Related U.S. Application Data

- (60) Continuation of application No. 14/292,723, filed on May 30, 2014, which is a continuation of application No. 14/024,146, filed on Sep. 11, 2013, now abandoned, which is a division of application No. 13/442,222, filed on Apr. 9, 2012, now abandoned.
- (51) **LOC (10) Cl.** **24-02**
- (52) **U.S. Cl.**
USPC **D24/155**
- (58) **Field of Classification Search**
USPC D24/155, 156
CPC A61F 2/36; A61F 2/3662; A61F 2/30767;
A61F 2/34; A61F 2002/3631; A61F
2002/30332; A61F 2002/365; A61F
2002/30507; A61F 2310/00029
See application file for complete search history.

References Cited

U.S. PATENT DOCUMENTS

- 4,454,612 A 6/1984 McDaniel et al.
- 4,676,798 A 6/1987 Noiles
- 4,711,233 A * 12/1987 Brown A61B 17/8802
606/81
- 4,865,604 A * 9/1989 Rogozinski A61F 2/32
606/60

* cited by examiner

Primary Examiner — Charles Hanson

(74) *Attorney, Agent, or Firm* — Lowry Blixseth LLP; Scott M. Lowry

(57) **CLAIM**

The ornamental design for an acetabular cup, as shown and described.

DESCRIPTION

FIG. 1 is a perspective view showing the front, bottom and left sides of the acetabular cup;
 FIG. 2 is a front elevation view of the acetabular cup;
 FIG. 3 is a left side elevation view of the acetabular cup;
 FIG. 4 is a right side elevation view of the acetabular cup;
 FIG. 5 is a rear elevation view of the acetabular cup;
 FIG. 6 is a top plan view of the acetabular cup;
 FIG. 7 is a bottom plan view of the acetabular cup; and,
 FIG. 8 is a perspective view showing the rear, top and left sides of the acetabular cup.
 The broken line showing is included for the purpose of depicting environmental subject matter and forms no part of the claimed design. The stippled shading indicates a contrast in appearance.

1 Claim, 8 Drawing Sheets

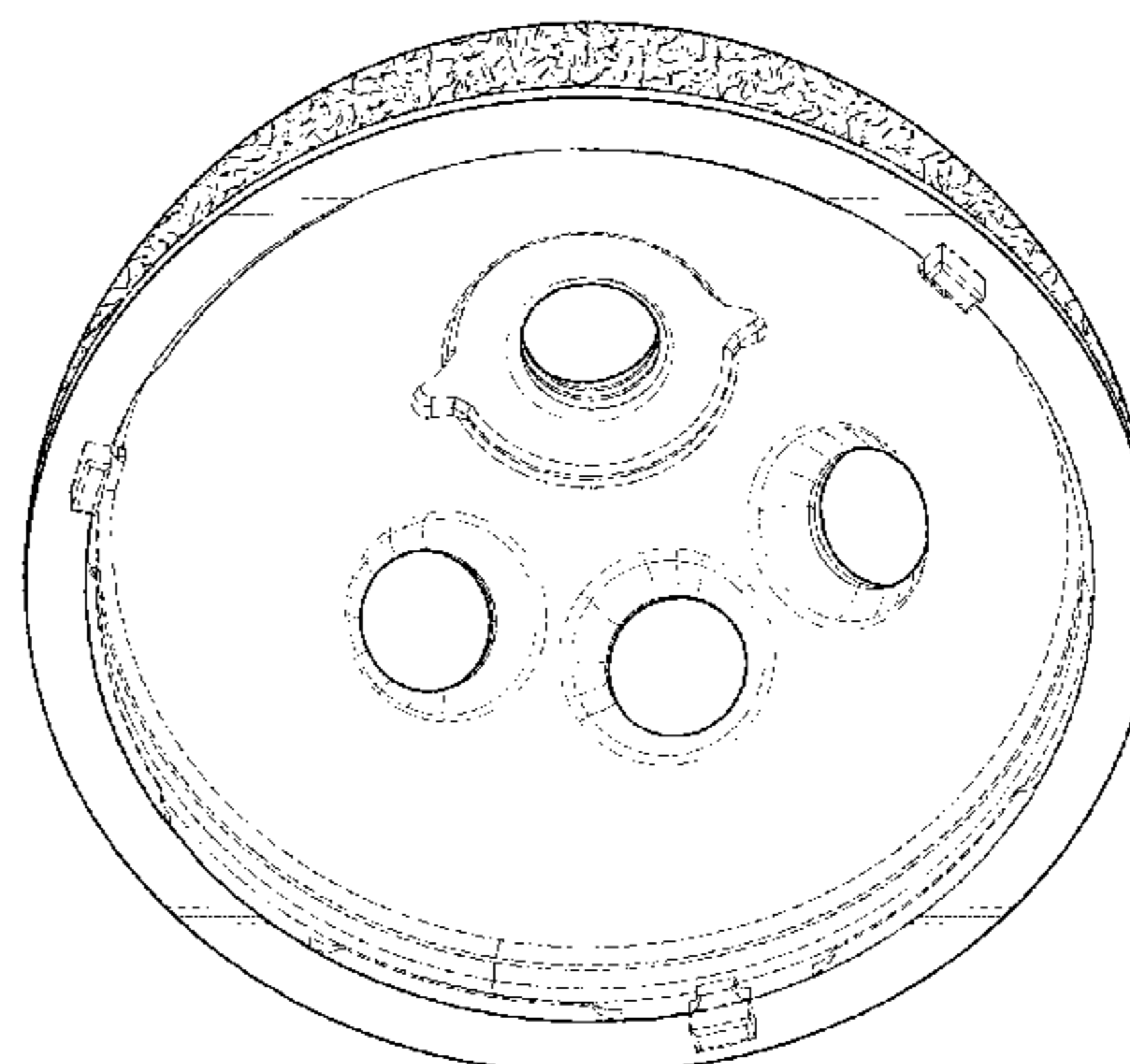
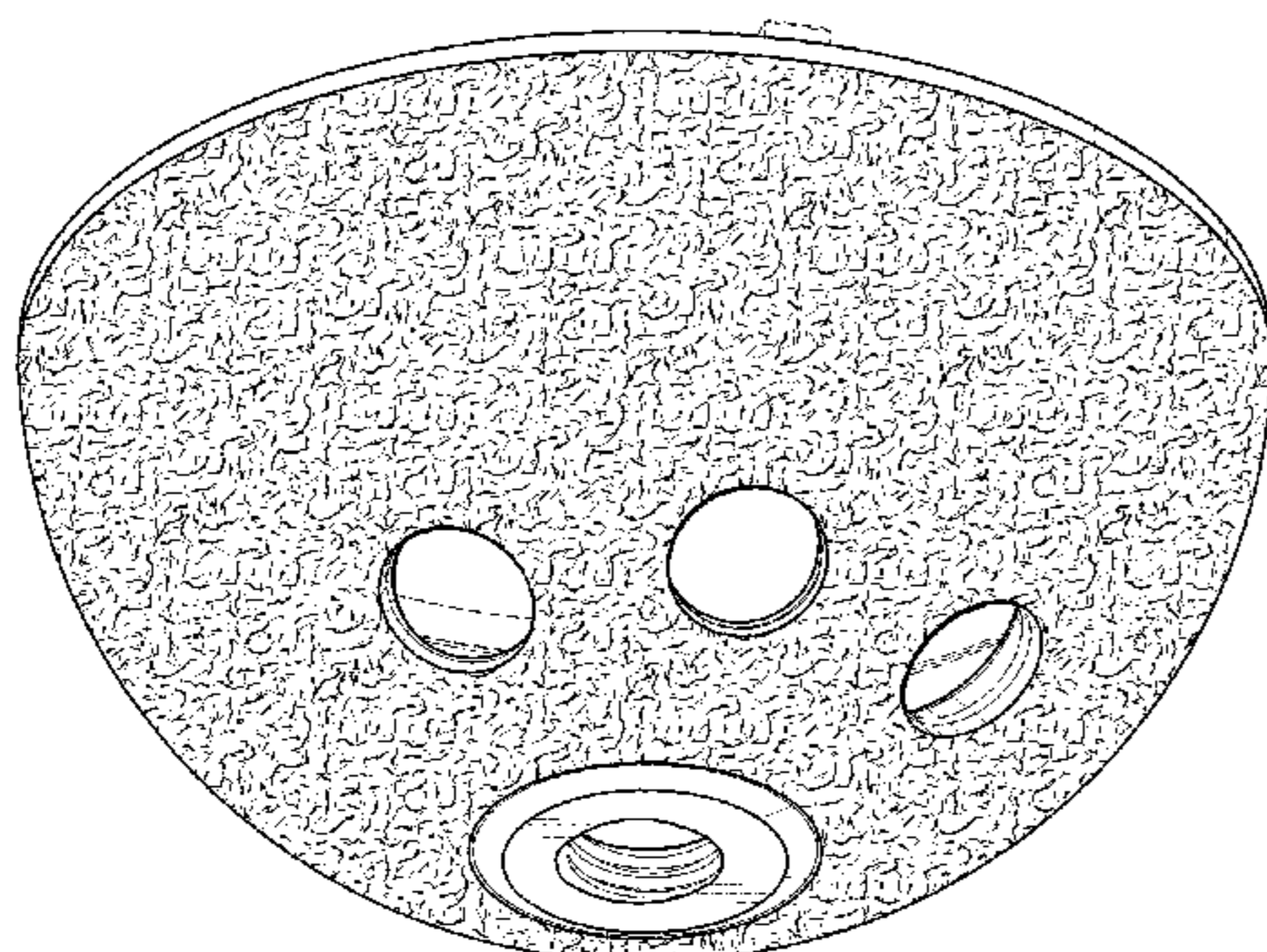

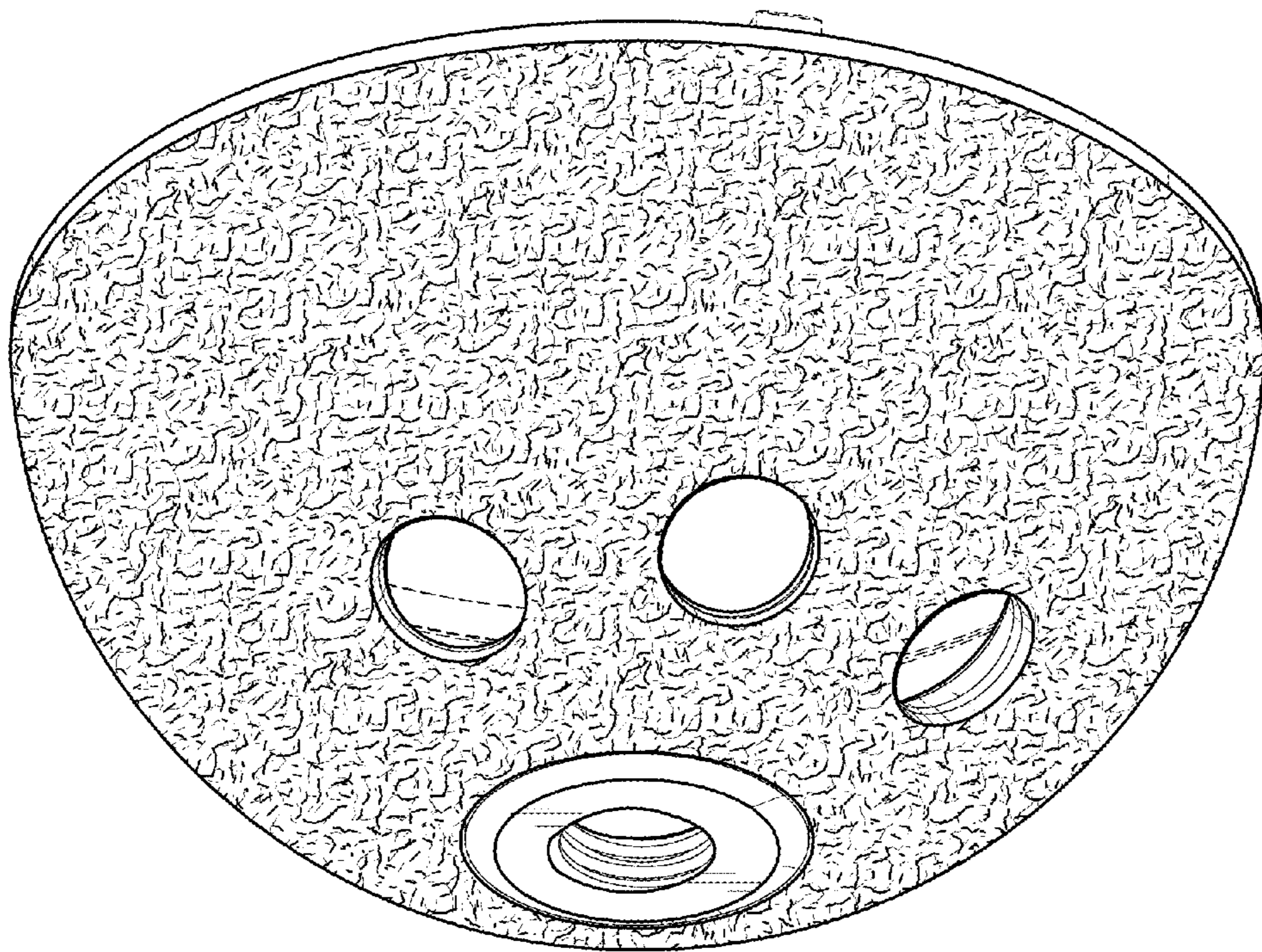

FIG. 1

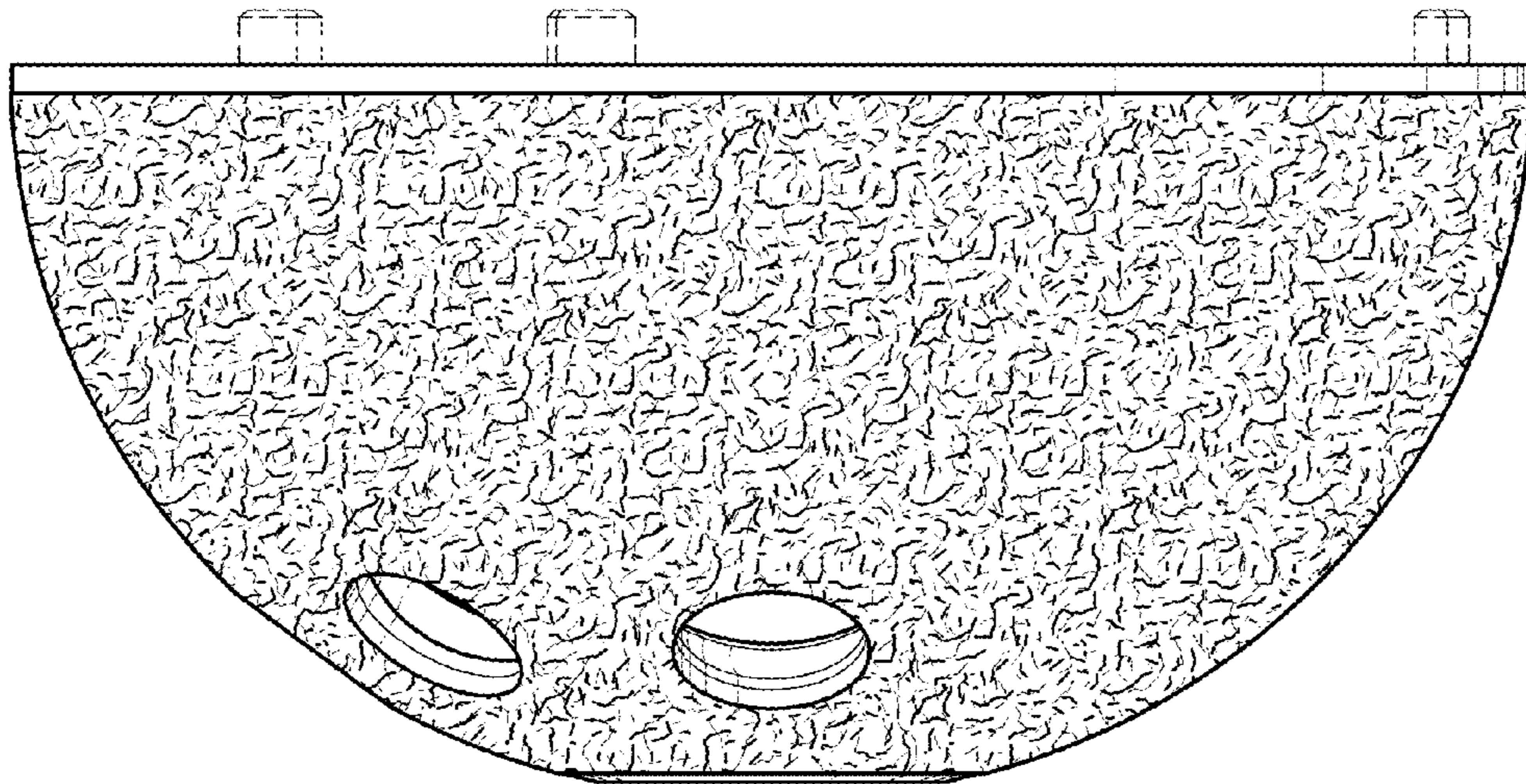

FIG. 2

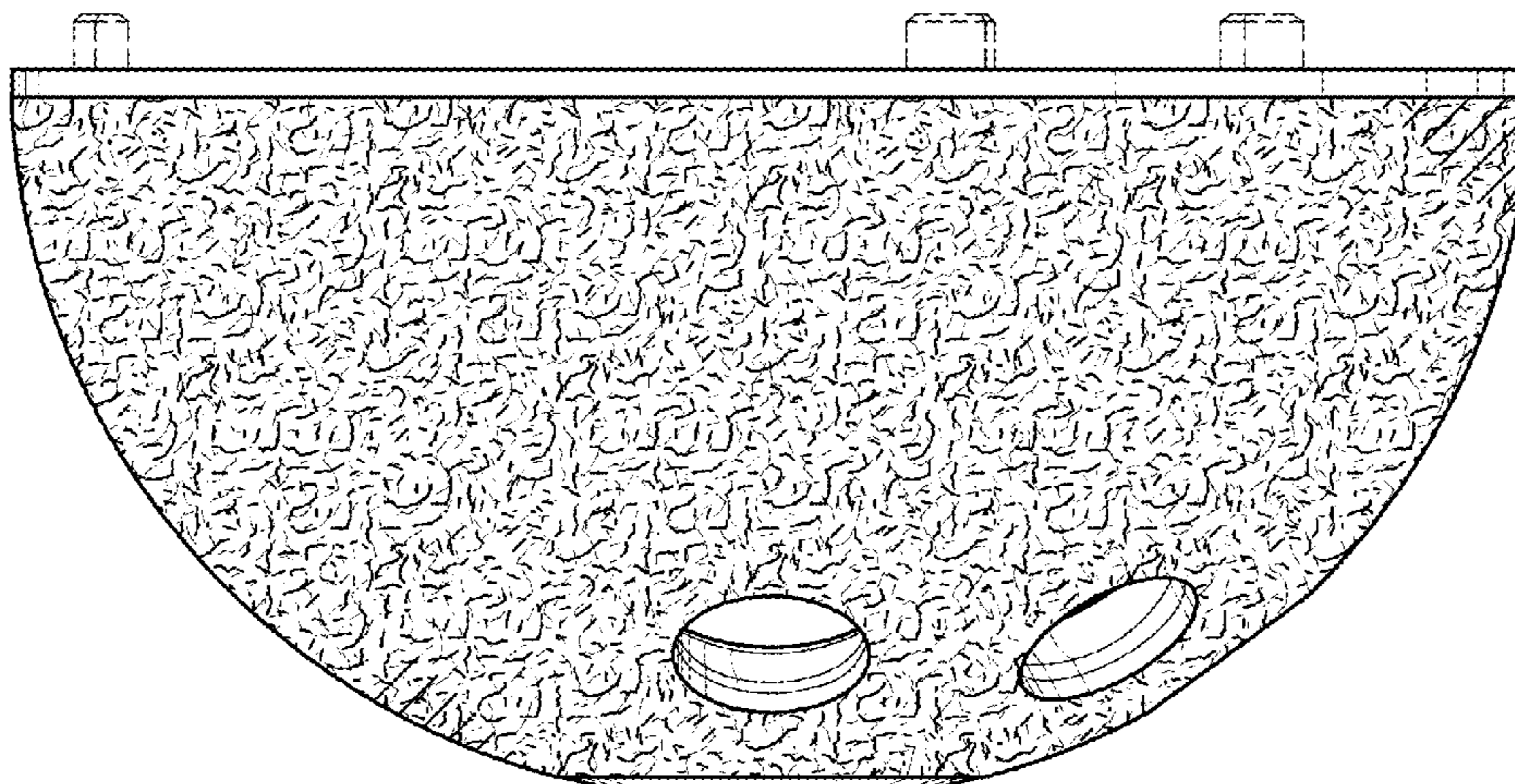

FIG. 3

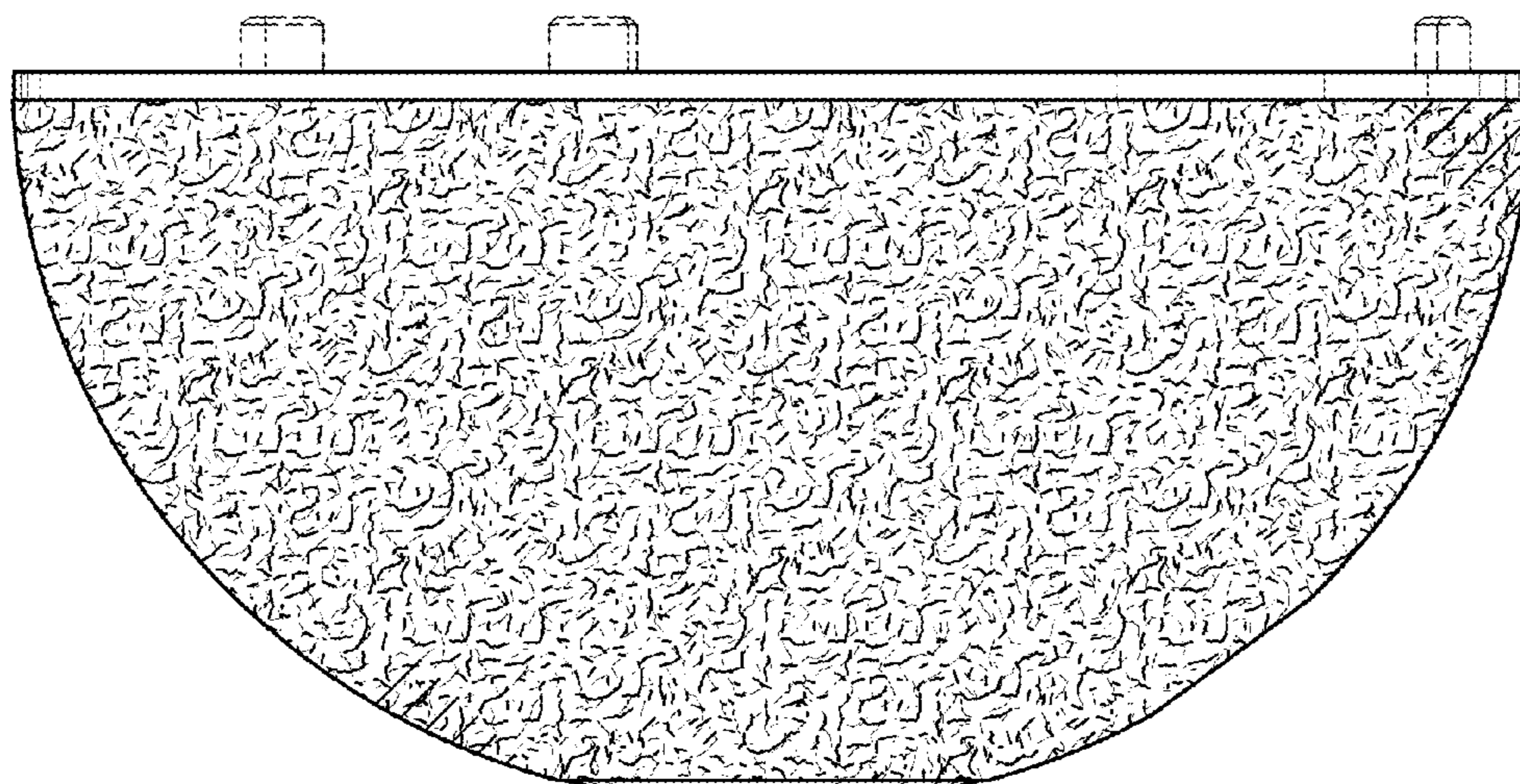

FIG. 4

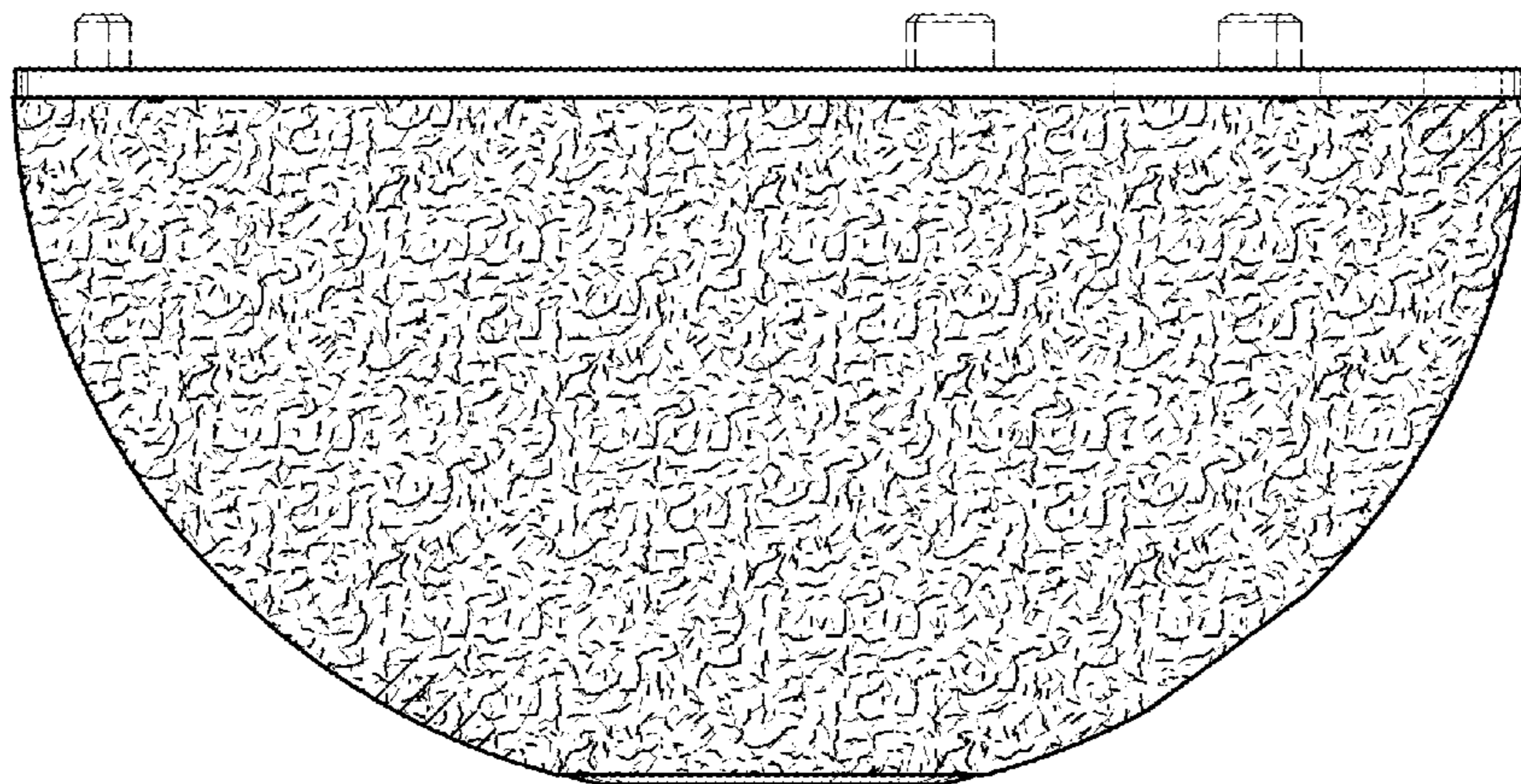

FIG. 5

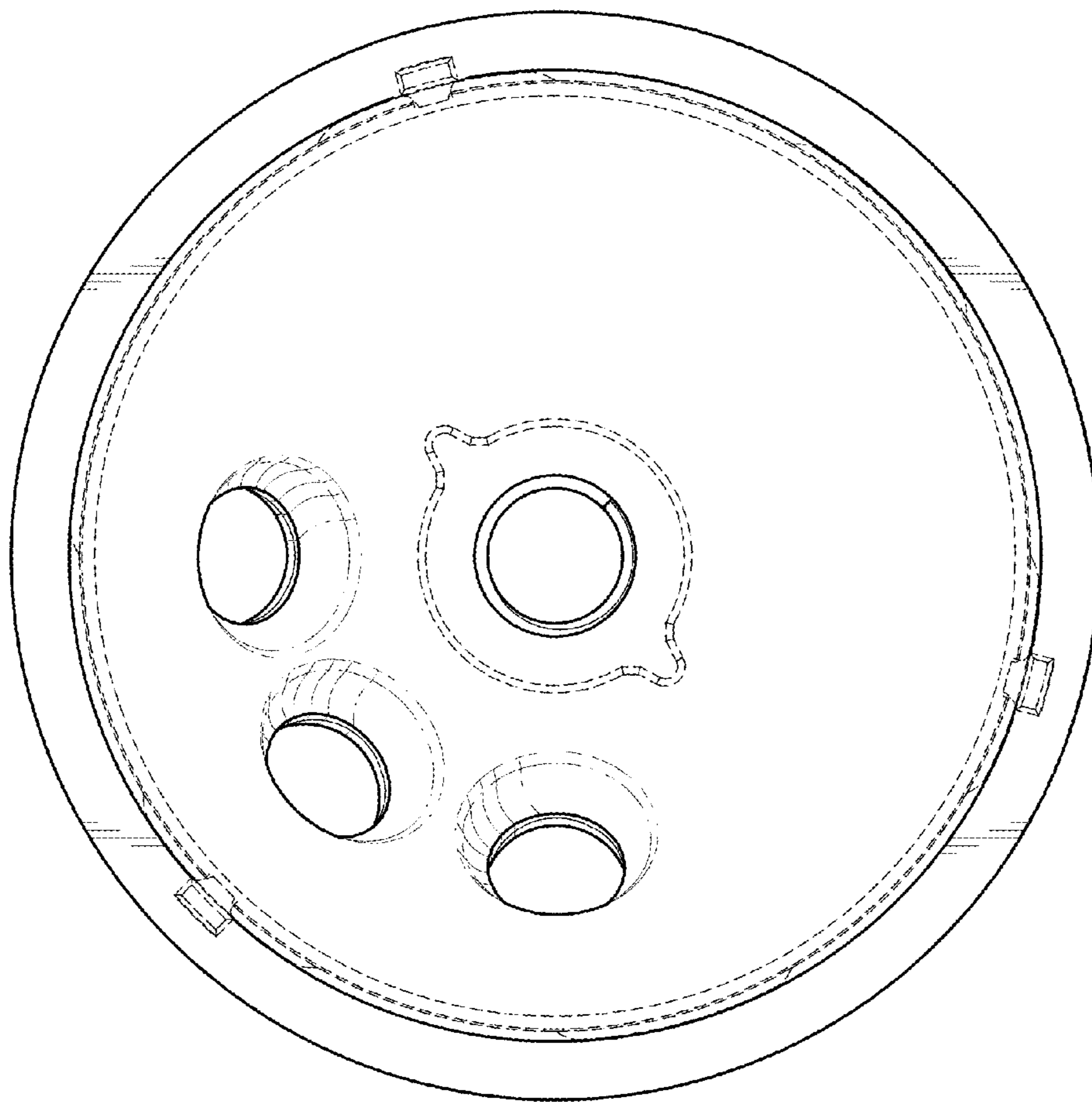

FIG. 6

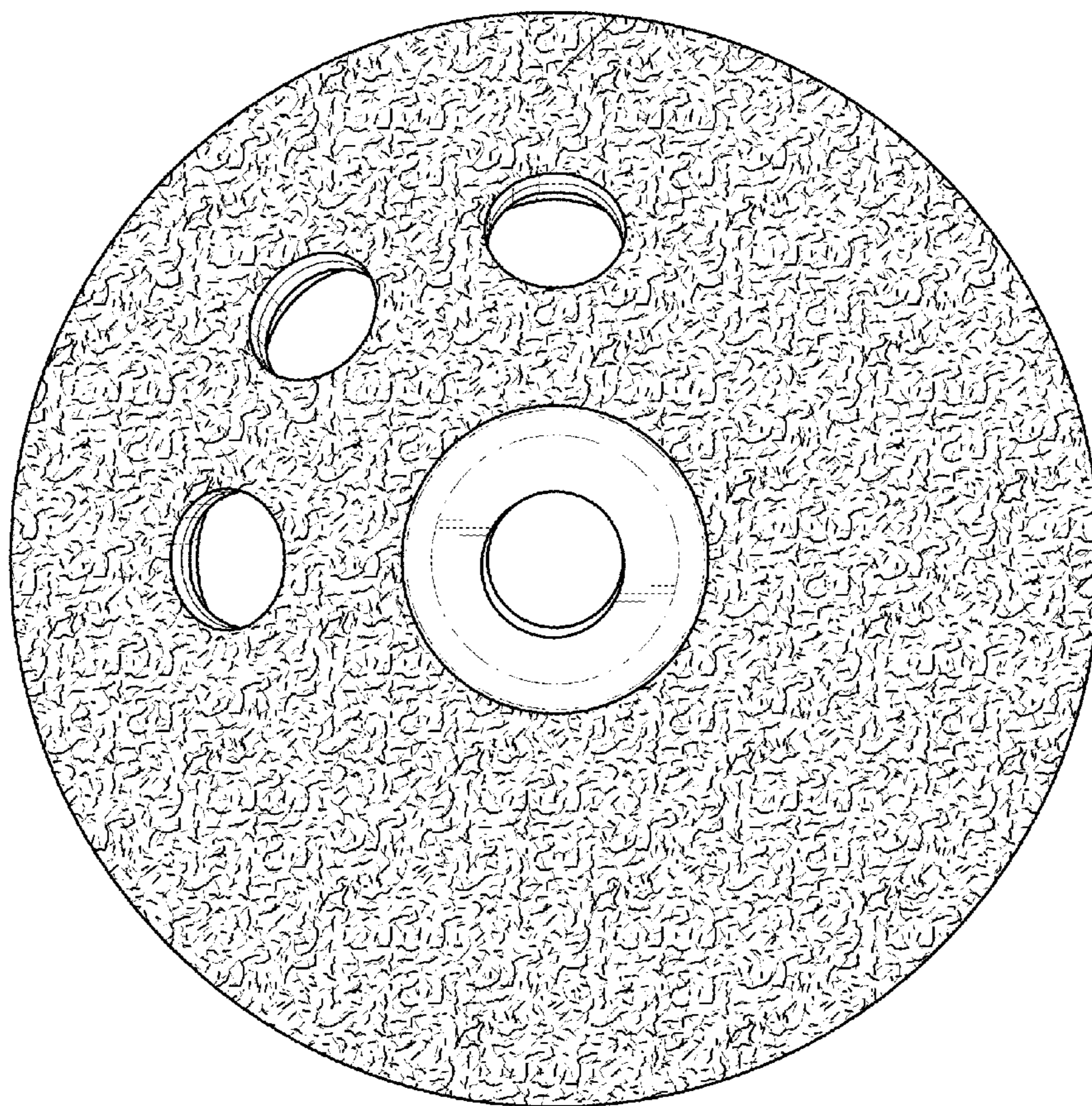

FIG. 7

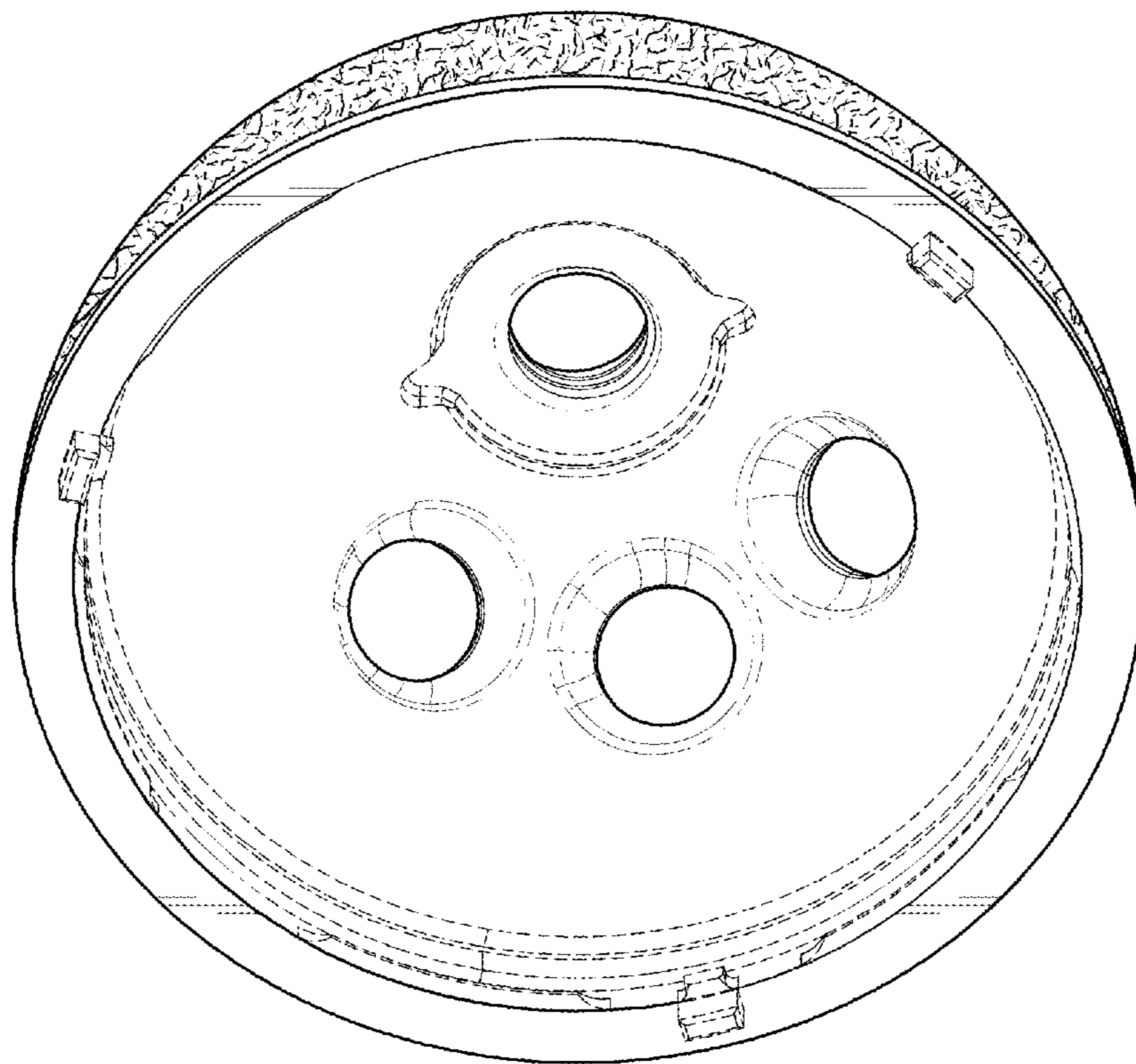

FIG. 8