



US00D765616S

(12) **United States Design Patent** (10) **Patent No.:** **US D765,616 S**
Corval (45) **Date of Patent:** **** Sep. 6, 2016**

(54) **PORTABLE SPEAKER**

(56) **References Cited**

(71) Applicant: **Ningbo Prosound Electronics Co., Ltd.**, Fenghua, Zhejiang (CN)

U.S. PATENT DOCUMENTS

(72) Inventor: **Alexis Corval**, Zhejiang (CN)

D401,932 S *	12/1998	Deguchi	D14/165
D516,578 S *	3/2006	Matsuoka	D14/160
D535,281 S *	1/2007	Yang	D14/203.3
D538,783 S *	3/2007	Lee	D14/188
D542,272 S *	5/2007	Shiono	D14/214
D612,868 S *	3/2010	Morabito	D14/496
D643,401 S *	8/2011	Chen	D14/203.3
D690,281 S *	9/2013	Carr	D14/204

(73) Assignee: **Ningbo Prosound Electronics Co., Ltd.** (CN)

(**) Term: **14 Years**

* cited by examiner

(21) Appl. No.: **29/525,899**

Primary Examiner — Derrick Holland
Assistant Examiner — Janice Lim

(22) Filed: **May 4, 2015**

(51) **LOC (10) Cl.** **14-01**

(57) **CLAIM**

The ornamental design for a portable speaker, as shown and described.

(52) **U.S. Cl.**

USPC **D14/204**

DESCRIPTION

(58) **Field of Classification Search**

USPC D14/167, 168, 170–172, 188, 203.1, D14/203.3, 204, 209.1, 210–216, 219, 221, D14/222, 224; 181/144, 148, 153, 157, 198; 369/6–12; 381/301–303, 306, 332, 381/334, 336, 345, 361–363, 386–388
 CPC G06F 1/1688; H04R 1/02; H04R 1/025; H04R 1/026; H04R 1/323; H04R 1/403; H04R 1/2803; H04R 1/2834; H04R 5/02; H04R 9/06

FIG. 1 is a front perspective view of a portable speaker, showing my new design;
 FIG. 2 is a back perspective view thereof;
 FIG. 3 is a front view thereof;
 FIG. 4 is a back view thereof;
 FIG. 5 is a left side view thereof;
 FIG. 6 is a right side view thereof;
 FIG. 7 is a top plan view thereof; and,
 FIG. 8 is a bottom plan view thereof.

See application file for complete search history.

1 Claim, 8 Drawing Sheets

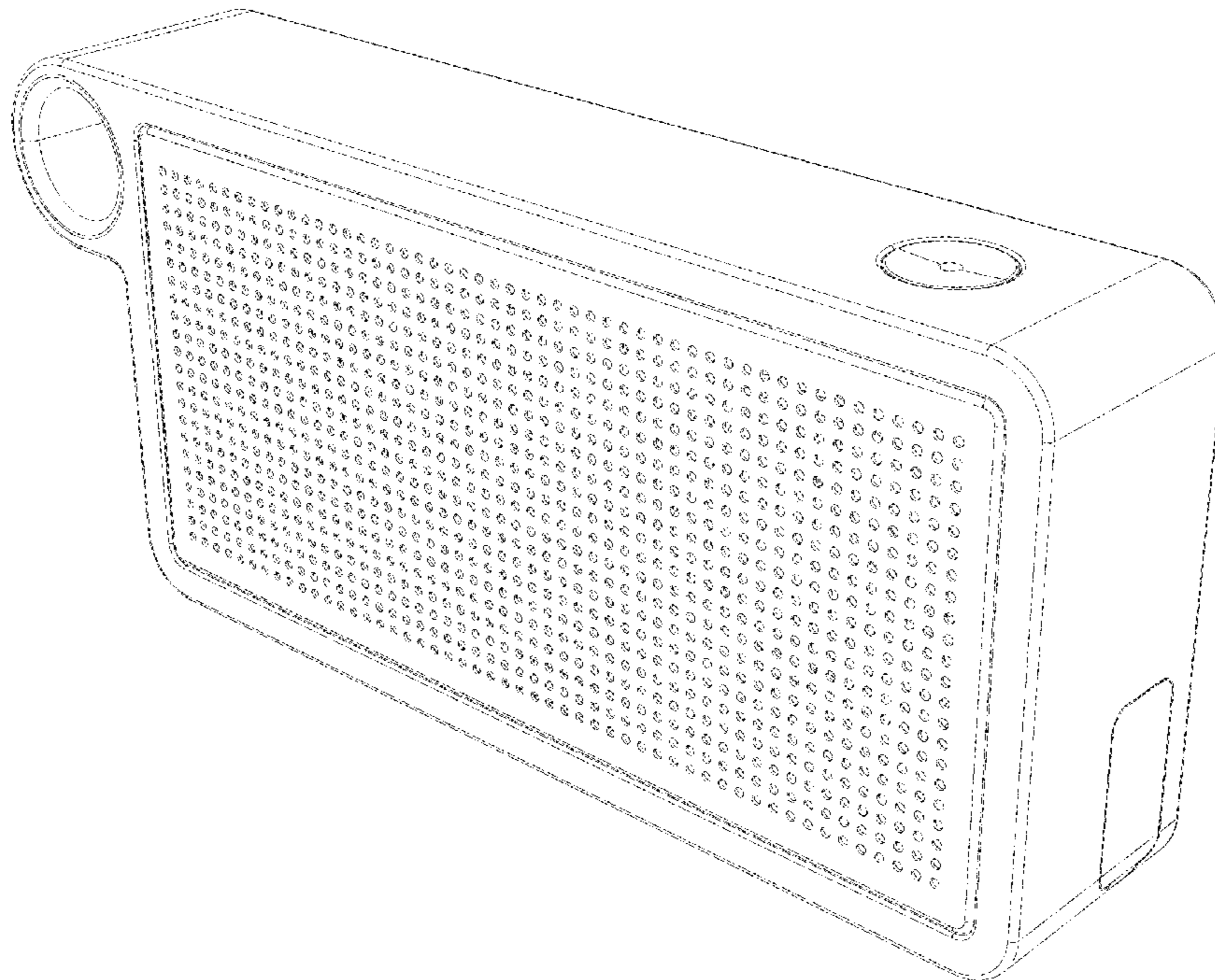

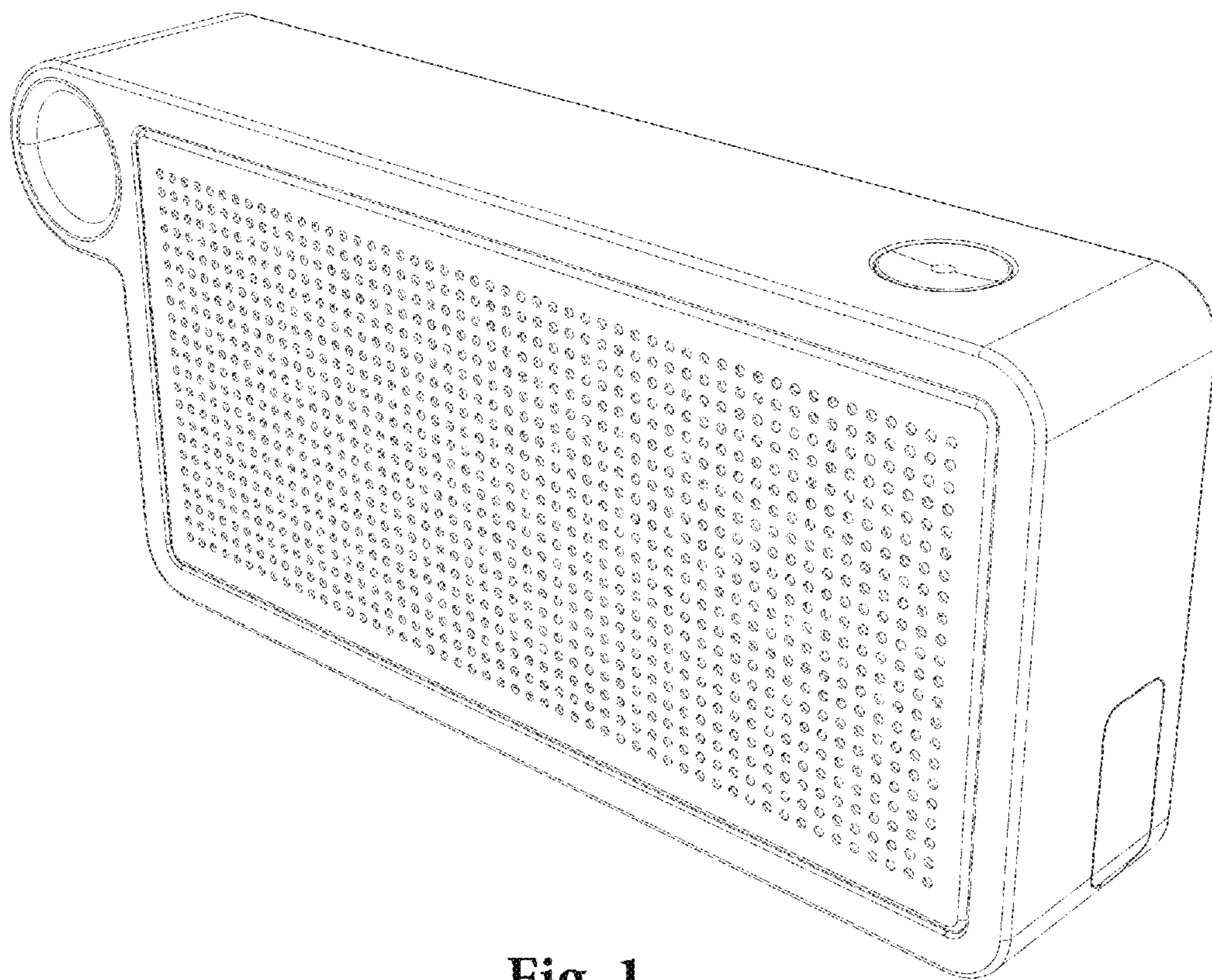

Fig. 1

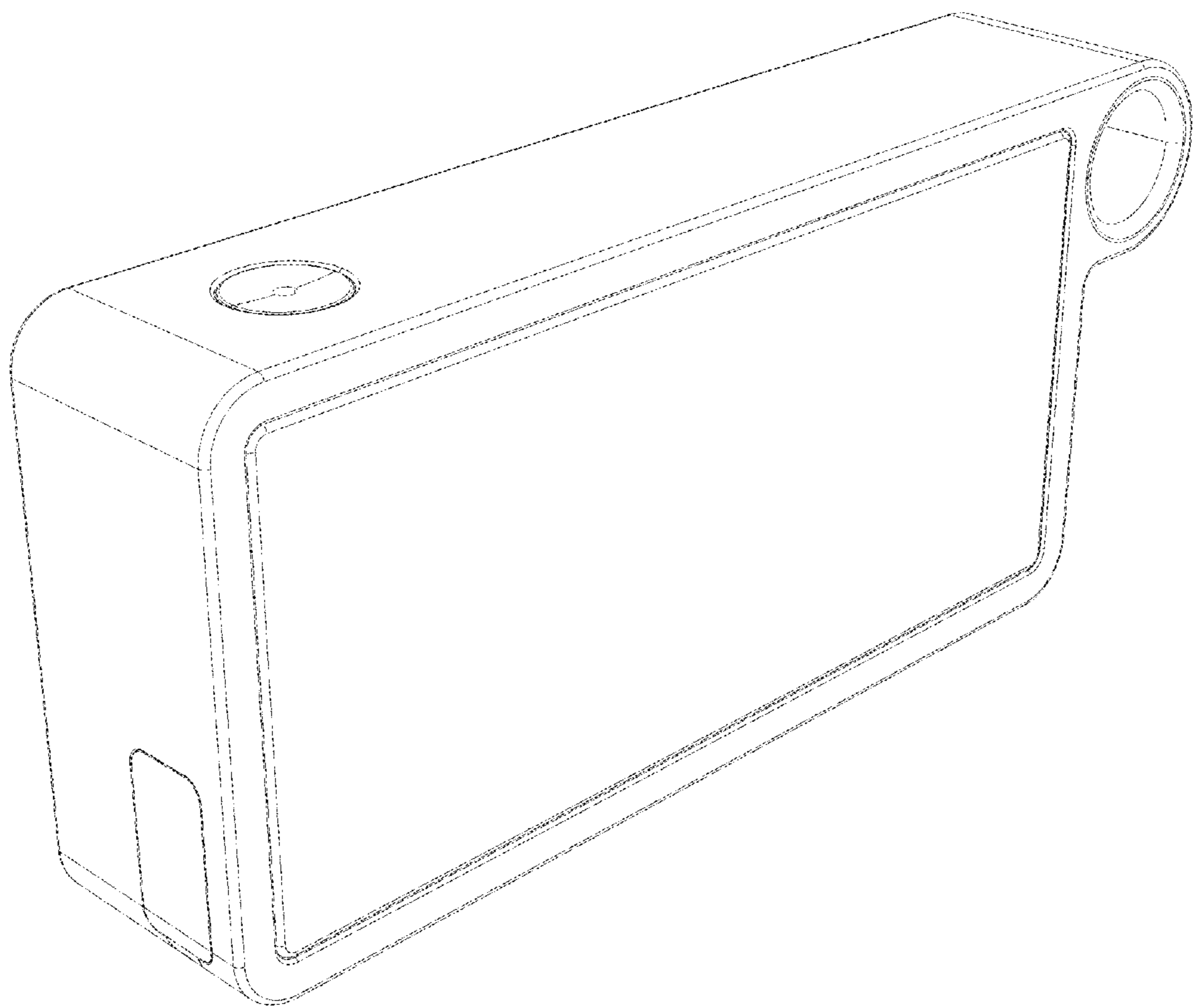

Fig. 2

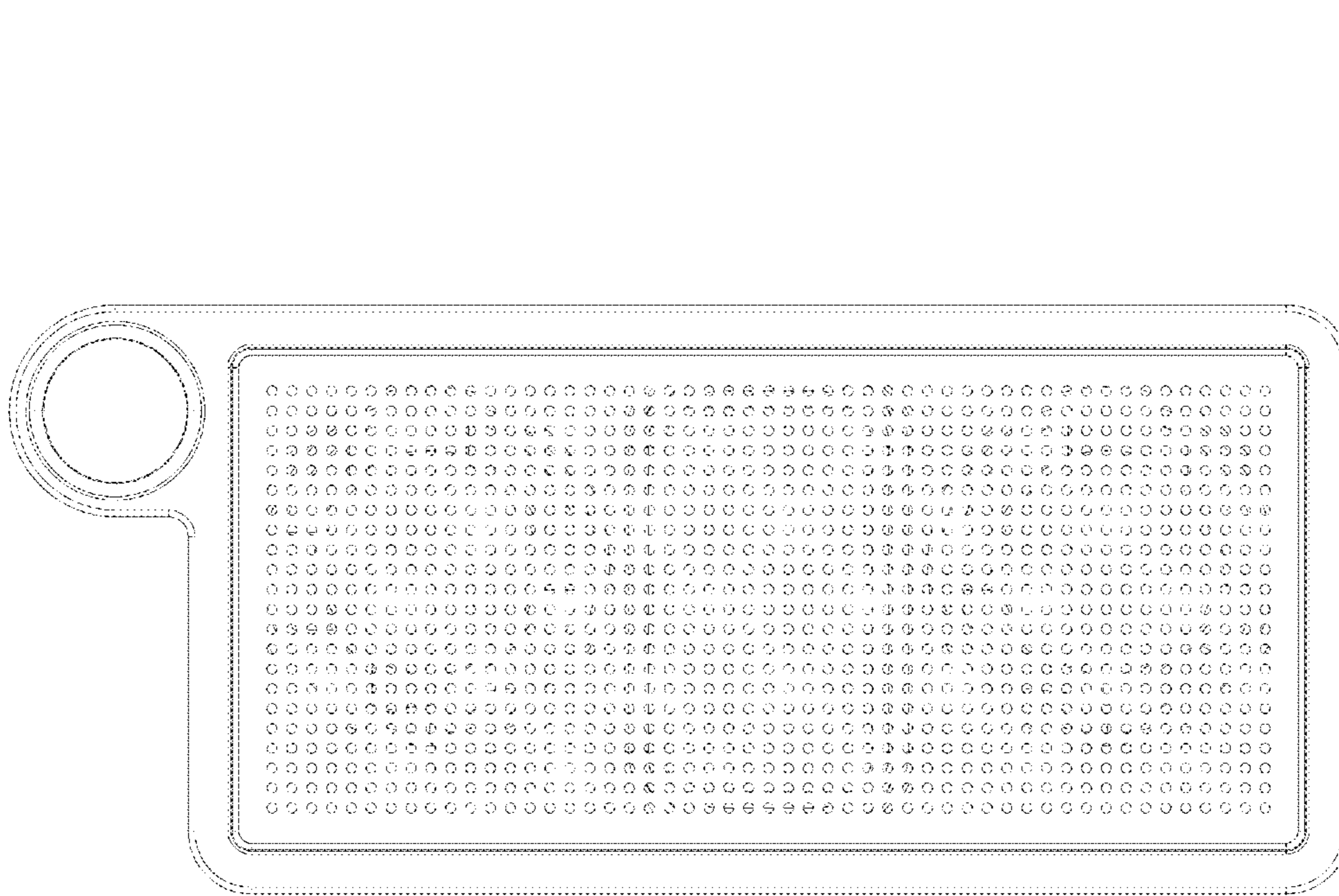

Fig. 3

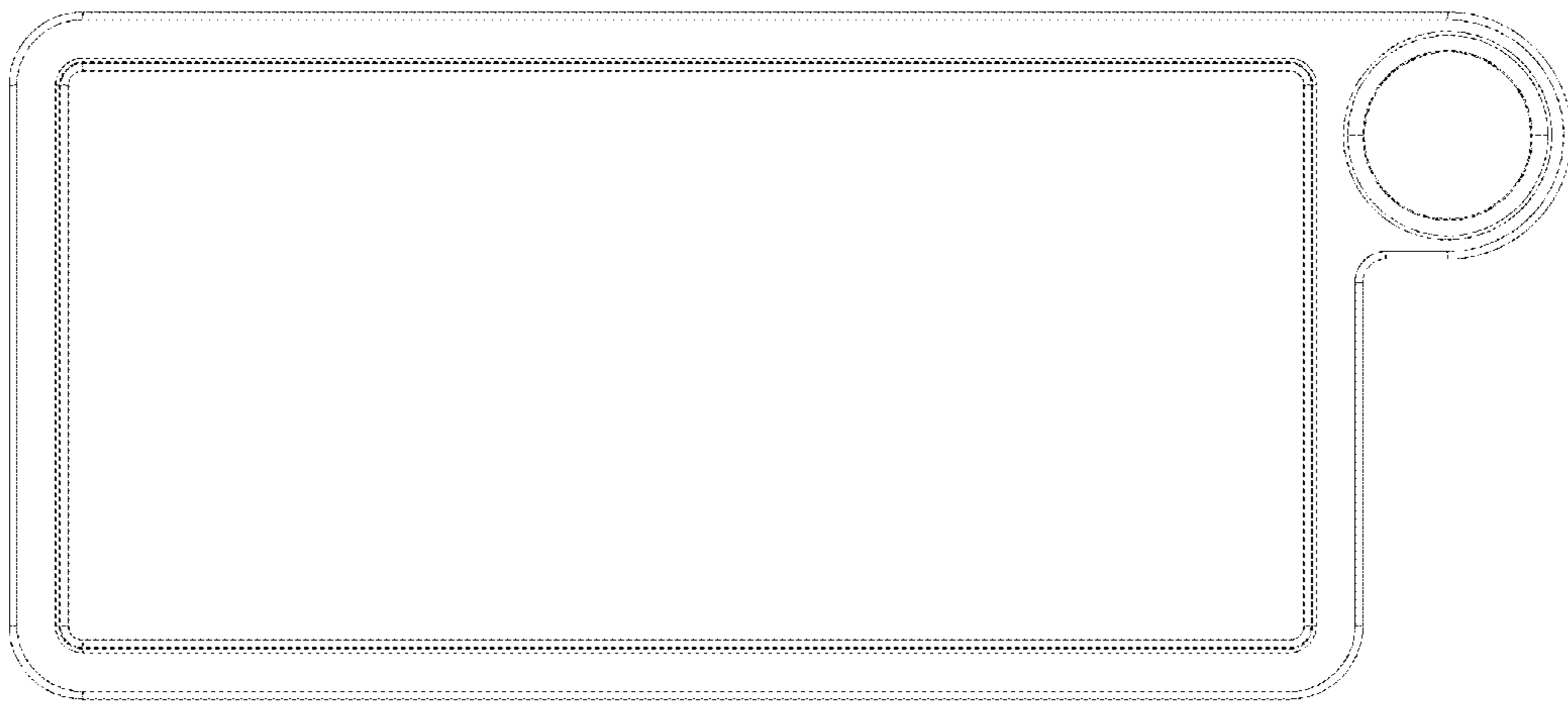

Fig. 4

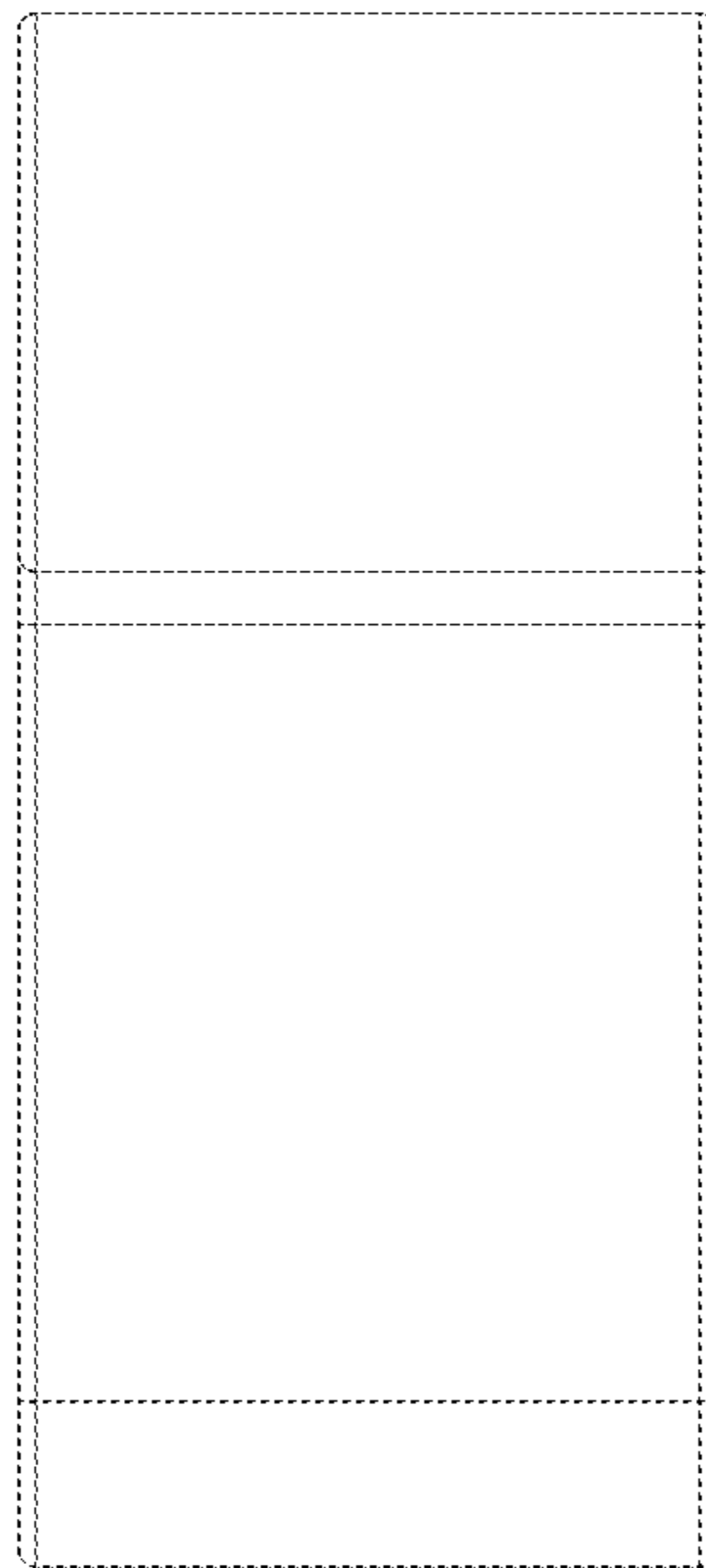

Fig. 5

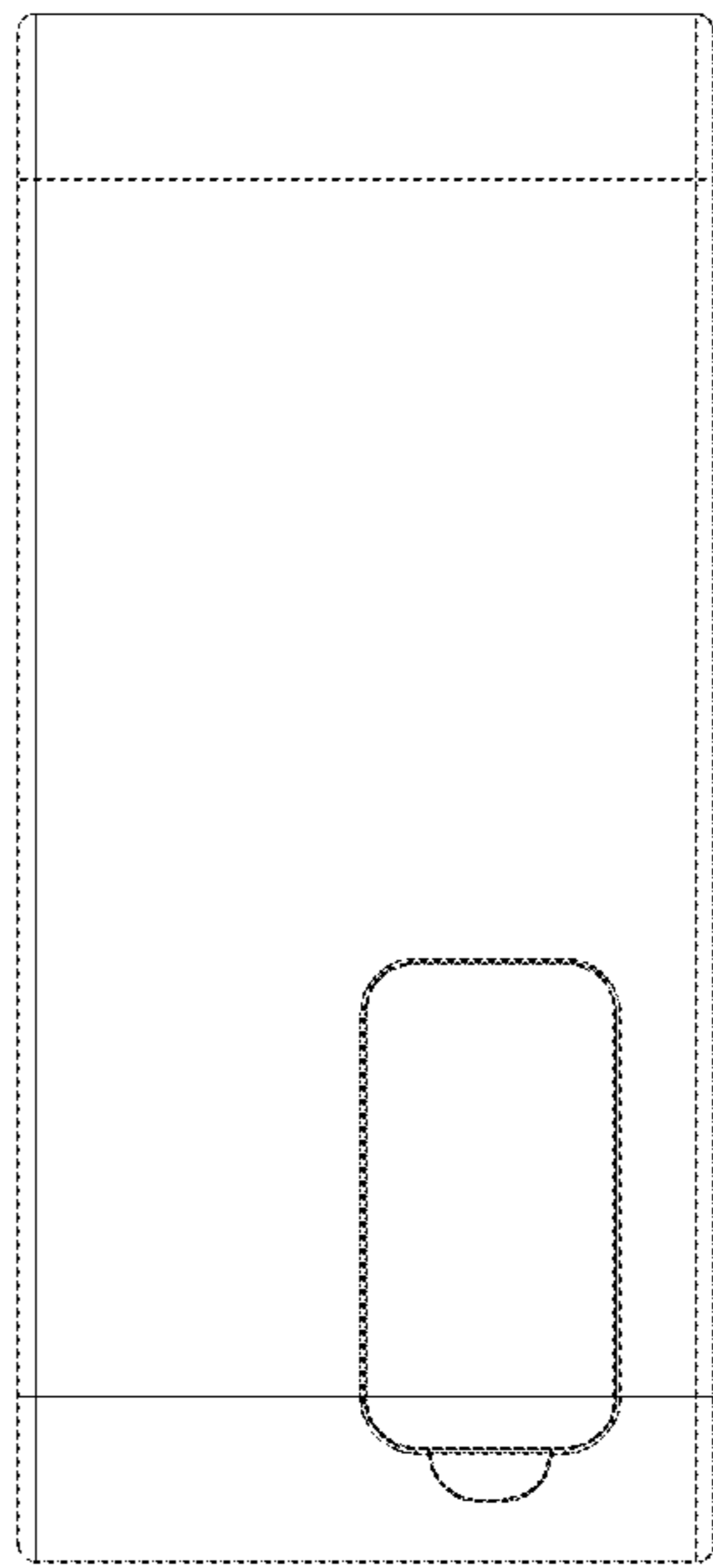

Fig. 6



Fig. 7

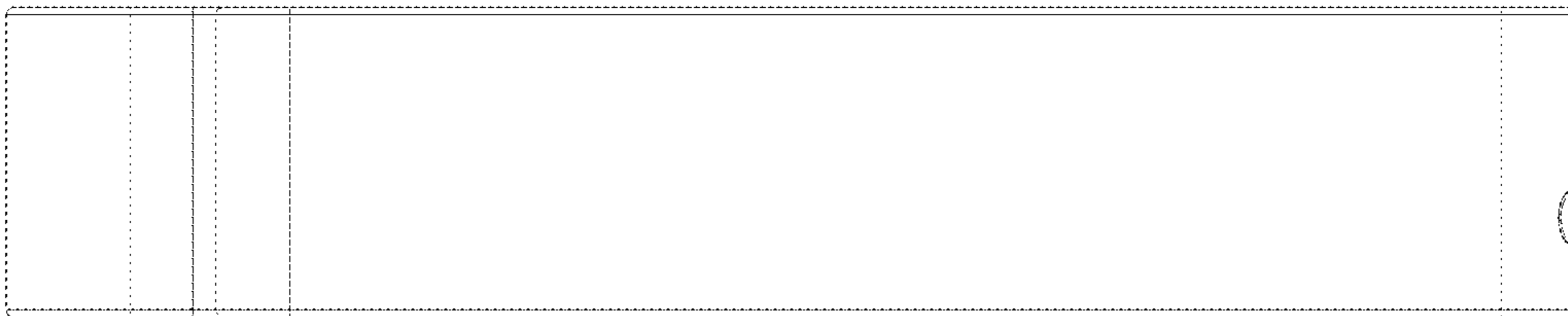

Fig. 8