

US00D765581S

(12) **United States Design Patent** (10) **Patent No.:** **US D765,581 S**
Pumphrey (45) **Date of Patent:** **** Sep. 6, 2016**

(54) **PERSONAL DIGITAL DEVICE HANGER**

(71) Applicant: **Richard Blake Pumphrey**, Apex, NC (US)

(72) Inventor: **Richard Blake Pumphrey**, Apex, NC (US)

(**) Term: **15 Years**

(21) Appl. No.: **29/536,085**

(22) Filed: **Aug. 13, 2015**

Related U.S. Application Data

(63) Continuation-in-part of application No. 29/534,815, filed on Jul. 31, 2015.

(51) **LOC (10) Cl.** **12-16**

(52) **U.S. Cl.**
USPC **D12/416**

(58) **Field of Classification Search**
USPC D12/415-426.1
CPC F16M 11/12; F16M 11/10
See application file for complete search history.

(56) **References Cited**

U.S. PATENT DOCUMENTS

D603,322 S *	11/2009	Nicieja	D12/415
D630,222 S *	1/2011	Lin	D14/447
D656,932 S *	4/2012	Wikel	D12/415
D663,726 S *	7/2012	Gourley	D14/251
D690,707 S *	10/2013	Minn	D14/447
D712,394 S *	9/2014	Booth	D14/253

D726,640 S *	4/2015	Frey	D12/415
D735,112 S *	7/2015	Deng	D12/415
D757,705 S *	5/2016	Esses	D14/251
2014/0138419 A1 *	5/2014	Minn	B60R 11/0241 224/567

* cited by examiner

Primary Examiner — Katrina A Betton

(74) *Attorney, Agent, or Firm* — Mathew L. Grell; Grell & Watson Patent Attorneys

(57) **CLAIM**

The ornamental design for a personal digital device hanger, as shown and described.

DESCRIPTION

FIG. 1 is a perspective view of a personal digital device hanger showing my design;
FIG. 2 is a left or right side view thereof;
FIG. 3 is a top side view thereof;
FIG. 4 is a bottom side view thereof;
FIG. 5 is a front side view thereof;
FIG. 6 is a back side view thereof; and,
FIG. 7 is a perspective view of an airline seat tray shown in the upright tray position with the personal digital device positioned thereon the airline seat tray holding the personal digital device.

The broken lines shown in FIGS. 5-7 represent the portions of the design which form no part of the claim.

The disclosure relates generally to ornamental designs for hangers, and more specifically to an ornamental design for a hanger to hold a personal digital device.

1 Claim, 5 Drawing Sheets

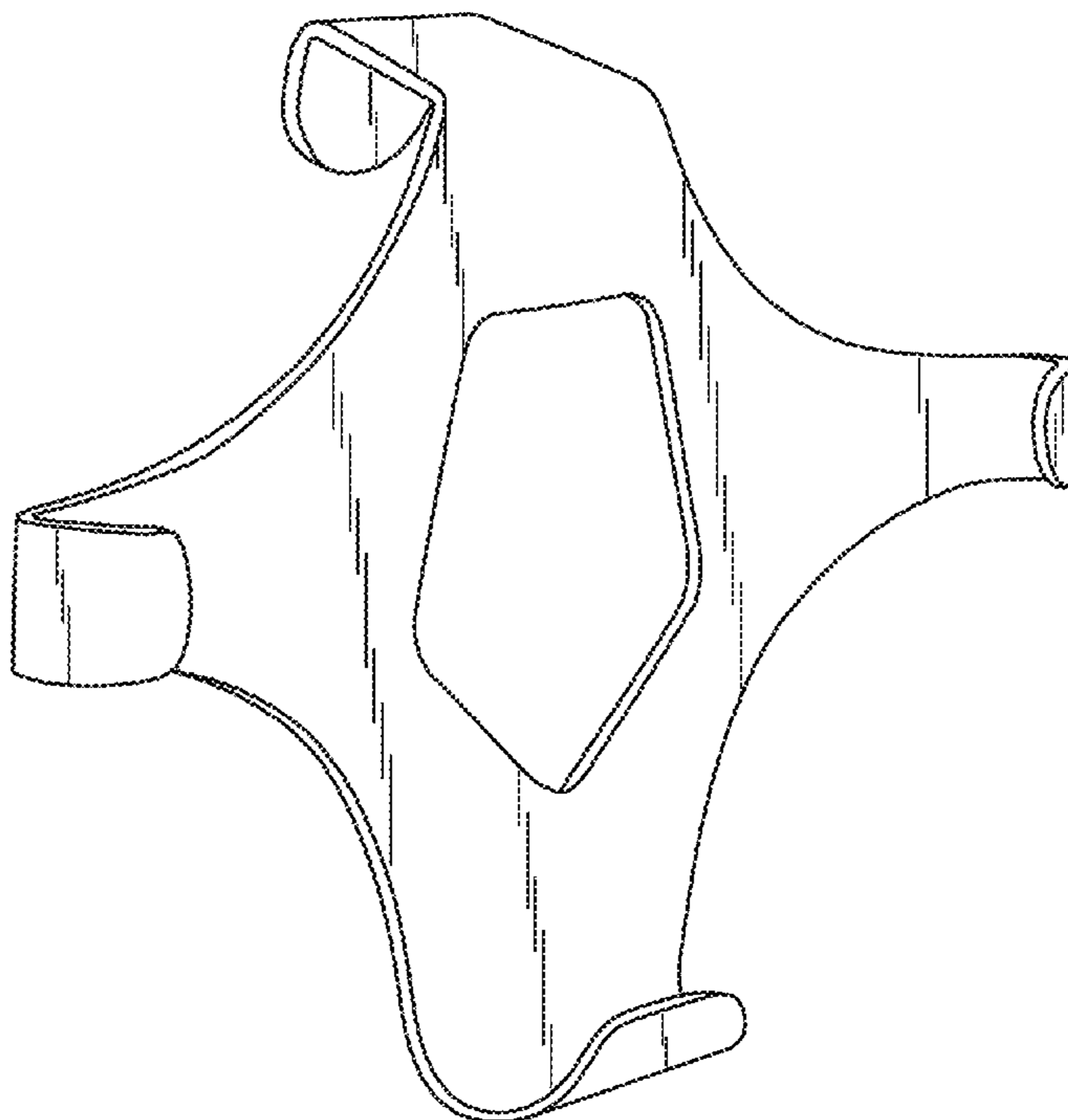

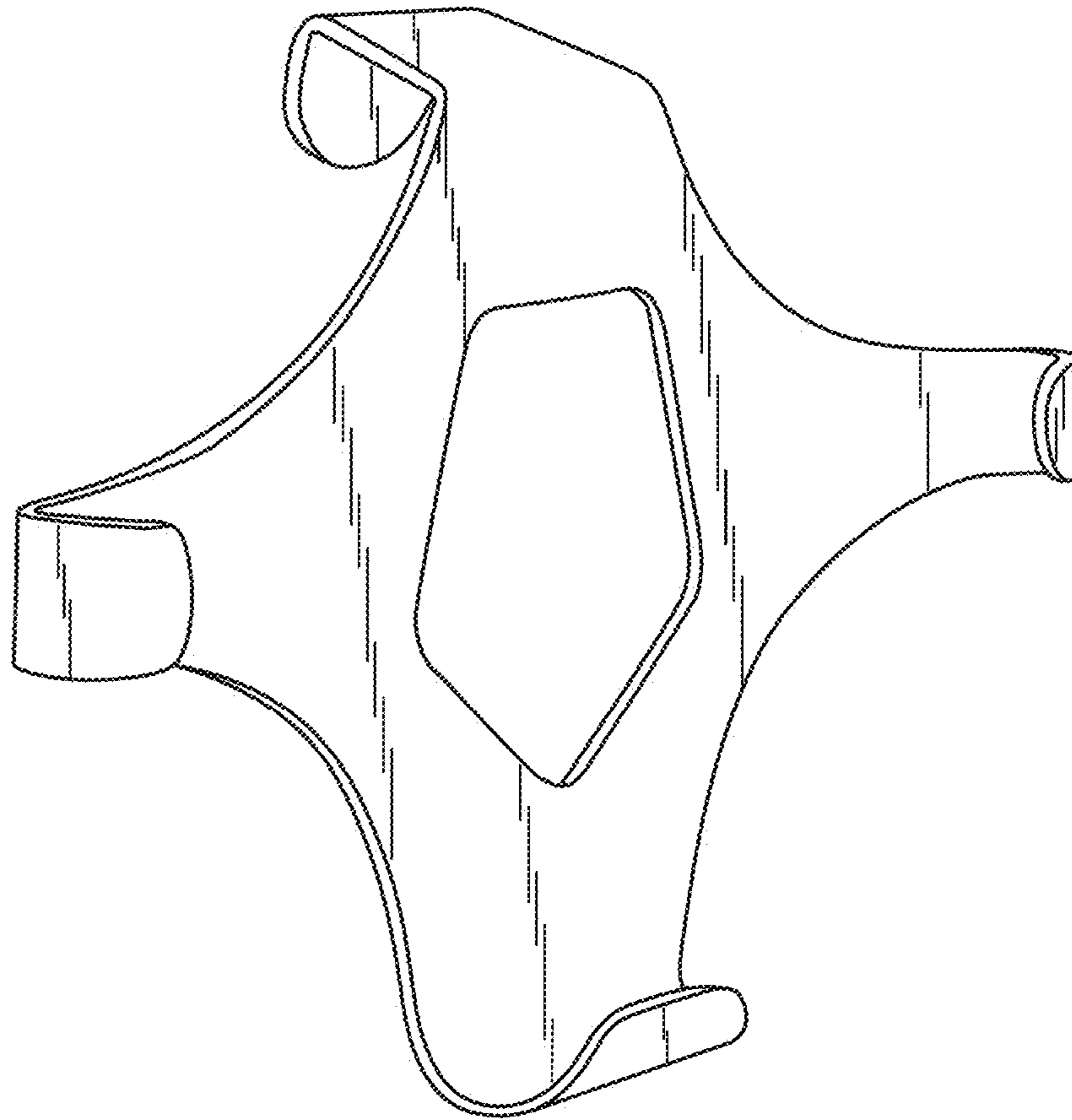

FIG. 1

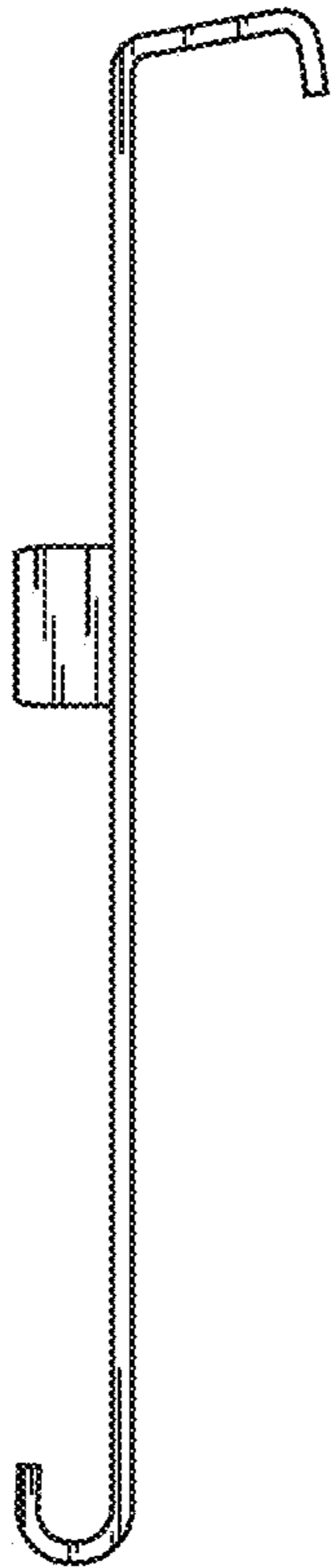

FIG. 2

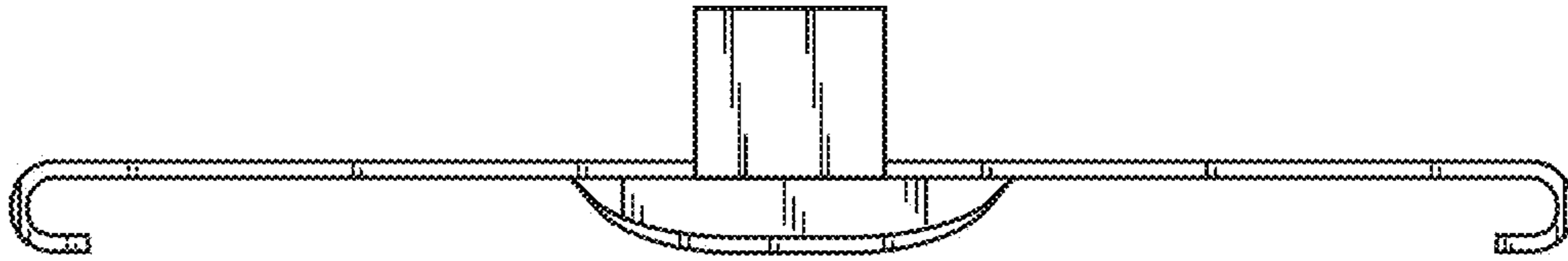

FIG. 3

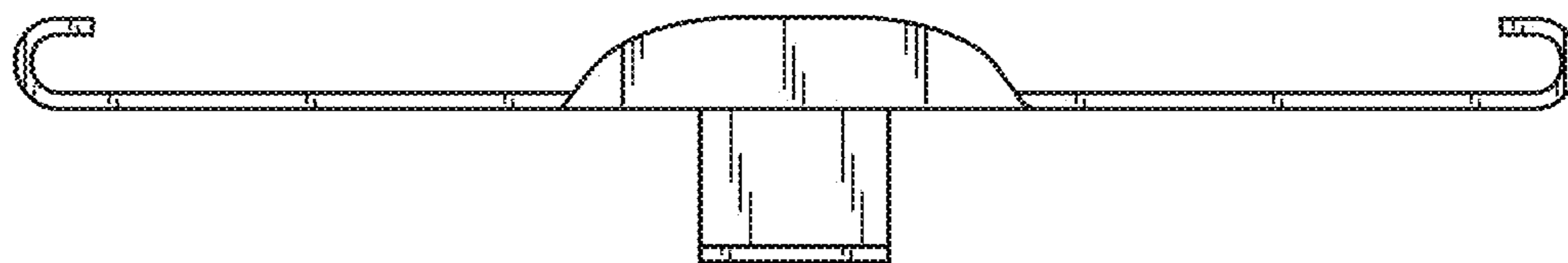

FIG. 4

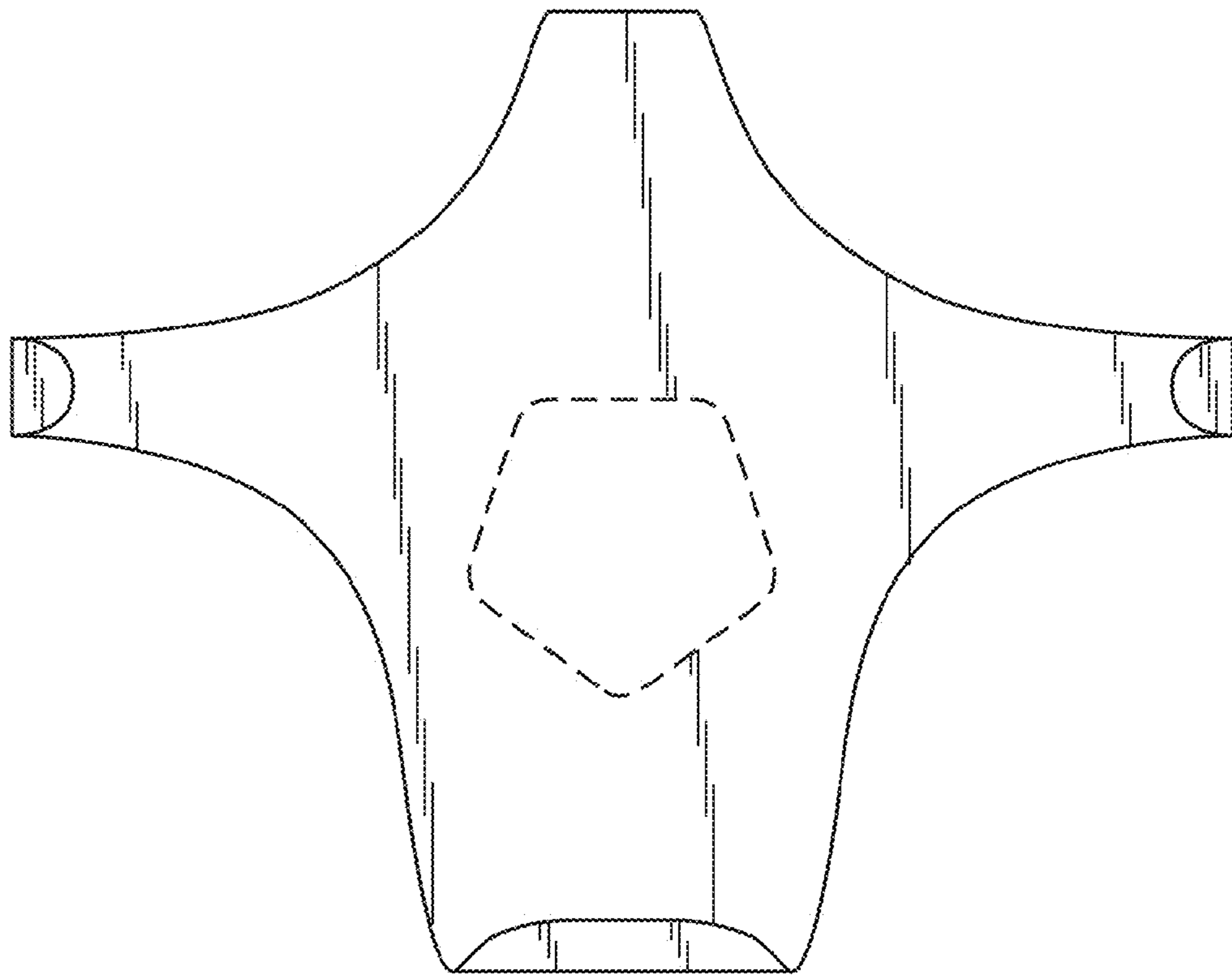

FIG. 5

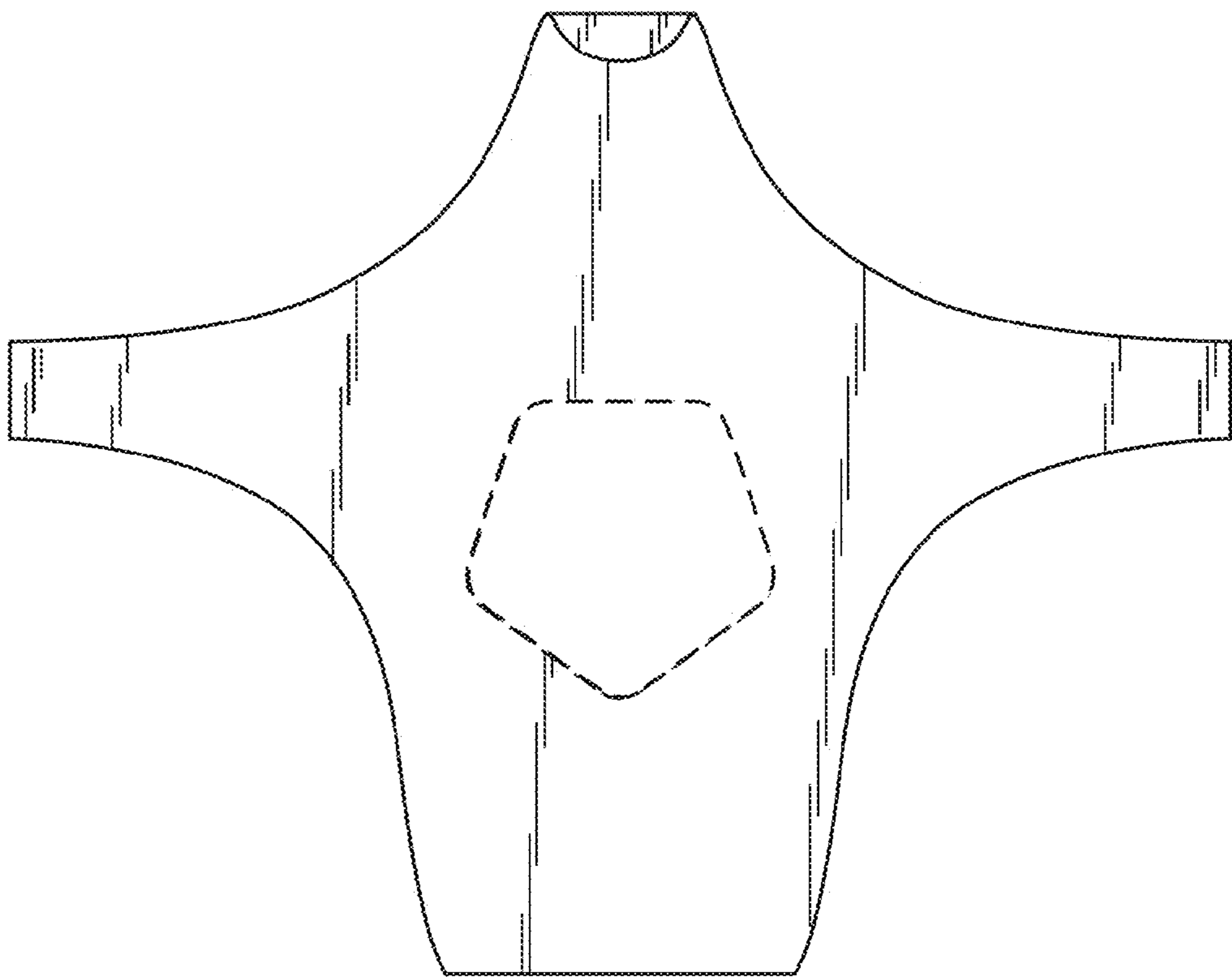

FIG. 6

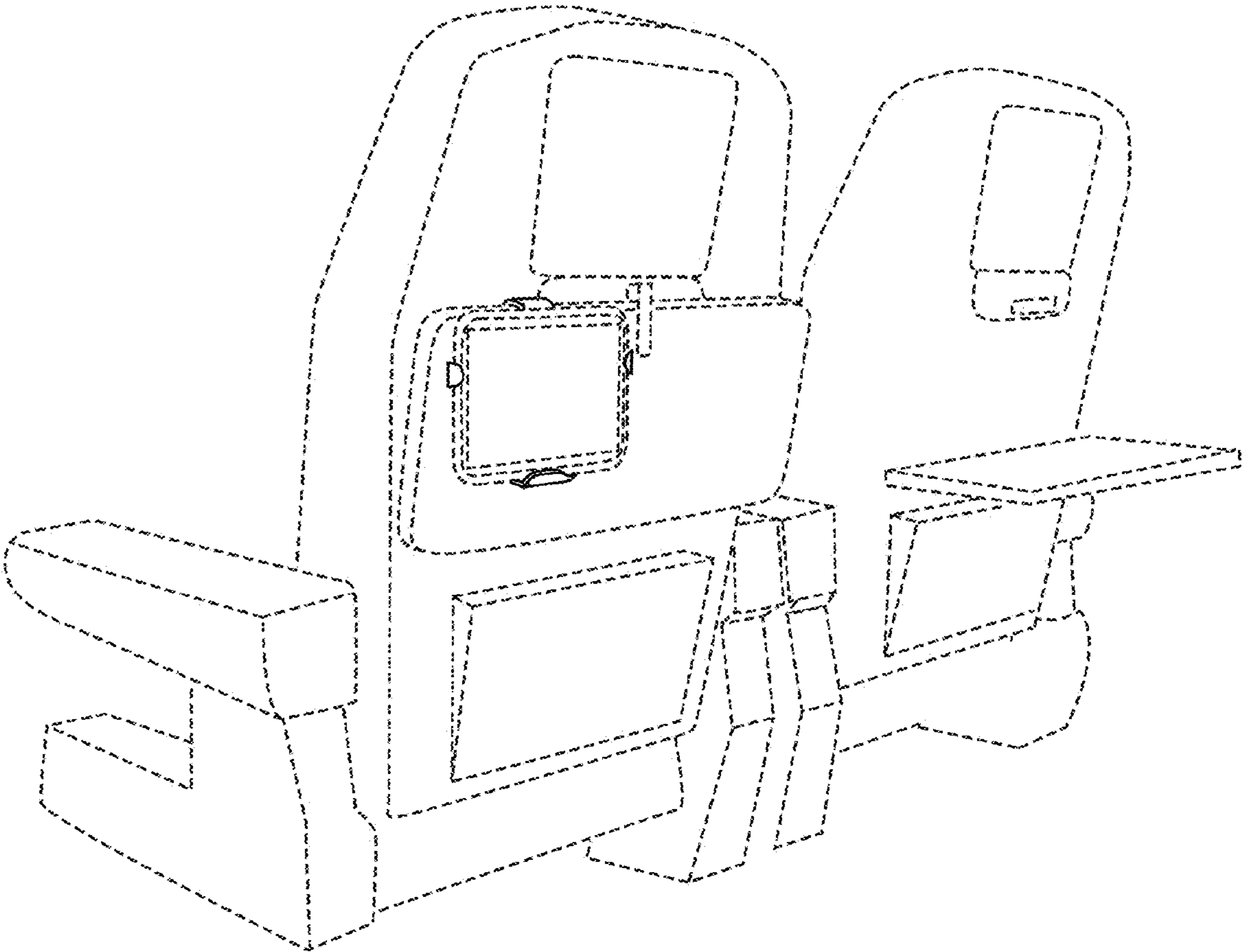

FIG. 7