



US00D765580S

(12) **United States Design Patent** (10) **Patent No.:** **US D765,580 S**  
**Pumphrey** (45) **Date of Patent:** **\*\* Sep. 6, 2016**

- (54) **AIRLINE TRAY HANGER**
- (71) Applicant: **Richard Blake Pumphrey**, Apex, NC (US)
- (72) Inventor: **Richard Blake Pumphrey**, Apex, NC (US)
- (\*\*) Term: **15 Years**
- (21) Appl. No.: **29/534,815**
- (22) Filed: **Jul. 31, 2015**
- (51) **LOC (10) Cl.** ..... **12-16**
- (52) **U.S. Cl.**  
USPC ..... **D12/415**
- (58) **Field of Classification Search**  
CPC ..... F16M 11/12; F16M 11/10; B64D 11/06  
See application file for complete search history.

- (56) **References Cited**  
U.S. PATENT DOCUMENTS
- |           |     |         |           |       |            |         |
|-----------|-----|---------|-----------|-------|------------|---------|
| 2,601,177 | A * | 6/1952  | Smullen   | ..... | B60N 3/004 | 108/47  |
| 5,005,491 | A * | 4/1991  | Waterman  | ..... | B60N 3/007 | 108/152 |
| 5,722,586 | A * | 3/1998  | Hansen    | ..... | B60N 3/004 | 108/44  |
| D393,242  | S * | 4/1998  | Wood      | ..... | D12/416    |         |
| D401,214  | S * | 11/1998 | Benavidez | ..... | D12/416    |         |
| D473,840  | S * | 4/2003  | Sauer     | ..... | D12/416    |         |

- D627,291 S \* 11/2010 Lindsay, Jr. .... D12/416
- D638,347 S \* 5/2011 Davis ..... D12/416
- 2014/0377499 A1\* 12/2014 Davino ..... B64D 11/0638  
428/99

\* cited by examiner

*Primary Examiner* — Katrina A Betton  
(74) *Attorney, Agent, or Firm* — Mathew L. Grell; Grell & Watson Patent Attorneys

(57) **CLAIM**  
The ornamental design for an airline tray hanger, as shown and described.

**DESCRIPTION**

FIG. 1 is a perspective view of an airline tray hanger showing my design;  
FIG. 2 is a left or right side view thereof;  
FIG. 3 is a top view thereof;  
FIG. 4 is a bottom view thereof;  
FIG. 5 is a front view thereof;  
FIG. 6 is a back view thereof; and,  
FIG. 7 is a perspective view of an airline seat tray shown in the upright tray position with an airline tray hanger positioned thereon the airline seat tray holding a personal digital device.

The broken lines shown in FIG. 7 represent the portions of the design which form no part of the claim.

The disclosure relates generally to ornamental designs for hangers, and more specifically to an ornamental design for an airline tray hanger to hold a personal digital device.

**1 Claim, 5 Drawing Sheets**

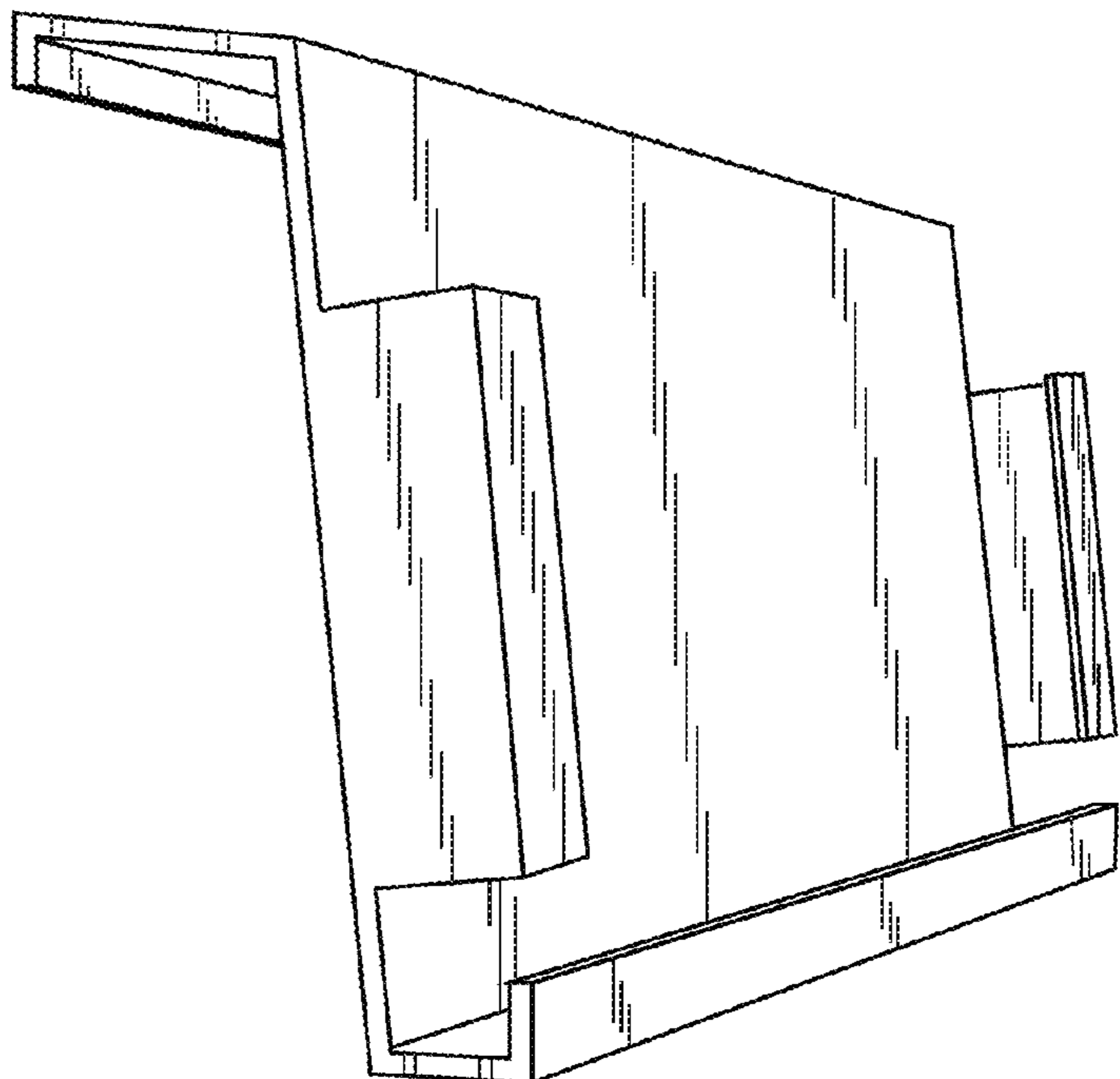

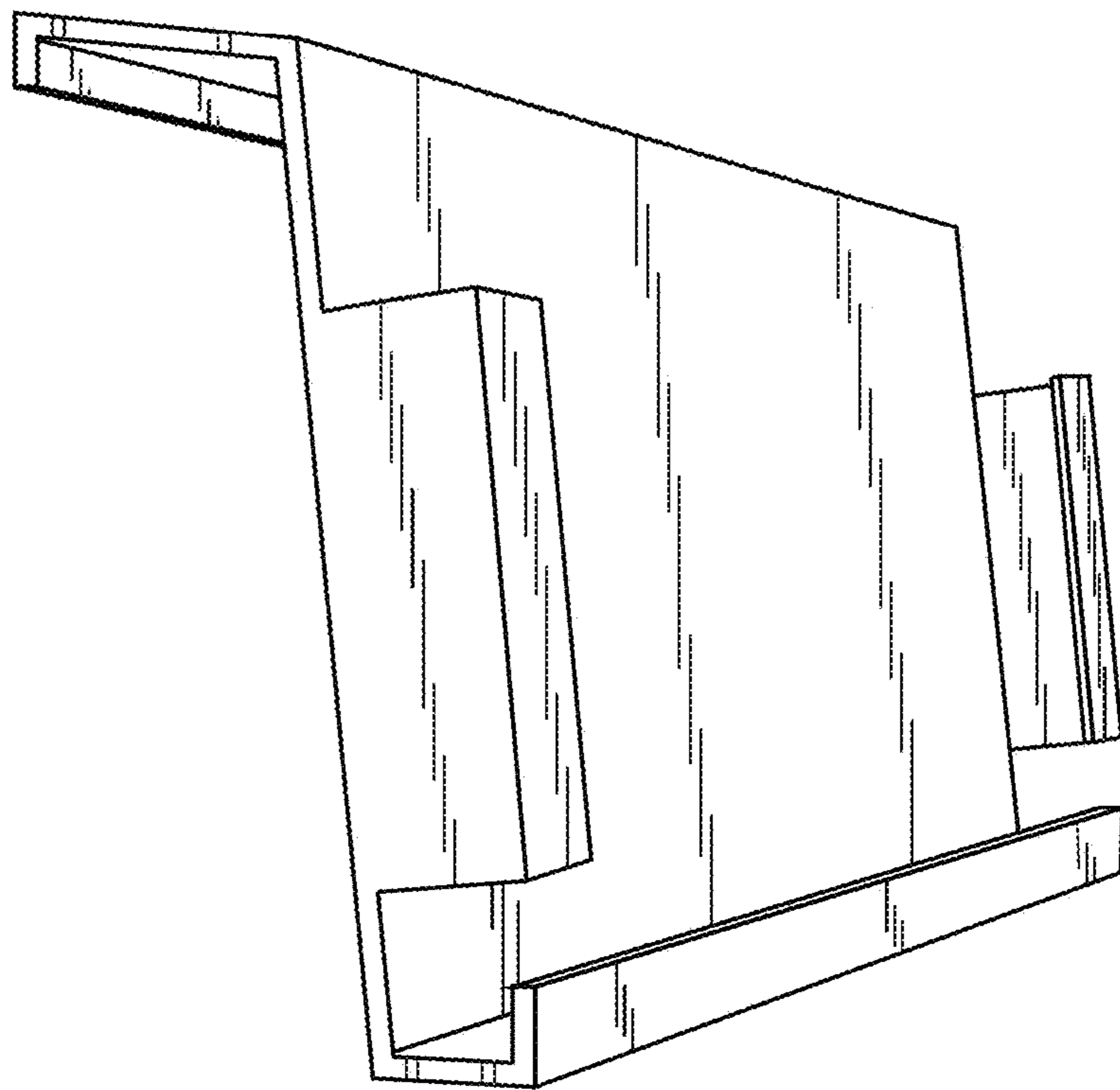

FIG. 1

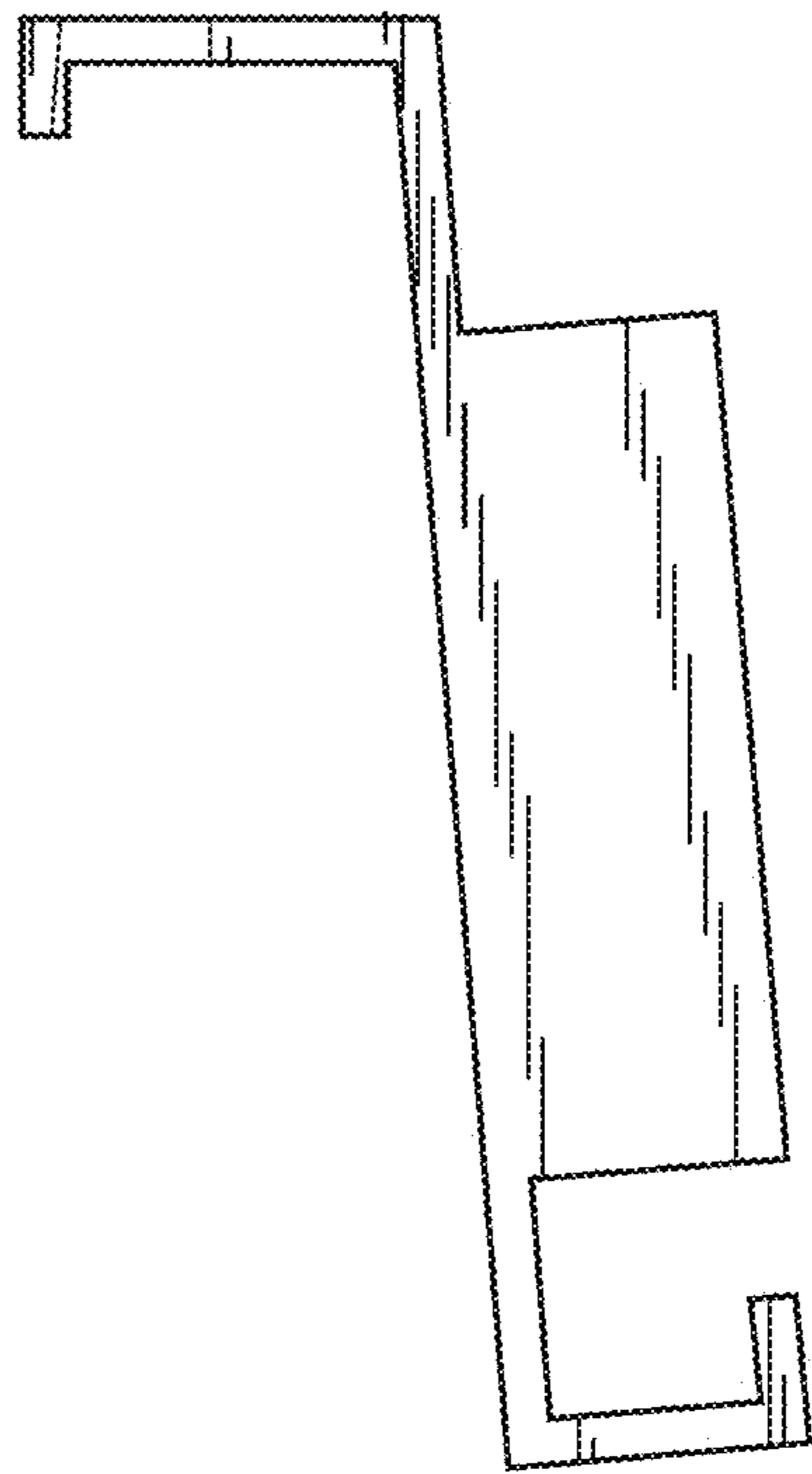

FIG. 2

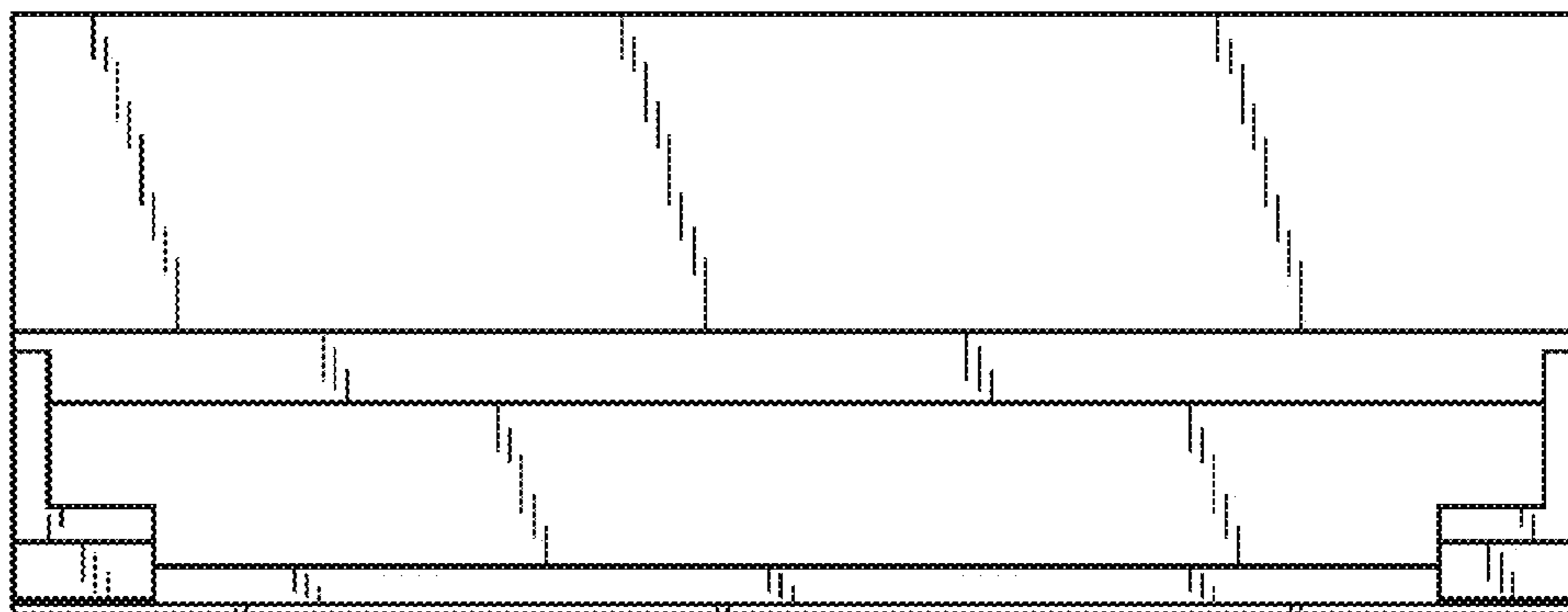

FIG. 3

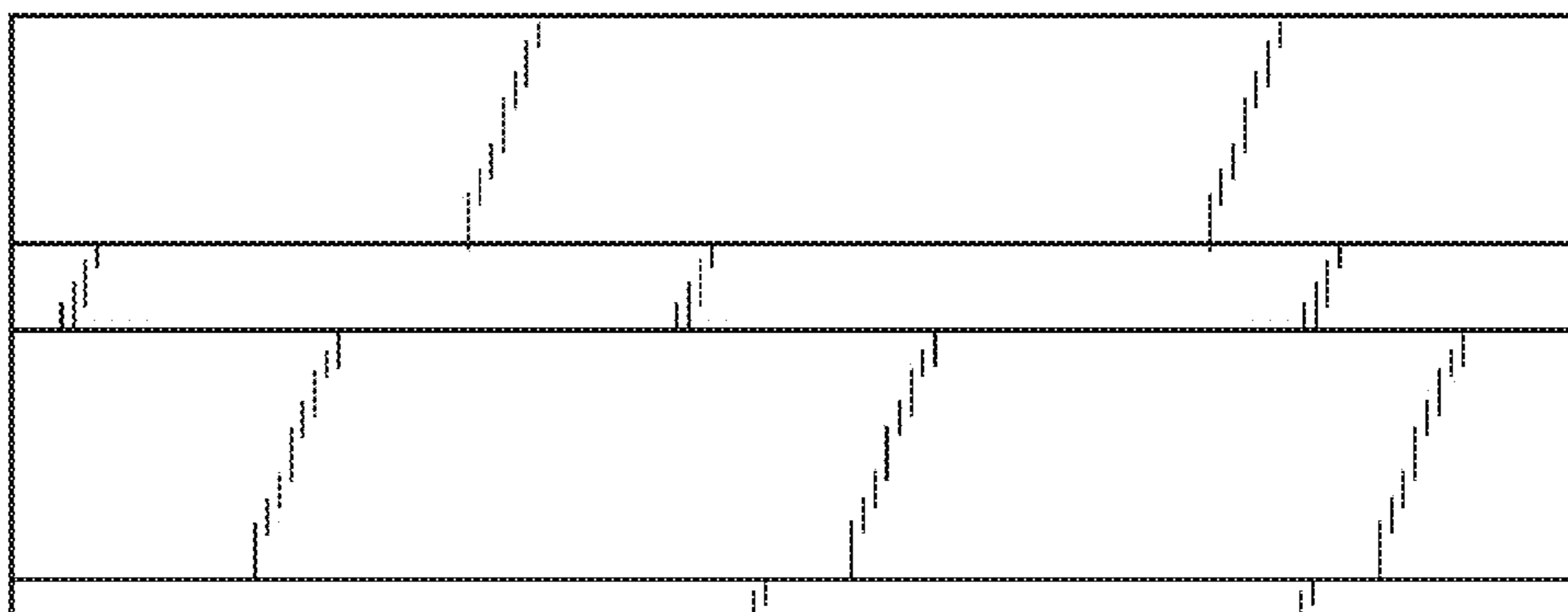

FIG. 4

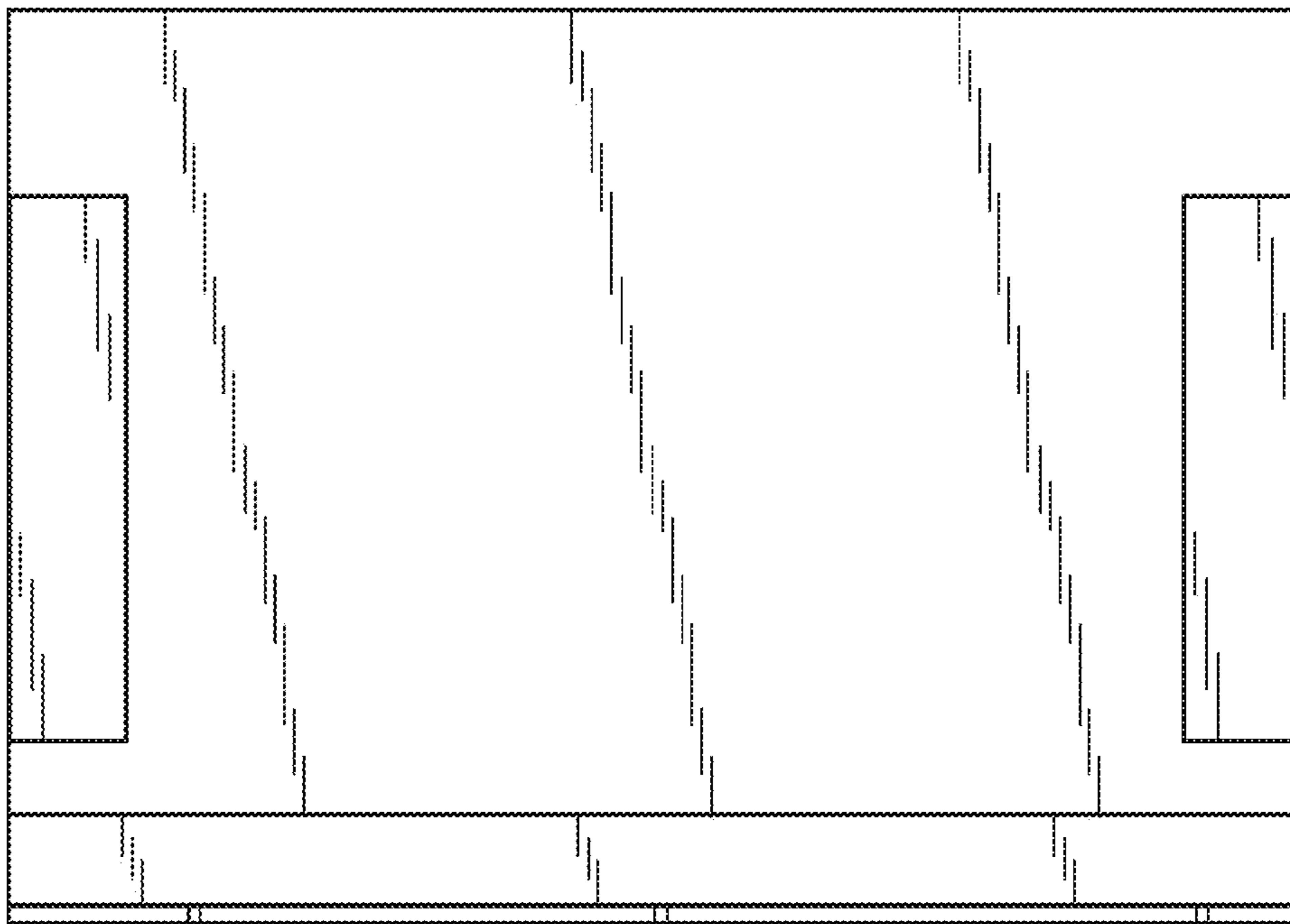

FIG. 5

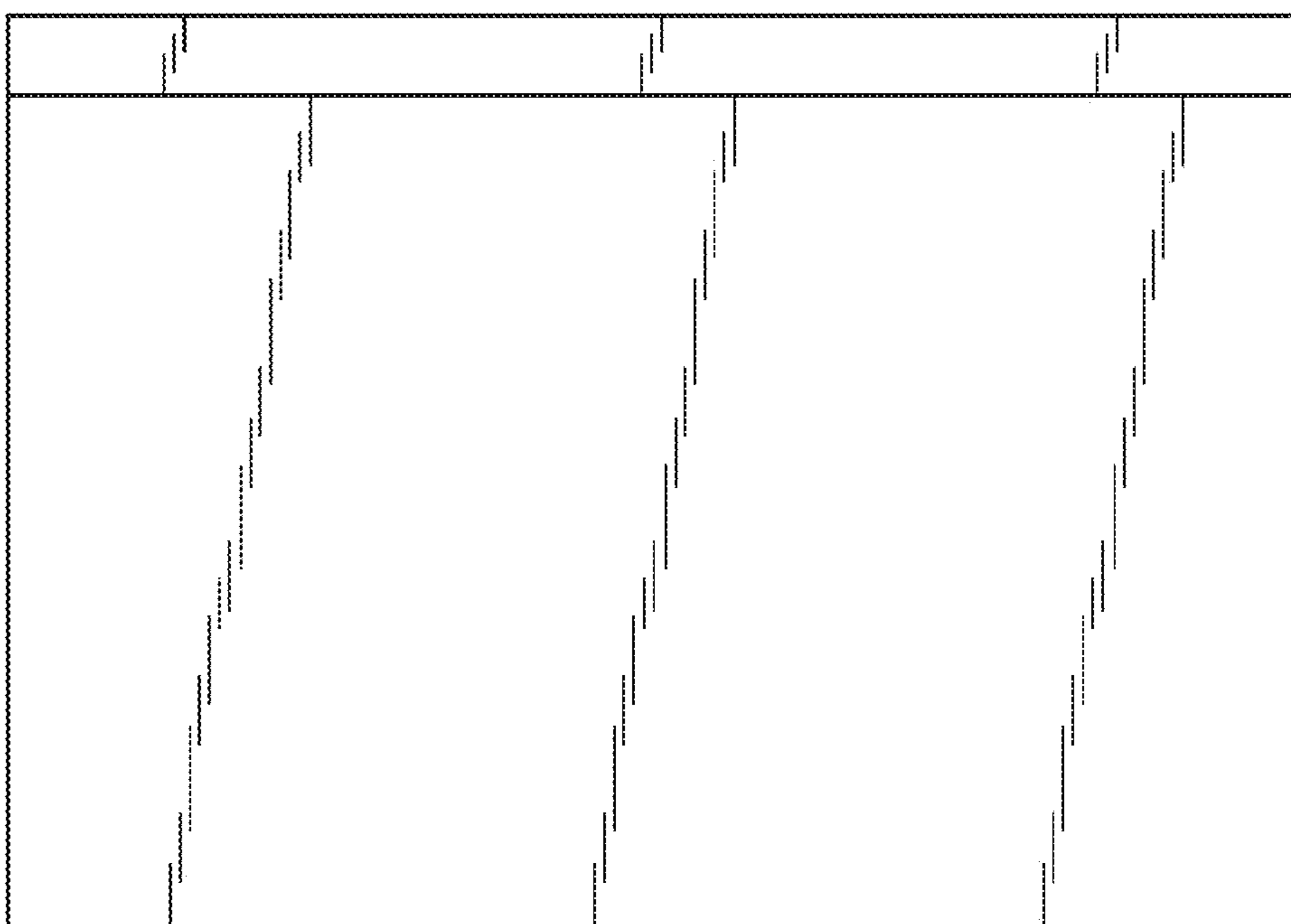

FIG. 6

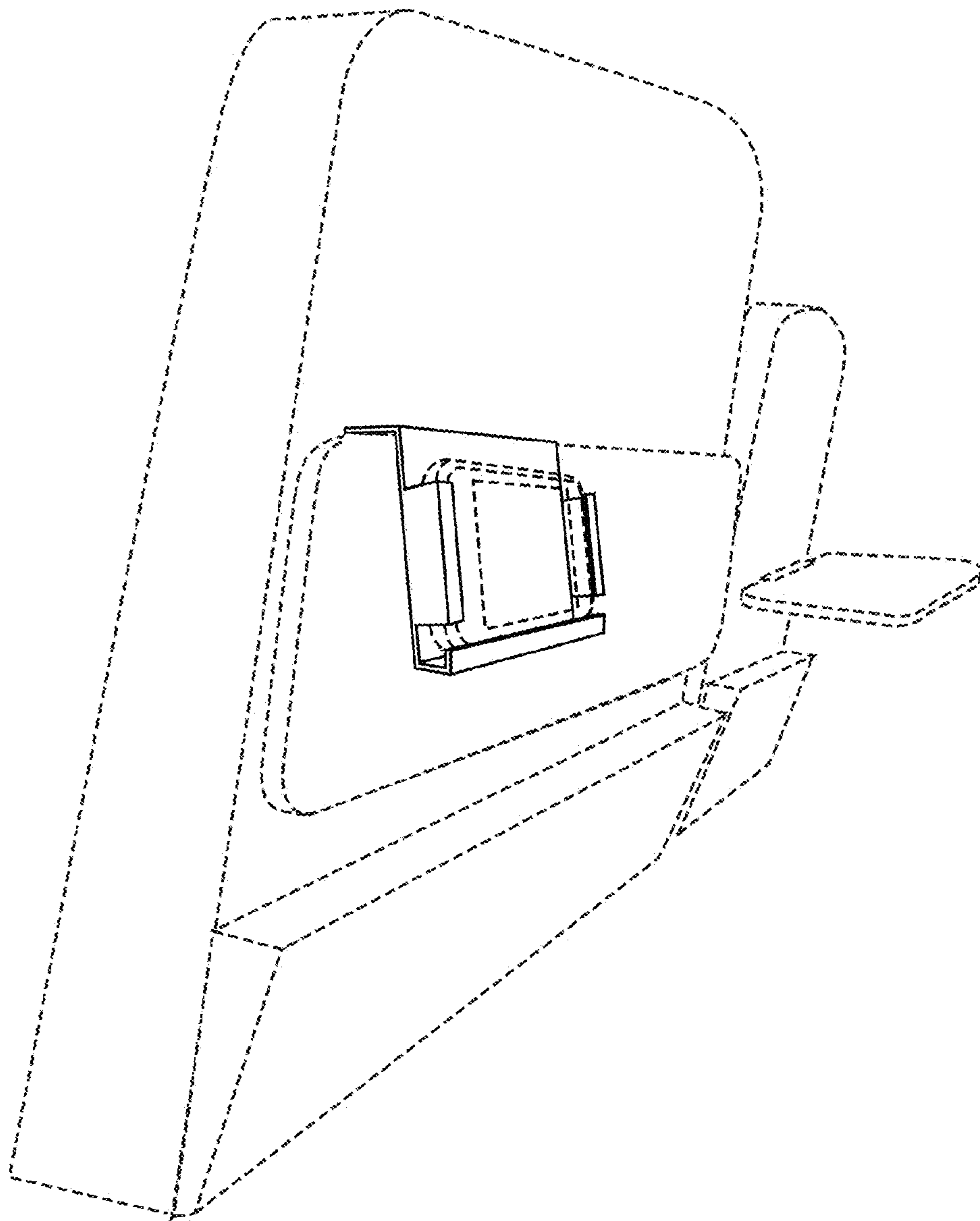

FIG. 7