



US00D76552S

(12) **United States Design Patent**
M•rk et al.

(10) **Patent No.:** **US D765,552 S**

(45) **Date of Patent:** **** Sep. 6, 2016**

(54) **LEG LIFT**

(71) Applicant: **ArjoHuntleigh AB**, Malmo (SE)

(72) Inventors: **Anna M•rk**, Göteborg (SE); **Andreas Thomasson**, Sjöbo (SE); **Bodil Åkesson**, Löddeköpinge (SE); **Daniel Rubin**, Barsebäck (SE); **Maria Wårell**, Höör (SE); **Ola Gribbling**, Malmö (SE); **Richard Nilsson**, Lund (SE)

(73) Assignee: **ArjoHuntleigh AB**, Malmo (SE)

(**) Term: **14 Years**

(21) Appl. No.: **29/498,201**

(22) Filed: **Jul. 31, 2014**

(30) **Foreign Application Priority Data**

Jul. 17, 2014 (EM) 002504035

(51) **LOC (10) Cl.** **12-12**

(52) **U.S. Cl.**
USPC **D12/128**

(58) **Field of Classification Search**
USPC D12/128, 130, 133
CPC A61H 3/04; A61H 2201/0161
See application file for complete search history.

(56) **References Cited**

U.S. PATENT DOCUMENTS

4,993,085 A * 2/1991 Gibbons 4/667
5,309,584 A * 5/1994 Parker 5/87.1

5,467,793 A * 11/1995 Hart 135/67
D401,192 S * 11/1998 Gagnon D12/133
6,361,517 B1 * 3/2002 Slinger 602/28
D489,026 S * 4/2004 Taylor D12/133
D530,651 S * 10/2006 Shaffer D12/133
D577,919 S * 10/2008 Koshiishi D6/354
D588,794 S * 3/2009 Koshiishi D3/7
D614,394 S * 4/2010 Koshiishi D3/7
D648,248 S * 11/2011 Braaten D12/133
D677,877 S * 3/2013 Ito D3/7
2015/0018739 A1 * 1/2015 Threlfall 602/23

* cited by examiner

Primary Examiner — Charles Hanson

(74) *Attorney, Agent, or Firm* — Fenwick & West LLP

(57) **CLAIM**

The ornamental design for a leg lift, as shown and described.

DESCRIPTION

FIG. 1 is a perspective view of a leg lift, showing our new design;
FIG. 2 is a front perspective view thereof;
FIG. 3 is a back perspective view thereof;
FIG. 4 is a right perspective view thereof;
FIG. 5 is a left perspective view thereof;
FIG. 6 is a top perspective view thereof; and,
FIG. 7 is a bottom perspective view thereof.

1 Claim, 5 Drawing Sheets

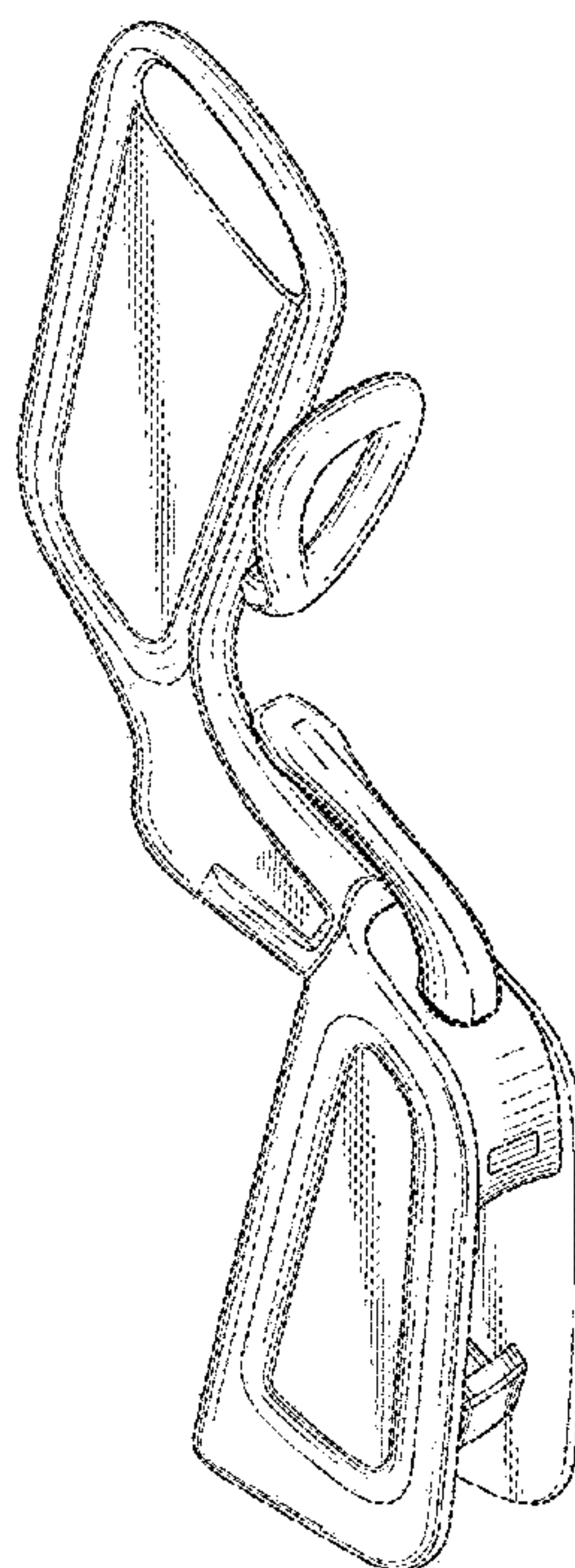

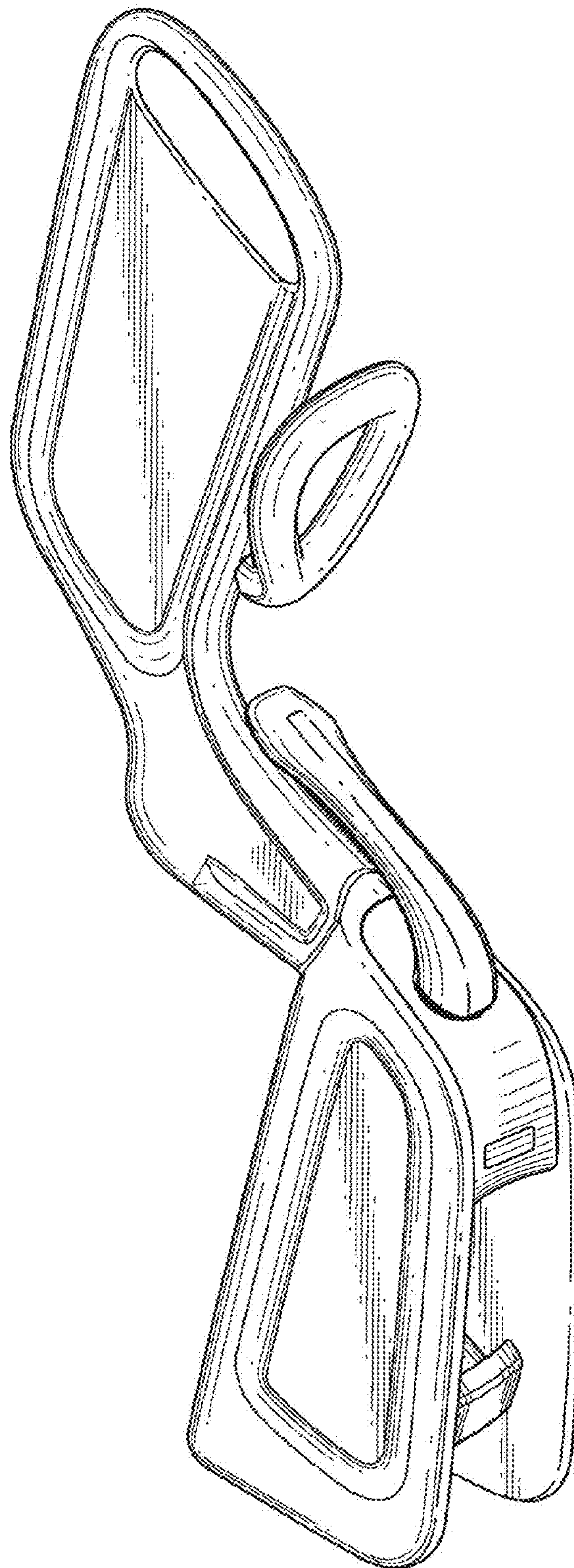

FIG. 1

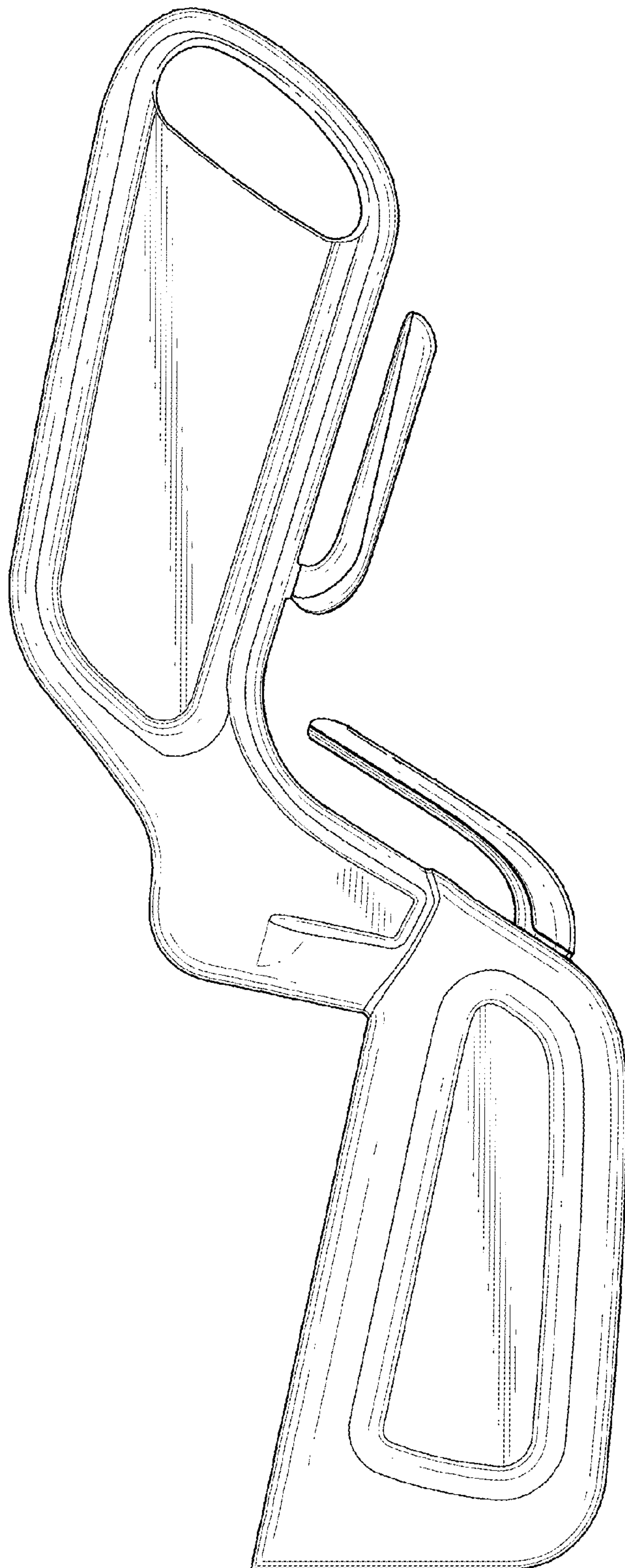

FIG. 2

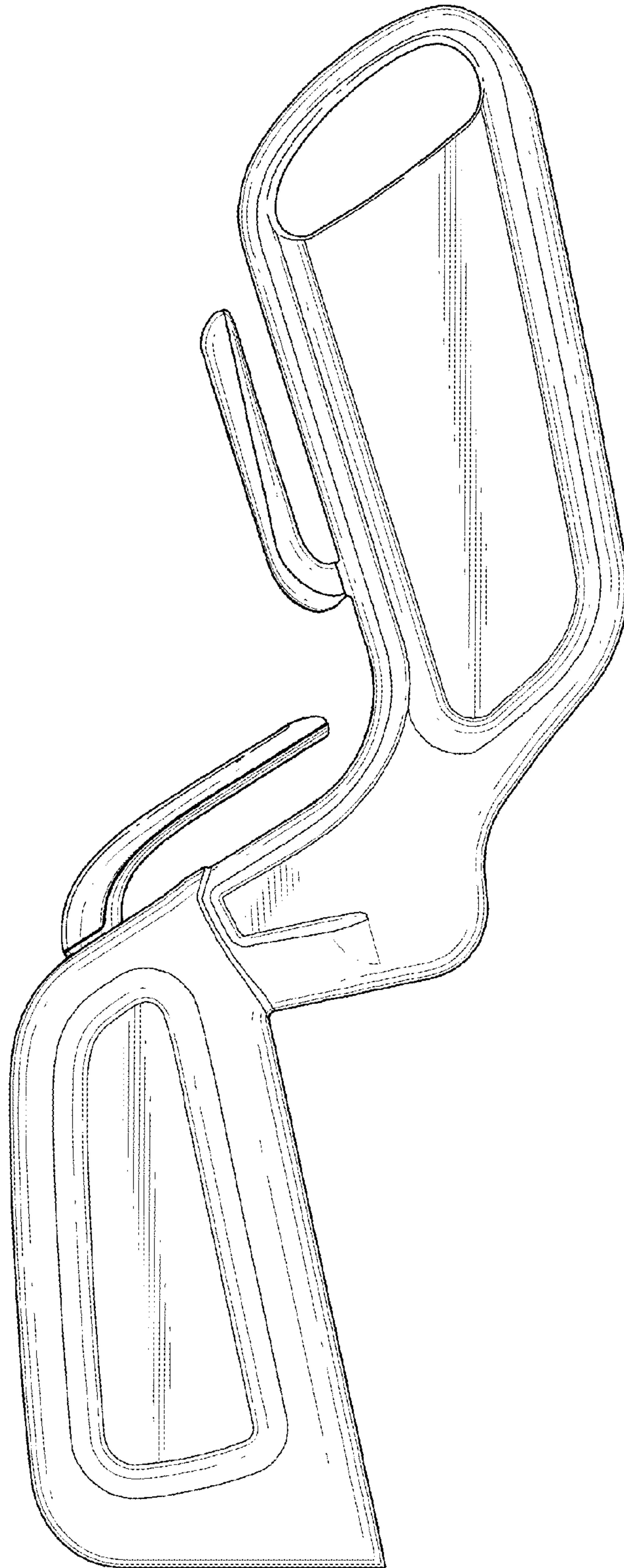

FIG. 3

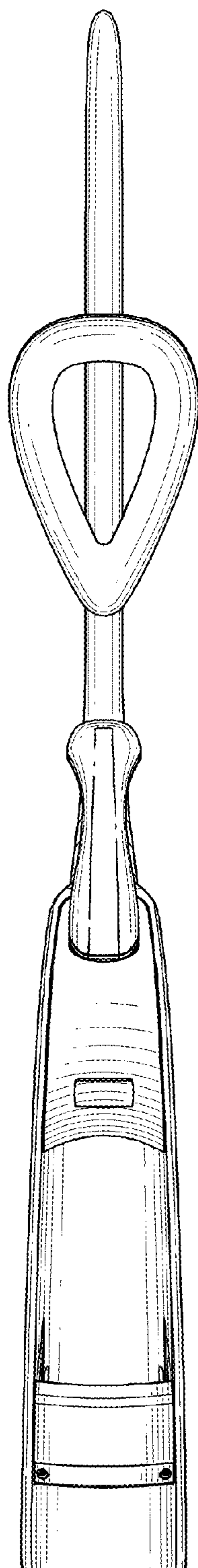

FIG. 4

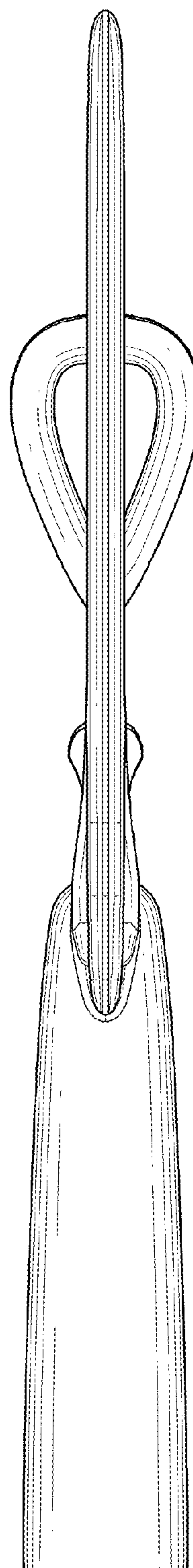

FIG. 5

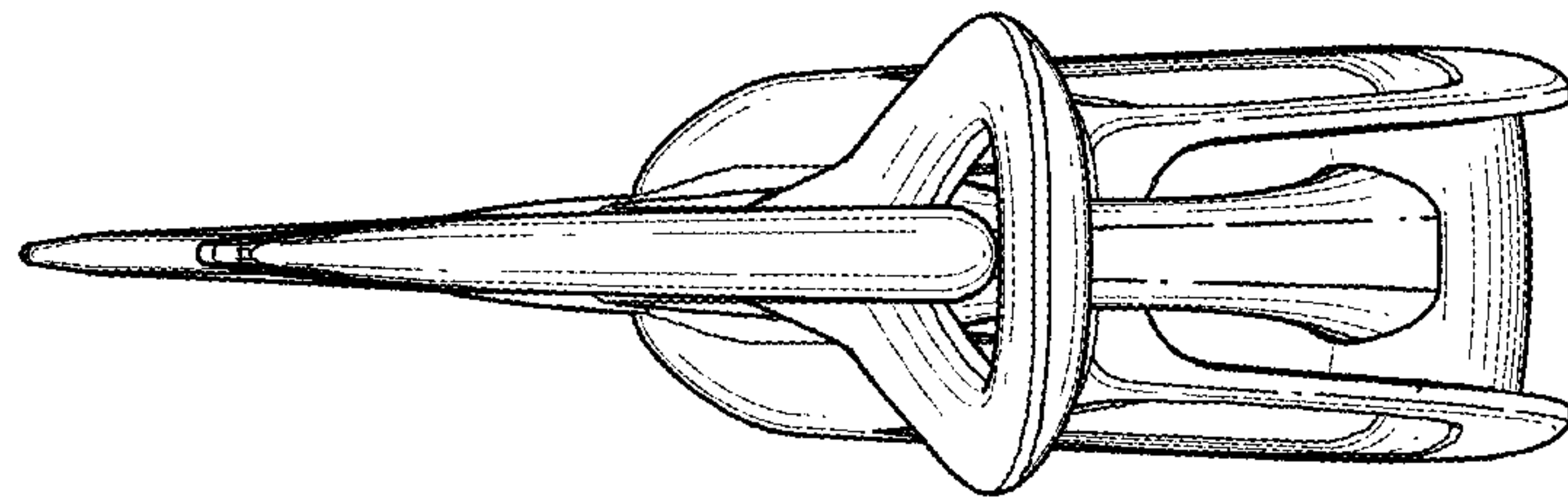

FIG. 6

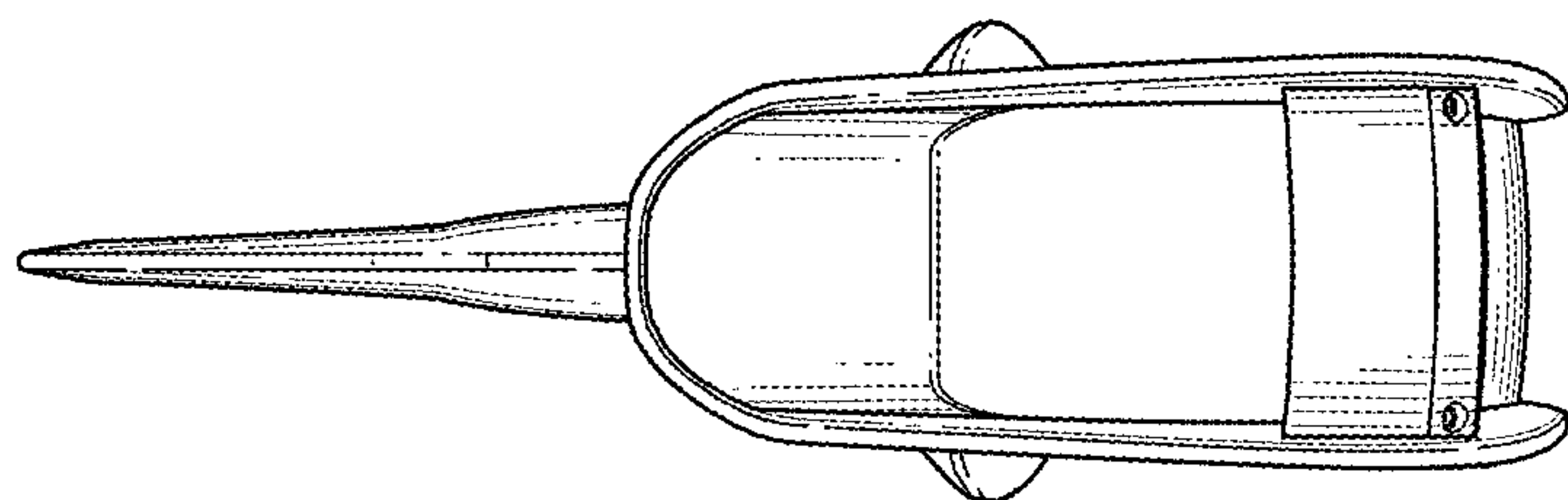

FIG. 7