



US00D765520S

(12) **United States Design Patent** (10) **Patent No.:** **US D765,520 S**
Gunder (45) **Date of Patent:** **** Sep. 6, 2016**

(54) **BLISTER PACKAGE**
(71) Applicant: **The Coca-Cola Company**, Atlanta, GA (US)
(72) Inventor: **Terri Gunder**, Lawrenceville, GA (US)
(73) Assignee: **The Coca-Cola Company**, Atlanta, GA (US)
(**) Term: **14 Years**
(21) Appl. No.: **29/478,639**
(22) Filed: **Jan. 7, 2014**
(51) **LOC (10) Cl.** **09-01**
(52) **U.S. Cl.**
USPC **D9/732**
(58) **Field of Classification Search**
USPC D9/414, 415, 418, 424, 430, 696, 707, D9/715, 722, 730, 732; 206/229, 461, 471, 206/525.1, 562, 563, 569, 570, 586, 822; D3/201, 202, 269; D24/227
CPC B65D 75/366; B65D 75/36; B65D 2581/055; B65D 75/32; B65D 73/0092; B65D 1/36; B65D 81/113; B65D 75/22; B65D 43/162; B65D 2543/00296; B65D 75/322; B65D 75/326; B65D 81/133; B65D 5/503; Y10S 206/822; Y10S 299/904; Y10S 206/823
See application file for complete search history.

(56) **References Cited**
U.S. PATENT DOCUMENTS
2,880,864 A * 4/1959 Russo A47J 47/16 206/231
D186,900 S * 12/1959 Griese 220/573.1
3,064,402 A * 11/1962 Crane, Jr. B65D 73/0092 206/463
D206,493 S * 12/1966 Horner D9/415
3,298,515 A * 1/1967 Watts, Jr. B65D 73/0092 206/462
3,913,734 A * 10/1975 Siegel B65D 75/366 206/459.5

D238,480 S * 1/1976 Hjelmquist D9/425
4,921,137 A * 5/1990 Heijenga B65D 75/5811 206/469
5,009,310 A * 4/1991 Finney B65D 25/20 206/229
5,111,932 A * 5/1992 Campbell B65D 75/5855 206/216
D330,331 S * 10/1992 Hsiao D9/732
D381,263 S * 7/1997 O'Brien D9/415
D435,440 S * 12/2000 Croft D9/696
D437,777 S * 2/2001 Wootton D9/415
D442,078 S * 5/2001 Fuquen D9/696
D495,721 S * 9/2004 Glassgold D15/90
D537,345 S * 2/2007 Duquet D9/517
D543,866 S * 6/2007 Mikkelsen D9/732
D581,780 S * 12/2008 Senter D9/415
D584,607 S * 1/2009 Ajootian D9/415

(Continued)

FOREIGN PATENT DOCUMENTS

EM 000085170-0001 10/2003
EM 000085170-0002 10/2003

(Continued)

Primary Examiner — Derrick Holland
Assistant Examiner — Lauren Calve
(74) *Attorney, Agent, or Firm* — Cynthia R. Parks; Parks IP Law LLC

(57) **CLAIM**
I claim the ornamental design for a blister package, as shown and described.

DESCRIPTION

FIG. 1 is a perspective view of a blister package in accordance with my design;
FIG. 2 is a left side view thereof;
FIG. 3 is a right side view thereof;
FIG. 4 is a front elevational view thereof;
FIG. 5 is a back elevational view thereof;
FIG. 6 is a top view thereof; and,
FIG. 7 is a bottom view thereof.
The broken lines shown represent unclaimed subject matter and form no part of the claimed design.

1 Claim, 2 Drawing Sheets

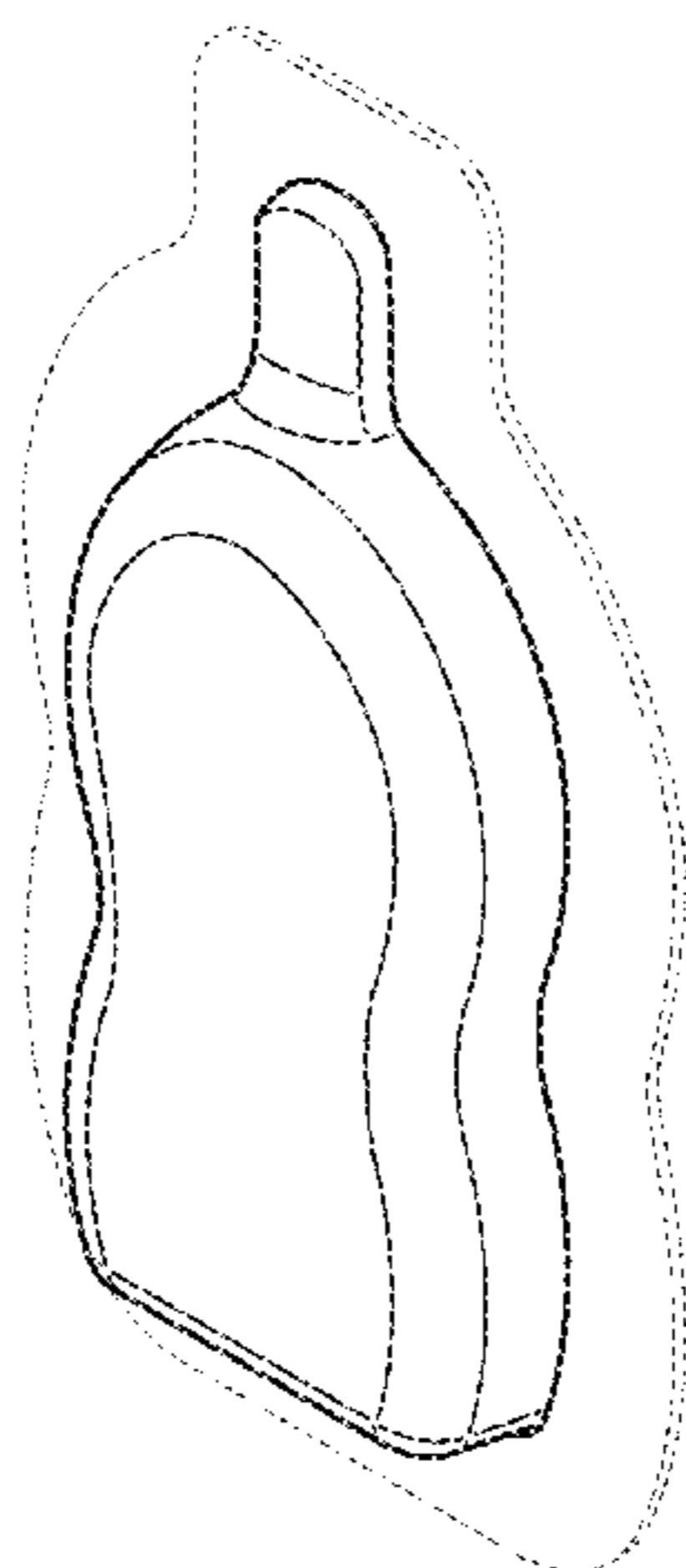

(56)

References Cited

U.S. PATENT DOCUMENTS

D620,809 S 8/2010 Caldwell et al.
 D628,902 S 12/2010 Schroeder et al.
 D632,564 S 2/2011 Caldwell et al.
 D632,565 S 2/2011 Caldwell et al.
 D632,566 S 2/2011 Caldwell et al.
 D632,567 S 2/2011 Caldwell et al.
 D632,569 S 2/2011 Caldwell et al.
 D634,615 S * 3/2011 Patel D9/416
 D634,643 S * 3/2011 Caldwell D9/707
 D660,718 S * 5/2012 McDermott D9/416
 D670,573 S 11/2012 McDermott et al.
 D703,063 S * 4/2014 Garrity D9/695
 D703,064 S * 4/2014 Warrington D9/707
 D703,551 S * 4/2014 Kirchmayr D9/424
 D728,377 S * 5/2015 Marotti D9/696
 9,061,796 B2 * 6/2015 Caldwell B65D 21/0202

2007/0228073 A1* 10/2007 Mazzarino B65D 75/5811
 222/107
 2008/0123465 A1* 5/2008 Heusser B01F 5/064
 366/130
 2010/0125097 A1* 5/2010 Soll A01N 43/56
 514/407
 2013/0180871 A1* 7/2013 Welch B65D 65/46
 206/216

FOREIGN PATENT DOCUMENTS

EM 000694070-0001 3/2007
 EM 000837562-0001 12/2007
 EM 002108431-0005 9/2012
 WO DM073374 3/2010
 WO DM073433 4/2010
 WO DM075354 2/2011
 WO DM078543 3/2012

* cited by examiner

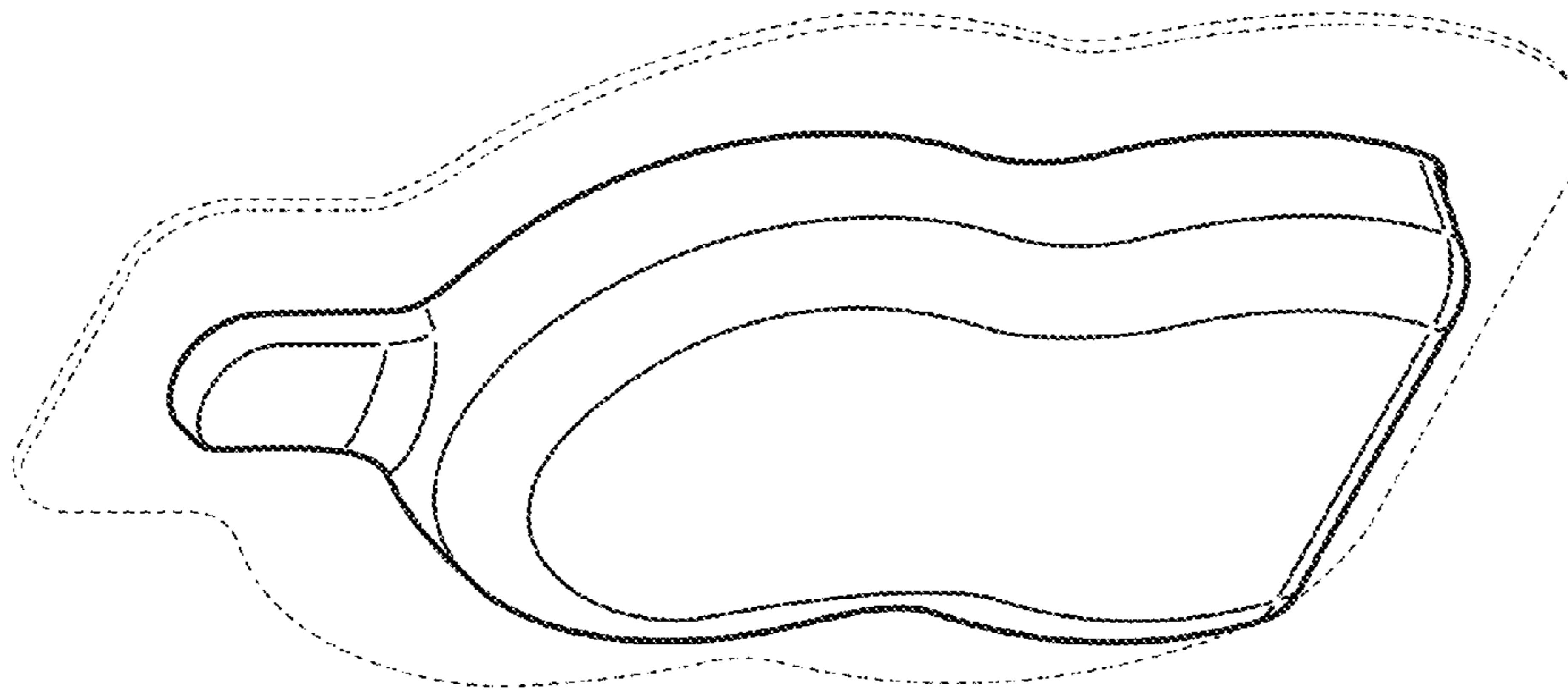

FIG. 1

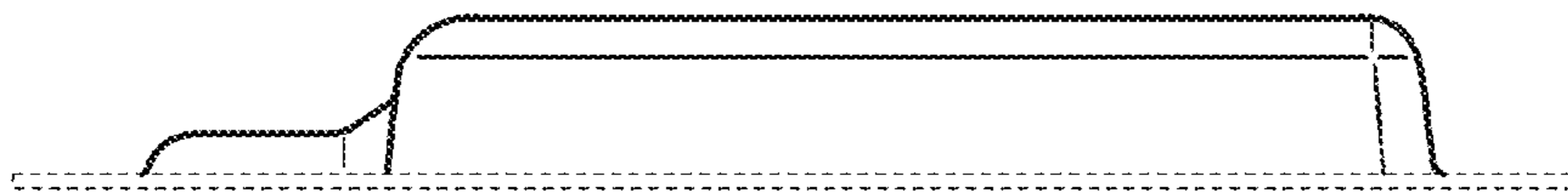

FIG. 2

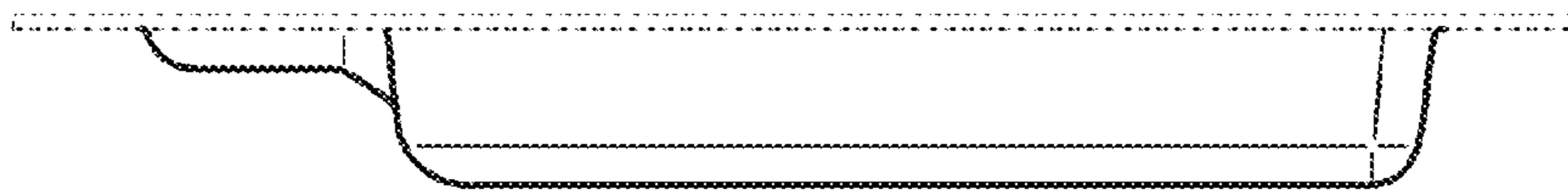

FIG. 3

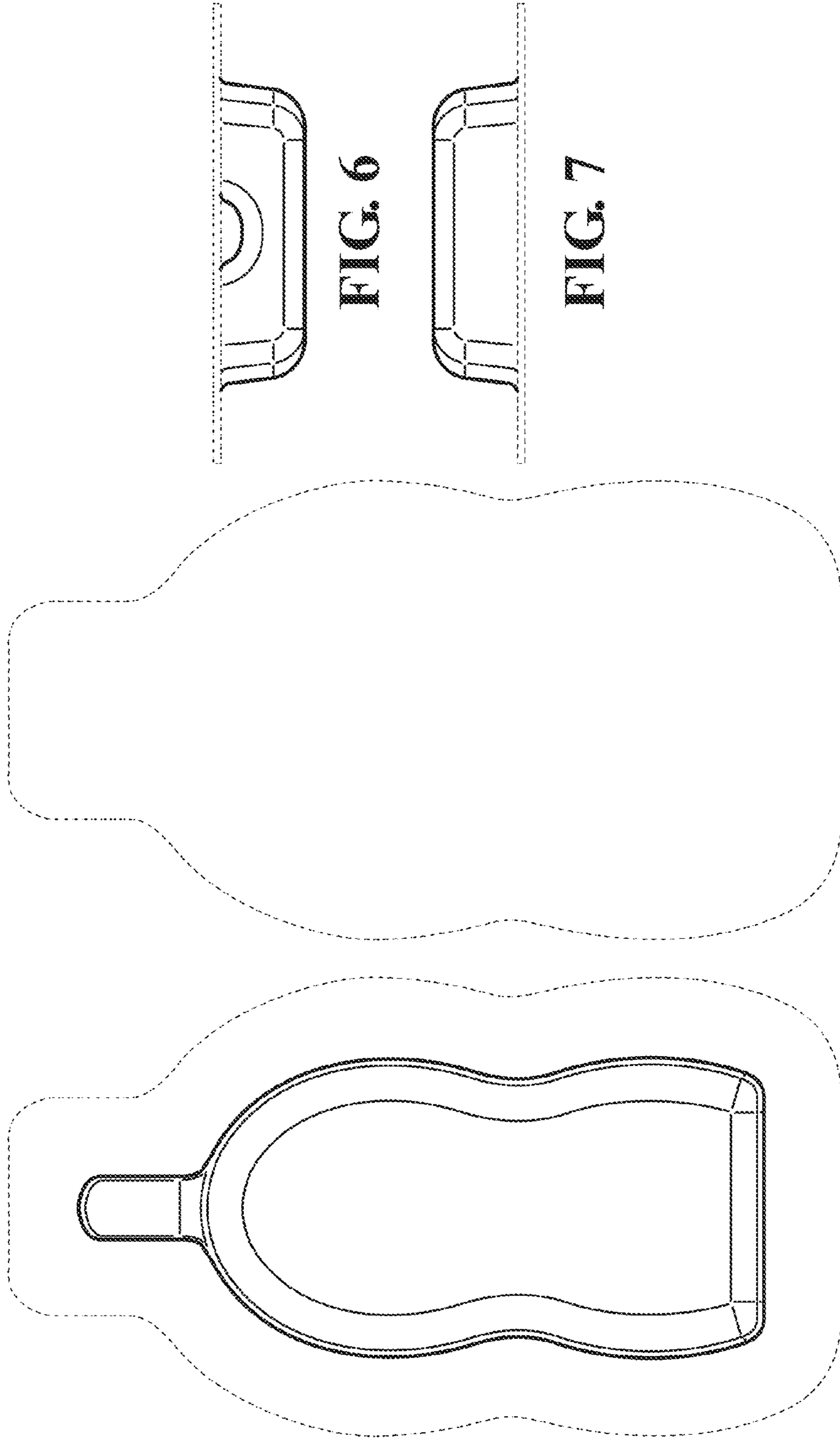

FIG. 4

FIG. 5

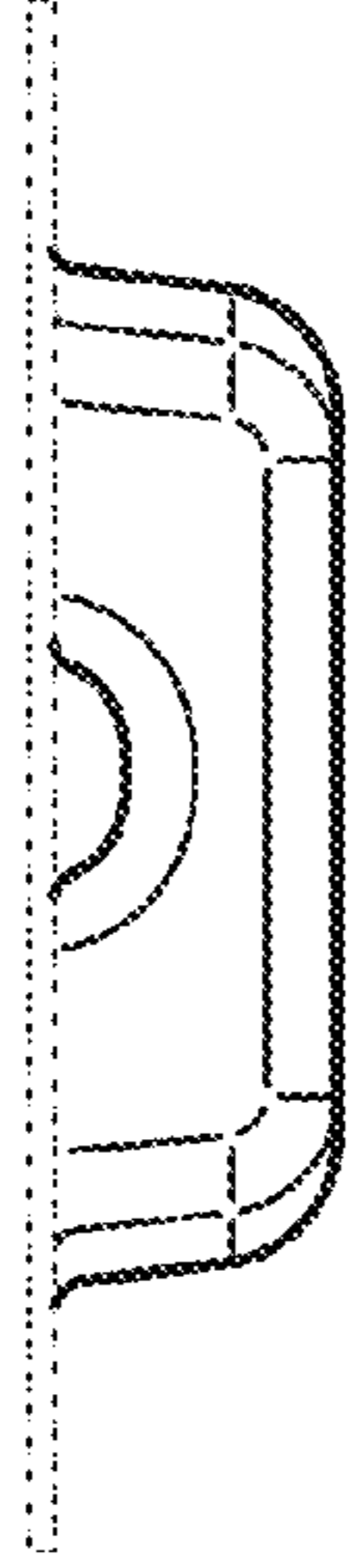

FIG. 6

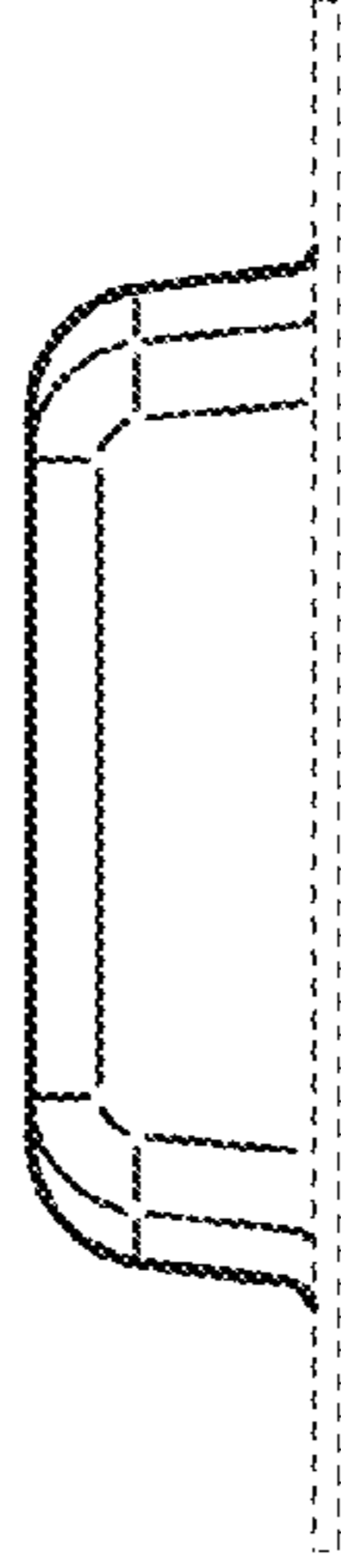

FIG. 7