



US00D765500S

(12) **United States Design Patent** (10) **Patent No.:** **US D765,500 S**
Brown et al. (45) **Date of Patent:** **** Sep. 6, 2016**

(54) **PACKAGE**
(71) Applicant: **KRAFT FOODS R & D, INC.**,
Deerfield, IL (US)
(72) Inventors: **Rosie Brown**, Birmingham (GB);
Julian Sellers, Birmingham (GB); **Glen Dutton**,
Huddersfield (GB)
(73) Assignee: **KRAFT FOODS R&D, INC.**,
Deerfield, IL (US)
(**) Term: **14 Years**
(21) Appl. No.: **29/507,526**
(22) Filed: **Oct. 28, 2014**
(30) **Foreign Application Priority Data**
Apr. 29, 2014 (EM) 002455378-0001
Apr. 29, 2014 (EM) 002455378-0002
Apr. 29, 2014 (EM) 002455378-0003
Apr. 29, 2014 (EM) 002455378-0004
Apr. 29, 2014 (EM) 002455378-0005
Apr. 29, 2014 (EM) 002455378-0006

6,672,762 B1 * 1/2004 Faircloth B65D 5/029
206/278
D517,420 S * 3/2006 Scheider D3/240
D532,967 S * 12/2006 Wong D3/234
D551,967 S * 10/2007 Hengami D9/431
D576,482 S * 9/2008 DeBusk D9/416
D576,888 S * 9/2008 Helfman D9/601
D581,262 S * 11/2008 Suyama D9/415
D617,185 S * 6/2010 Wager D9/431
D617,556 S * 6/2010 Molina D3/282
D622,139 S * 8/2010 Marcott D9/418
D636,220 S * 4/2011 Caldwell D3/308
D637,485 S * 5/2011 Blomberg D9/431
D642,481 S * 8/2011 Proksch D9/731
D661,919 S * 6/2012 Hester D6/407
D672,640 S * 12/2012 Boissinot D9/418
D691,883 S * 10/2013 Thomason D9/432
D693,216 S * 11/2013 Sill D9/418
D701,455 S * 3/2014 Shepherd D9/418
D703,530 S * 4/2014 Caldecourt D9/432
D716,646 S * 11/2014 Ng D9/415
D717,160 S * 11/2014 Kurniawan D9/415
D721,575 S * 1/2015 Paboojian D9/423
D721,597 S * 1/2015 Zumwalt D9/415
D738,172 S * 9/2015 Chen D8/14
D741,702 S * 10/2015 Ruan D9/416
D744,825 S * 12/2015 Johansen D9/418
D746,138 S * 12/2015 Bernstein D9/499
D746,677 S * 1/2016 Candelaria D9/430
D749,964 S * 2/2016 Glass D9/703
D751,378 S * 3/2016 Solovov, Jr. D9/414
D752,969 S * 4/2016 Lv D9/415

(51) **LOC (10) Cl.** **09-03**
(52) **U.S. Cl.**
USPC **D9/415**
(58) **Field of Classification Search**
USPC D9/414-419, 499, 423, 430, 703, 431,
D9/731, 432, 601; D6/407; D3/308, 282,
D3/240, 234; 206/276; D8/14
CPC B65D 5/029
See application file for complete search history.

FOREIGN PATENT DOCUMENTS

EM 0000679540013 9/2004

* cited by examiner

Primary Examiner — Holly Baynham
Assistant Examiner — Rhea Shields
(74) *Attorney, Agent, or Firm* — Cantor Colburn LLP

(56) **References Cited**
U.S. PATENT DOCUMENTS
D278,596 S * 4/1985 Ceraulo D9/415
D292,487 S * 10/1987 Kea D9/432
D306,829 S * 3/1990 Golkar D9/415
D307,719 S * 5/1990 Band D9/418
D460,355 S * 7/2002 Lenz D9/418
D469,687 S * 2/2003 Larian D9/415

(57) **CLAIM**
The ornamental design for a package, as shown and described.

DESCRIPTION

FIG. 1 is a perspective view of a first embodiment of the package; showing our new design;

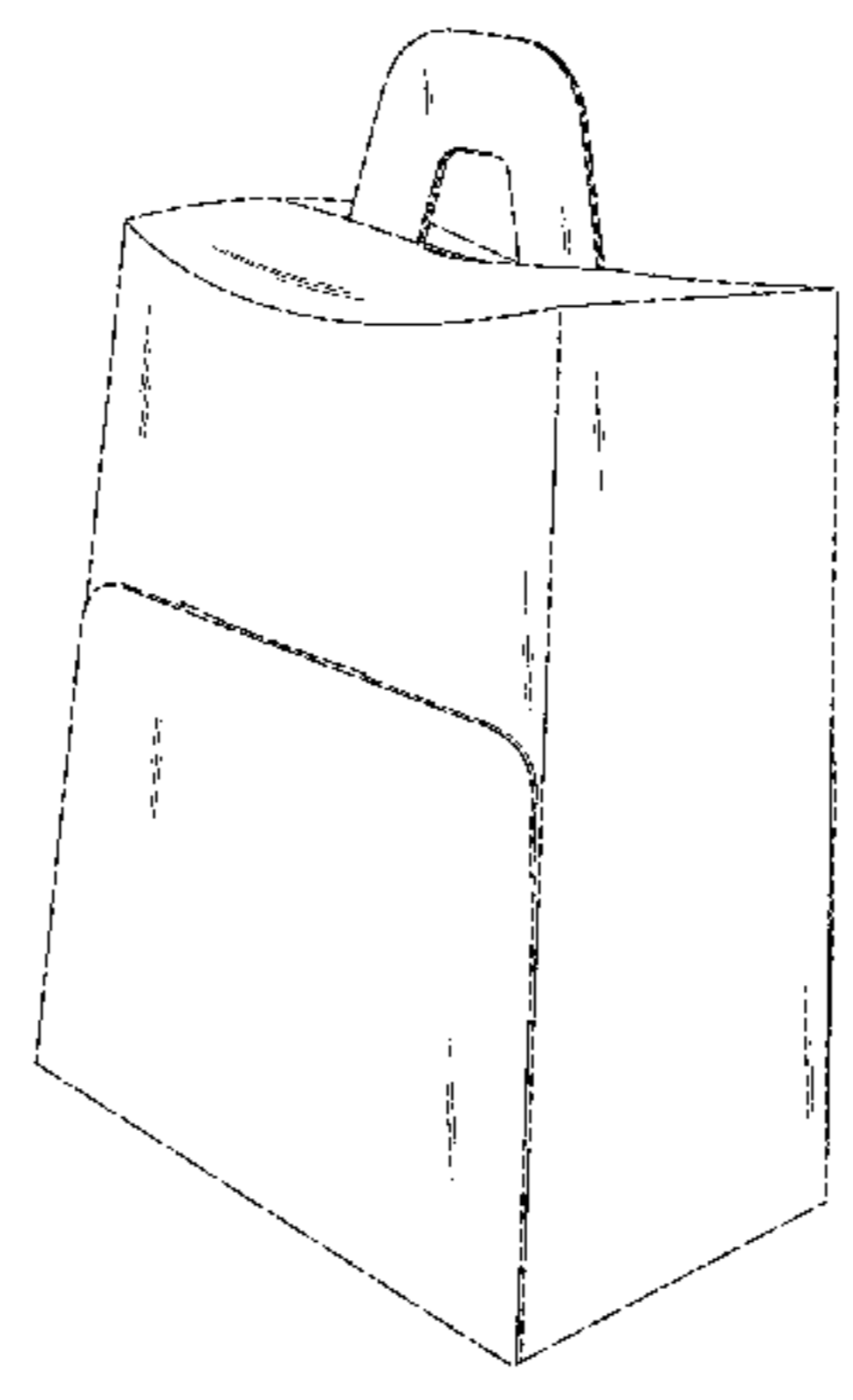

FIG. 2 is a rear perspective view thereof;
FIG. 3 is a front view thereof;
FIG. 4 is a rear view thereof;
FIG. 5 is a side view thereof;
FIG. 6 is another side view thereof;
FIG. 7 is a top plan view thereof, and;
FIG. 8 is a bottom plan view thereof;
FIG. 9 is a perspective view of the package shown in FIG. 1 with the front and rear flaps in an open state;
FIG. 10 is a front view thereof;
FIG. 11 is a rear view thereof;
FIG. 12 is a side view thereof;
FIG. 13 is another side view thereof;
FIG. 14 is a top plan view thereof, and;
FIG. 15 is a bottom plan view thereof;
FIG. 16 is a perspective view of a second embodiment of the package;
FIG. 17 is a rear perspective view thereof;
FIG. 18 is a front view thereof;
FIG. 19 is a rear view thereof;
FIG. 20 is a side view thereof;
FIG. 21 is another side view thereof;
FIG. 22 is a top plan view thereof, and;
FIG. 23 is a bottom plan view thereof;

FIG. 24 is a perspective view of the package shown in FIG. 16 with the front and rear flaps in an open state;
FIG. 25 is a front view thereof;
FIG. 26 is a rear view thereof;
FIG. 27 is a side view thereof;
FIG. 28 is another side view thereof;
FIG. 29 is a top plan view thereof, and;
FIG. 30 is a bottom plan view thereof.
FIG. 31 is a perspective view of the package shown in FIG. 1 with the top flaps in an open state;
FIG. 32 is a front view thereof;
FIG. 33 is a rear view thereof;
FIG. 34 is a side view thereof;
FIG. 35 is another side view thereof;
FIG. 36 is a top plan view thereof, and;
FIG. 37 is a bottom plan view thereof.
FIG. 38 is a rear perspective view of the package shown in FIG. 1 with the top and rear flaps in an open state; and,
FIG. 39 is a top plan view thereof showing the package in a blank configuration.
In the drawings, the broken lines are for the purpose of illustrating environment only and form no part of the claimed design.

1 Claim, 36 Drawing Sheets

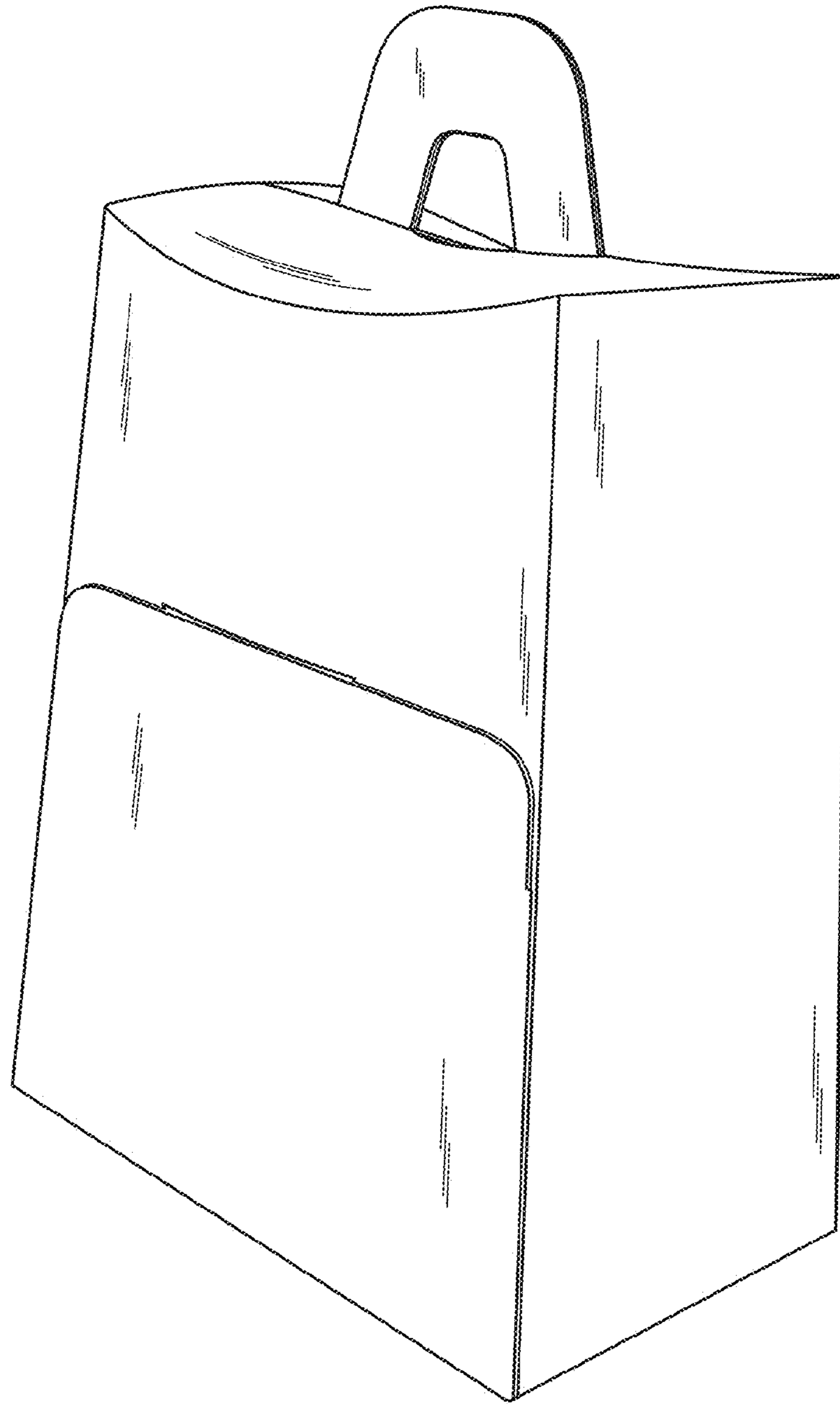

FIG. 1

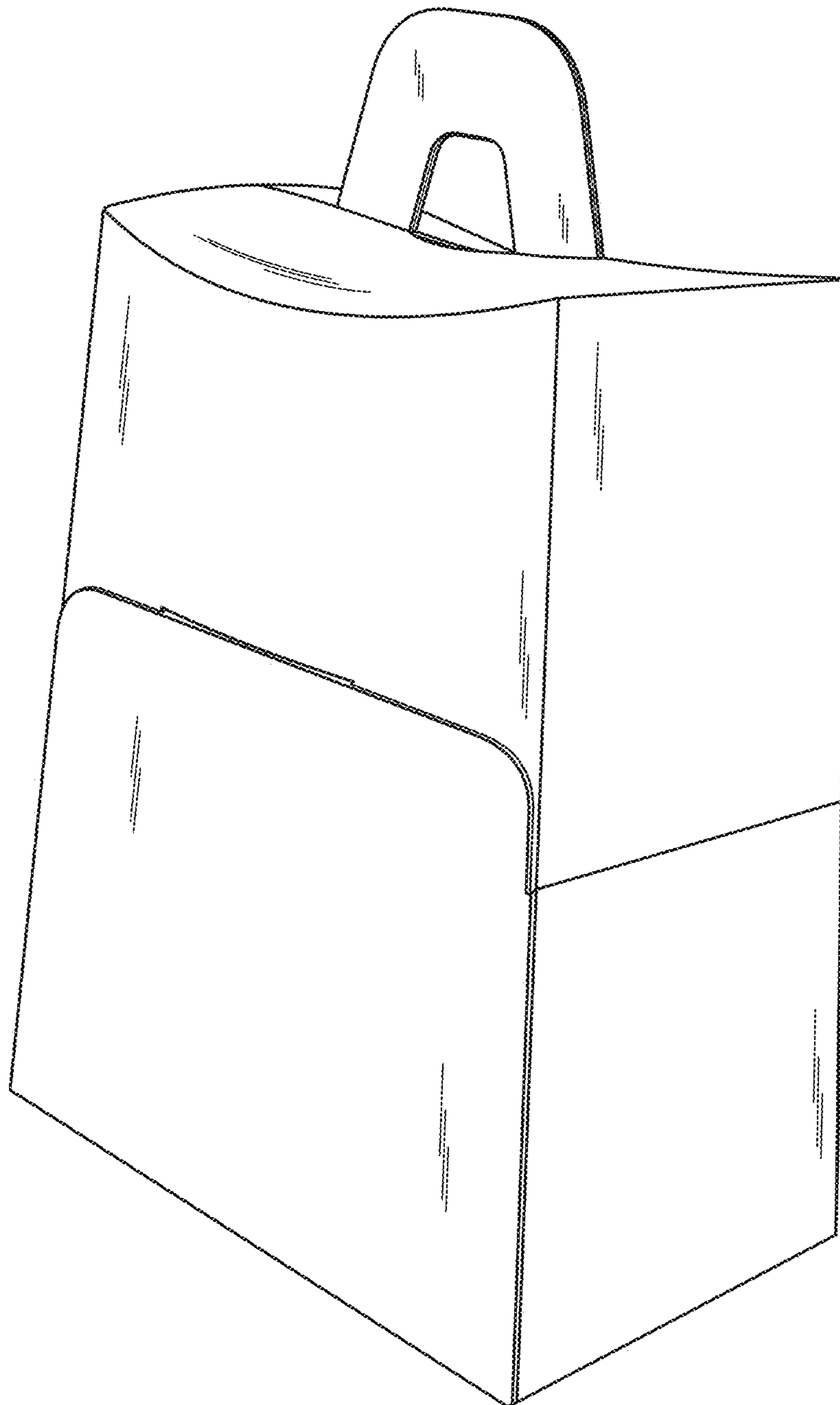

FIG. 2

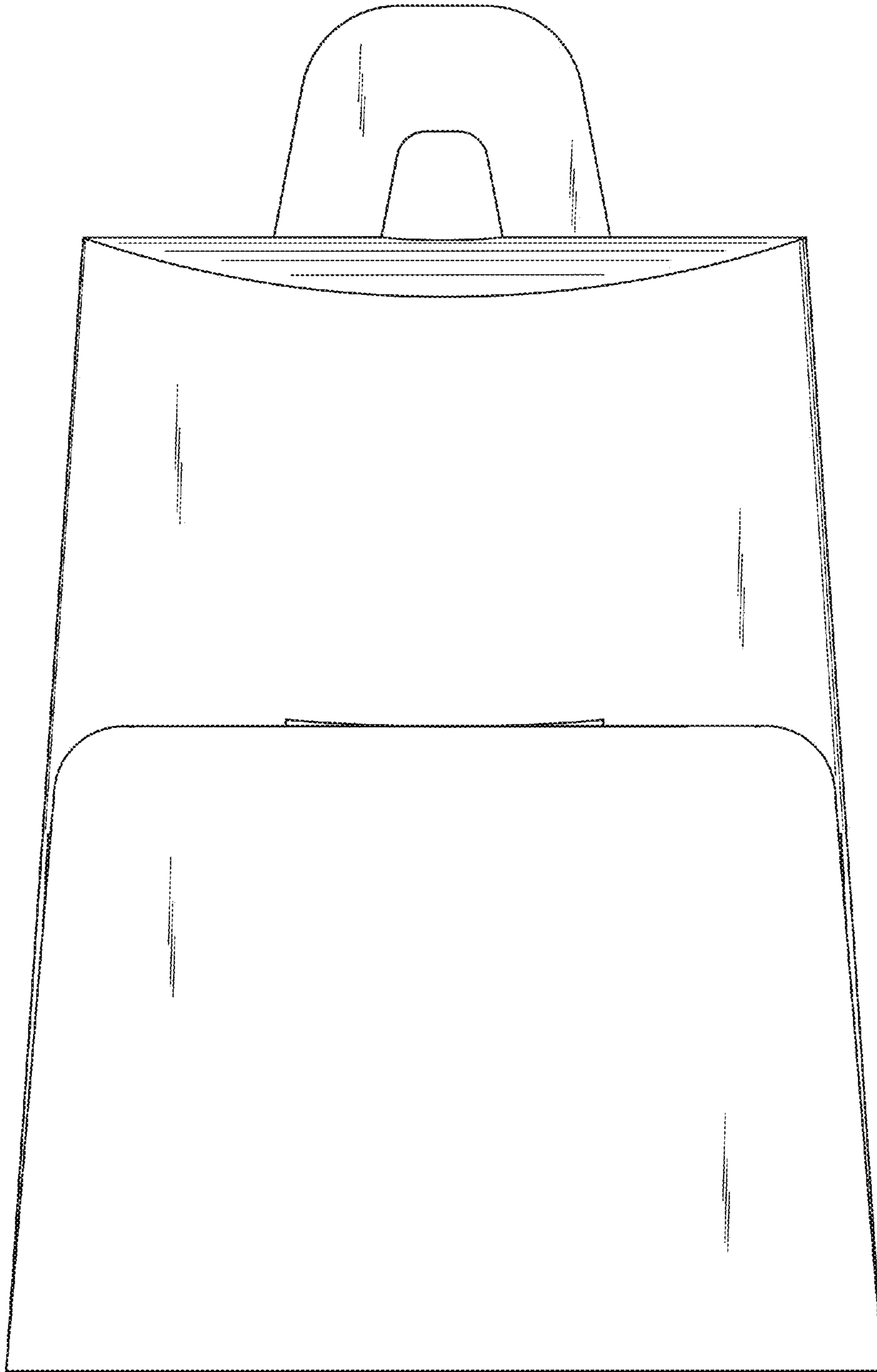

FIG. 3

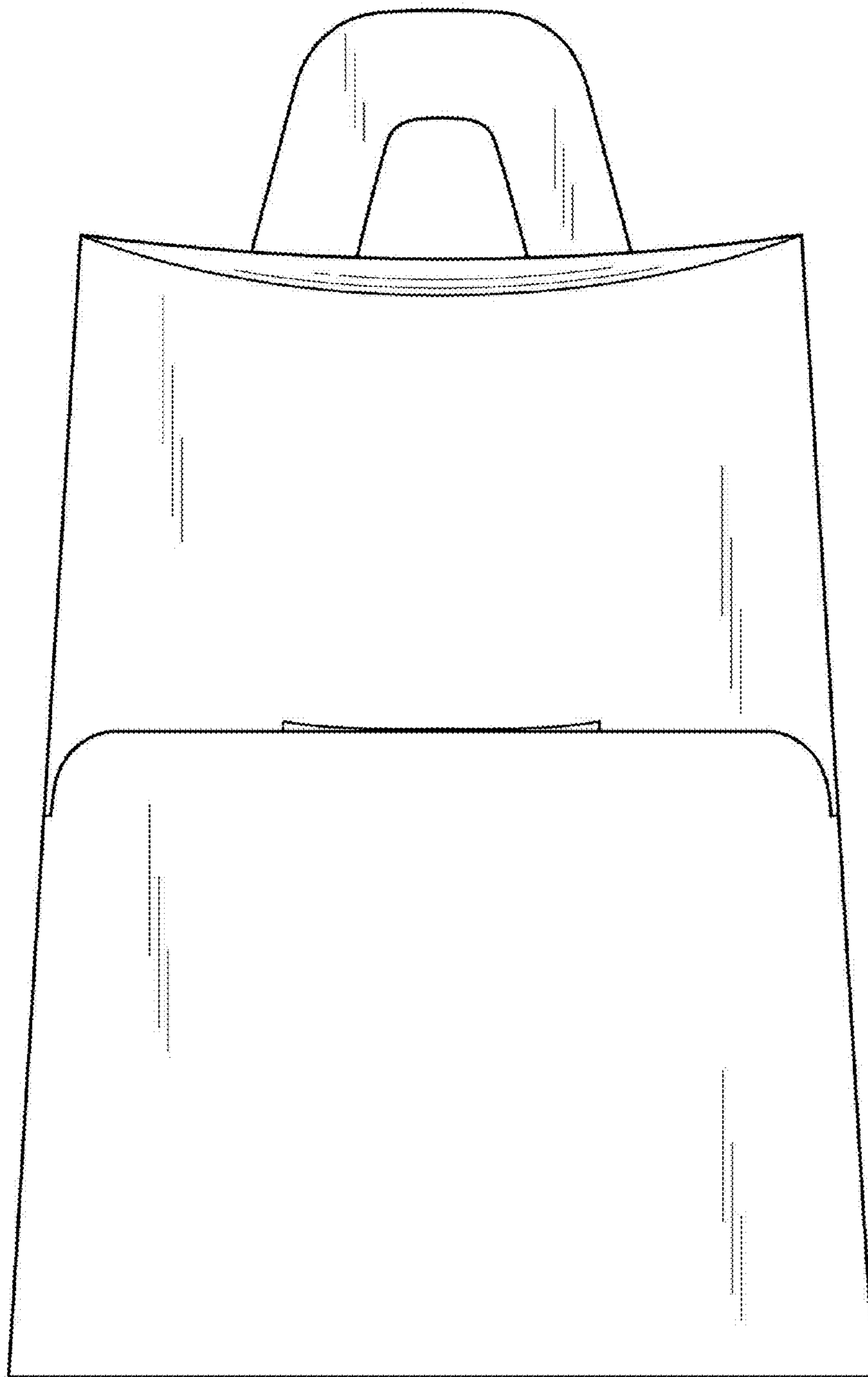

FIG. 4

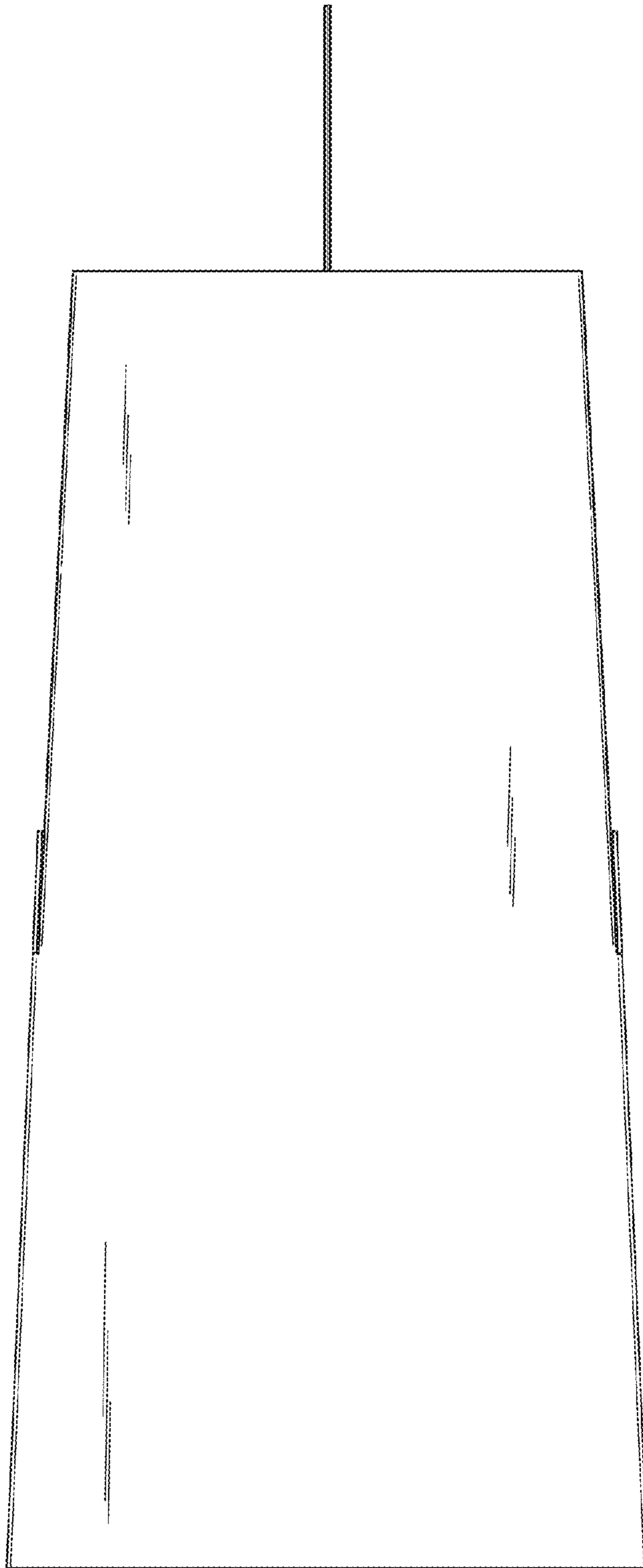

FIG. 5

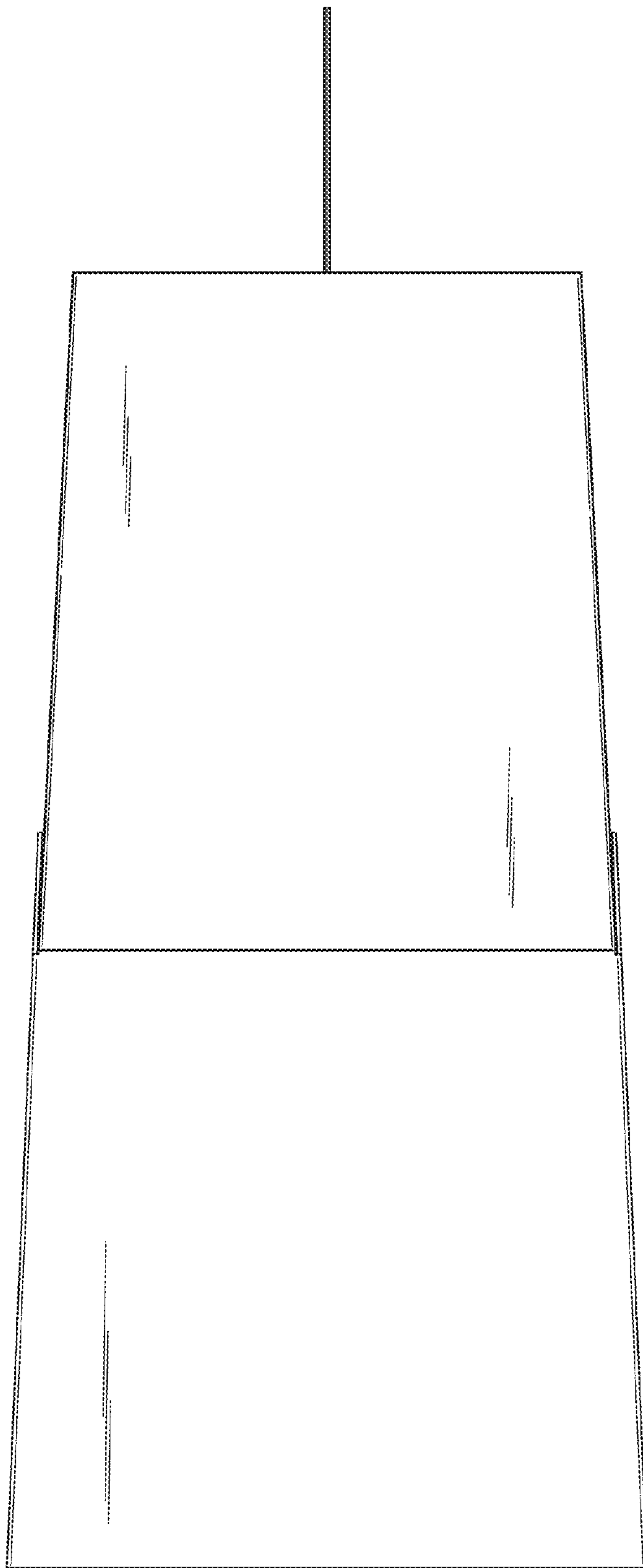

FIG. 6

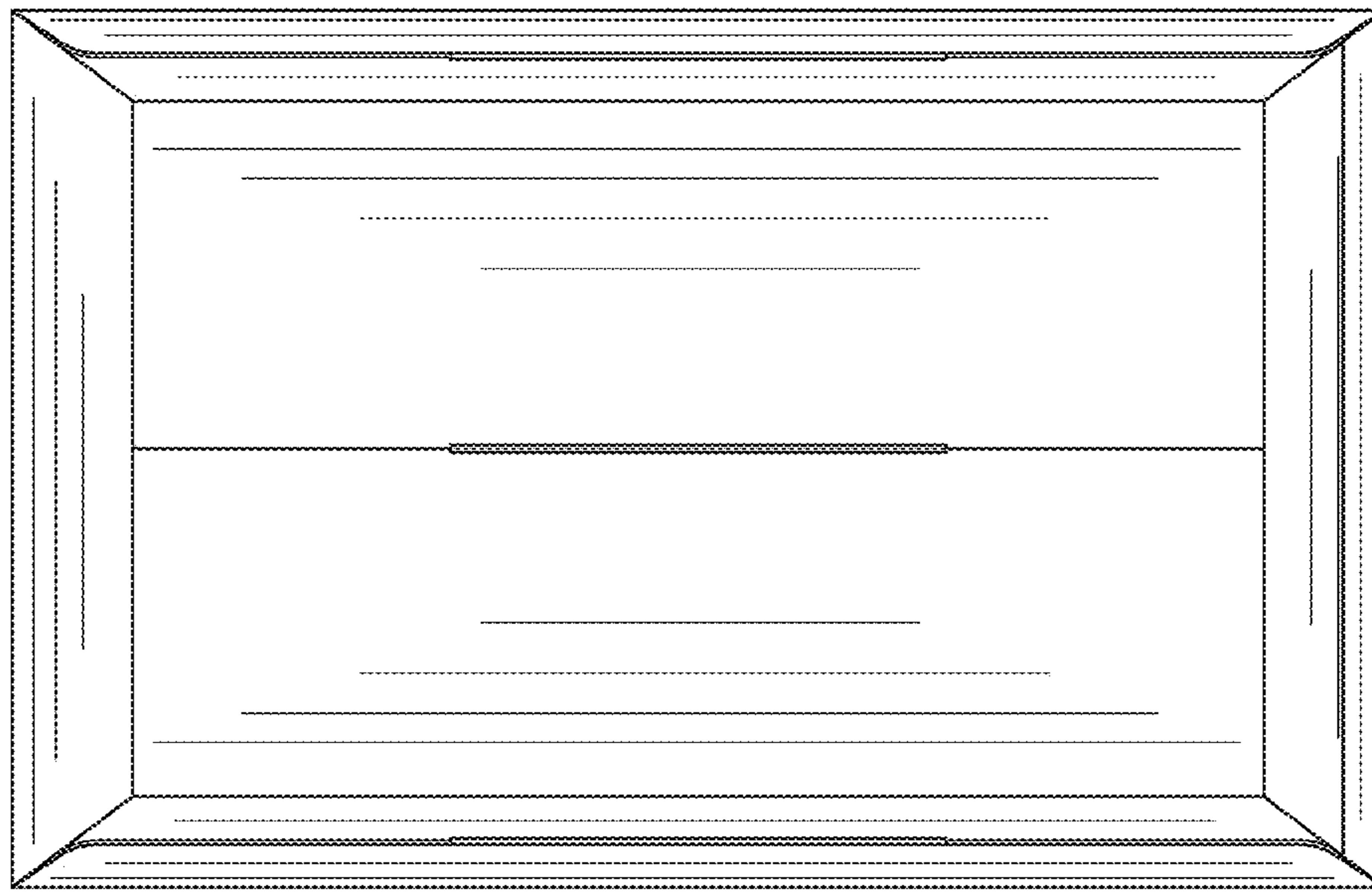

FIG. 7

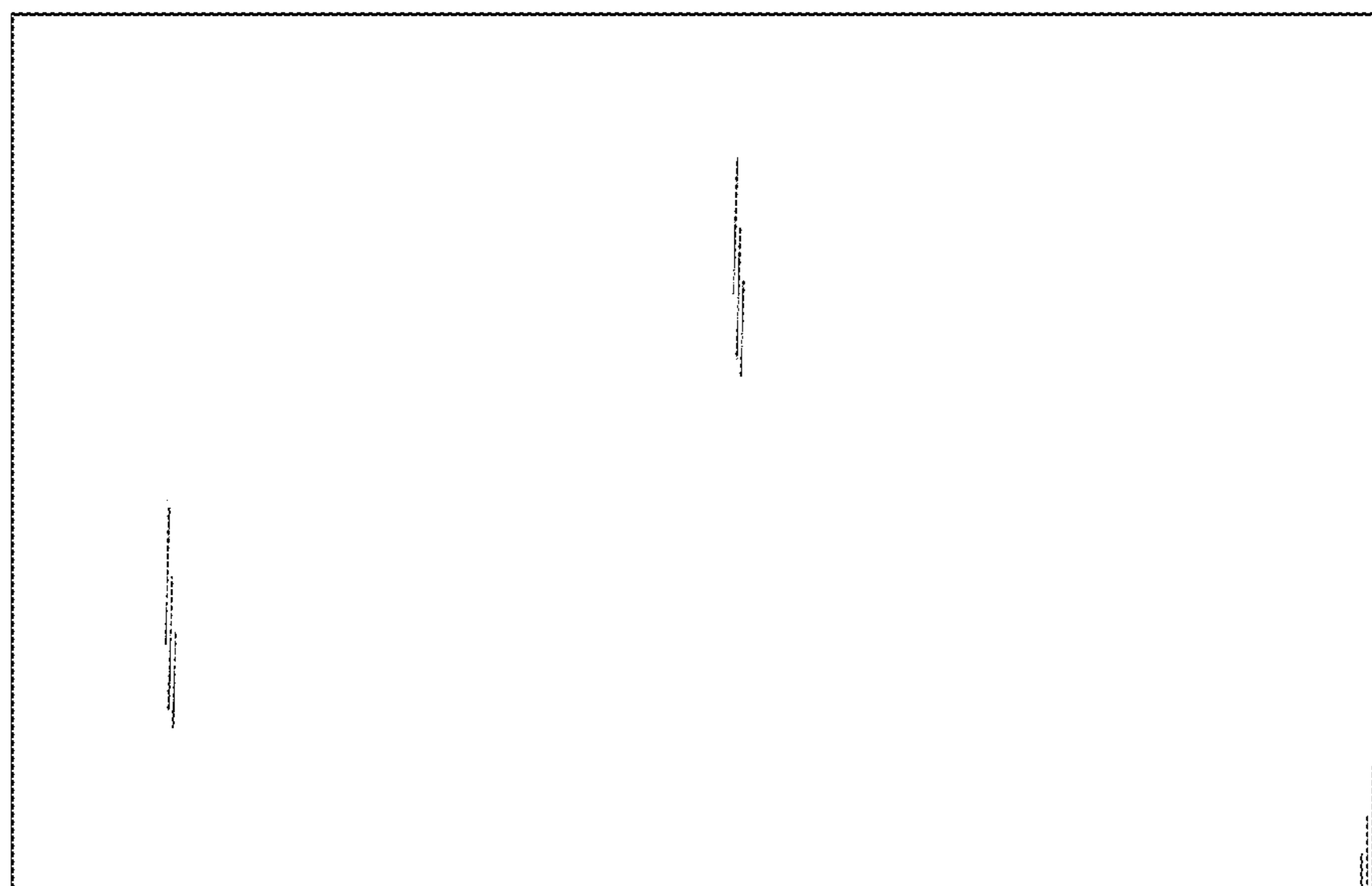

FIG. 8

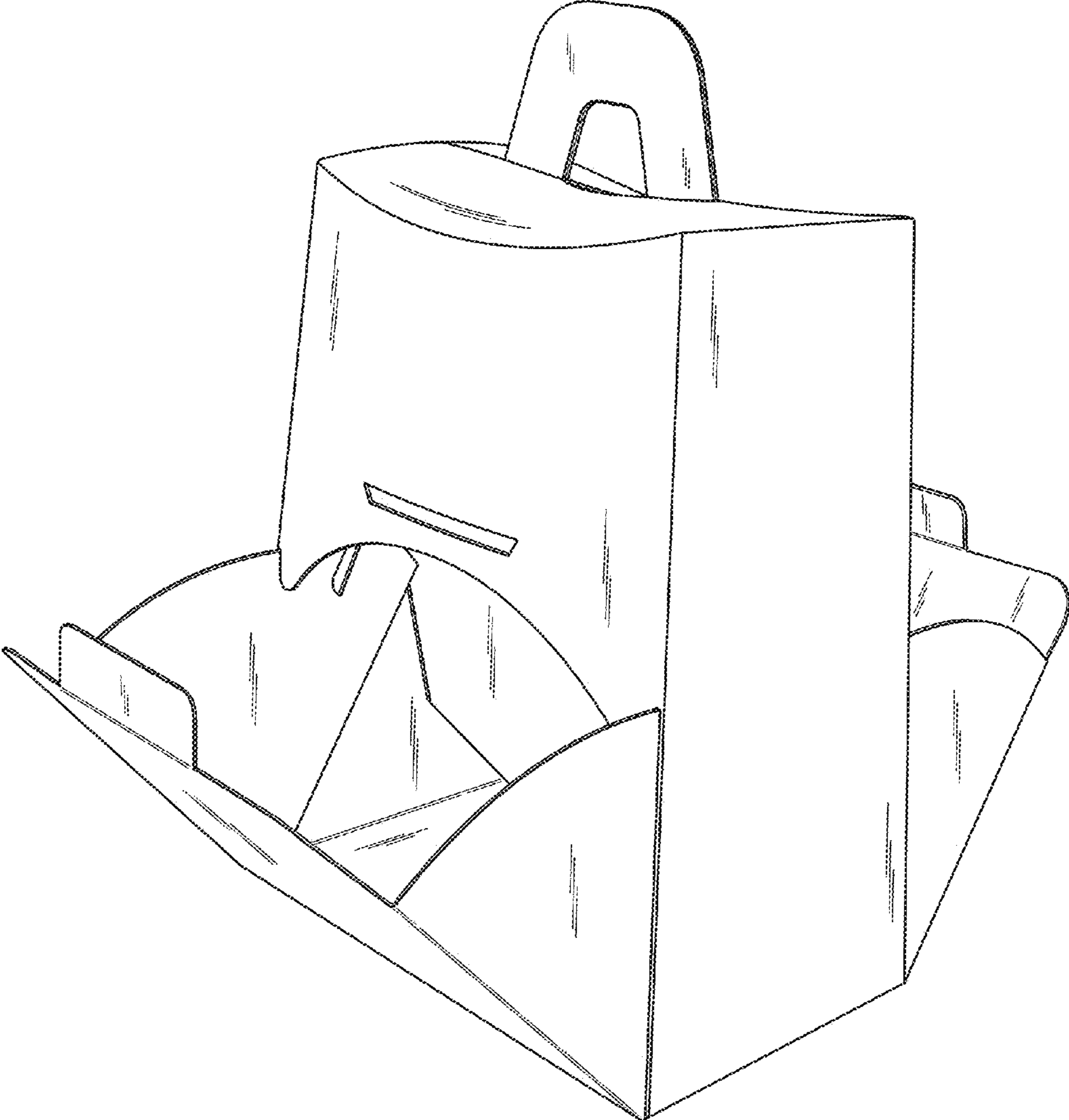

FIG. 9

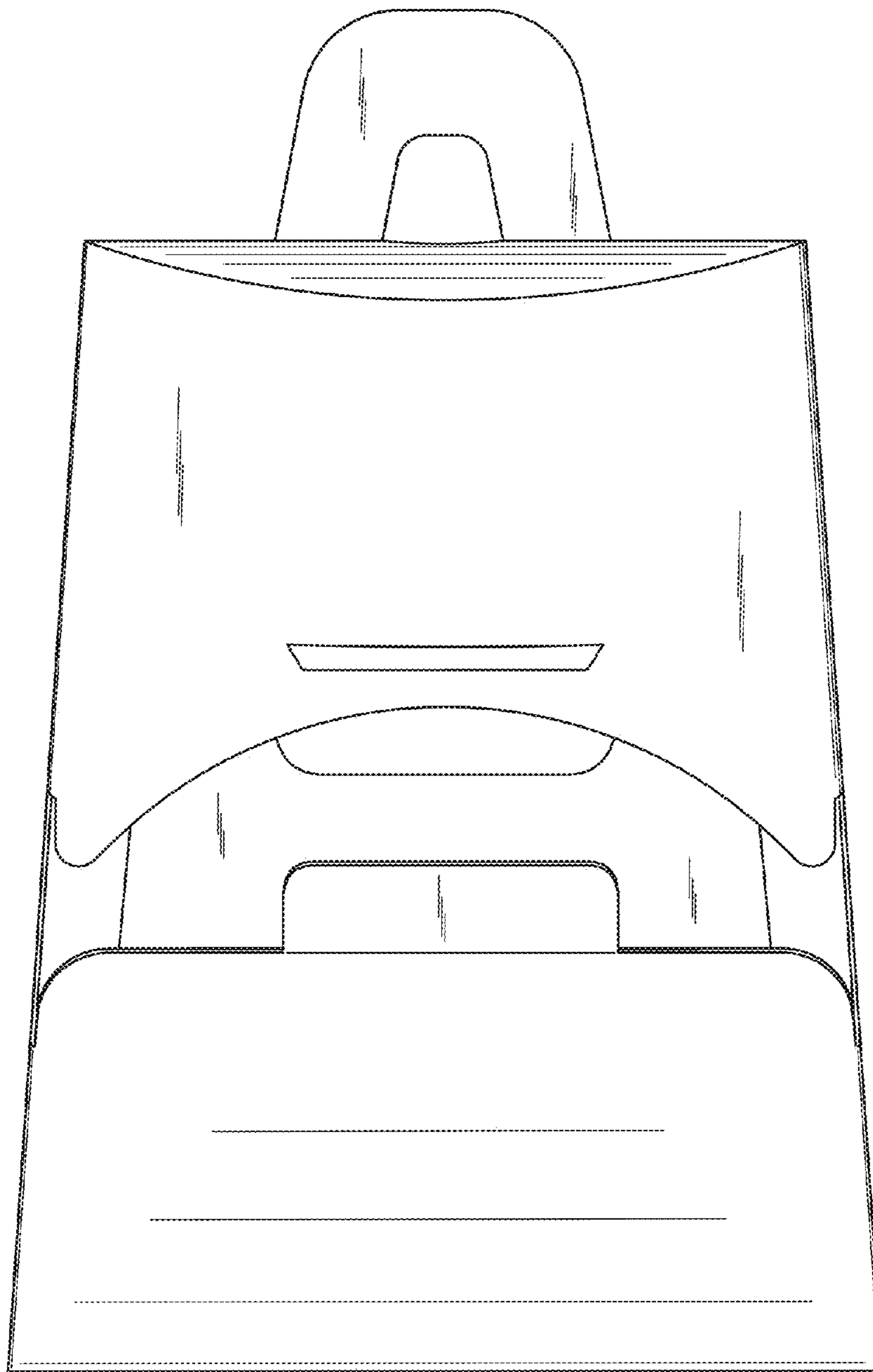

FIG. 10

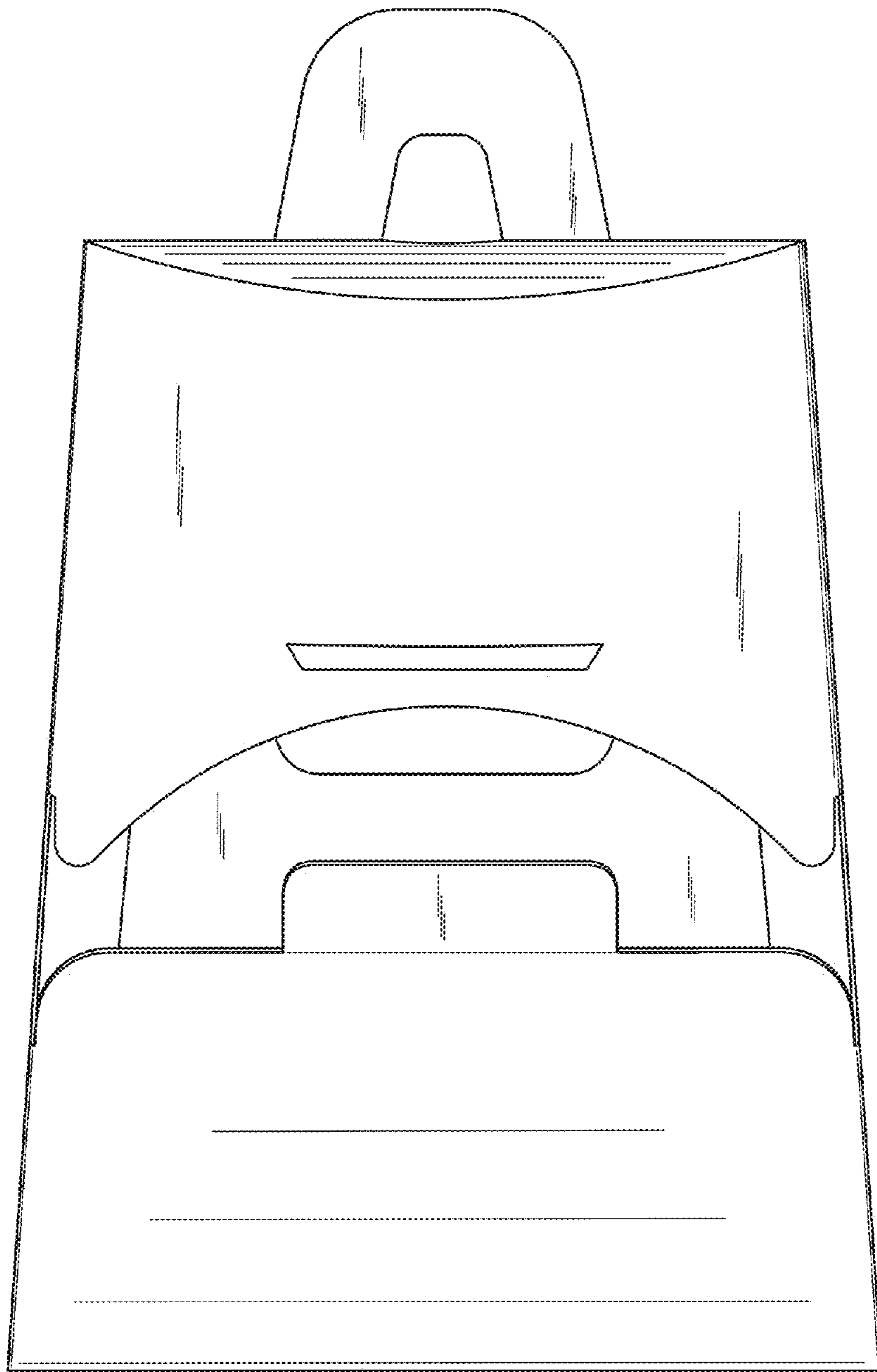

FIG. 11

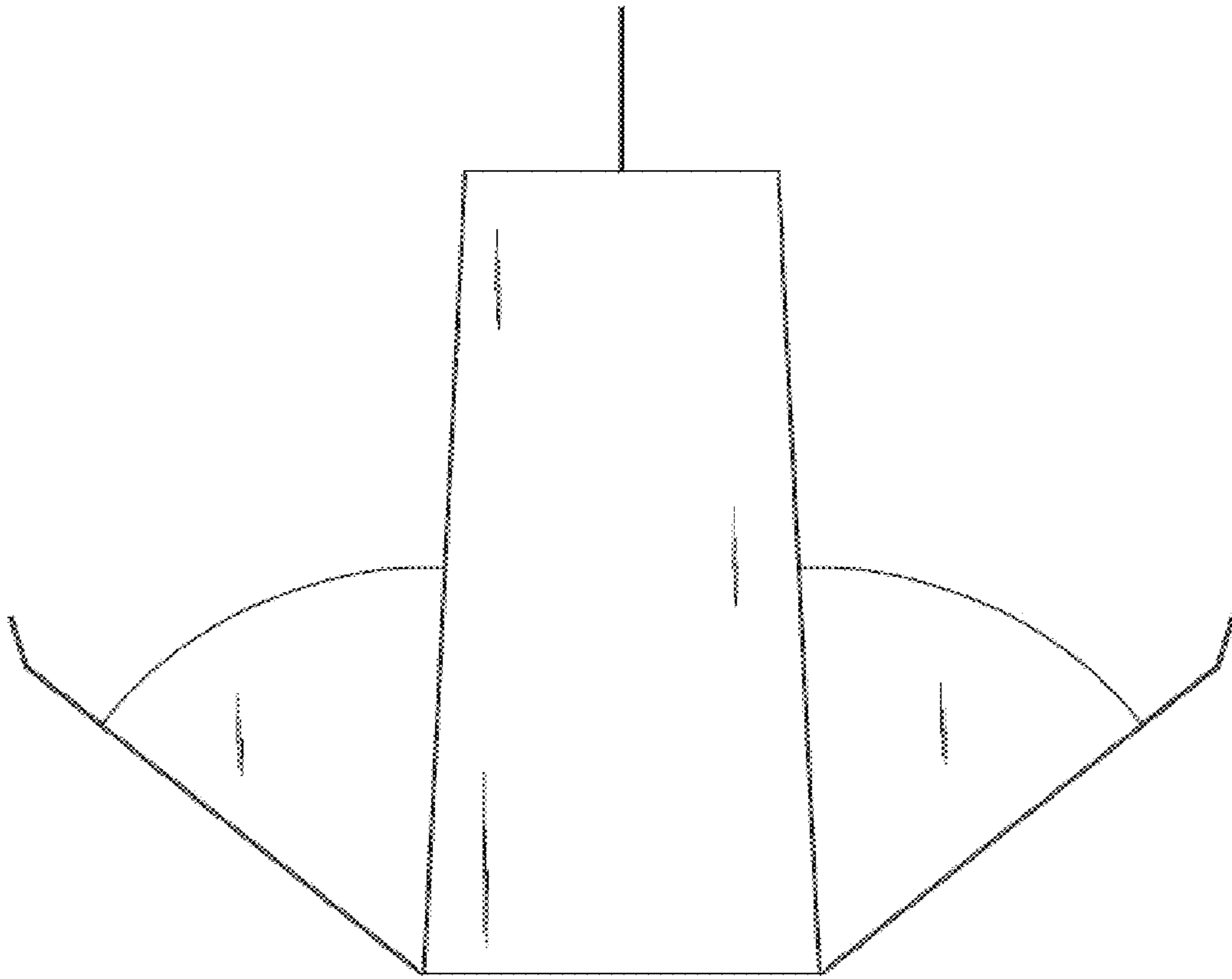

FIG. 12

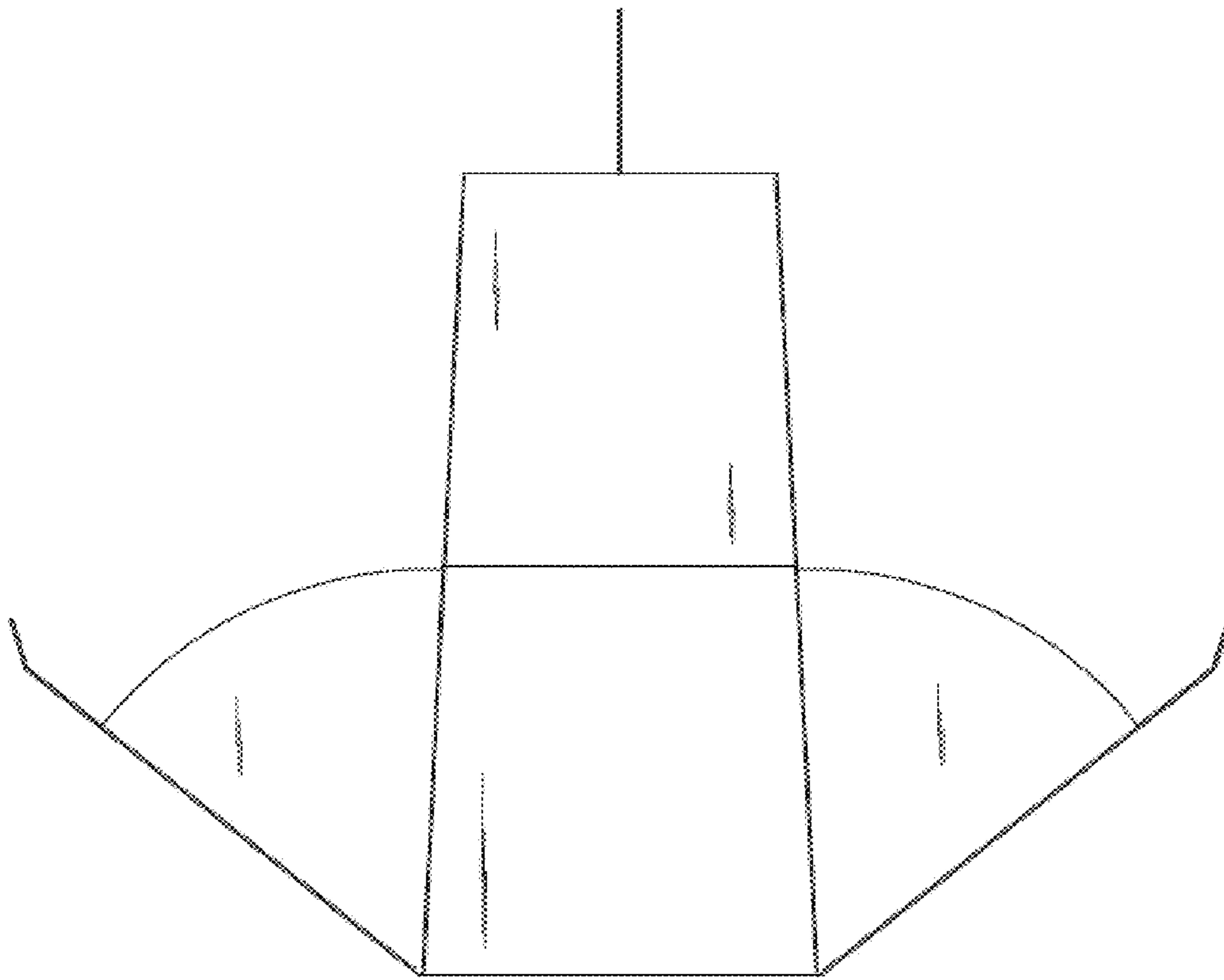

FIG. 13



FIG. 14

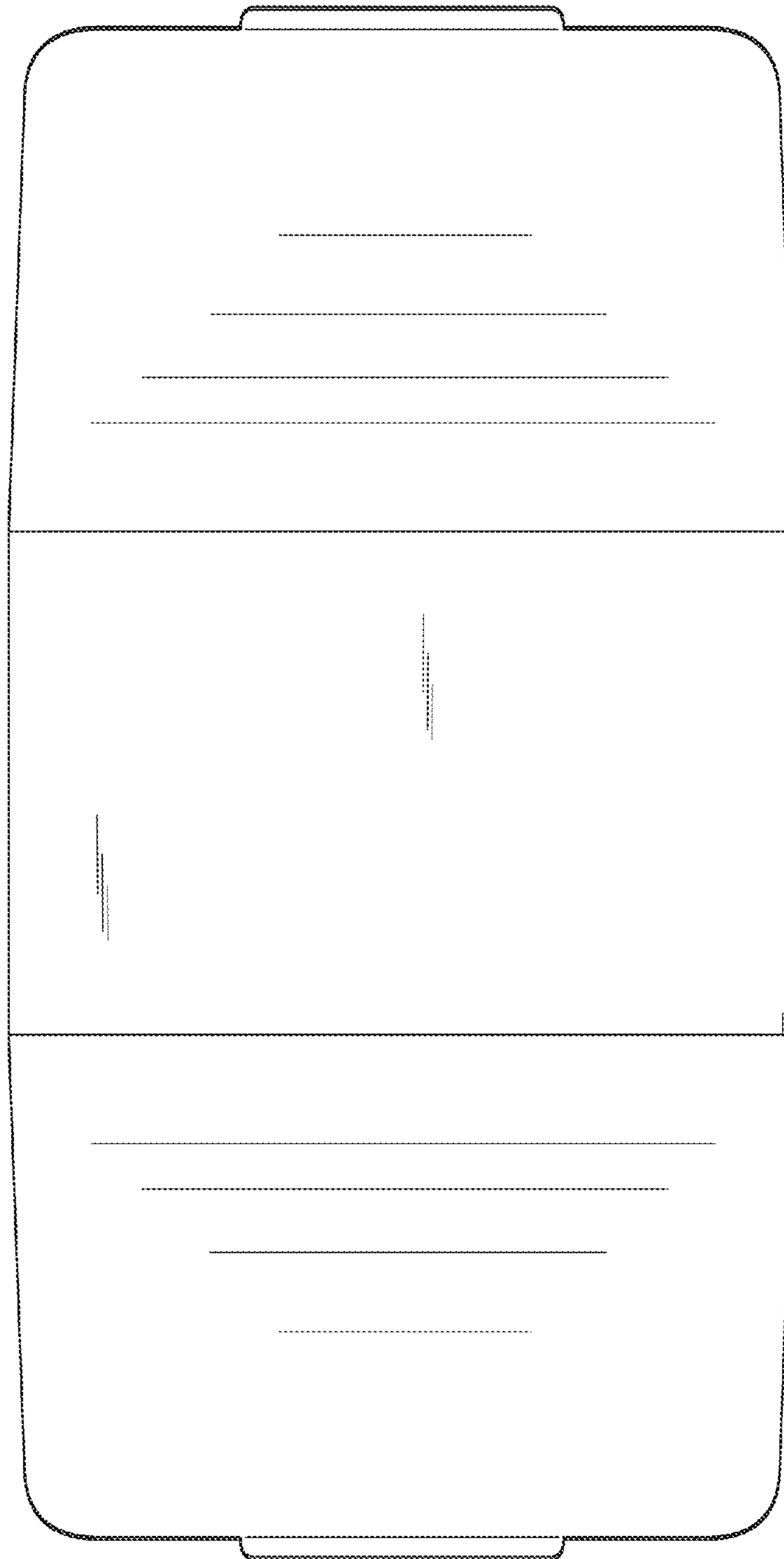

FIG. 15

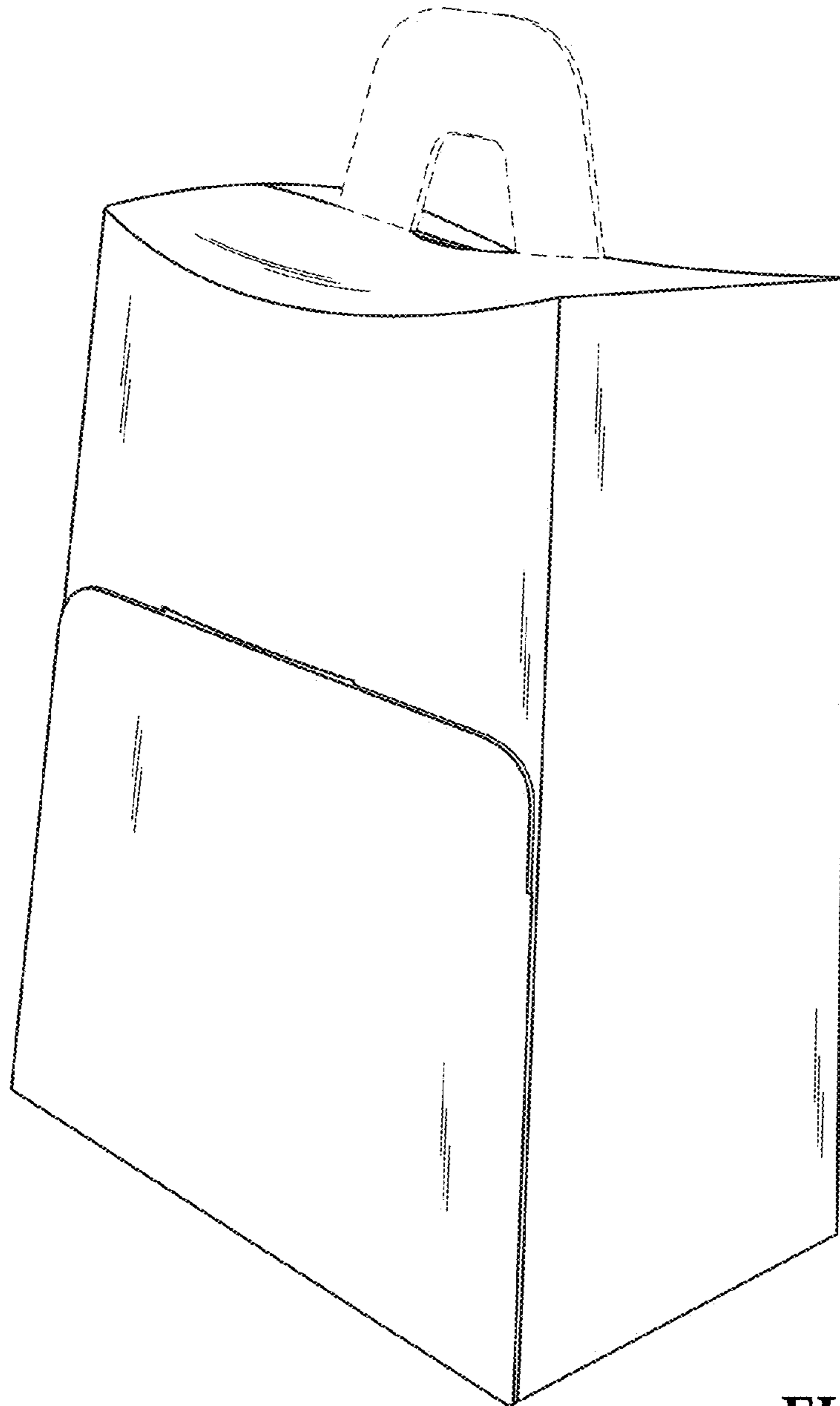

FIG. 16

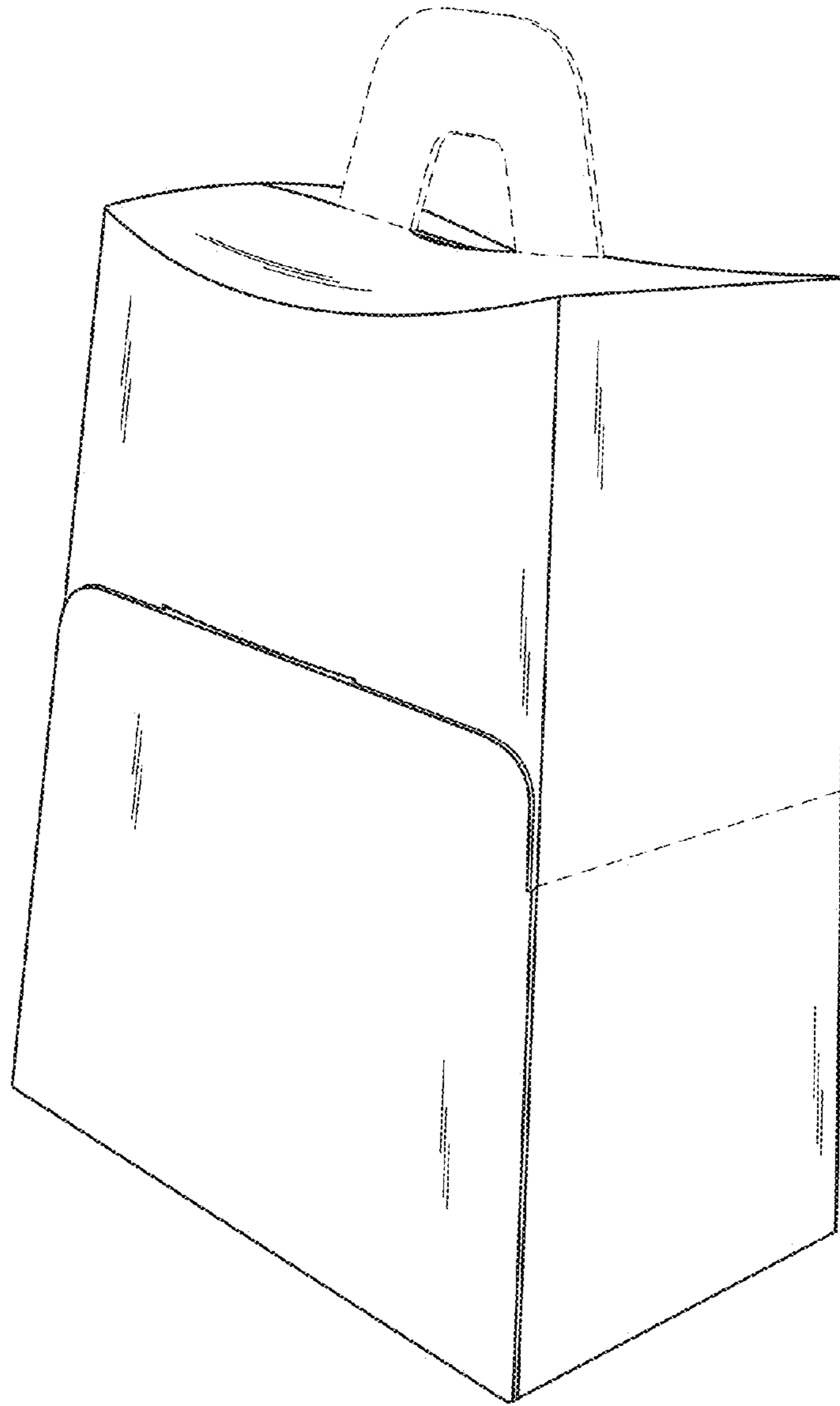

FIG. 17

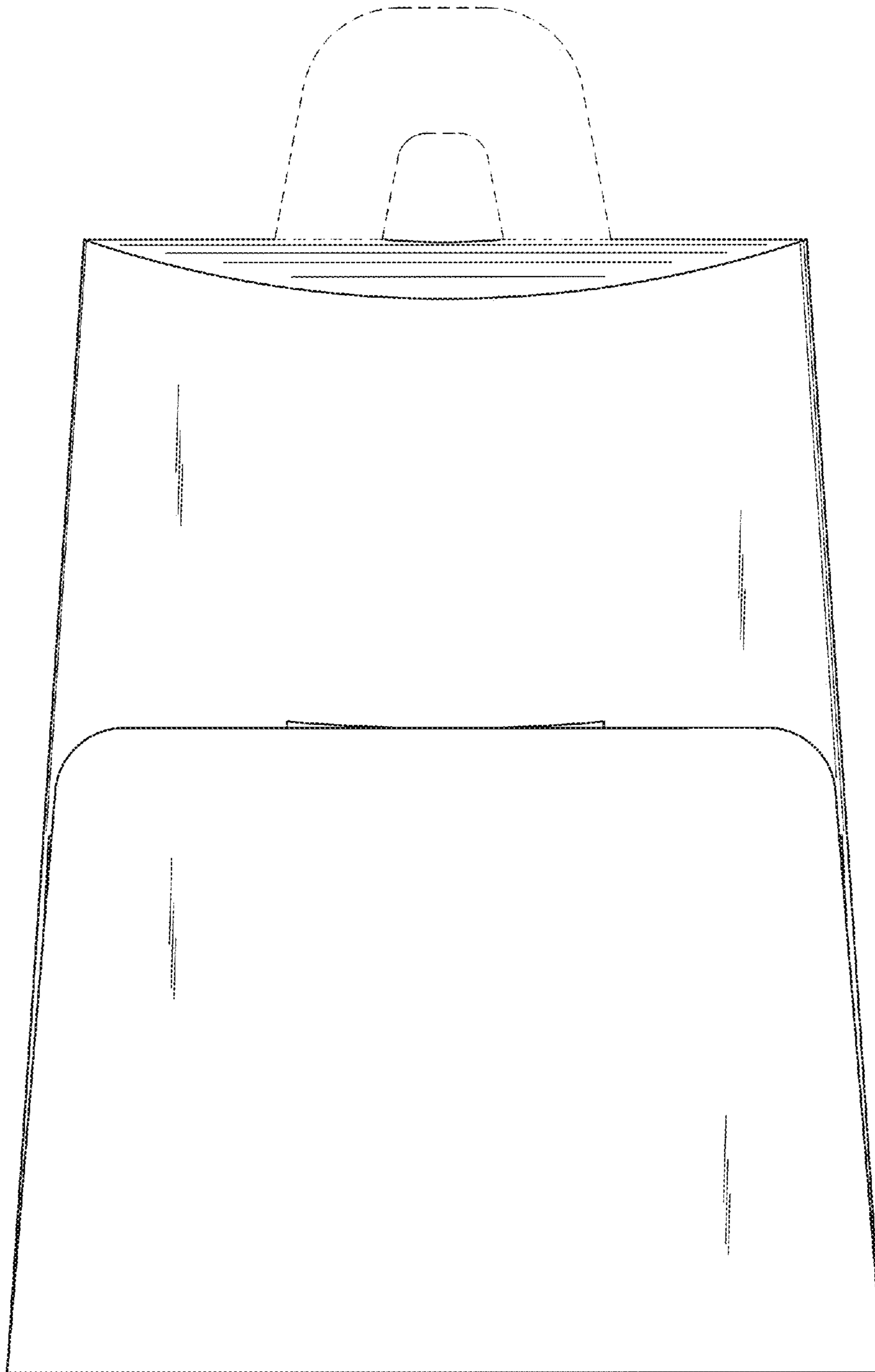

FIG. 18

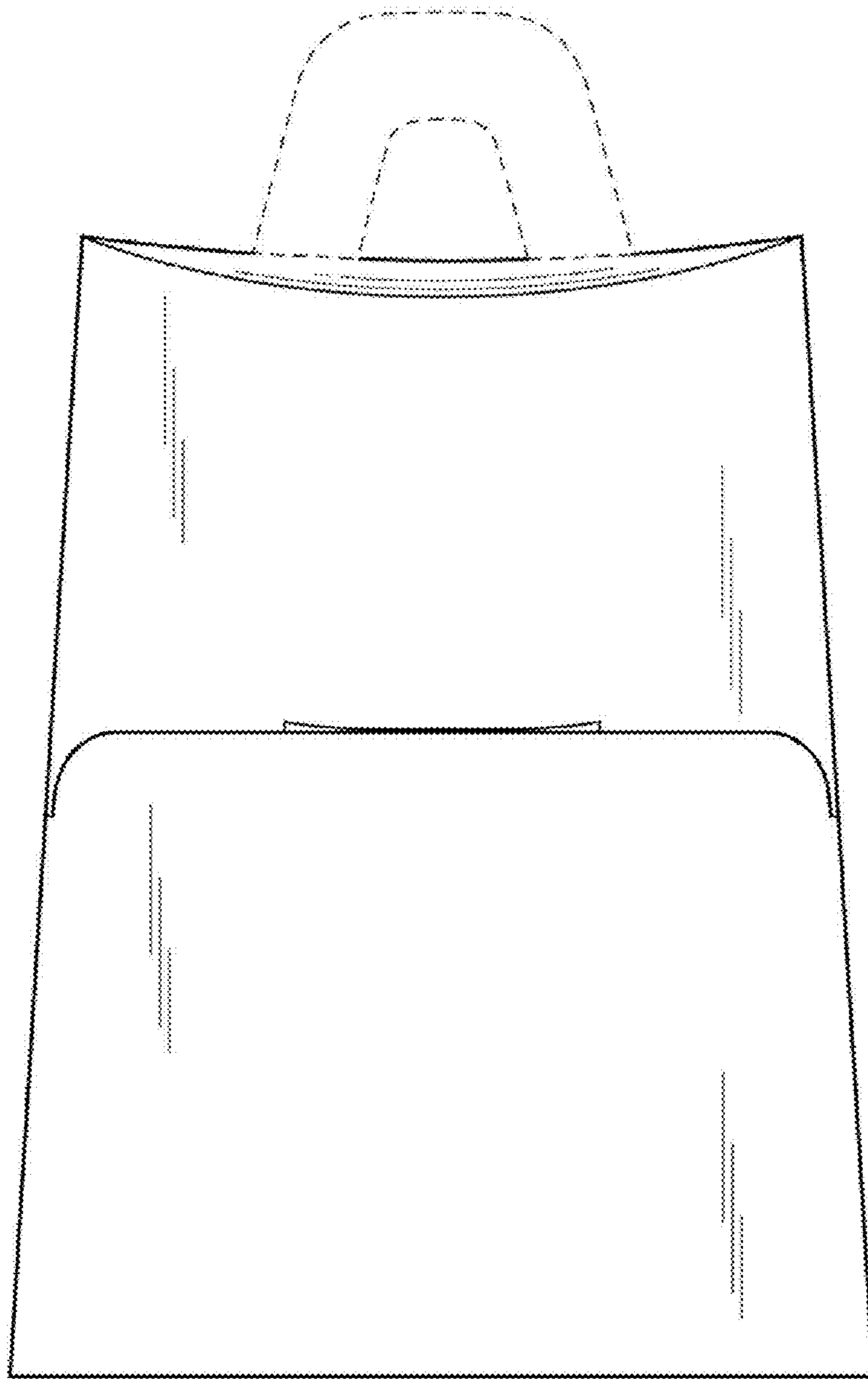

FIG. 19

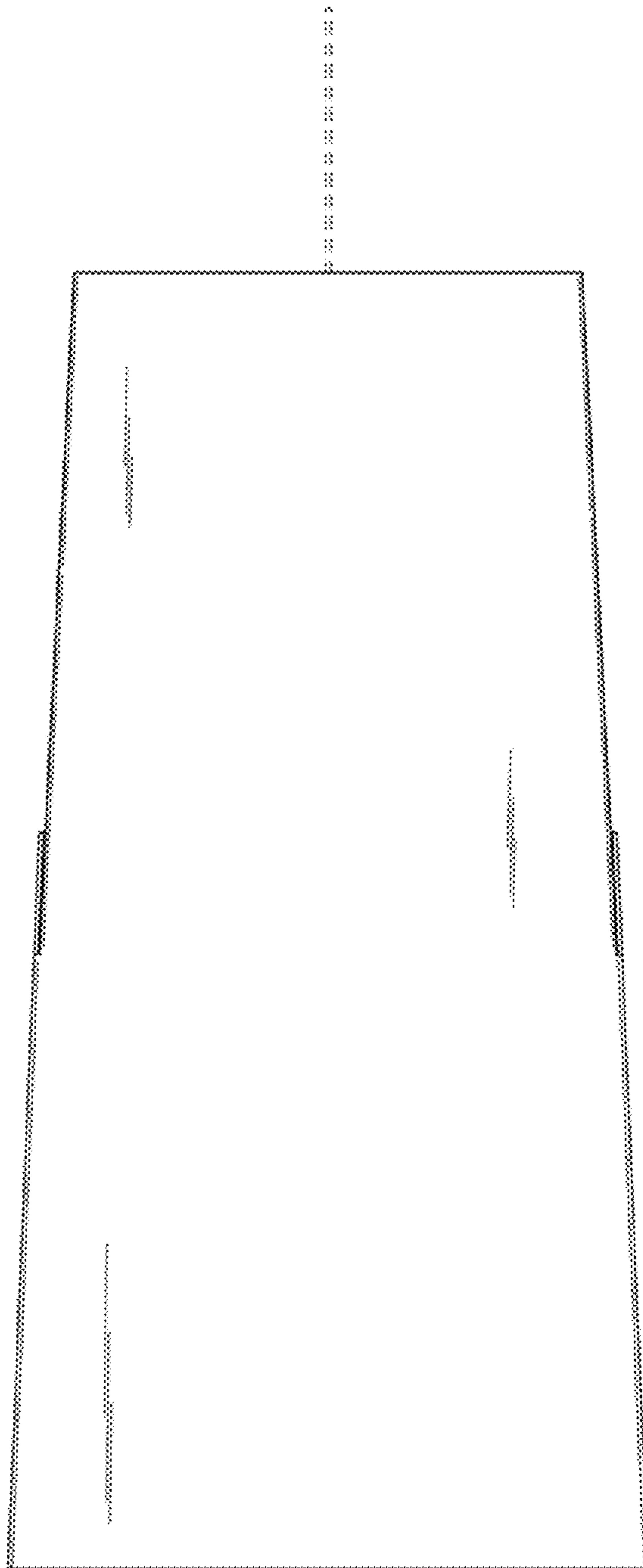

FIG. 20

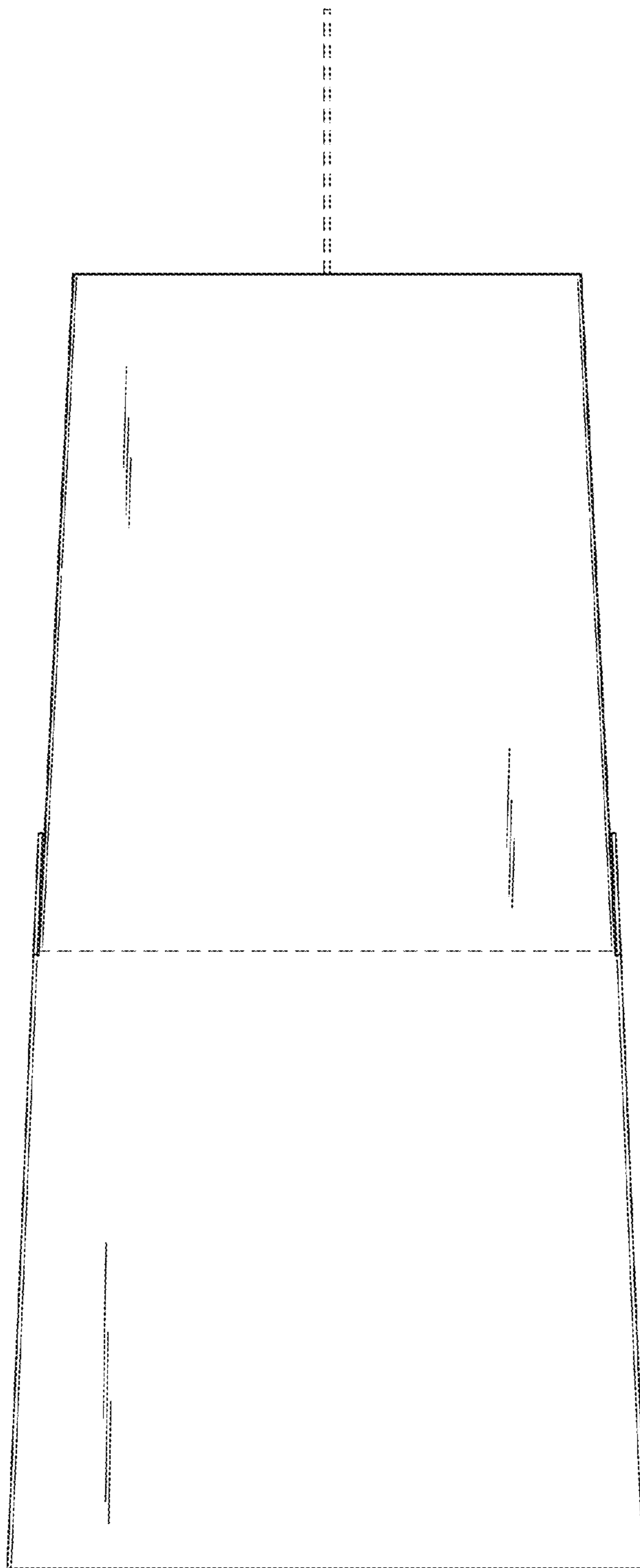

FIG. 21

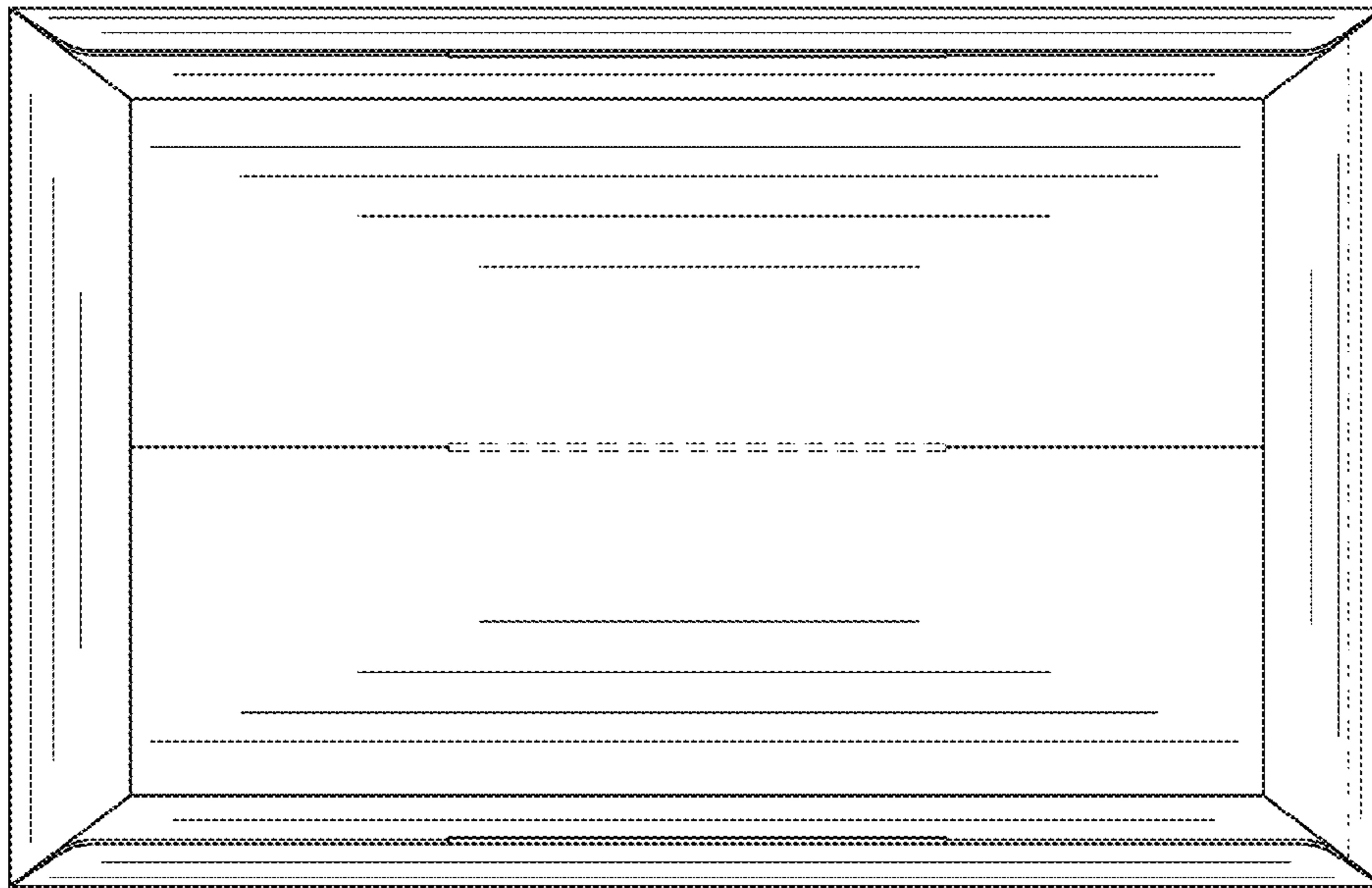

FIG. 22

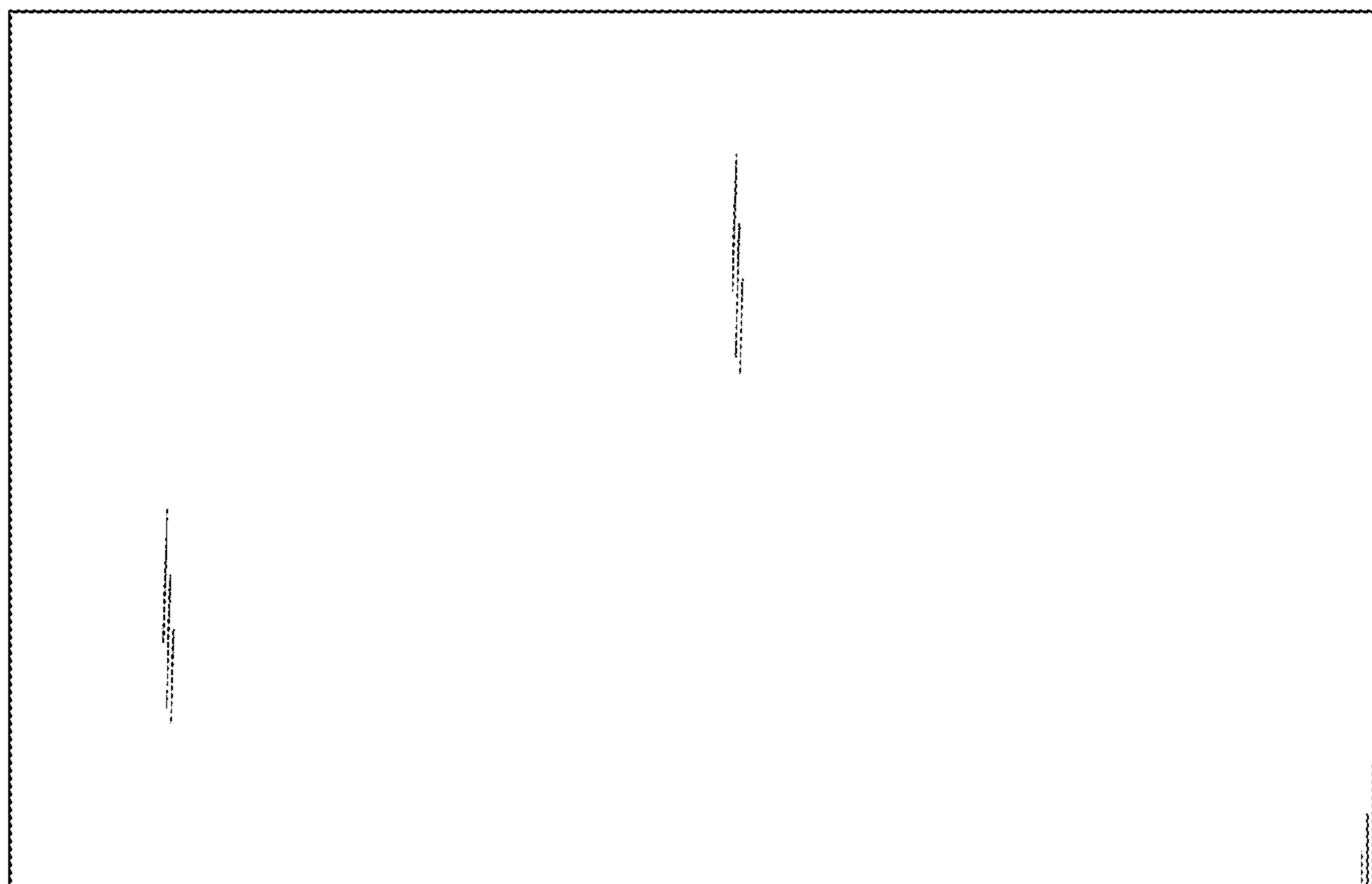

FIG. 23

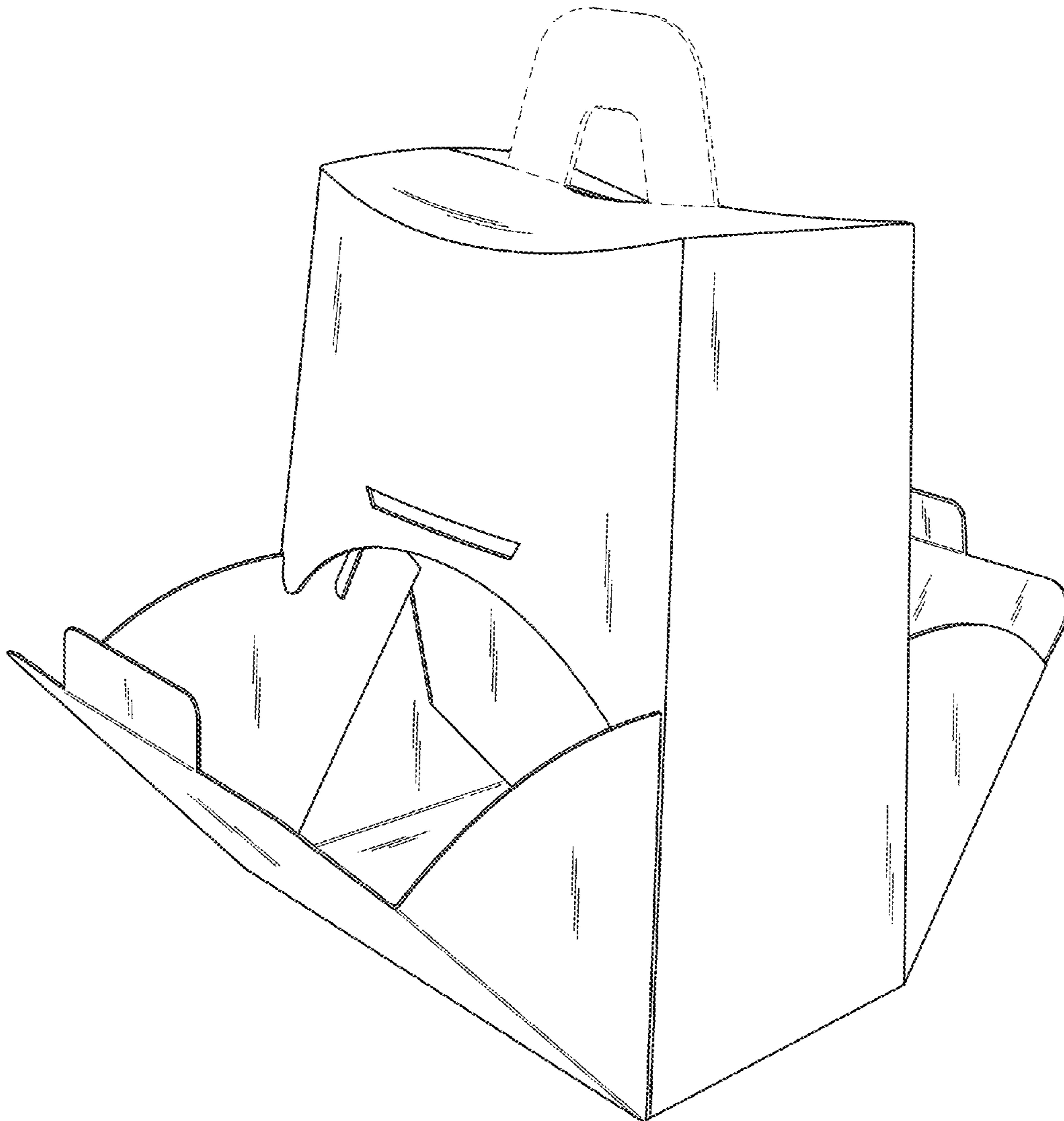

FIG. 24

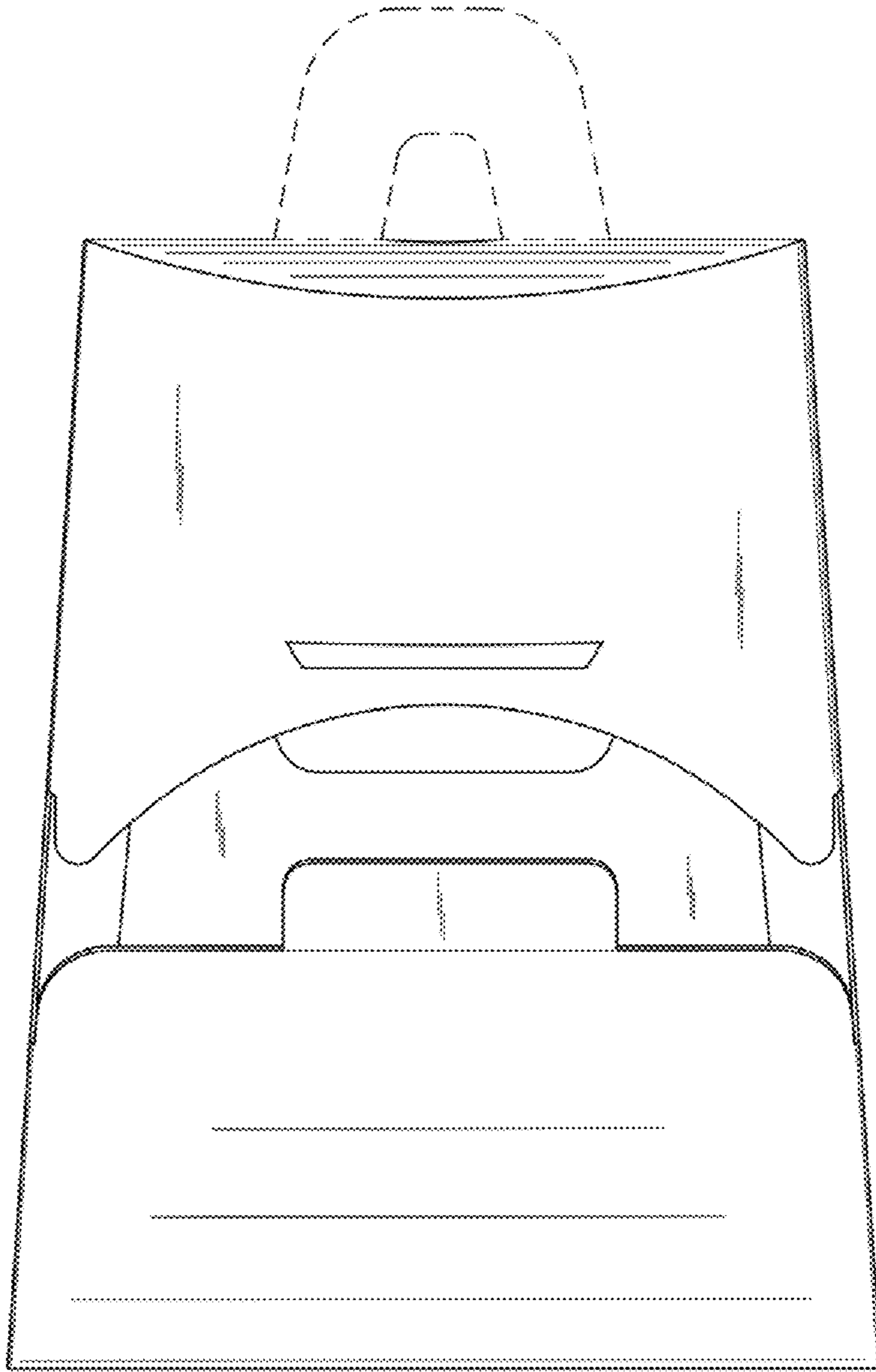

FIG. 25

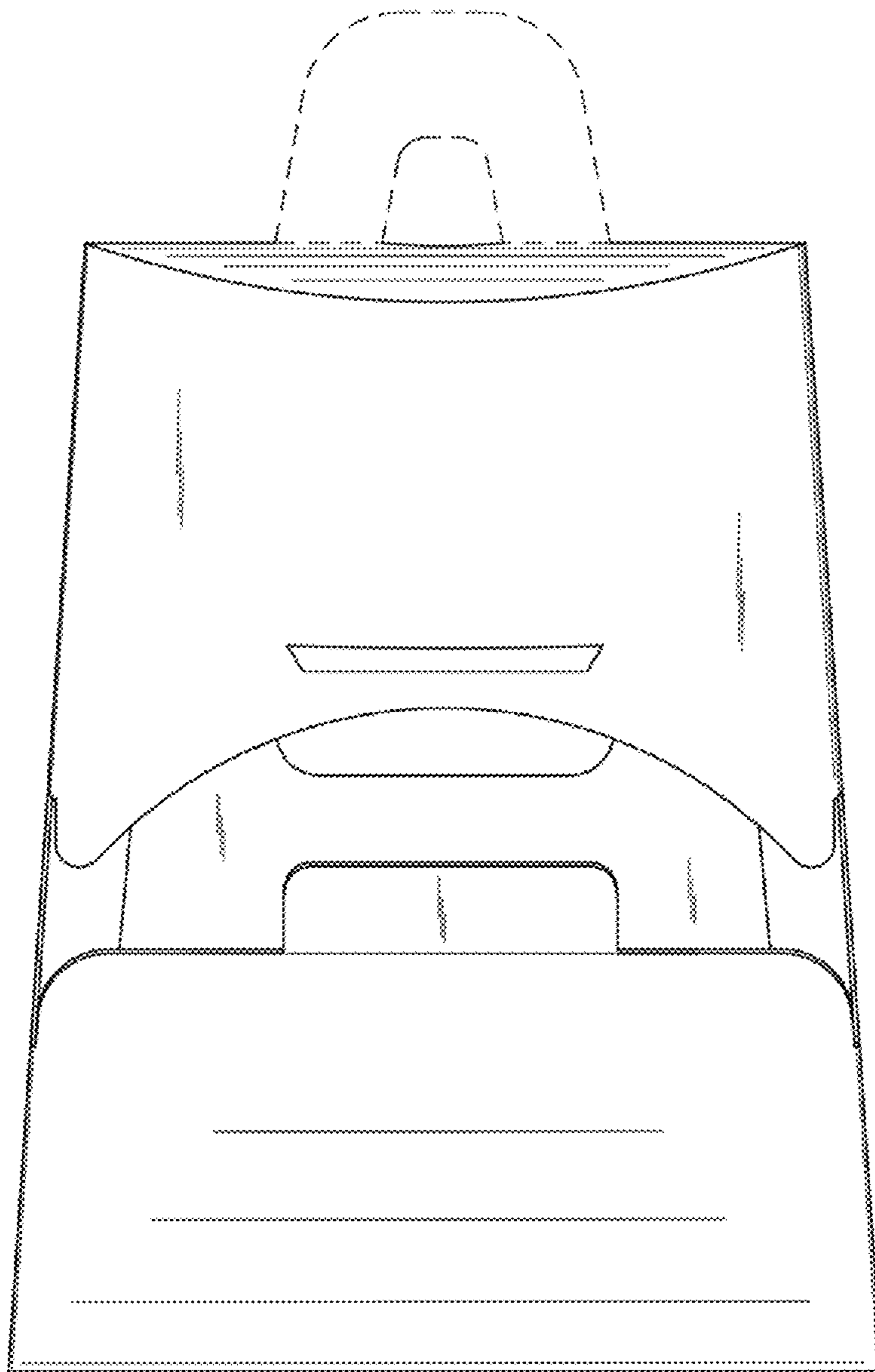

FIG. 26

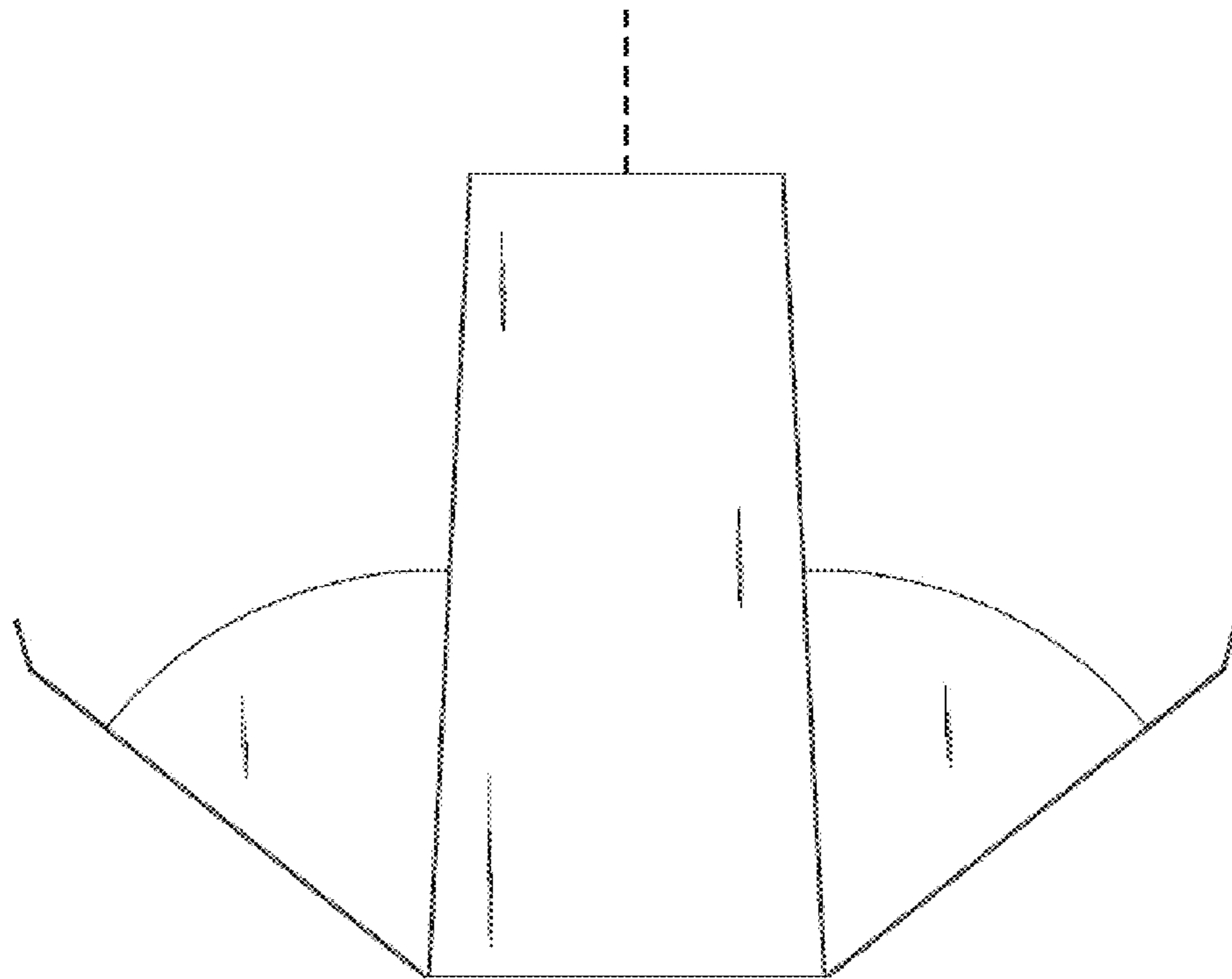

FIG. 27

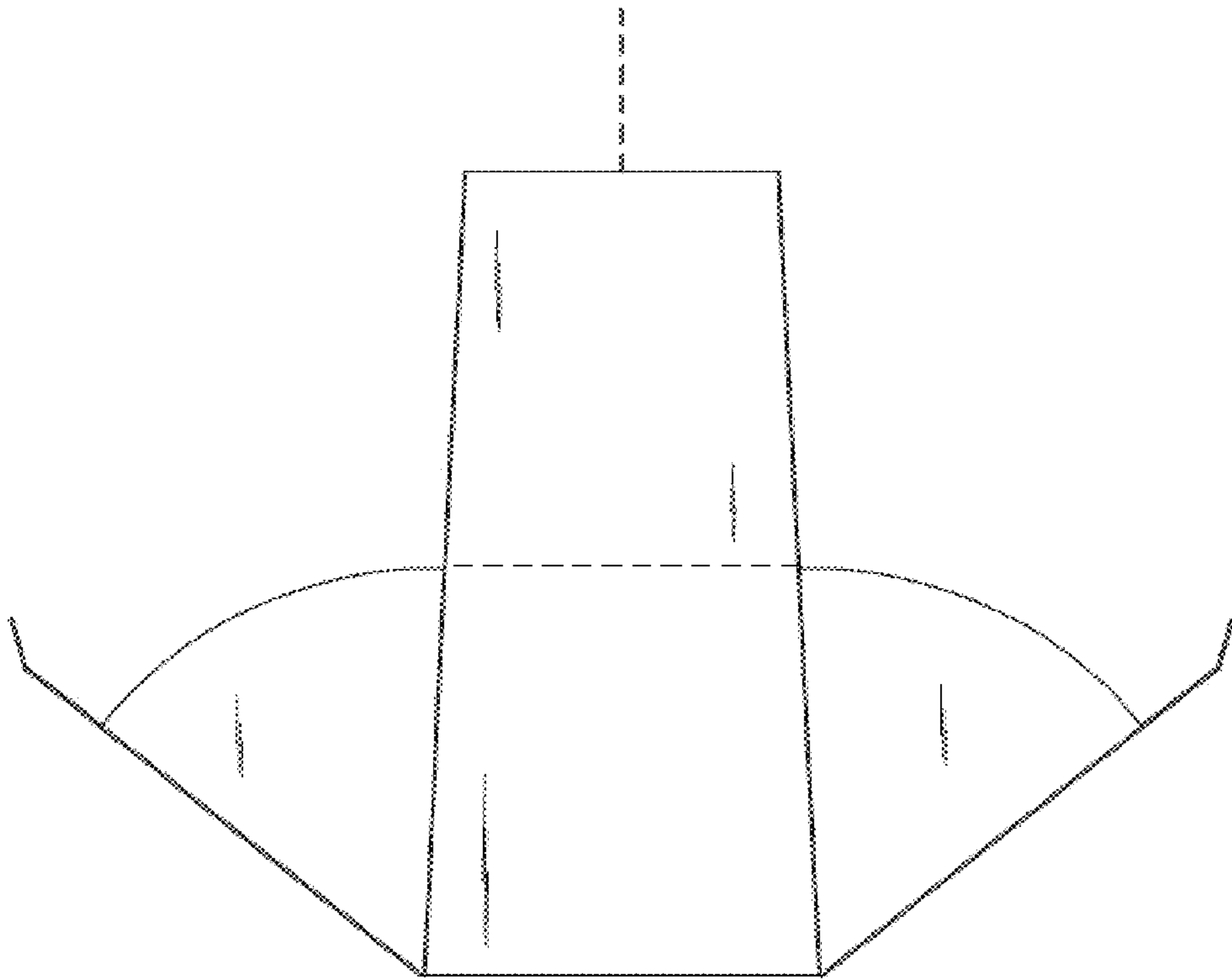

FIG. 28



FIG. 29

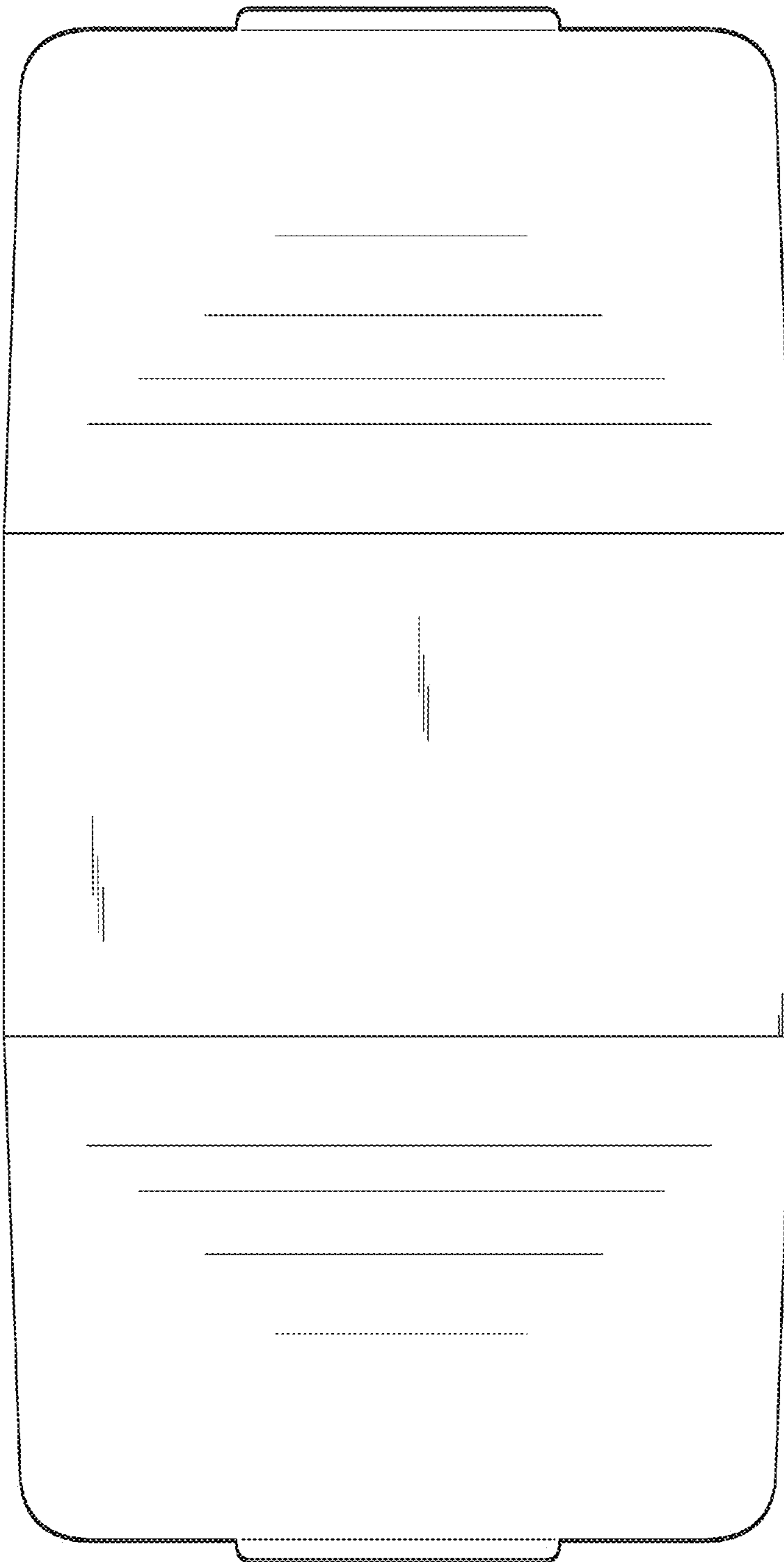

FIG. 30

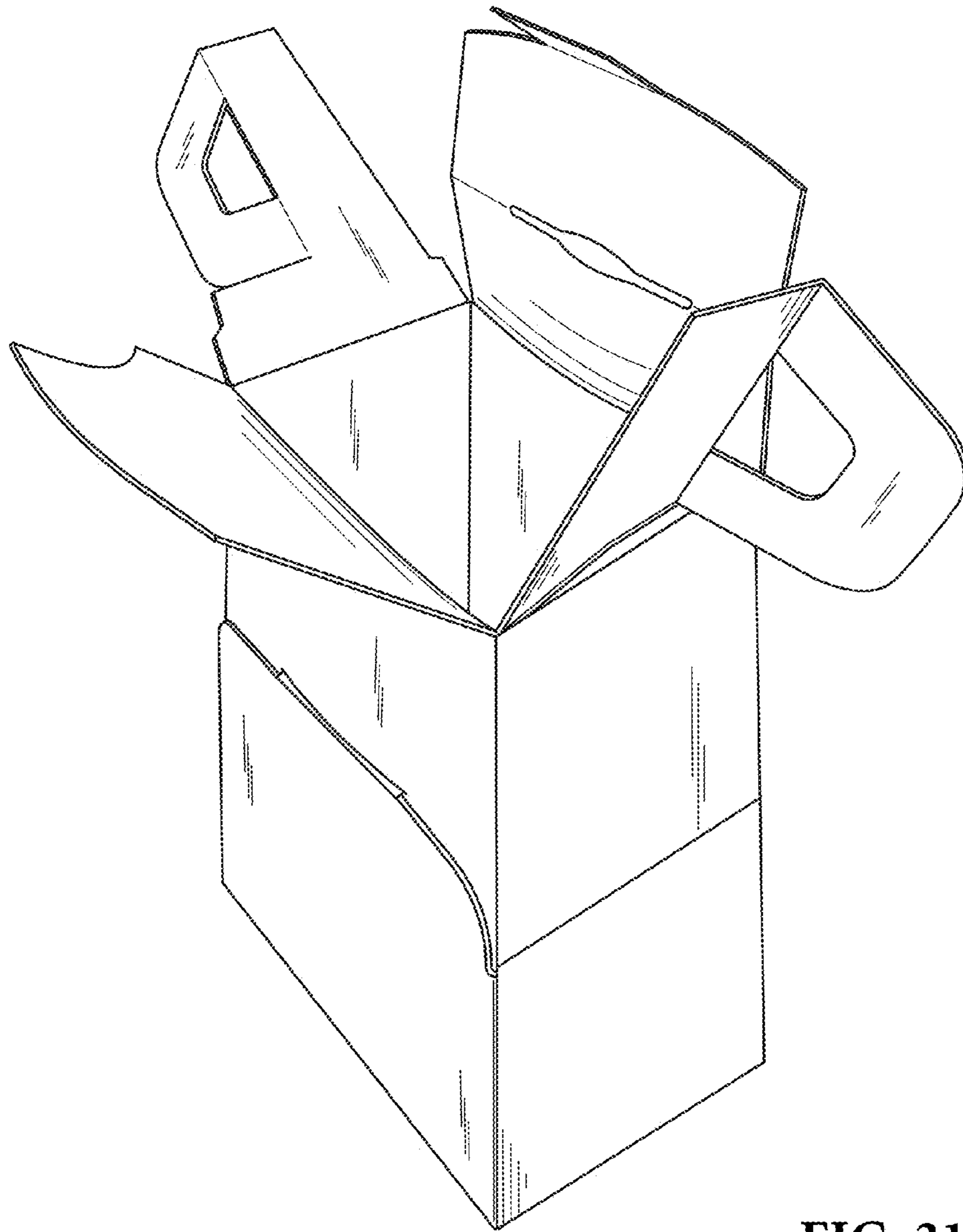

FIG. 31

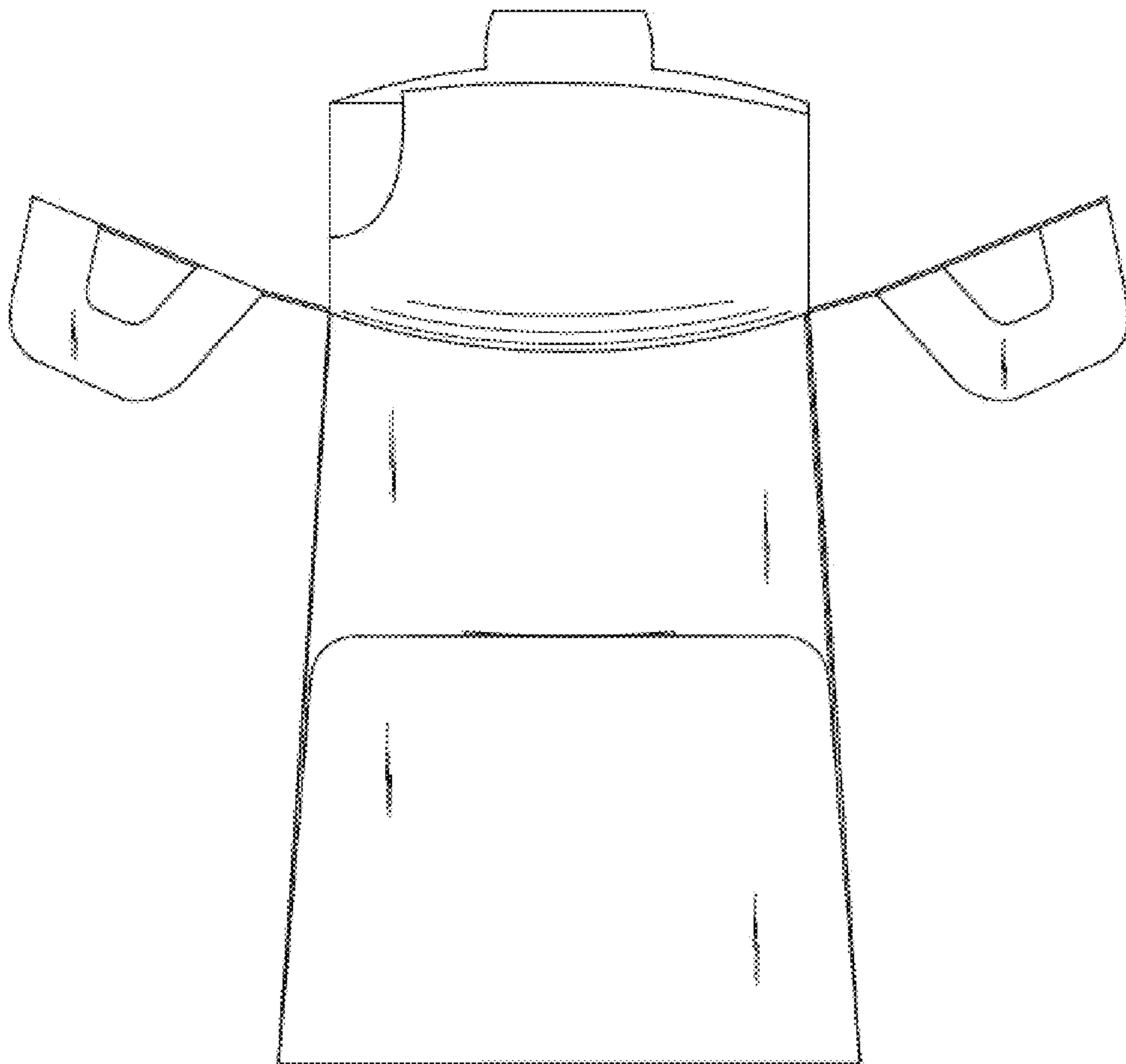

FIG. 32

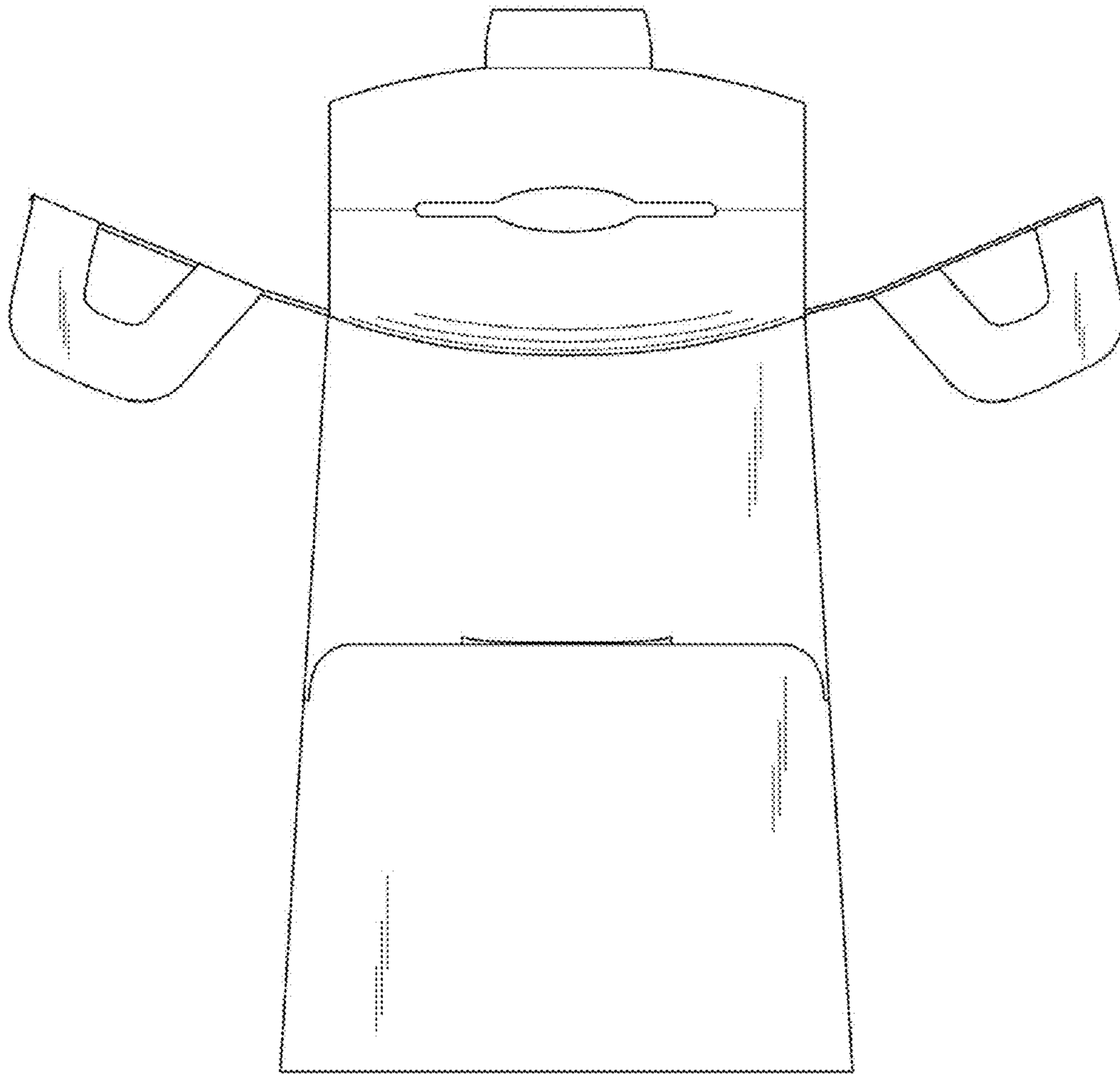

FIG. 33

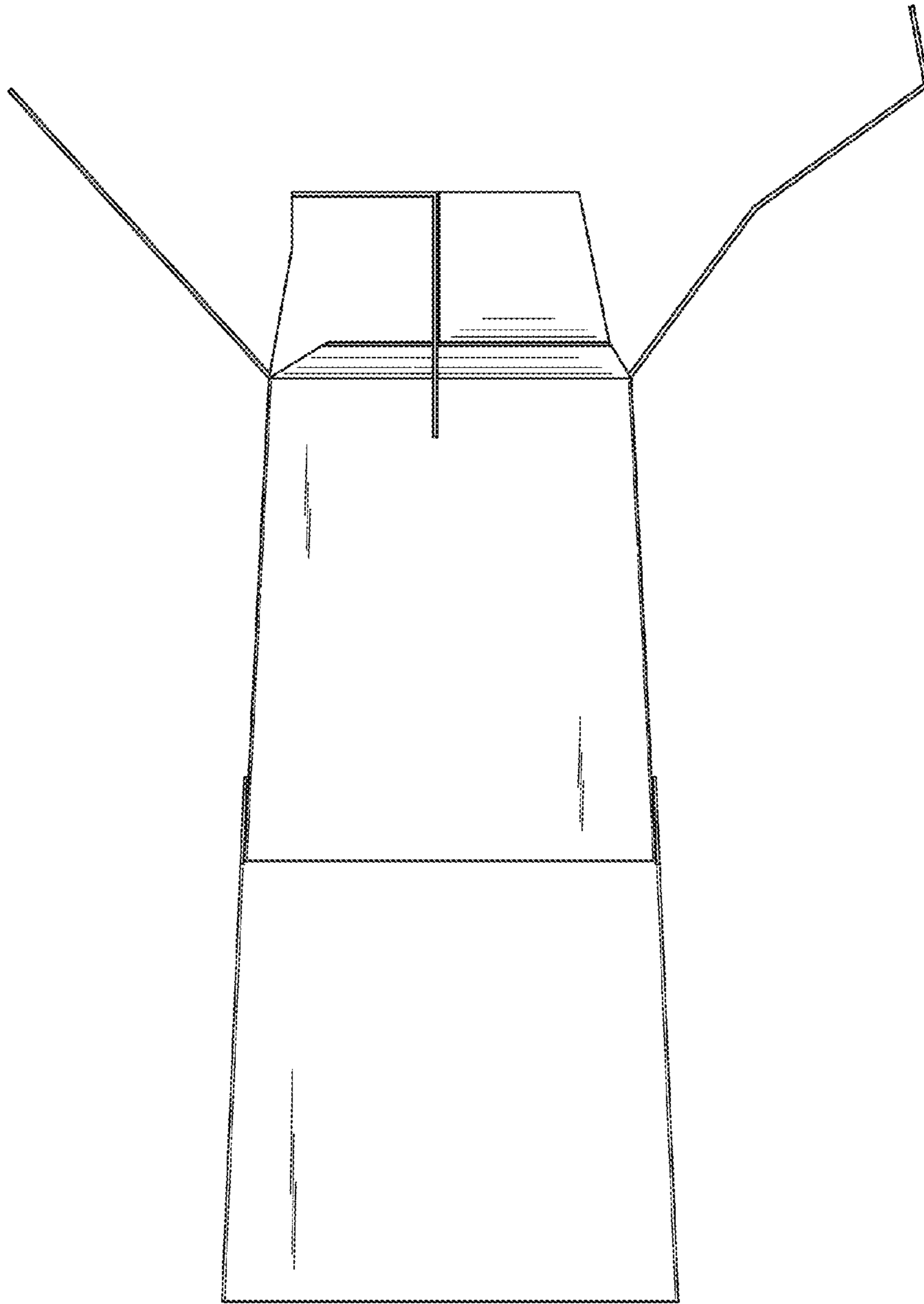

FIG. 34

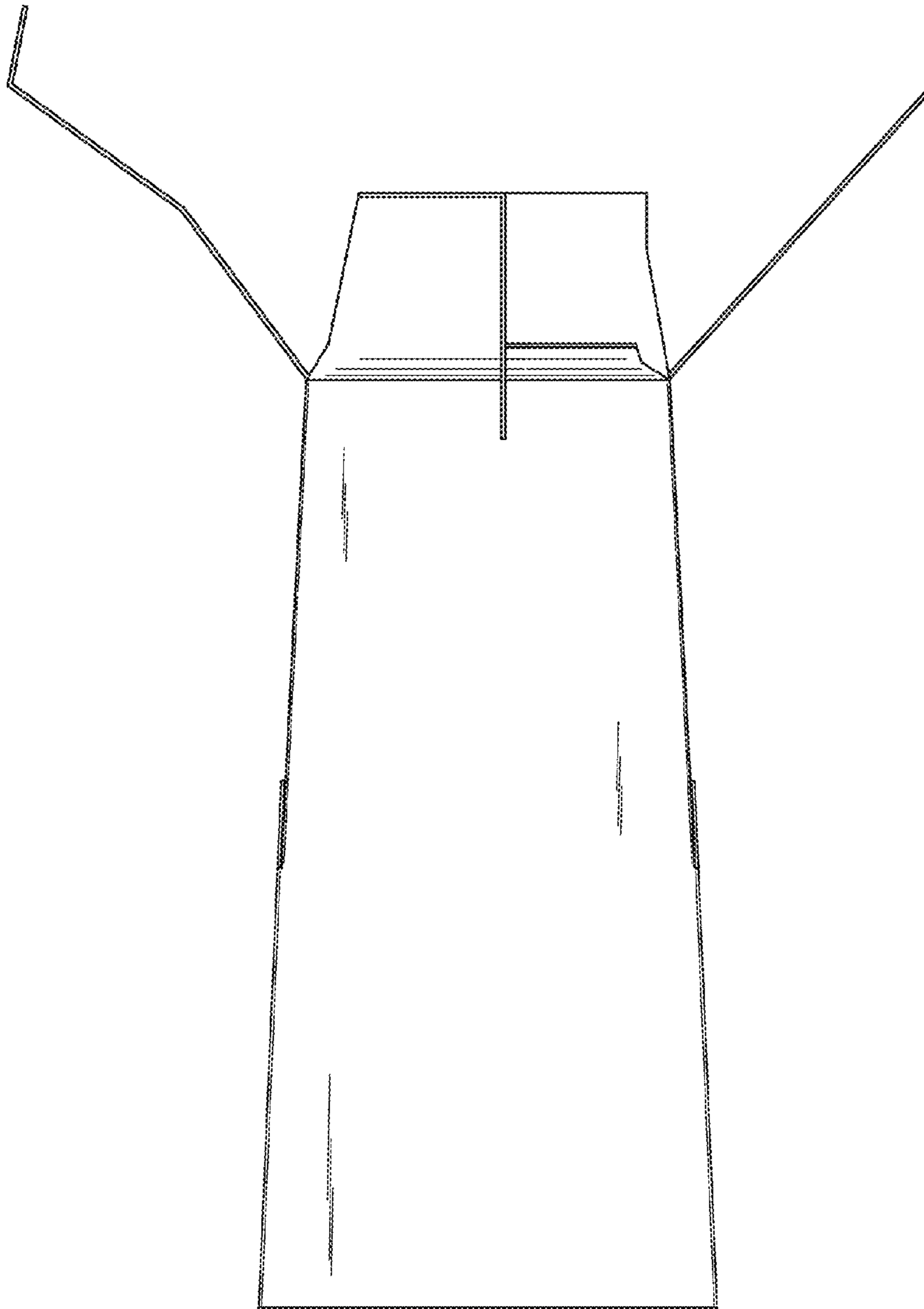

FIG. 35

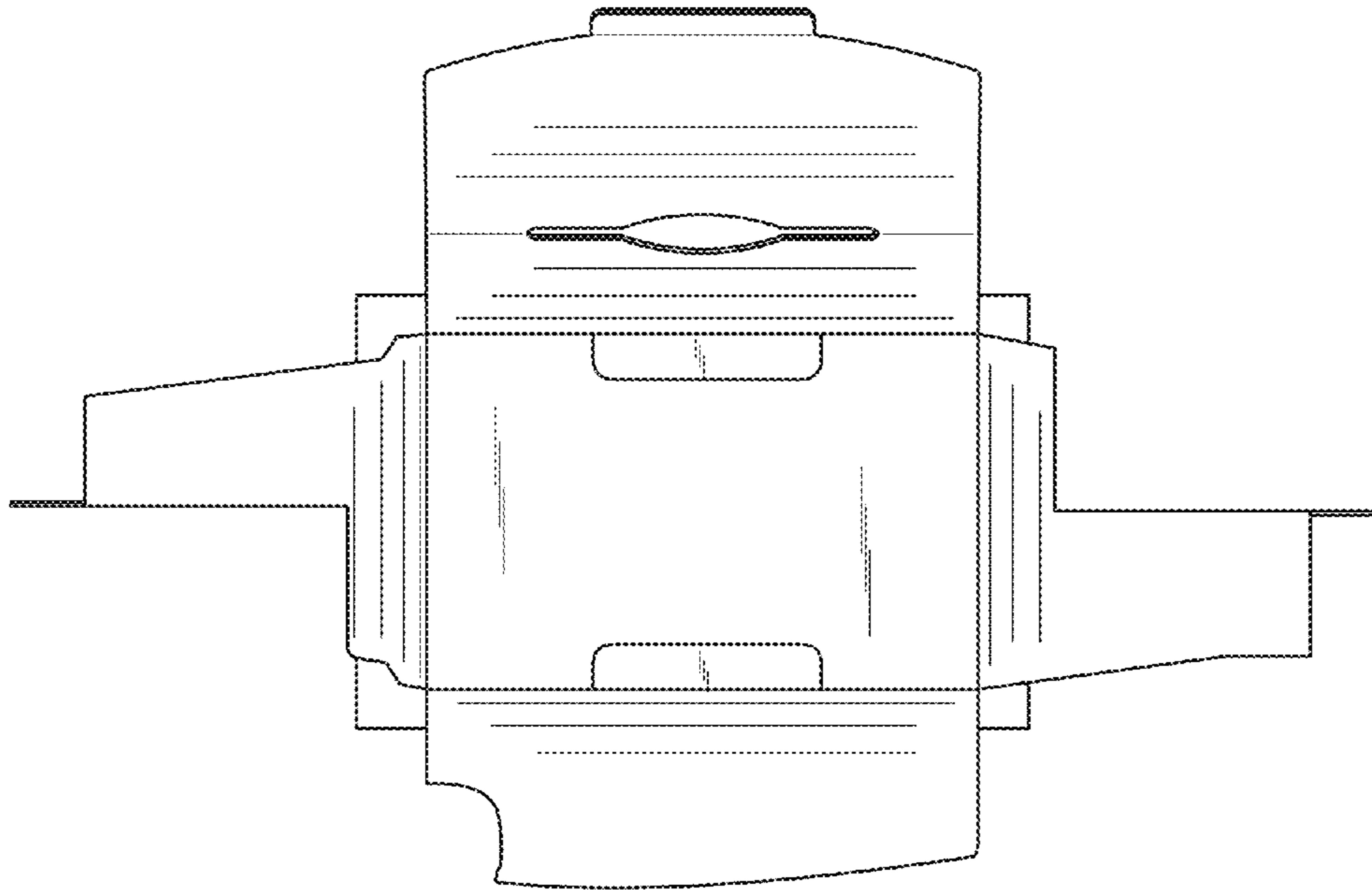

FIG. 36

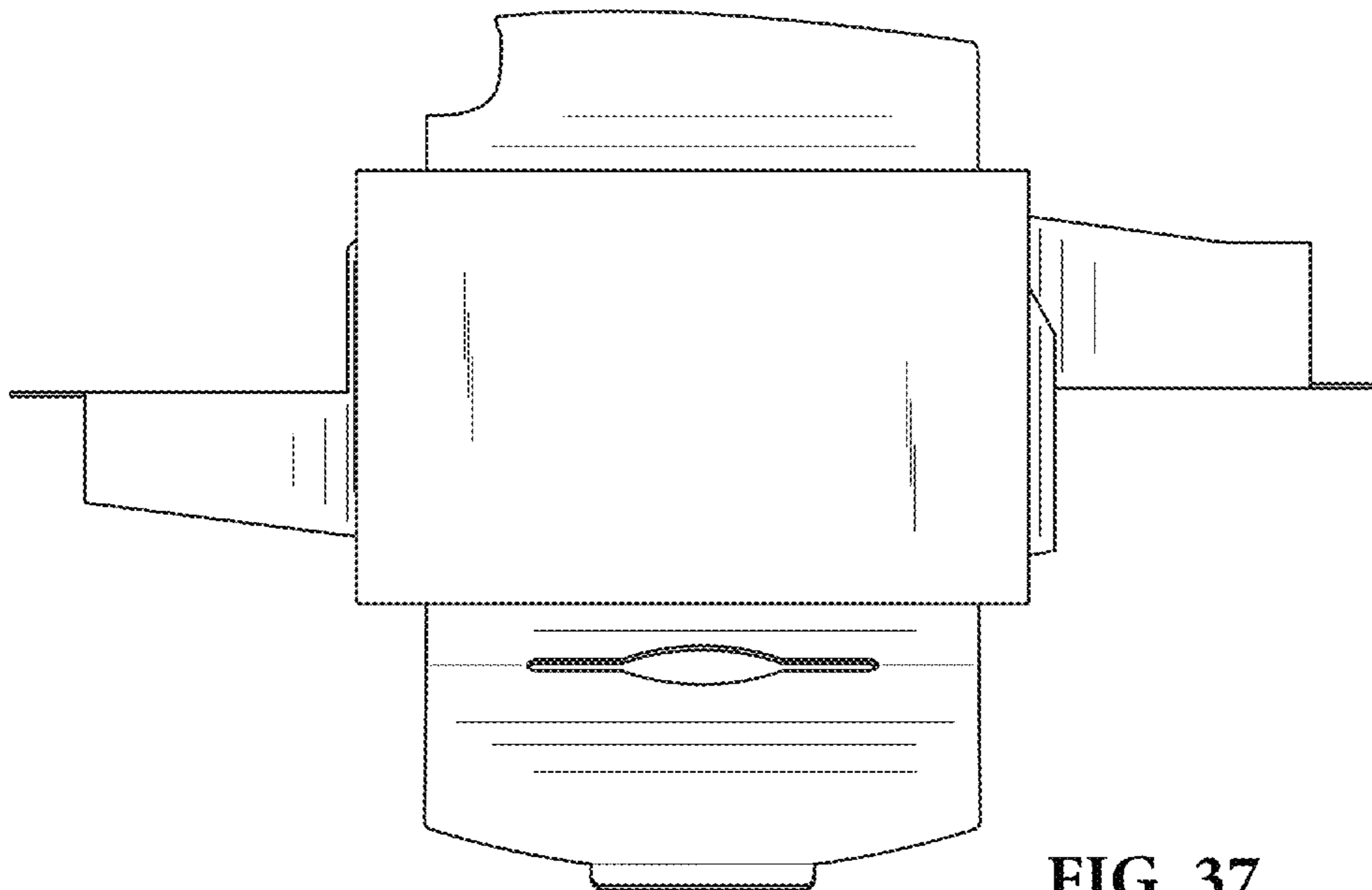

FIG. 37

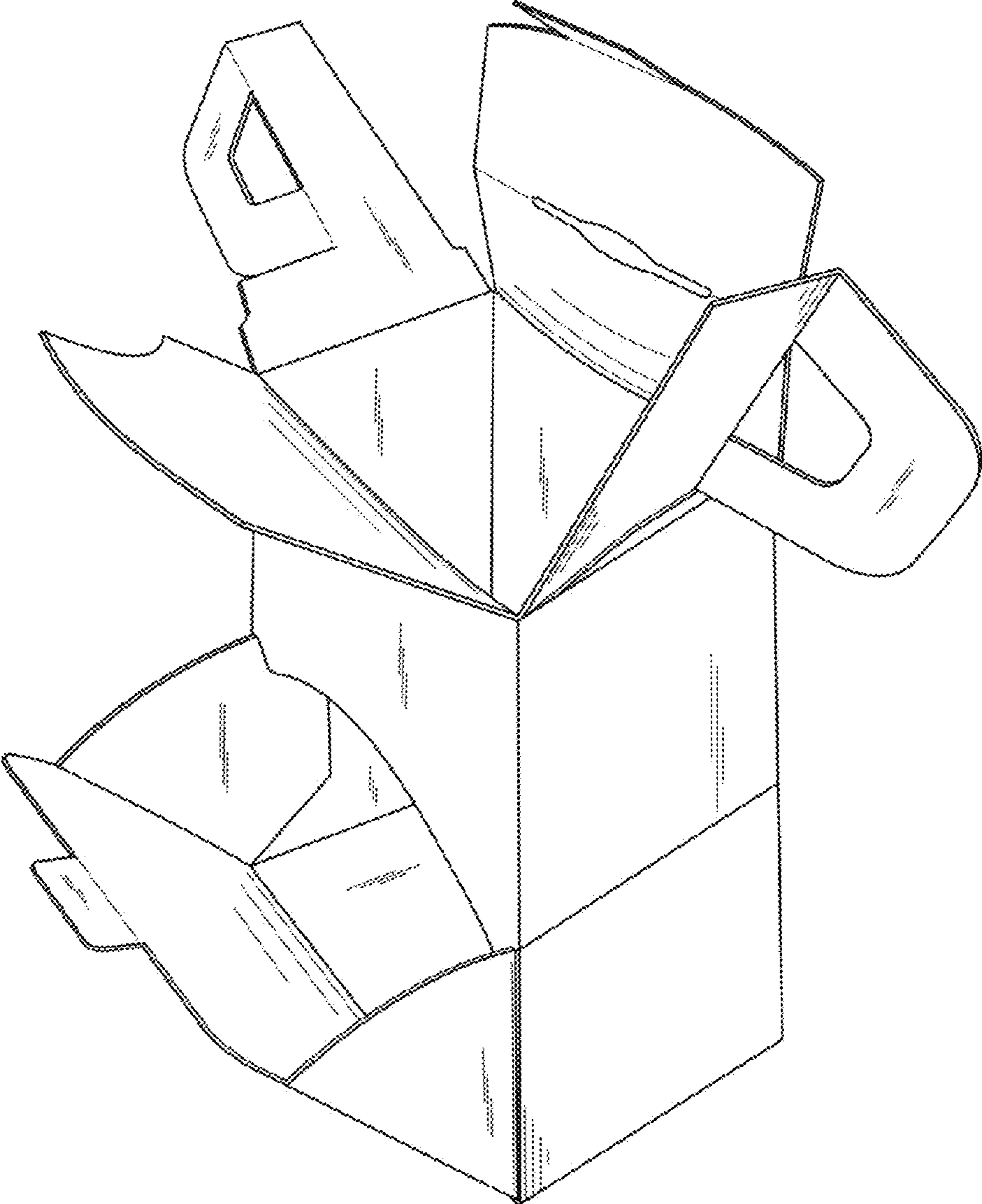

FIG. 38

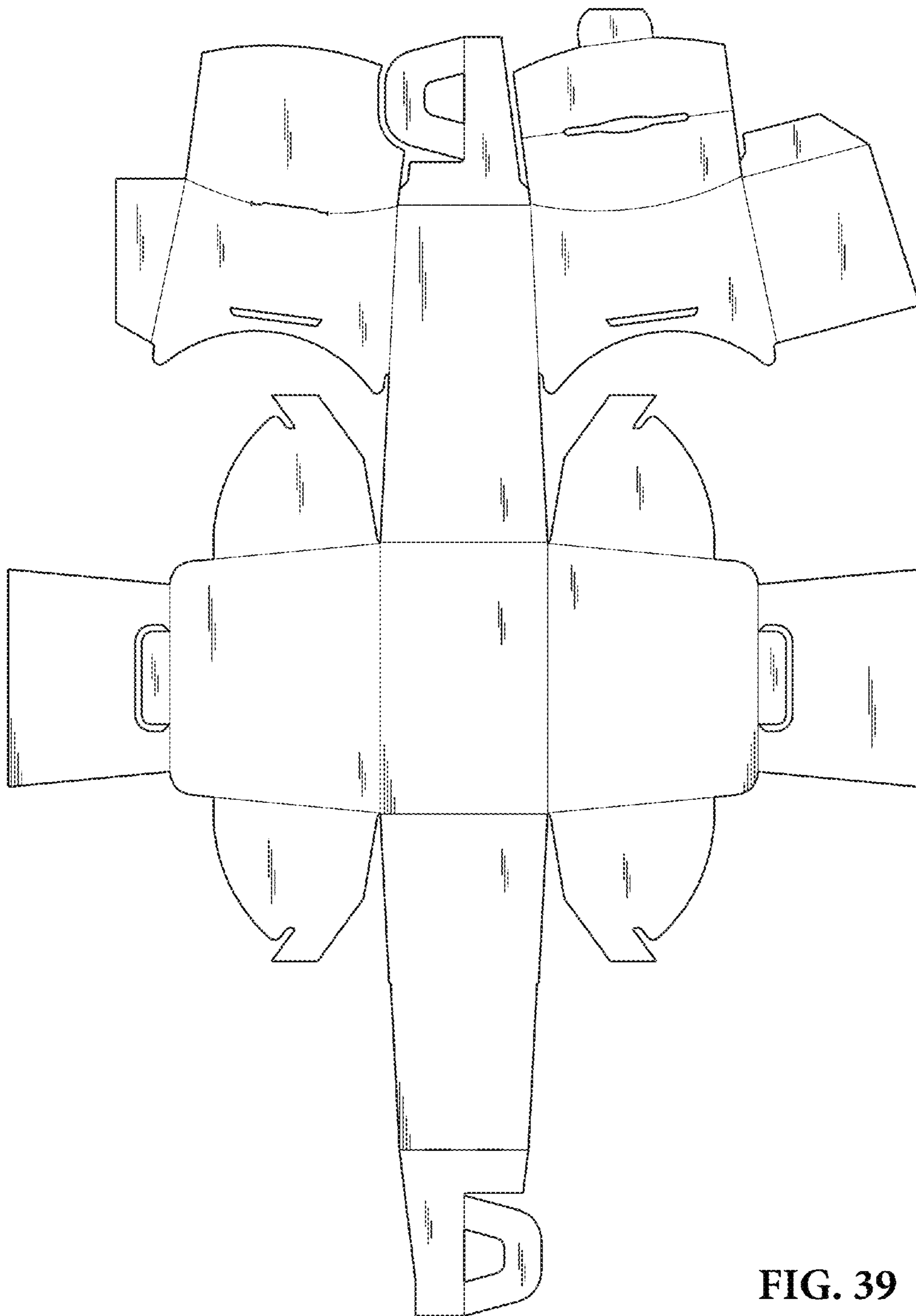

FIG. 39