



US00D765482S

(12) **United States Design Patent**
Kita

(10) **Patent No.:** **US D765,482 S**
(45) **Date of Patent:** **** Sep. 6, 2016**

- (54) **GRIP FOR DESOLDERING TOOL**
- (71) Applicant: **Hakko Corporation**, Osaka-shi, Osaka (JP)
- (72) Inventor: **Toshiyuki Kita**, Osaka (JP)
- (73) Assignee: **Hakko Corporation**, Osaka-shi, Osaka (JP)
- (**) Term: **15 Years**
- (21) Appl. No.: **29/529,640**
- (22) Filed: **Jun. 9, 2015**
- (30) **Foreign Application Priority Data**

Dec. 17, 2014 (JP) D2014-028109

- (51) **LOC (10) Cl.** **08-05**
- (52) **U.S. Cl.**
USPC **D8/30**

- (58) **Field of Classification Search**
USPC D8/14, 29.1, 29.2, 30, 68
CPC B23K 1/018; B23K 1/00; B23K 1/08;
B23K 3/00; B23K 3/02
See application file for complete search history.

(56) **References Cited**

U.S. PATENT DOCUMENTS

- 2,882,380 A * 4/1959 Campo B23K 1/018
219/230
- 4,574,994 A * 3/1986 Rauchwerger B23K 1/018
228/20.5
- 5,007,574 A * 4/1991 Carlomagno B23K 1/018
219/236
- 5,143,272 A * 9/1992 Carlomagno B23K 3/029
228/20.5

- 6,057,527 A * 5/2000 Kilmer B23K 1/018
219/227
- D456,684 S * 5/2002 Izumisawa D8/62
- D514,408 S * 2/2006 Melendy D8/14.1
- D514,413 S * 2/2006 Cuenca D8/68
- D740,091 S * 10/2015 Mochizuki D8/30

OTHER PUBLICATIONS

Hakko Corporation, product information for desoldering tool, available from < http://www.hakko.com/japan/products/hakko_474.html >, published May 2013.

* cited by examiner

Primary Examiner — Phillip S Hyder

(74) *Attorney, Agent, or Firm* — Squire Patton Boggs (US) LLP

(57) **CLAIM**

The ornamental design for a grip for desoldering tool, as shown and described.

DESCRIPTION

FIG. 1 is a first perspective view of a grip for desoldering tool;
FIG. 2 is a second perspective view thereof;
FIG. 3 is a front view thereof;
FIG. 4 is a rear view thereof;
FIG. 5 is a left side view thereof;
FIG. 6 is a right side view thereof;
FIG. 7 is a top view thereof; and,
FIG. 8 is a bottom view thereof.

The broken lines depict portions of the grip for desoldering tool in which the design is embodied that are not considered part of the claimed design.

1 Claim, 8 Drawing Sheets

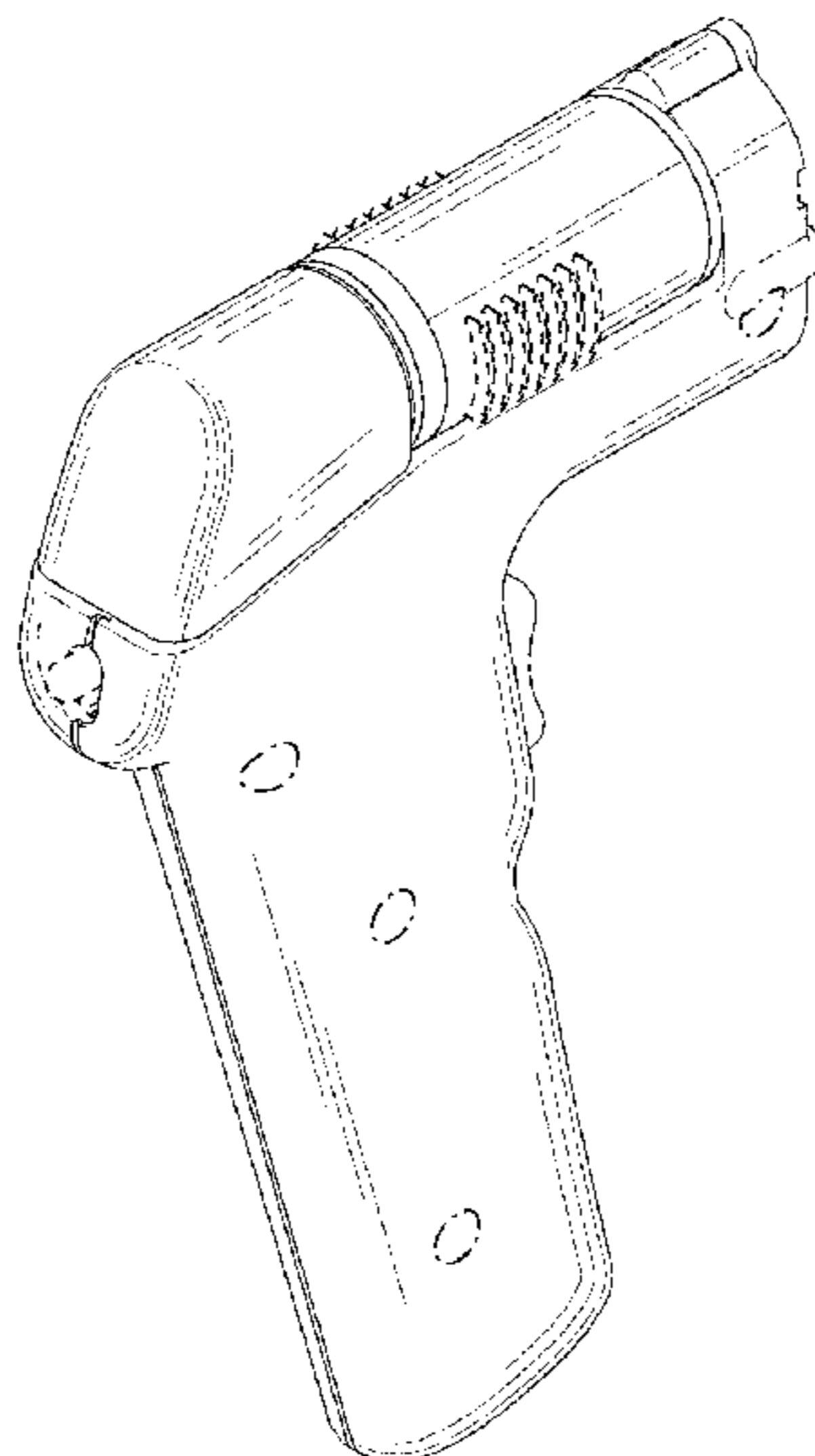

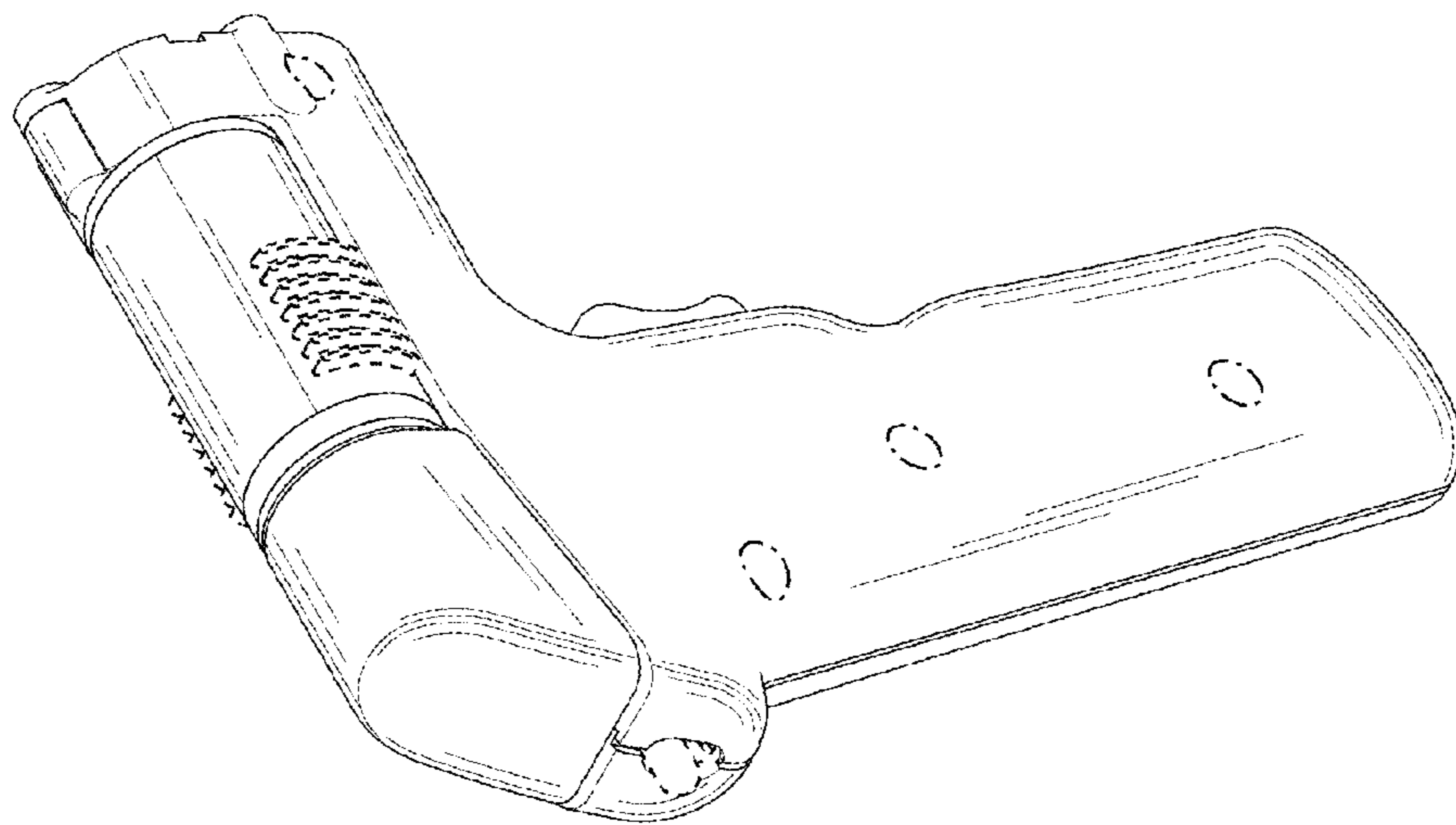

FIG.1

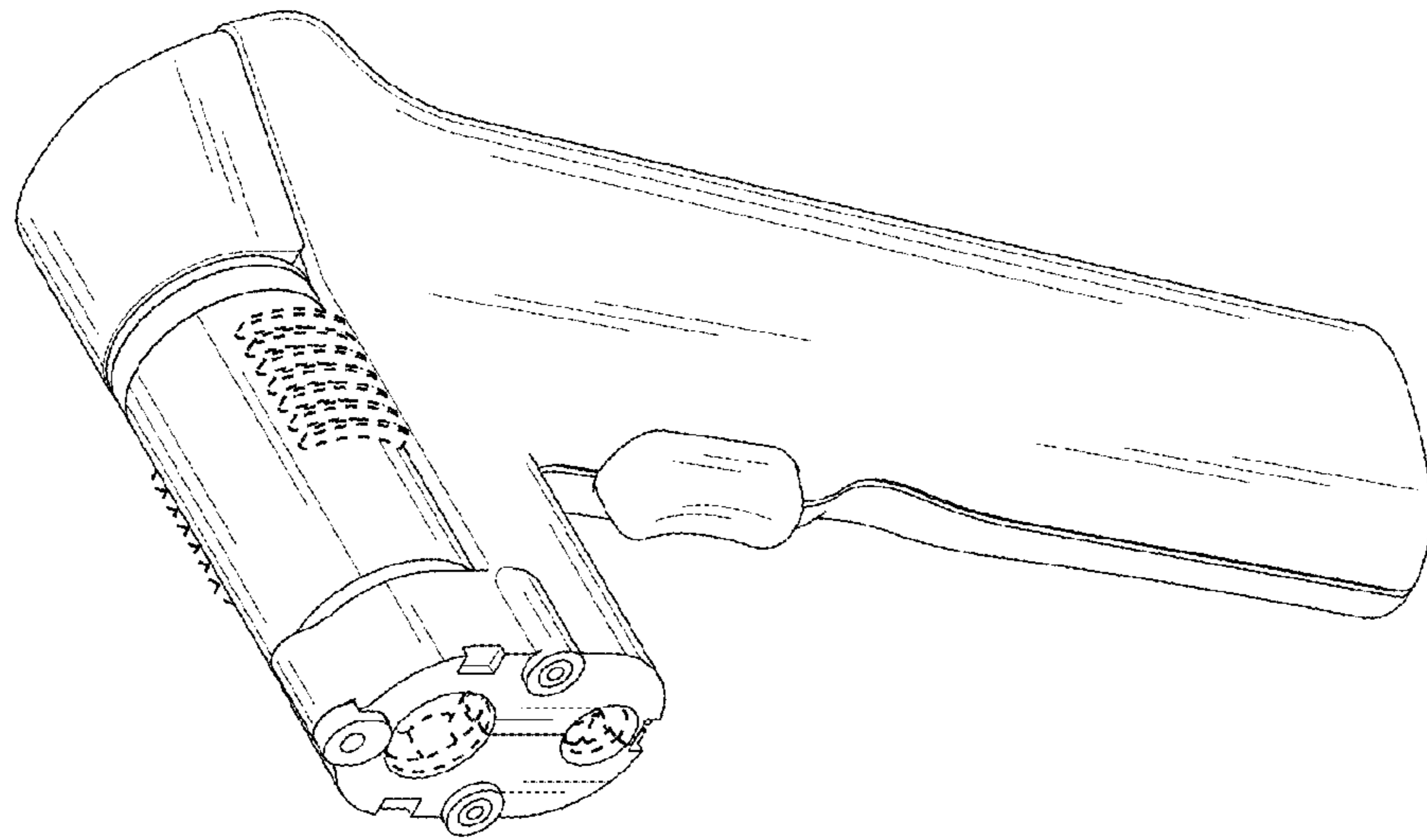

FIG. 2

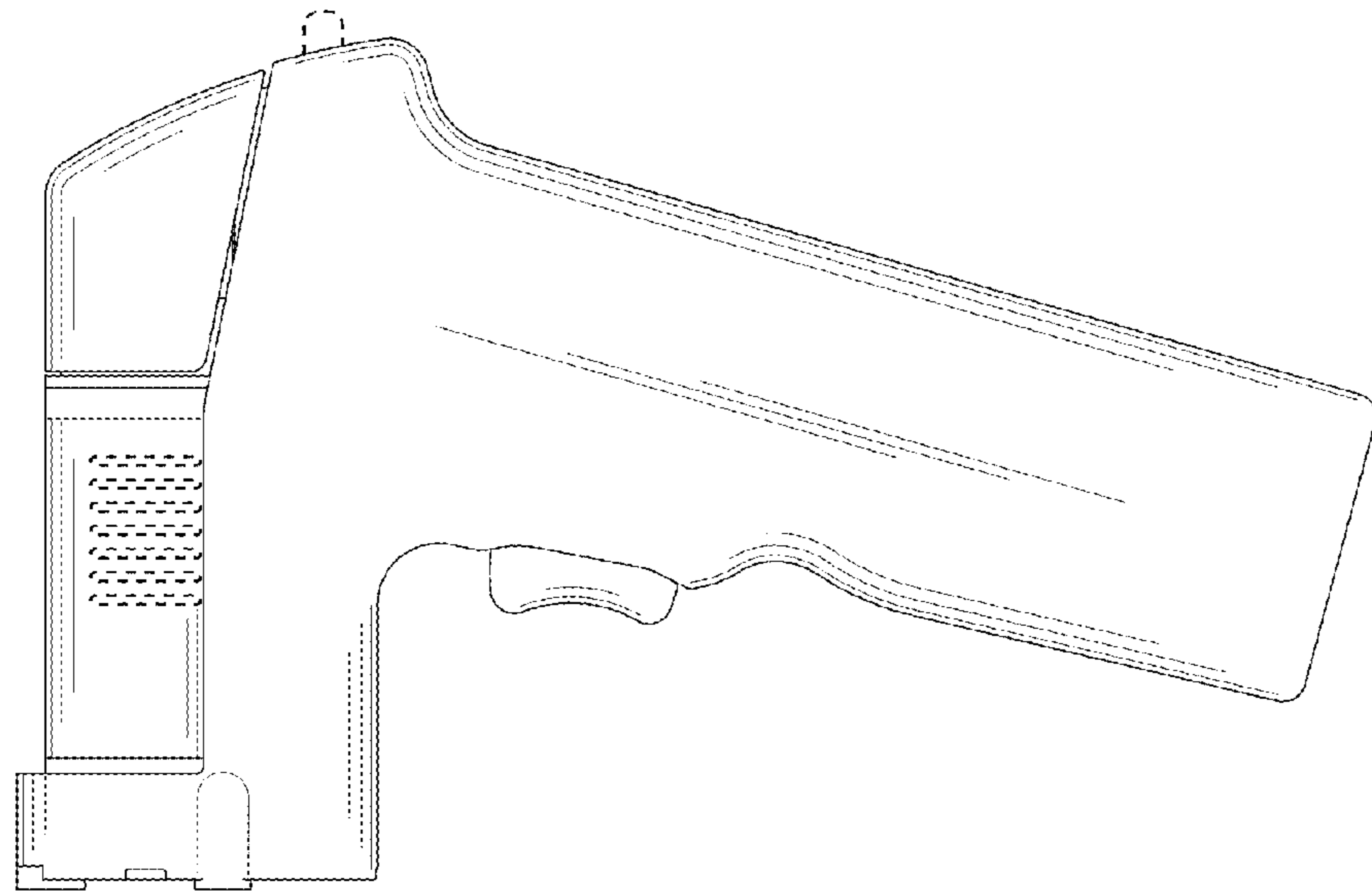

FIG.3

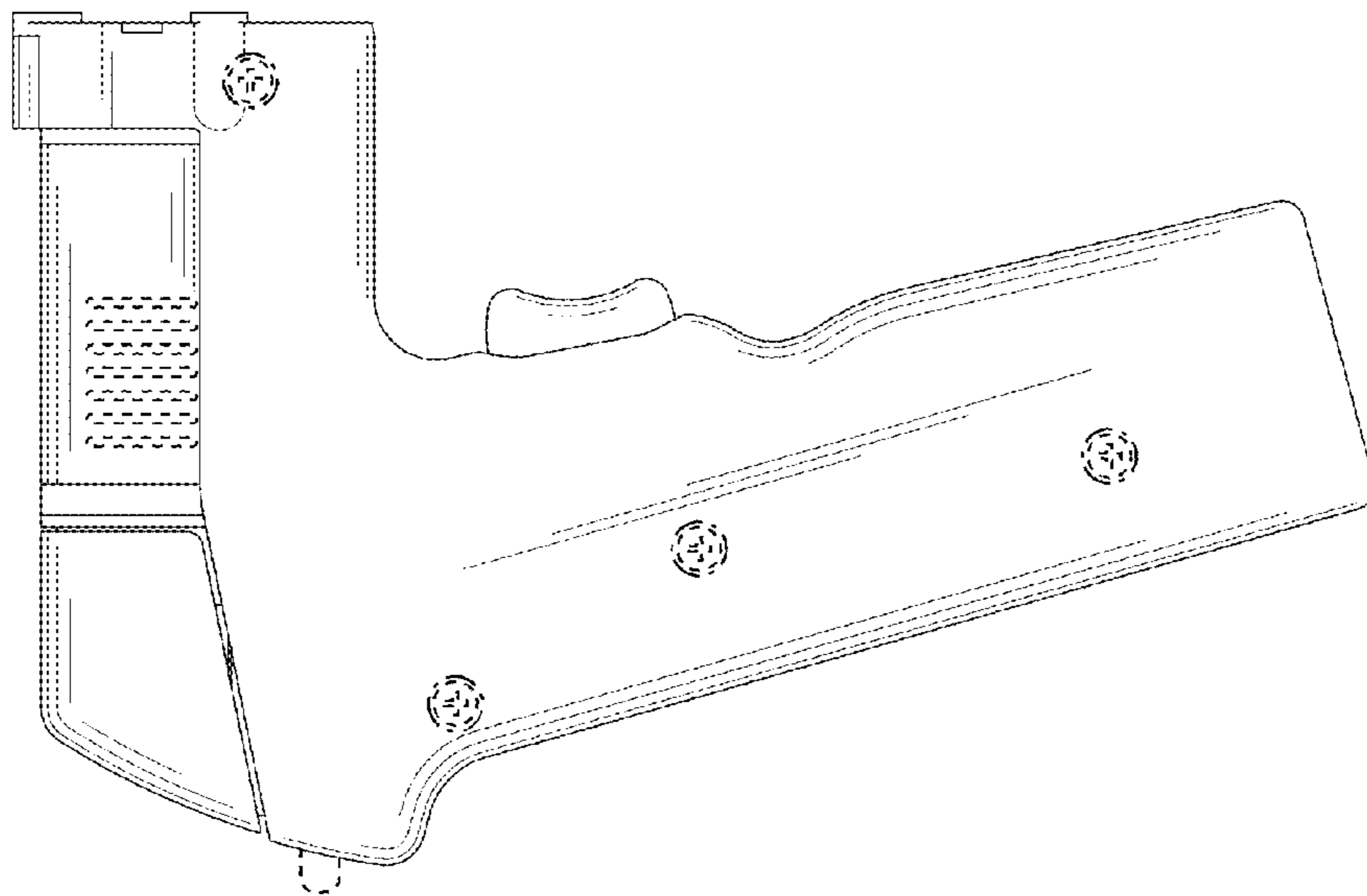

FIG.4

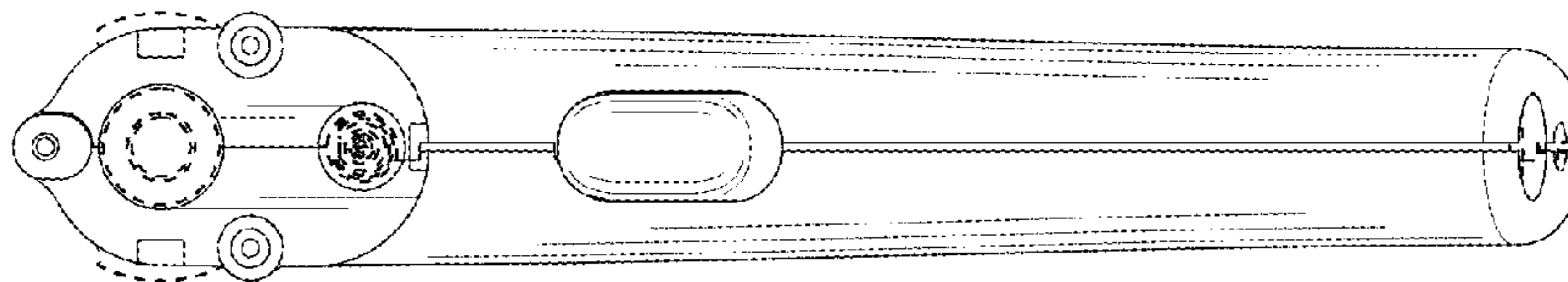

FIG. 5

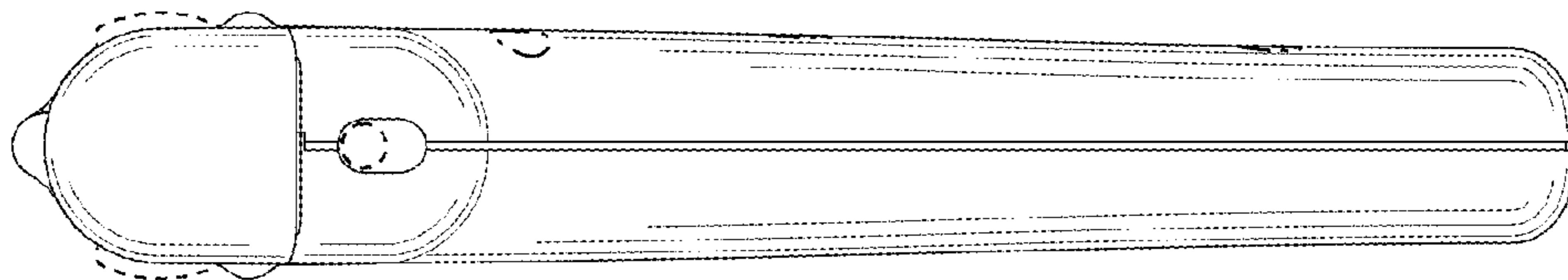

FIG.6

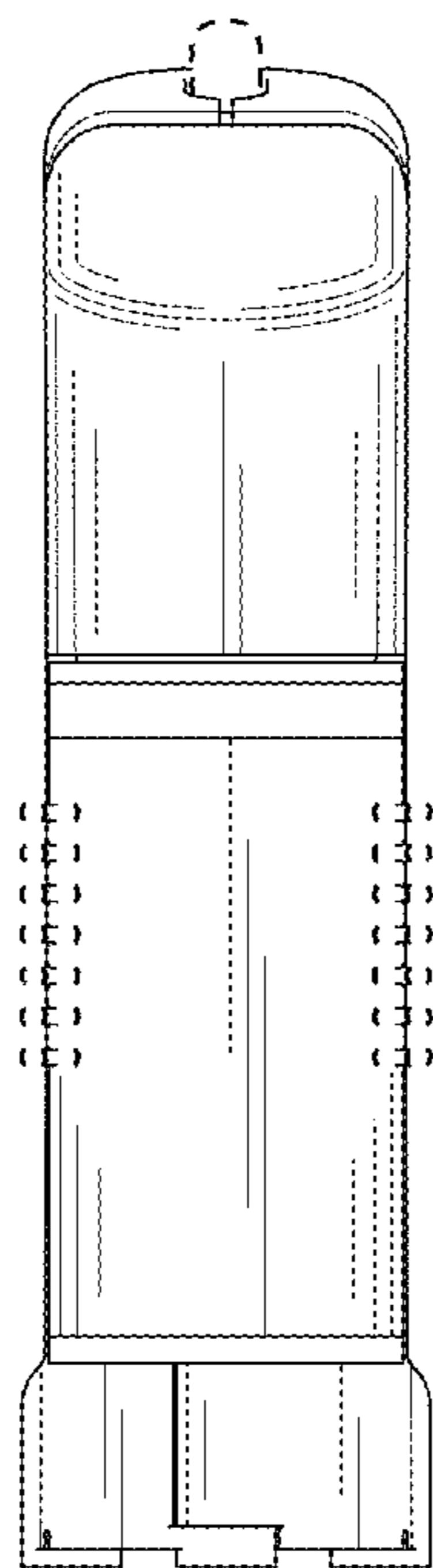

FIG. 7

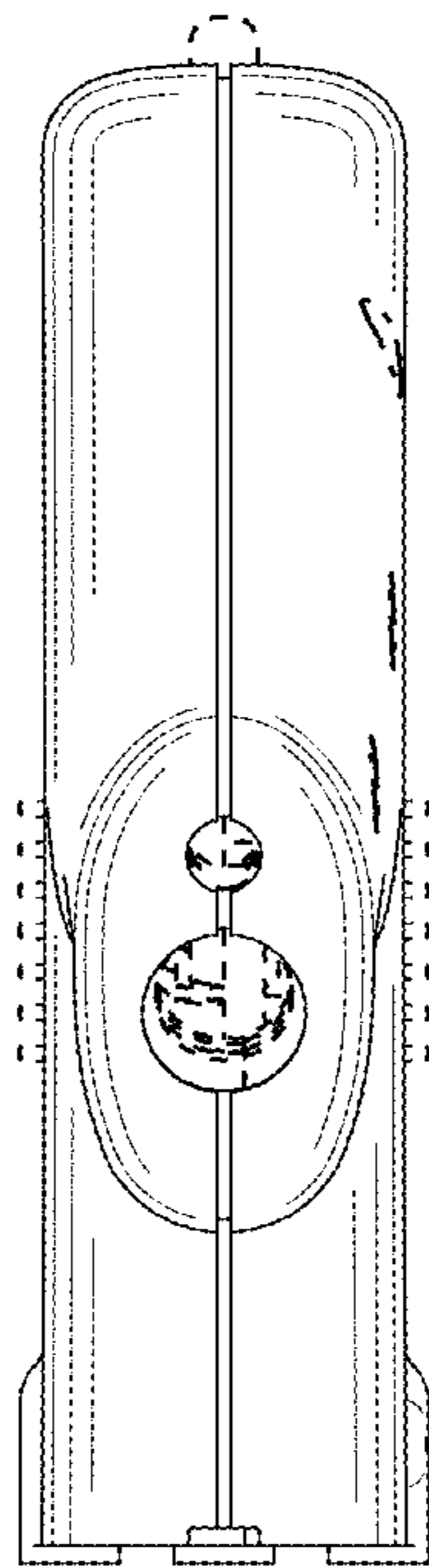

FIG.8