



US00D765201S

(12) **United States Design Patent**  
**Gibson**

(10) **Patent No.:** **US D765,201 S**

(45) **Date of Patent:** **\*\* Aug. 30, 2016**

(54) **PERSONAL FLOTATION AND CUSHION  
DEVICE**

5,791,958 A \* 8/1998 Yeung ..... B63B 35/74  
441/130  
7,335,079 B1 \* 2/2008 Darling ..... B63C 9/082  
441/129

(71) Applicant: **Colin Gibson**, Mesa, AZ (US)

\* cited by examiner

(72) Inventor: **Colin Gibson**, Mesa, AZ (US)

*Primary Examiner* — Zenia Bennett

(\*\*) Term: **14 Years**

(74) *Attorney, Agent, or Firm* — Booth Udall Fuller, PLC

(21) Appl. No.: **29/525,308**

(57) **CLAIM**

(22) Filed: **Apr. 28, 2015**

The ornamental design for the personal flotation and cushion device, as shown and described.

(51) **LOC (10) Cl.** ..... **21-06**

**DESCRIPTION**

(52) **U.S. Cl.**

USPC ..... **D21/803**

(58) **Field of Classification Search**

USPC ..... D21/769–770, 801, 803, 809; 114/253,  
114/345–346; 441/35, 66, 74, 40–42,  
441/129–132; 472/128–129; D12/5, 6, 316;  
D6/392, 595, 596, 601, 604, 605

CPC ..... B63B 35/76

See application file for complete search history.

FIG. 1 is a perspective view of the personal flotation and cushion device in an unfolded configuration;

FIG. 2 is a top view thereof;

FIG. 3 is a bottom view thereof;

FIG. 4 is a left side view thereof;

FIG. 5 is a right side view thereof;

FIG. 6 is a front view thereof;

FIG. 7 is a back view thereof;

FIG. 8 is a perspective view of the personal flotation and cushion device in a folded, chair configuration;

FIG. 9 is a front view thereof;

FIG. 10 is a back view thereof;

FIG. 11 is a right side view thereof;

FIG. 12 is a left side view thereof;

FIG. 13 is a top view thereof; and,

FIG. 14 is a bottom view thereof.

The broken lines in the drawings illustrate features that form no part of the claimed design.

(56) **References Cited**

**U.S. PATENT DOCUMENTS**

5,273,473 A \* 12/1993 Allen ..... B63B 7/06  
114/219  
D349,146 S \* 7/1994 Mahler ..... D21/809  
D366,800 S \* 2/1996 Moore, Jr. .... D6/596  
D376,689 S \* 12/1996 Doppelt ..... D3/274  
D376,946 S \* 12/1996 Maxim ..... D6/596  
5,779,513 A \* 7/1998 Burton ..... B63B 35/74  
441/129

**1 Claim, 8 Drawing Sheets**

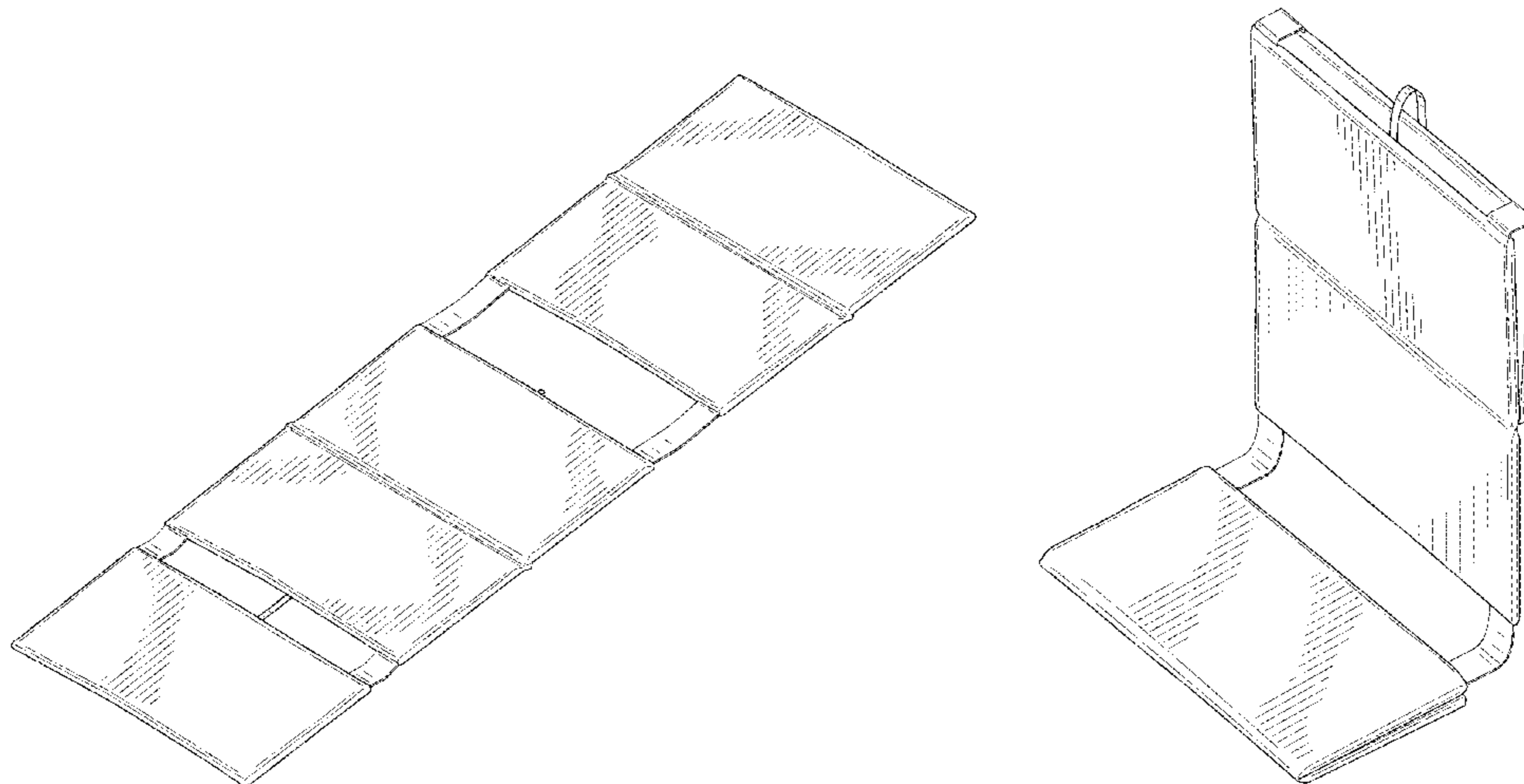

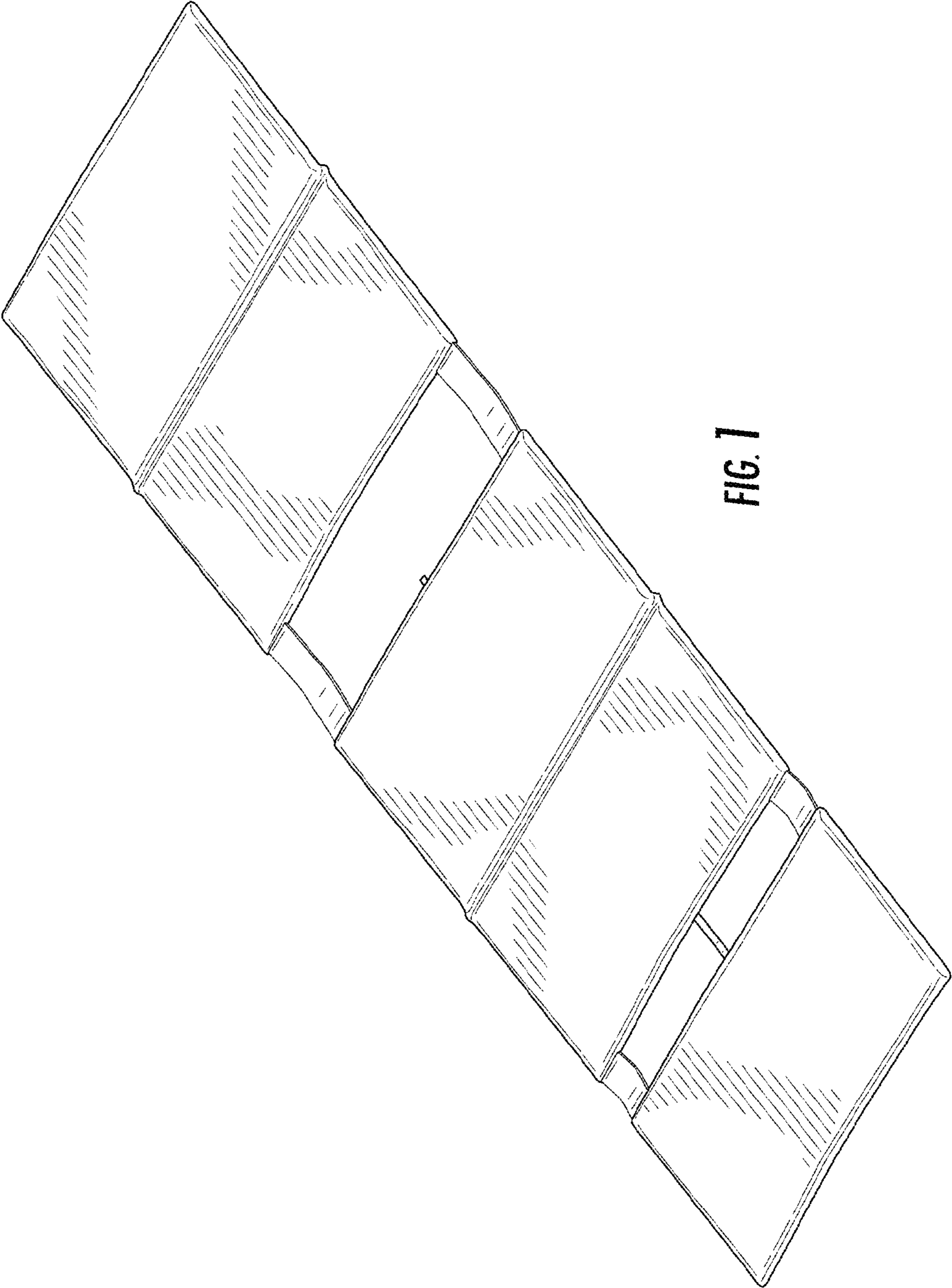

FIG. 1

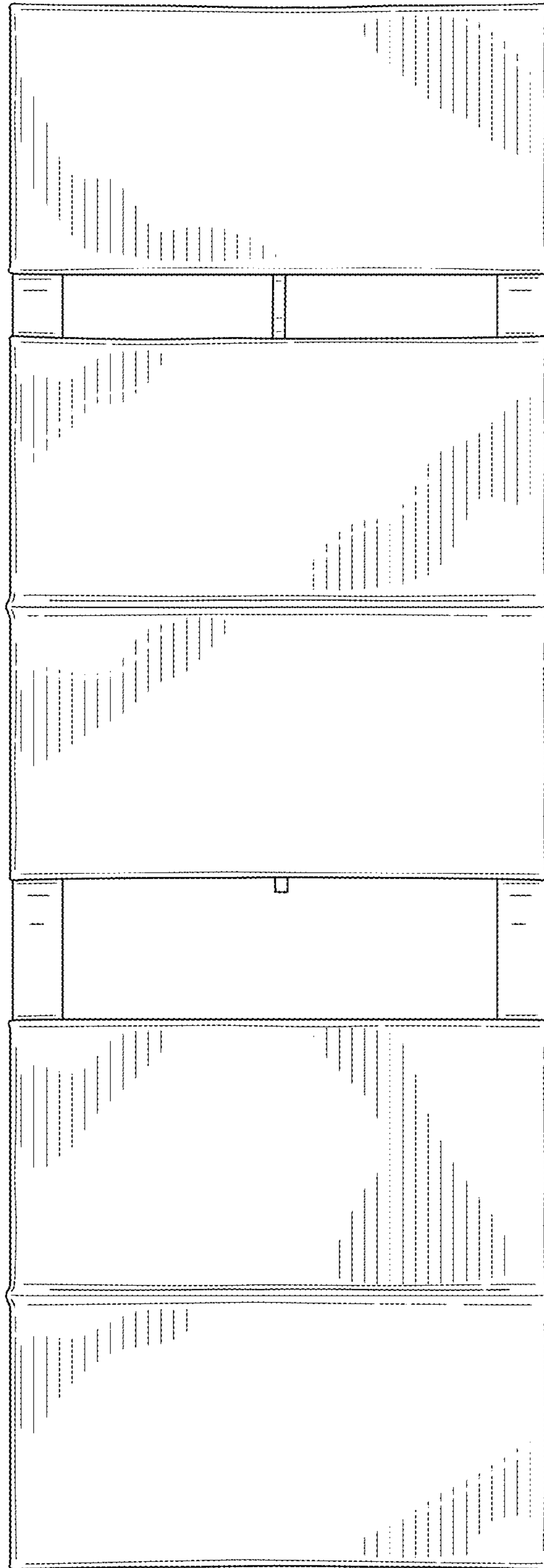

FIG. 2

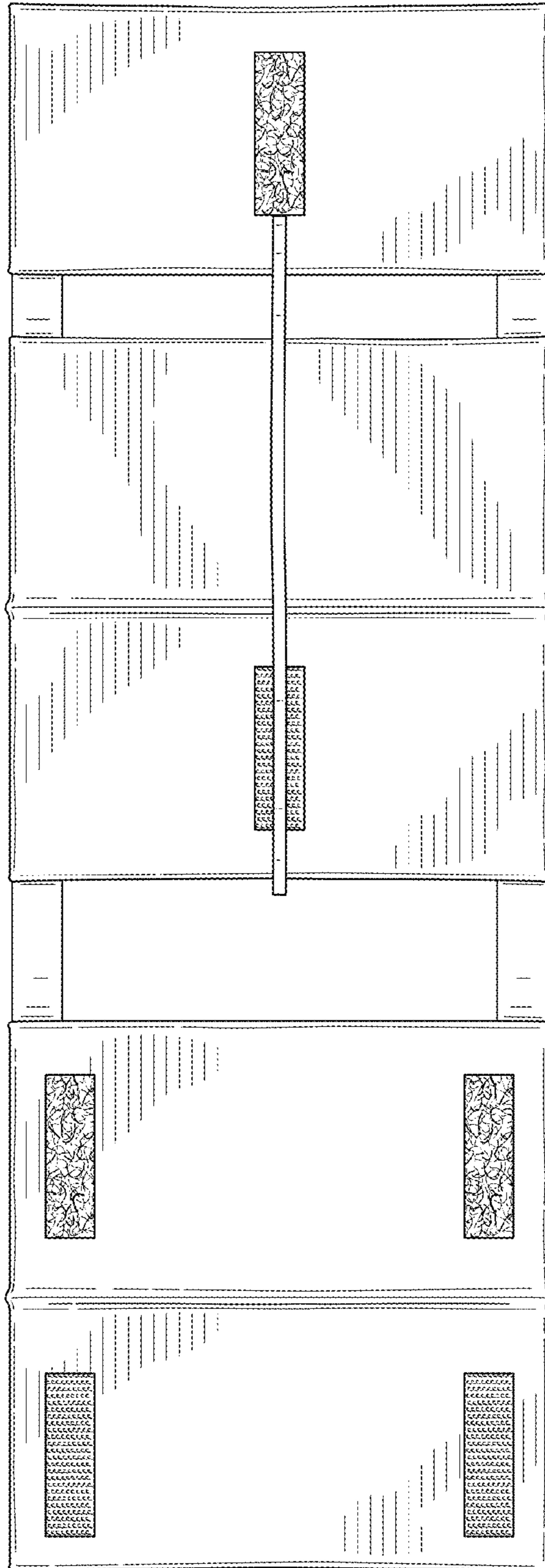

FIG. 3



FIG. 4



FIG. 5



FIG. 7



FIG. 6

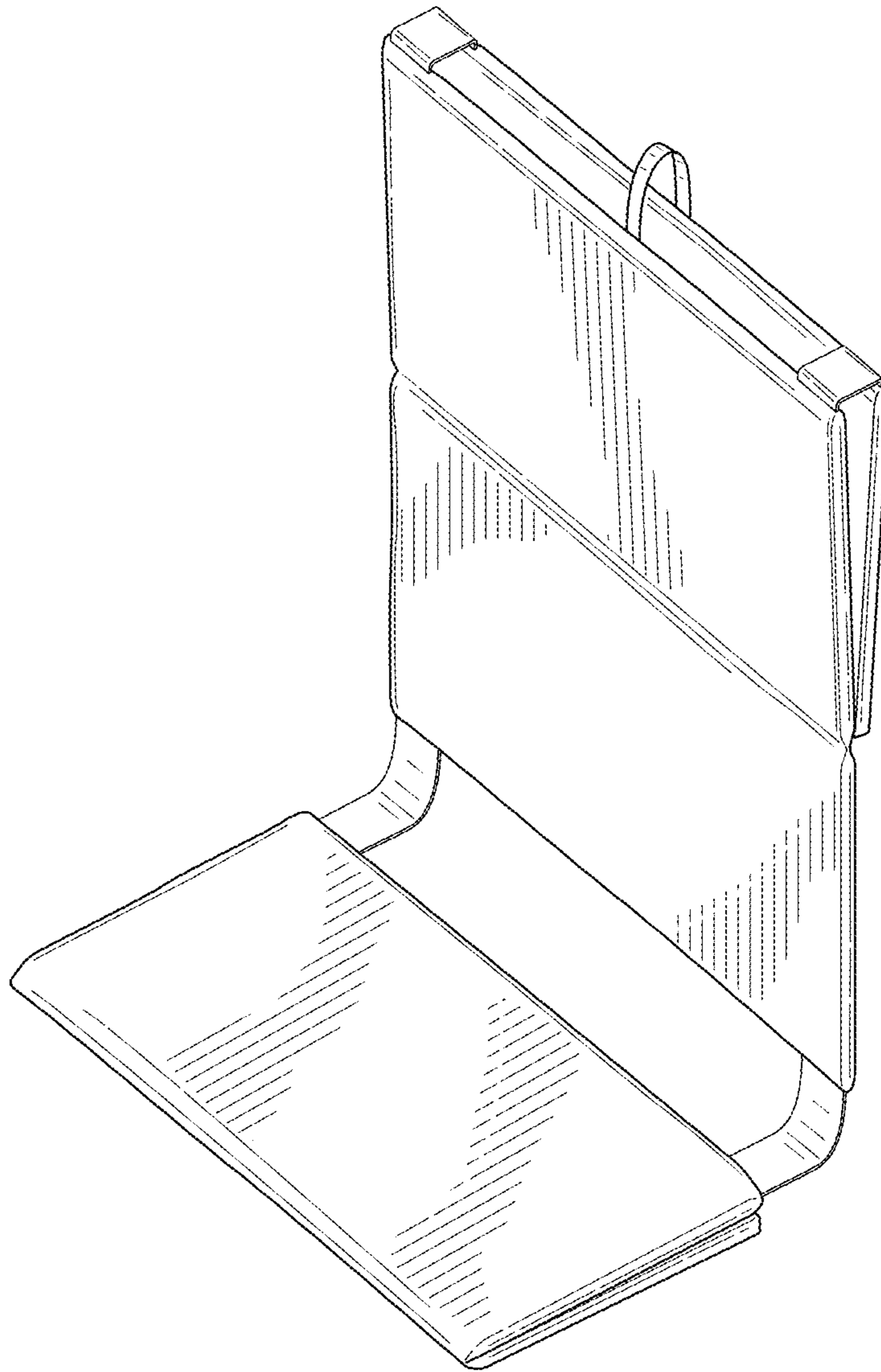

FIG. 8

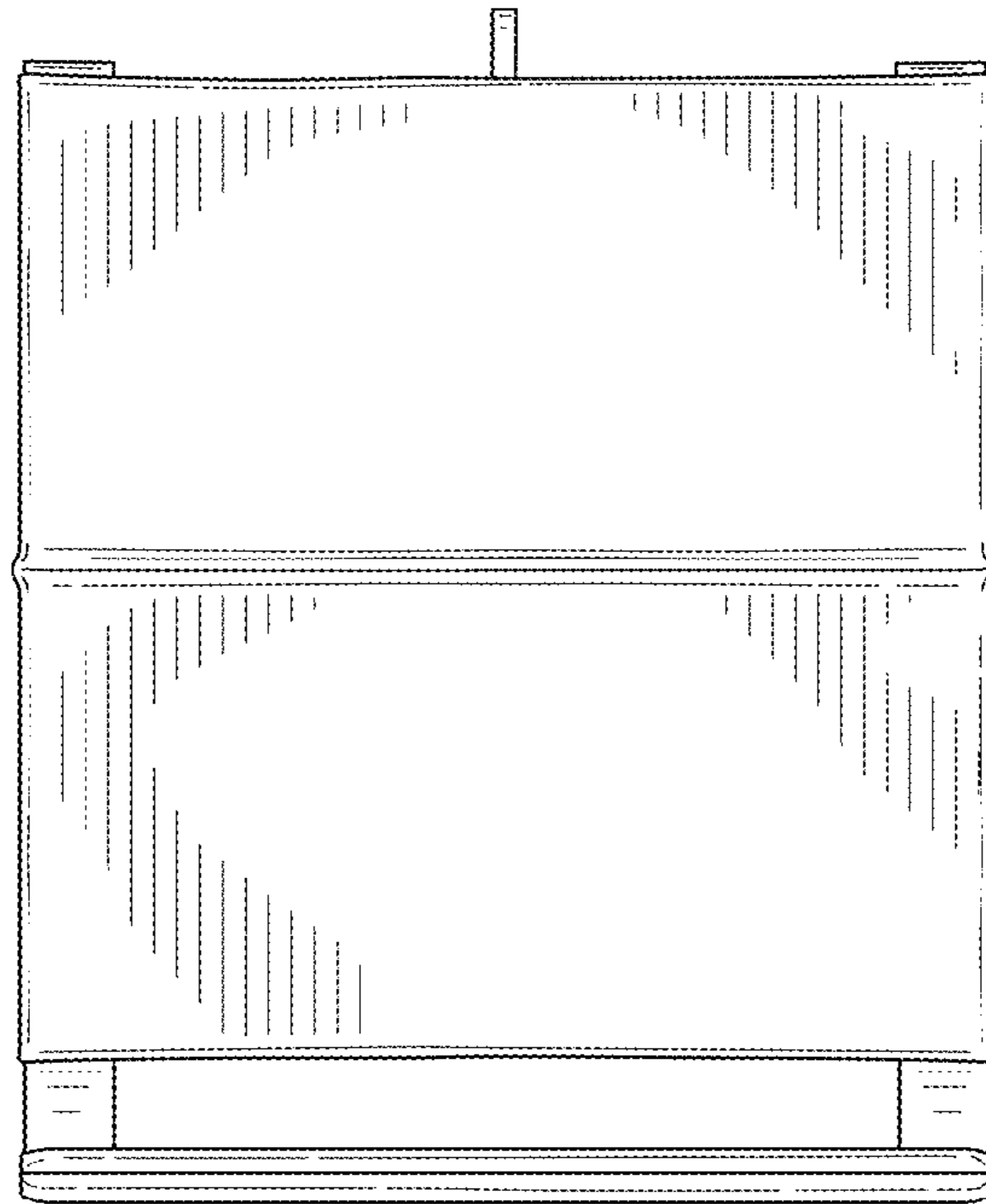

FIG. 9

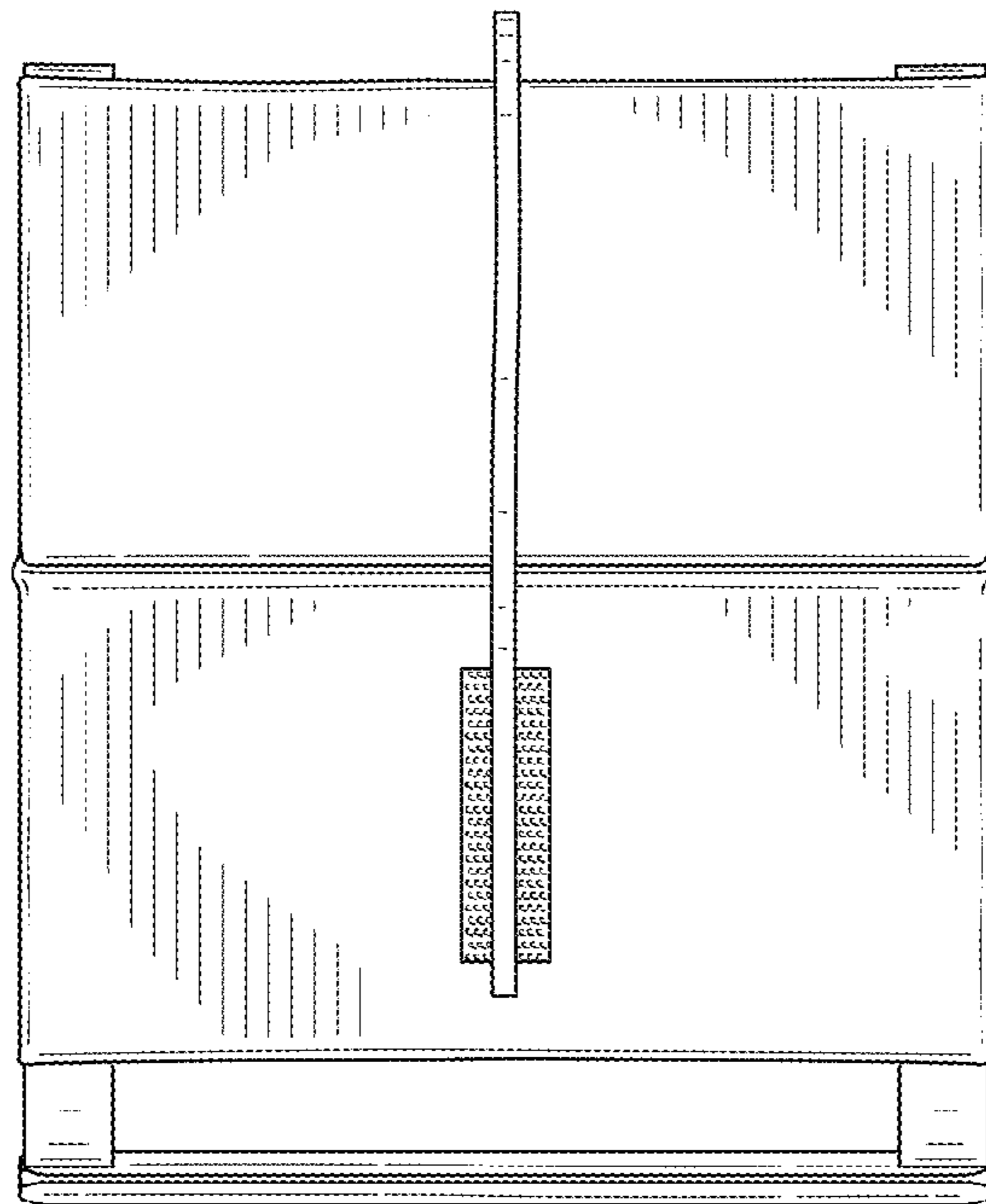

FIG. 10

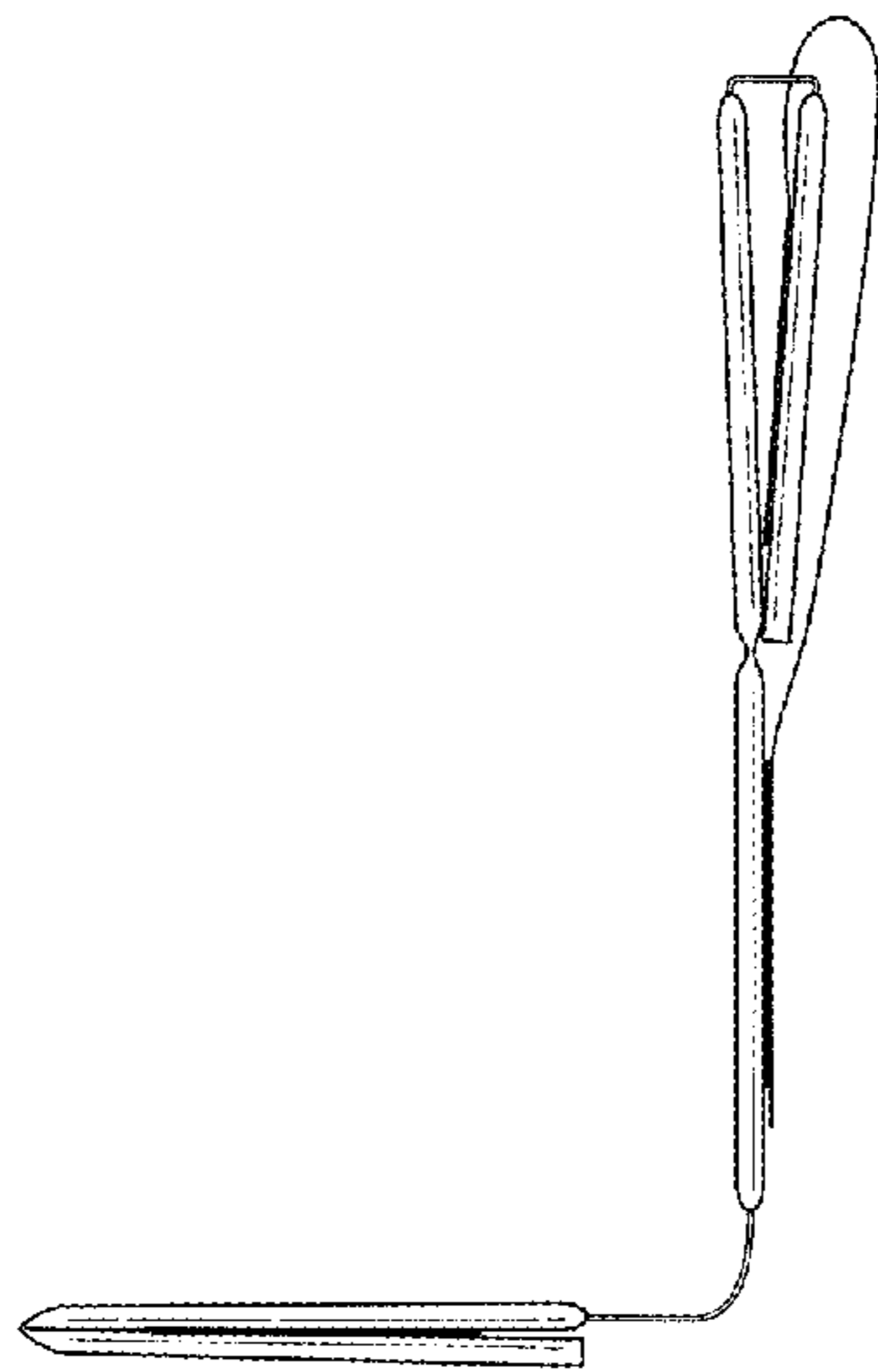

FIG. 11

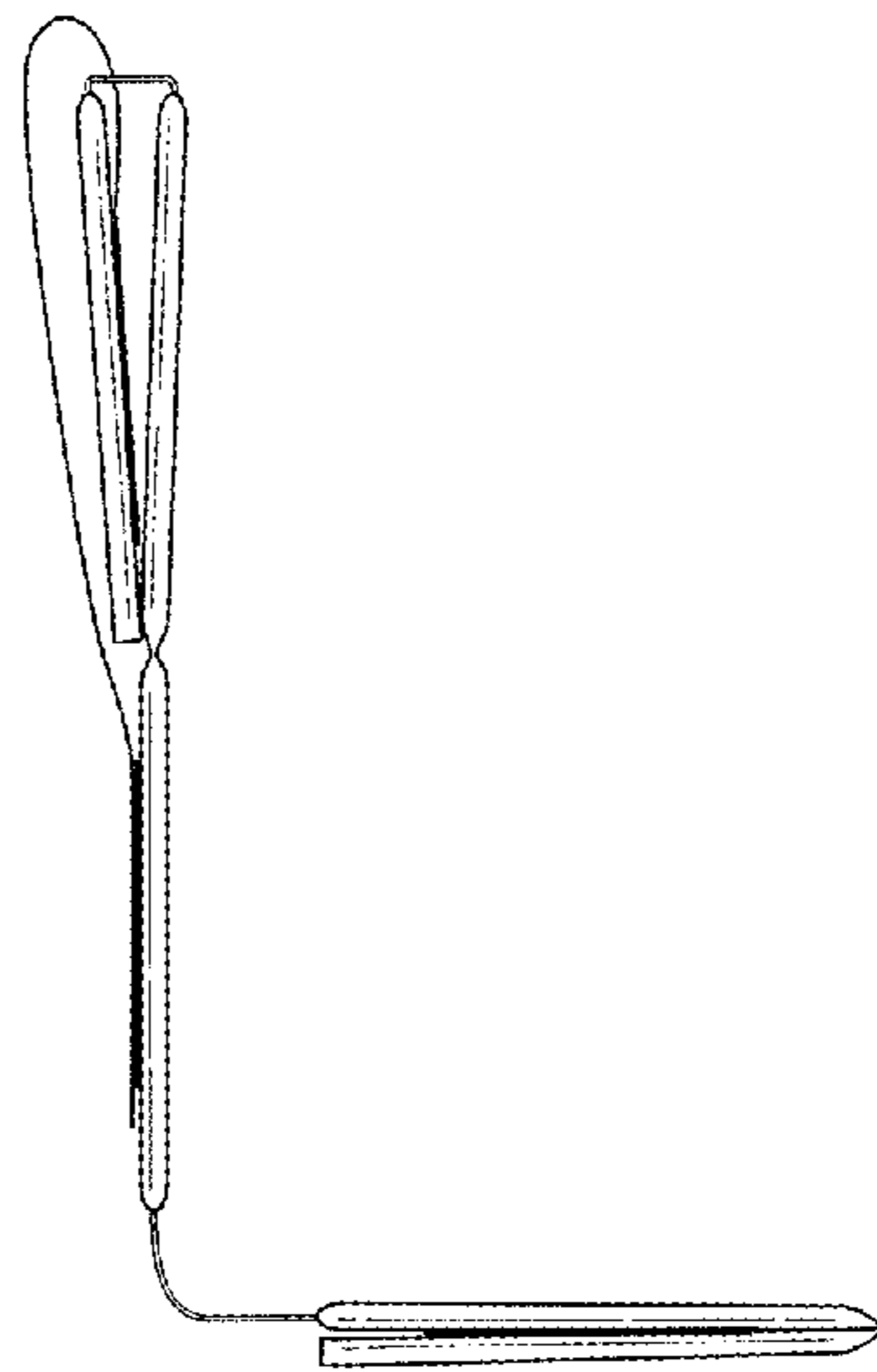
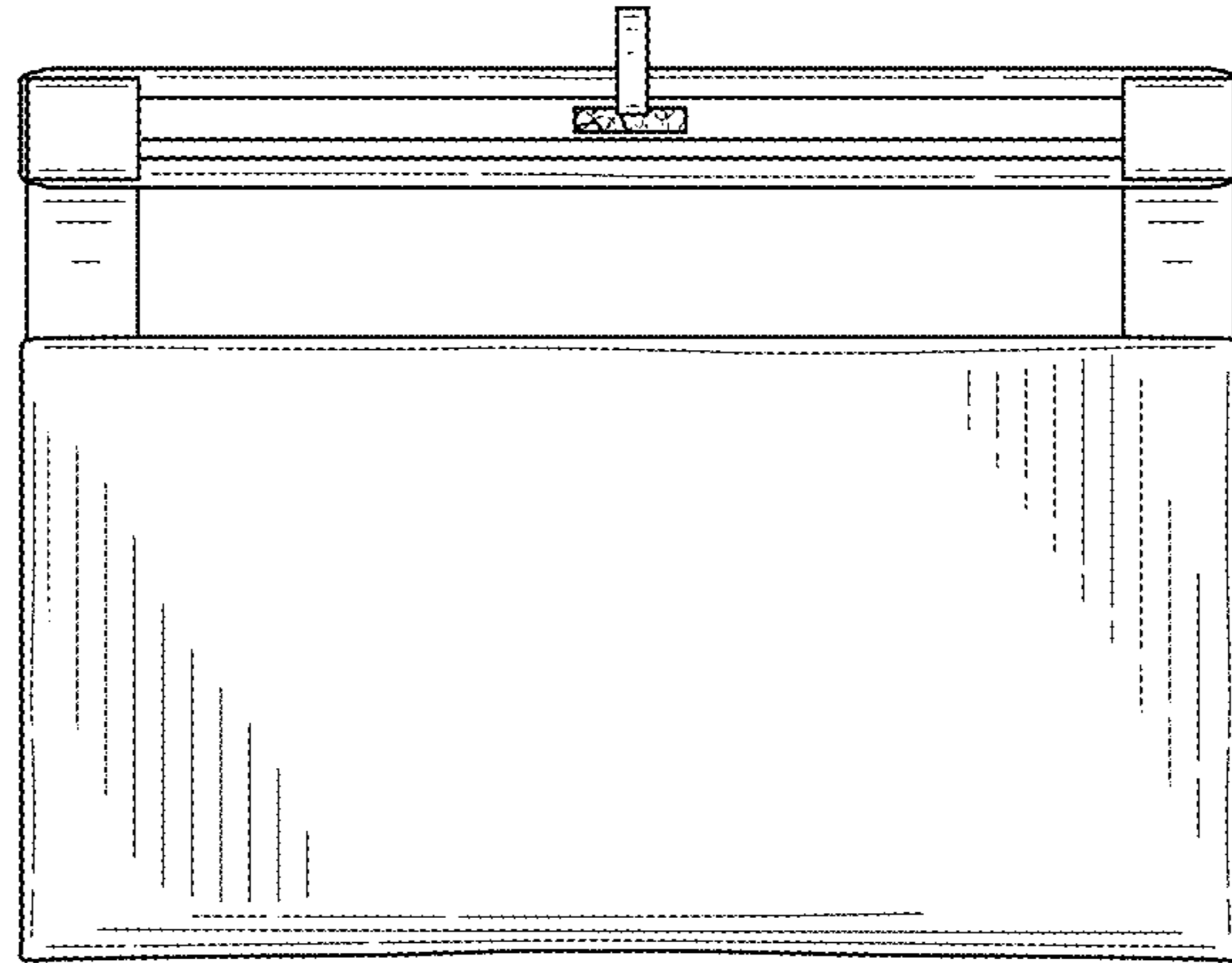
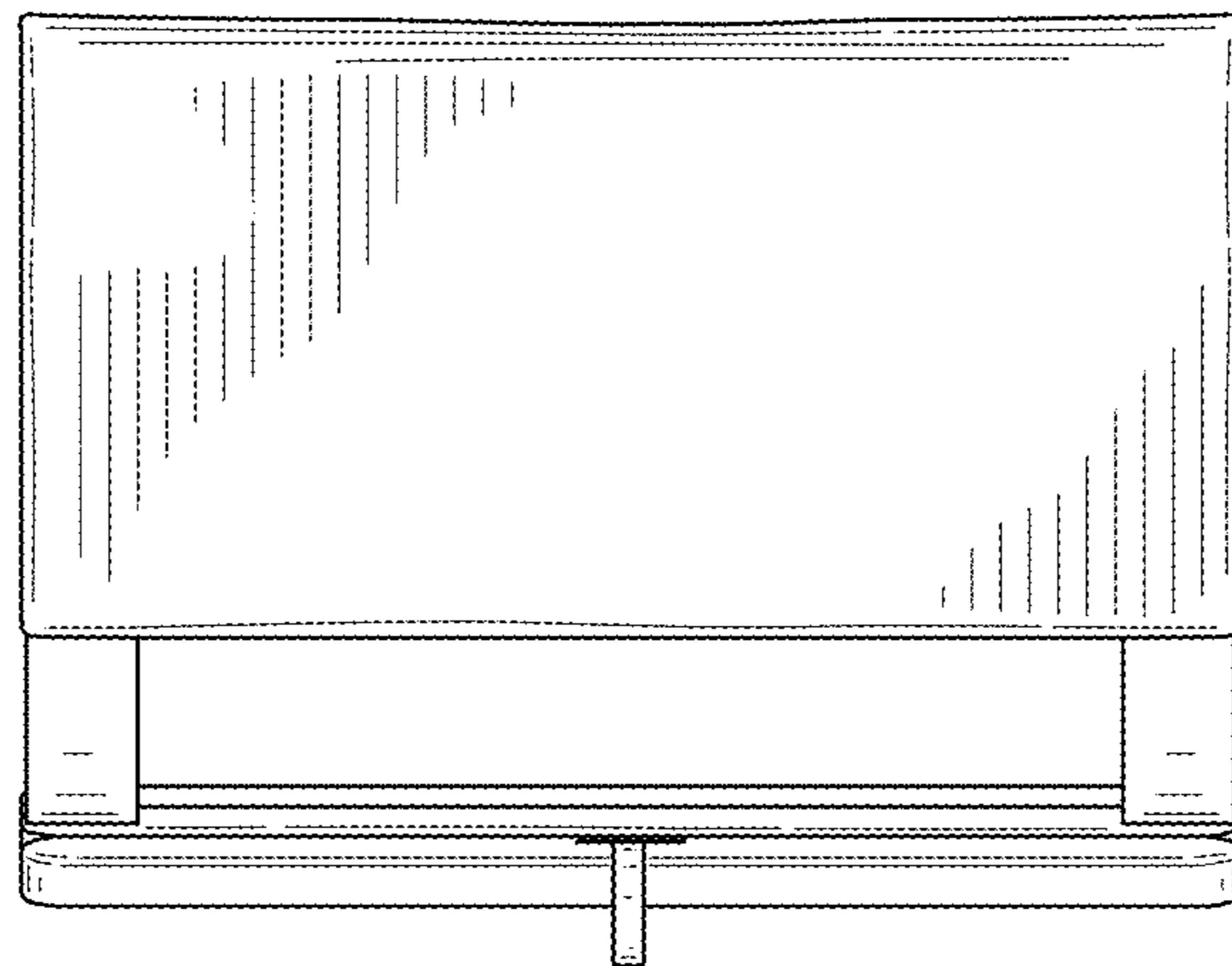

FIG. 12





**FIG. 13**



**FIG. 14**