



US00D765173S

(12) **United States Design Patent** (10) **Patent No.:** **US D765,173 S**
Mullen et al. (45) **Date of Patent:** **** *Aug. 30, 2016**

(54) **INTERACTIVE ELECTRONIC CARD WITH DISPLAY AND BUTTON**

4,720,860 A 1/1988 Weiss
4,786,791 A 11/1988 Hodama
4,791,283 A 12/1988 Burkhardt
4,797,542 A 1/1989 Hara
5,038,251 A 8/1991 Sugiyama et al.
5,168,520 A 12/1992 Weiss
5,237,614 A 8/1993 Weiss

(71) Applicant: **Dynamics Inc.**, Cheswick, PA (US)

(72) Inventors: **Jeffrey D. Mullen**, Pittsburgh, PA (US);
Eric R. Nicklaus, Pittsburgh, PA (US)

(Continued)

(73) Assignee: **DYNAMICS INC.**, Pittsburgh, PA (US)

FOREIGN PATENT DOCUMENTS

(*) Notice: This patent is subject to a terminal disclaimer.

JP 05210770 A 8/1993
WO WO9852735 11/1998

(Continued)

(**) Term: **14 Years**

OTHER PUBLICATIONS

(21) Appl. No.: **29/447,419**

U.S. Appl. No. 60/594,300, Poidomani et al.

(22) Filed: **Mar. 4, 2013**

(Continued)

(51) **LOC (10) Cl.** **19-08**

(52) **U.S. Cl.**
USPC **D19/10**

(58) **Field of Classification Search**
USPC D19/1-12, 20-34; 40/124.01-124.15,
40/672, 661, 726, 776; 283/72, 74, 75,
283/103, 105, 106; 206/449; D21/385;
D20/10, 22, 27, 40, 42, 11;
D14/435-437; 235/380, 449, 487, 492,
235/493, 494
CPC .. B42D 15/00; B42D 15/022; B42D 15/042;
B42D 15/045; B42D 15/027; B42D 25/00;
B42D 25/20; B42D 25/23; B42D 25/26;
B42D 25/29; B42D 25/30; B42D 25/285
See application file for complete search history.

Primary Examiner — Abraham Bahta

(57) **CLAIM**

The ornamental design for an interactive electronic card with display and button, as shown and described.

DESCRIPTION

FIG. 1 is a front, bottom, and left side perspective view of our new design for an interactive electronic card with display and button;
FIG. 2 is a back, top, and left side perspective view thereof;
FIG. 3 is a front side view thereof;
FIG. 4 is a back side view thereof;
FIG. 5 is a top side view thereof;
FIG. 6 is a bottom side view thereof;
FIG. 7 is a left side view thereof; and,
FIG. 8 is a right side view thereof.
The broken lines showing environment in the drawings are for illustrative purposes only and form no part of the claimed design.

(56) **References Cited**

U.S. PATENT DOCUMENTS

4,353,064 A 10/1982 Stamm
4,394,654 A 7/1983 Hofmann-Cerfontaine
4,614,861 A 9/1986 Pavlov et al.
4,667,087 A 5/1987 Quintana
4,701,601 A 10/1987 Francini et al.

1 Claim, 5 Drawing Sheets

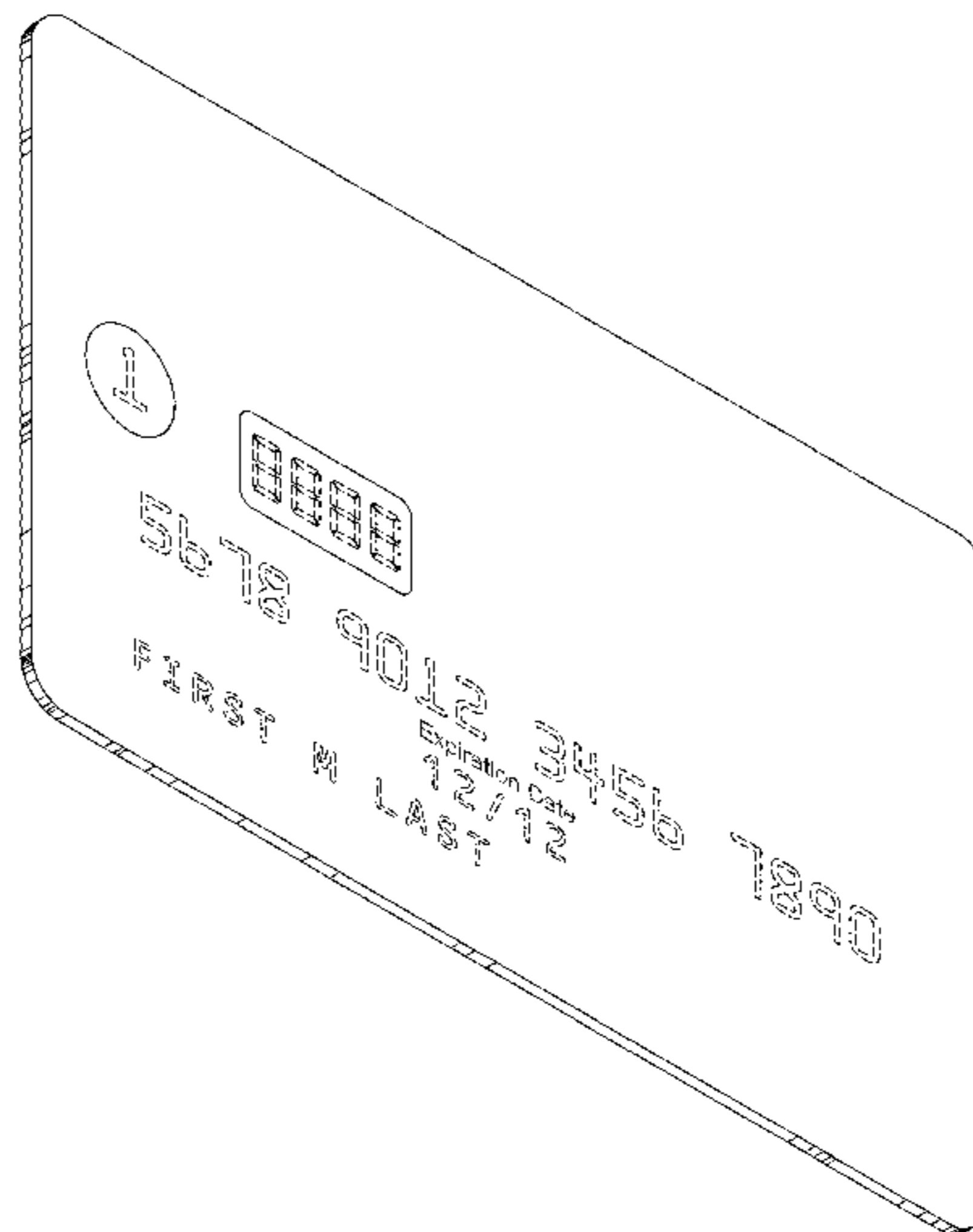

(56)

References Cited

U.S. PATENT DOCUMENTS

5,276,311 A	1/1994	Hennige	7,083,094 B2	8/2006	Cooper
5,347,580 A	9/1994	Molva et al.	7,100,049 B2	8/2006	Gasparini et al.
5,361,062 A	11/1994	Weiss et al.	7,100,821 B2	9/2006	Rasti
5,412,199 A	5/1995	Finkelstein et al.	7,111,172 B1	9/2006	Duane et al.
5,434,398 A	7/1995	Goldberg	7,114,652 B2	10/2006	Moulllette et al.
5,434,405 A	7/1995	Finkelstein et al.	7,136,514 B1	11/2006	Wong
5,478,994 A	12/1995	Rahman	7,140,550 B2	11/2006	Ramachandran
5,479,512 A	12/1995	Weiss	7,163,153 B2	1/2007	Blossom
5,484,997 A	1/1996	Haynes	7,195,154 B2	3/2007	Routhenstein
5,485,519 A	1/1996	Weiss	7,197,639 B1	3/2007	Juels et al.
5,585,787 A	12/1996	Wallerstein	7,219,368 B2	5/2007	Juels et al.
5,591,949 A	1/1997	Bernstein	7,225,537 B2	6/2007	Reed
5,608,203 A	3/1997	Finkelstein et al.	7,225,994 B2	6/2007	Finkelstein
5,623,552 A	4/1997	Lane	7,246,752 B2	7/2007	Brown
5,657,388 A	8/1997	Weiss	7,298,243 B2	11/2007	Juels et al.
5,834,747 A	11/1998	Cooper	7,334,732 B2	2/2008	Cooper
5,834,756 A	11/1998	Gutman et al.	7,337,326 B2	2/2008	Palmer et al.
5,856,661 A	1/1999	Finkelstein et al.	7,346,775 B2	3/2008	Gasparini et al.
5,864,623 A	1/1999	Messina et al.	7,356,696 B1	4/2008	Jakobsson et al.
5,907,142 A	5/1999	Kelsey	7,357,319 B1	4/2008	Lin et al.
5,913,203 A	6/1999	Wong et al.	7,359,507 B2	4/2008	Kaliski
5,937,394 A	8/1999	Wong et al.	7,360,688 B1	4/2008	Harris
5,955,021 A	9/1999	Tiffany, III	7,363,494 B2	4/2008	Brainard et al.
5,956,699 A	9/1999	Wong et al.	7,380,710 B2	6/2008	Brown
6,025,054 A	2/2000	Tiffany, III	7,398,253 B1	7/2008	Pinnell
6,045,043 A	4/2000	Bashan et al.	7,404,087 B2	7/2008	Teunen
6,076,163 A	6/2000	Hoffstein et al.	7,424,570 B2	9/2008	D'Albore et al.
6,085,320 A	7/2000	Kaliski	7,427,033 B1	9/2008	Roskind
6,095,416 A	8/2000	Grant et al.	7,454,349 B2	11/2008	Teunen et al.
6,130,621 A	10/2000	Weiss	7,461,250 B1	12/2008	Duane et al.
6,145,079 A	11/2000	Mitty et al.	7,461,399 B2	12/2008	Juels et al.
6,157,920 A	12/2000	Jakobsson et al.	7,472,093 B2	12/2008	Juels
6,161,181 A	12/2000	Haynes, III et al.	7,472,829 B2	1/2009	Brown
6,176,430 B1	1/2001	Finkelstein et al.	7,494,055 B2	2/2009	Fernandes et al.
6,182,894 B1	2/2001	Hackett et al.	7,502,467 B2	3/2009	Brainard et al.
6,189,098 B1	2/2001	Kaliski	7,502,933 B2	3/2009	Jakobsson et al.
6,199,052 B1	3/2001	Mitty et al.	7,503,485 B1	3/2009	Routhenstein
6,206,293 B1	3/2001	Gutman et al.	7,516,492 B1	4/2009	Nisbet et al.
6,240,184 B1	5/2001	Huynh et al.	7,523,301 B2	4/2009	Nisbet et al.
6,241,153 B1	6/2001	Tiffany, III	7,530,495 B2	5/2009	Cooper
6,256,873 B1	7/2001	Tiffany, III	7,532,104 B2	5/2009	Juels
6,269,163 B1	7/2001	Rivest et al.	7,543,739 B2	6/2009	Brown et al.
6,286,022 B1	9/2001	Kaliski et al.	7,559,464 B2	7/2009	Routhenstein
6,308,890 B1	10/2001	Cooper	7,562,221 B2	7/2009	Nystrom et al.
6,313,724 B1	11/2001	Osterweil	7,562,222 B2	7/2009	Gasparini et al.
6,389,442 B1	5/2002	Yin et al.	7,580,898 B2	8/2009	Brown et al.
6,393,447 B1	5/2002	Jakobsson et al.	7,584,153 B2	9/2009	Brown et al.
6,411,715 B1	6/2002	Liskov et al.	7,591,426 B2	9/2009	Osterweil et al.
6,446,052 B1	9/2002	Juels	7,591,427 B2	9/2009	Osterweil
6,460,141 B1	10/2002	Olden	7,602,904 B2	10/2009	Juels et al.
6,592,044 B1	7/2003	Wong et al.	7,631,804 B2	12/2009	Brown
6,607,127 B2	8/2003	Wong	7,639,537 B2	12/2009	Sepe et al.
6,609,654 B1	8/2003	Anderson et al.	7,641,124 B2	1/2010	Brown et al.
6,631,849 B2	10/2003	Blossom	7,660,902 B2	2/2010	Graham et al.
6,655,585 B2	12/2003	Shinn	7,828,207 B2	11/2010	Cooper
6,681,988 B2	1/2004	Stack et al.	D675,256 S *	1/2013	Mullen et al. D19/10
6,705,520 B1	3/2004	Pitroda et al.	D676,487 S *	2/2013	Mullen et al. D19/10
6,755,341 B1	6/2004	Wong et al.	D687,487 S *	8/2013	Mullen et al. D19/10
6,764,005 B2	7/2004	Cooper	D687,488 S *	8/2013	Mullen et al. D19/10
6,769,618 B1	8/2004	Finkelstein	D687,489 S *	8/2013	Mullen et al. D19/10
6,805,288 B2	10/2004	Routhenstein et al.	D687,490 S *	8/2013	Mullen et al. D19/10
6,811,082 B2	11/2004	Wong	D687,887 S *	8/2013	Mullen et al. D19/10
6,813,354 B1	11/2004	Jakobsson et al.	D688,744 S *	8/2013	Mullen et al. D19/10
6,817,532 B2	11/2004	Finkelstein	D692,053 S *	10/2013	Mullen et al. D19/10
6,873,974 B1	3/2005	Schutzer	D694,322 S *	11/2013	Mullen et al. D19/10
6,902,116 B2	6/2005	Finkelstein	2001/0034702 A1	10/2001	Mockett et al.
6,970,070 B2	11/2005	Juels et al.	2001/0047335 A1	11/2001	Arndt et al.
6,980,969 B1	12/2005	Tuchler et al.	2002/0059114 A1	5/2002	Cockrill et al.
6,985,583 B1	1/2006	Brainard et al.	2002/0082989 A1	6/2002	Fife et al.
6,991,155 B2	1/2006	Burchette, Jr.	2002/0096570 A1	7/2002	Wong et al.
7,013,030 B2	3/2006	Wong et al.	2002/0120583 A1	8/2002	Keresman, III et al.
7,035,443 B2	4/2006	Wong	2003/0034388 A1	2/2003	Routhenstein et al.
7,039,223 B2	5/2006	Wong	2003/0052168 A1	3/2003	Wong
7,044,394 B2	5/2006	Brown	2003/0057278 A1	3/2003	Wong
7,051,929 B2	5/2006	Li	2003/0116635 A1	6/2003	Taban
			2003/0152253 A1	8/2003	Wong
			2003/0163287 A1	8/2003	Vock et al.
			2003/0173409 A1	9/2003	Vogt et al.
			2003/0179909 A1	9/2003	Wong et al.

(56)

References Cited

U.S. PATENT DOCUMENTS

2003/0179910 A1 9/2003 Wong
 2003/0226899 A1 12/2003 Finkelstein
 2004/0035942 A1 2/2004 Silverman
 2004/0133787 A1 7/2004 Doughty
 2004/0162732 A1 8/2004 Rahim et al.
 2004/0172535 A1 9/2004 Jakobsson
 2004/0177045 A1 9/2004 Brown
 2005/0043997 A1 2/2005 Sohata et al.
 2005/0080747 A1 4/2005 Anderson et al.
 2005/0086160 A1 4/2005 Wong et al.
 2005/0086177 A1 4/2005 Anderson et al.
 2005/0116026 A1 6/2005 Burger et al.
 2005/0119940 A1 6/2005 Concilio et al.
 2005/0154643 A1 7/2005 Doan et al.
 2005/0228959 A1 10/2005 D'Albore et al.
 2006/0000900 A1 1/2006 Fernandes et al.
 2006/0037073 A1 2/2006 Juels et al.
 2006/0041759 A1 2/2006 Kaliski et al.
 2006/0085328 A1 4/2006 Cohen et al.
 2006/0091223 A1 5/2006 Zellner
 2006/0161435 A1 7/2006 Atef et al.
 2006/0163353 A1 7/2006 Moulette et al.
 2006/0174104 A1 8/2006 Crichton et al.
 2006/0196931 A1 9/2006 Holtmanns et al.
 2006/0256961 A1 11/2006 Brainard et al.
 2007/0034700 A1 2/2007 Poidomani et al.
 2007/0114274 A1 5/2007 Gibbs et al.
 2007/0124321 A1 5/2007 Szydlo
 2007/0152070 A1 7/2007 D'Albore
 2007/0152072 A1 7/2007 Frallicciardi et al.
 2007/0153487 A1 7/2007 Frallicciardi et al.
 2007/0174614 A1 7/2007 Duane et al.
 2007/0192249 A1 8/2007 Biffle et al.
 2007/0241183 A1 10/2007 Brown et al.
 2007/0241201 A1 10/2007 Brown et al.
 2007/0256123 A1 11/2007 Duane et al.
 2007/0291753 A1 12/2007 Romano
 2008/0005510 A1 1/2008 Sepe et al.
 2008/0008315 A1 1/2008 Fontana et al.
 2008/0008322 A1 1/2008 Fontana et al.
 2008/0010675 A1 1/2008 Massascusa et al.
 2008/0016351 A1 1/2008 Fontana et al.
 2008/0019507 A1 1/2008 Fontana et al.
 2008/0028447 A1 1/2008 O'Malley et al.

2008/0040271 A1 2/2008 Hammad et al.
 2008/0040276 A1 2/2008 Hammad et al.
 2008/0058016 A1 3/2008 Di Maggio et al.
 2008/0059379 A1 3/2008 Ramaci et al.
 2008/0096326 A1 4/2008 Reed
 2008/0126398 A1 5/2008 Cimino
 2008/0128515 A1 6/2008 Di Iorio
 2008/0148394 A1 6/2008 Poidomani et al.
 2008/0201264 A1 8/2008 Brown et al.
 2008/0209550 A1 8/2008 Di Iorio
 2008/0288699 A1 11/2008 Chichierchia
 2008/0294930 A1 11/2008 Varone et al.
 2008/0302877 A1 12/2008 Musella et al.
 2009/0013122 A1 1/2009 Sepe et al.
 2009/0036147 A1 2/2009 Romano
 2009/0046522 A1 2/2009 Sepe et al.
 2009/0108064 A1 4/2009 Fernandes et al.
 2009/0150295 A1 6/2009 Hatch et al.
 2009/0152365 A1 6/2009 Li et al.
 2009/0242648 A1 10/2009 Di Sirio et al.
 2009/0244858 A1 10/2009 Di Sirio et al.
 2009/0253460 A1 10/2009 Varone et al.
 2009/0255996 A1 10/2009 Brown et al.
 2009/0290704 A1 11/2009 Cimino
 2009/0303885 A1 12/2009 Longo
 2011/0028184 A1 2/2011 Cooper

FOREIGN PATENT DOCUMENTS

WO WO0247019 6/2002
 WO WO2006066322 6/2006
 WO WO2006080929 8/2006
 WO WO2006105092 10/2006
 WO WO2006116772 11/2006
 WO WO2008064403 6/2008

OTHER PUBLICATIONS

U.S. Appl. No. 60/675,388, Poidomani et al.
 The Bank Credit Card Business. Second Edition, American Bankers Association, Washington, D.C., 1996.
 A Day in the Life of a Flux Reversal. <http://www.phrack.org/issues.html?issue=37&id=6#article>. As viewed on Apr. 12, 2010.
 Dynamic Virtual Credit Card Numbers. <http://homes.cerias.purdue.edu/~jtli/paper/fc07.pdf>. As viewed on Apr. 12, 2010.
 English translation of JP 05210770 A.

* cited by examiner

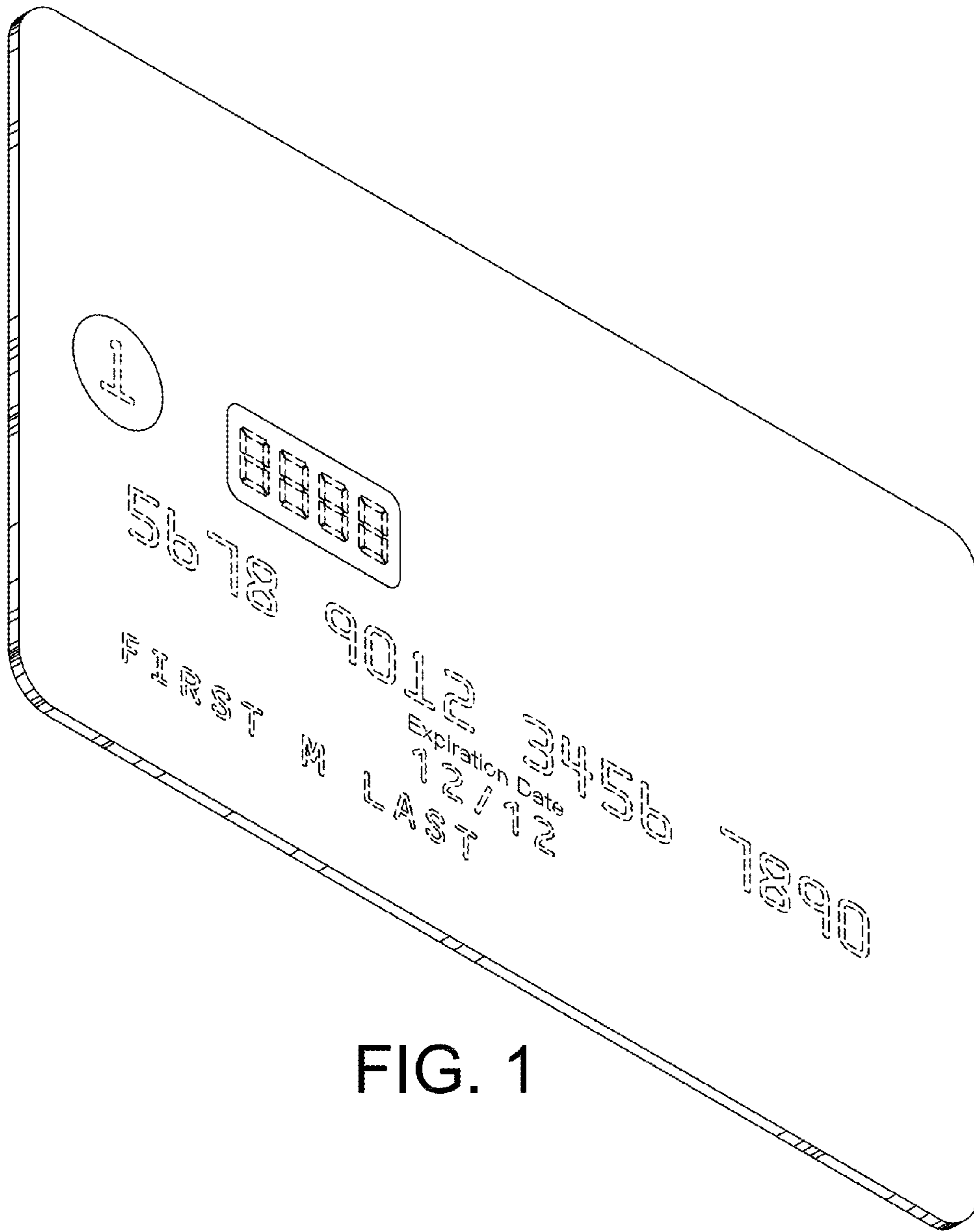

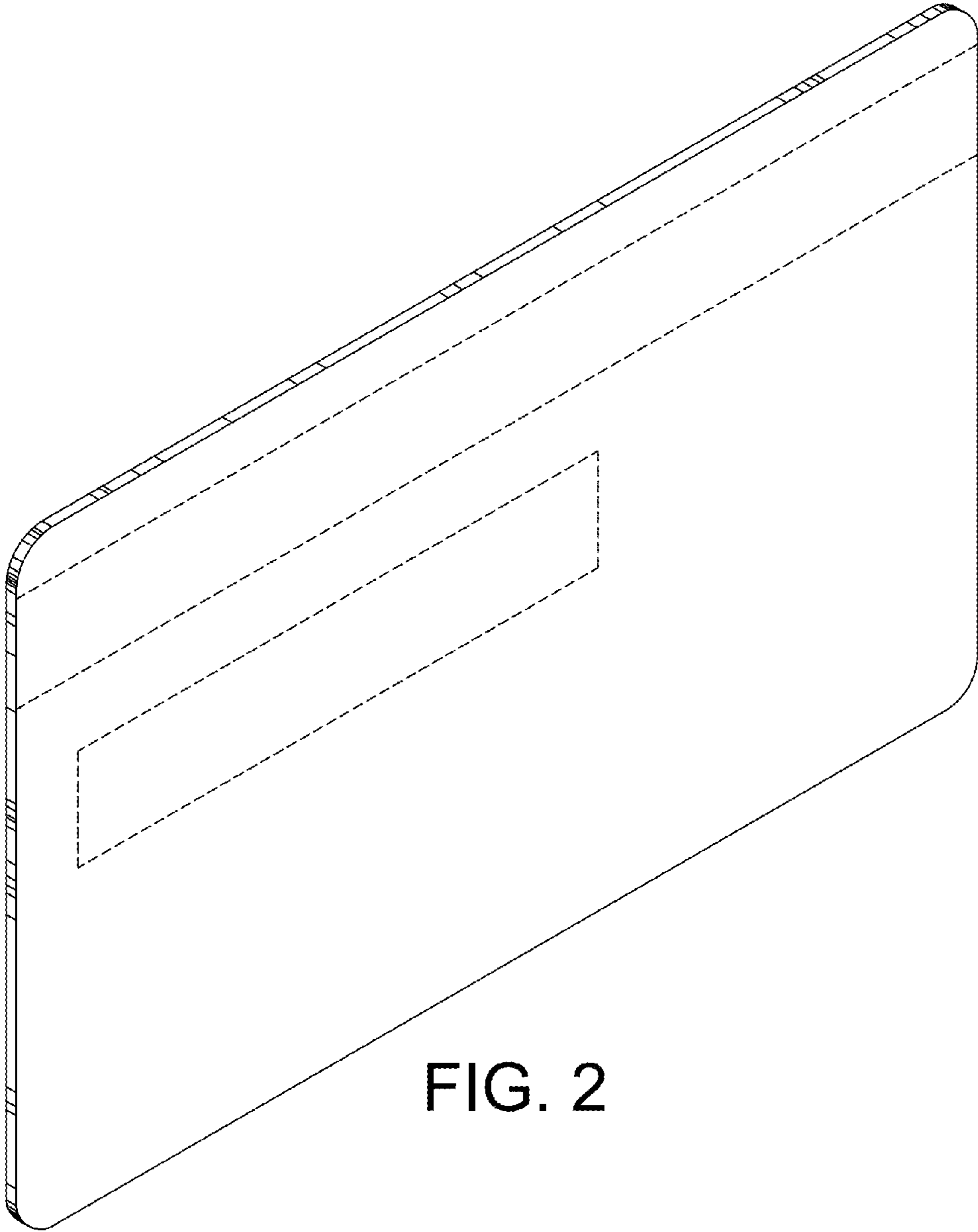

FIG. 2

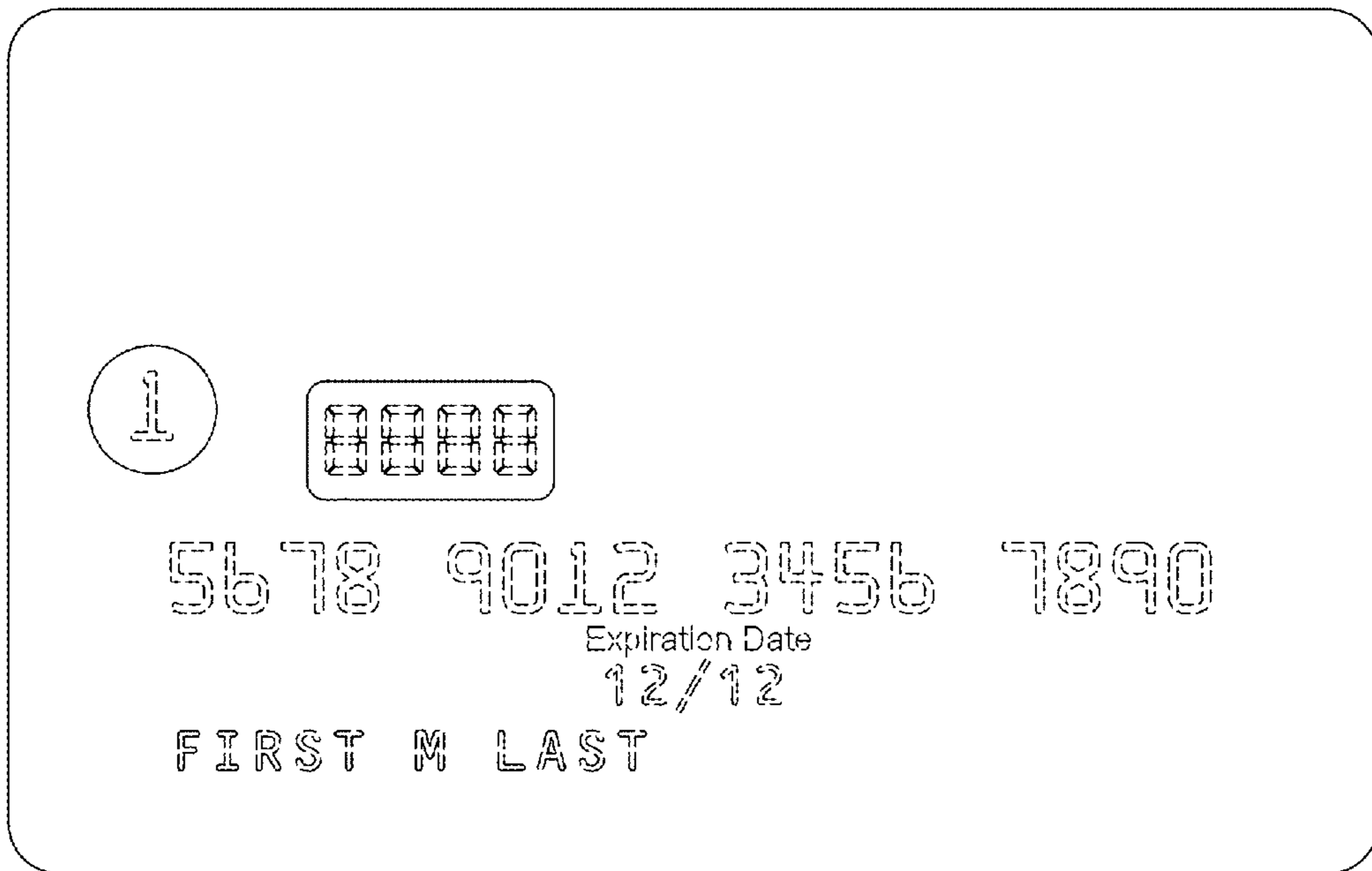

FIG. 3

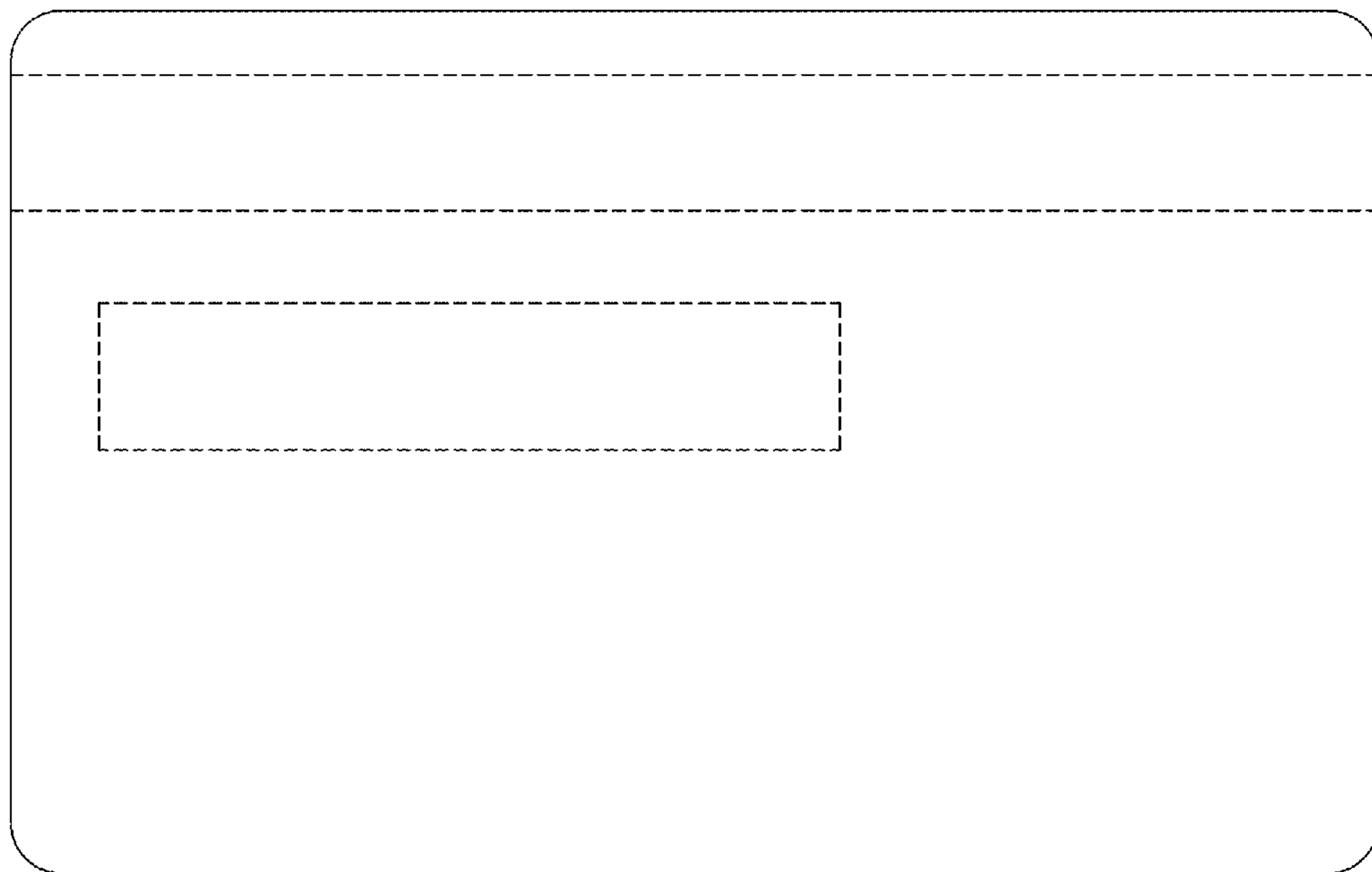

FIG. 4

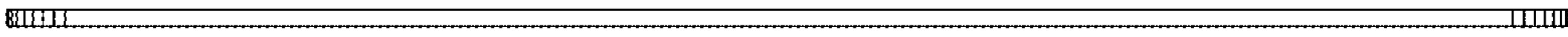

FIG. 5

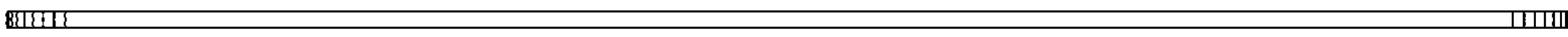

FIG. 6



FIG. 7

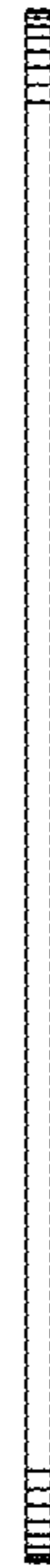

FIG. 8