



US00D765072S

(12) **United States Design Patent** (10) **Patent No.:** **US D765,072 S**
Kwon (45) **Date of Patent:** **** Aug. 30, 2016**

(54) **SMART WATCH**

(71) Applicant: **Lenovo (Beijing) Co., Ltd.**, Beijing (CN)

(72) Inventor: **Jincherl Kwon**, Beijing (CN)

(73) Assignee: **Lenovo (Beijing) Co., Ltd.**, Beijing (CN)

(**) Term: **14 Years**

(21) Appl. No.: **29/519,874**

(22) Filed: **Mar. 9, 2015**

(30) **Foreign Application Priority Data**

Sep. 9, 2014 (CN) 2014 3 0331720

(51) **LOC (10) Cl.** **14-02**

(52) **U.S. Cl.**
USPC **D14/344**; D10/70; D10/78; D10/98;
D10/38; D24/167

(58) **Field of Classification Search**
USPC D10/30-39, 65, 70, 78, 97, 98; D11/3;
D14/138 R, 203.5, 203.6, 341, 344,
D14/347; D24/167, 168
CPC A44C 5/00-5/16; G04B 37/00-37/228;
G04B 45/0069; G04B 47/04; G04B
19/00-19/34; G04B 21/12; G04B 23/12;
G04B 47/00-47/068; G01C 17/00; G01C
21/00-21/3697

See application file for complete search history.

(56) **References Cited**

U.S. PATENT DOCUMENTS

D737,156 S	*	8/2015	Akana	D10/32
D737,157 S	*	8/2015	Akana	D10/32
D737,158 S	*	8/2015	Akana	D10/32
D737,159 S	*	8/2015	Akana	D10/32
D741,726 S	*	10/2015	Akana	D10/30
D744,356 S	*	12/2015	Akana	D10/70
D745,421 S	*	12/2015	Akana	D10/32
D746,707 S	*	1/2016	Akana	D10/39

* cited by examiner

Primary Examiner — Antoine D Davis

(74) *Attorney, Agent, or Firm* — Oppedahl Patent Law Firm LLC

(57) **CLAIM**

The ornamental design for a smart watch, as shown and described.

DESCRIPTION

FIG. 1 is a front view.
FIG. 2 is a rear view.
FIG. 3 is a left side view.
FIG. 4 is a right side view.
FIG. 5 is a top view.
FIG. 6 is a bottom view; and,
FIG. 7 is a perspective view.
The features shown in broken lines in the drawing depict environmental subject matter and unclaimed borders and form no part of the claimed design.

1 Claim, 7 Drawing Sheets

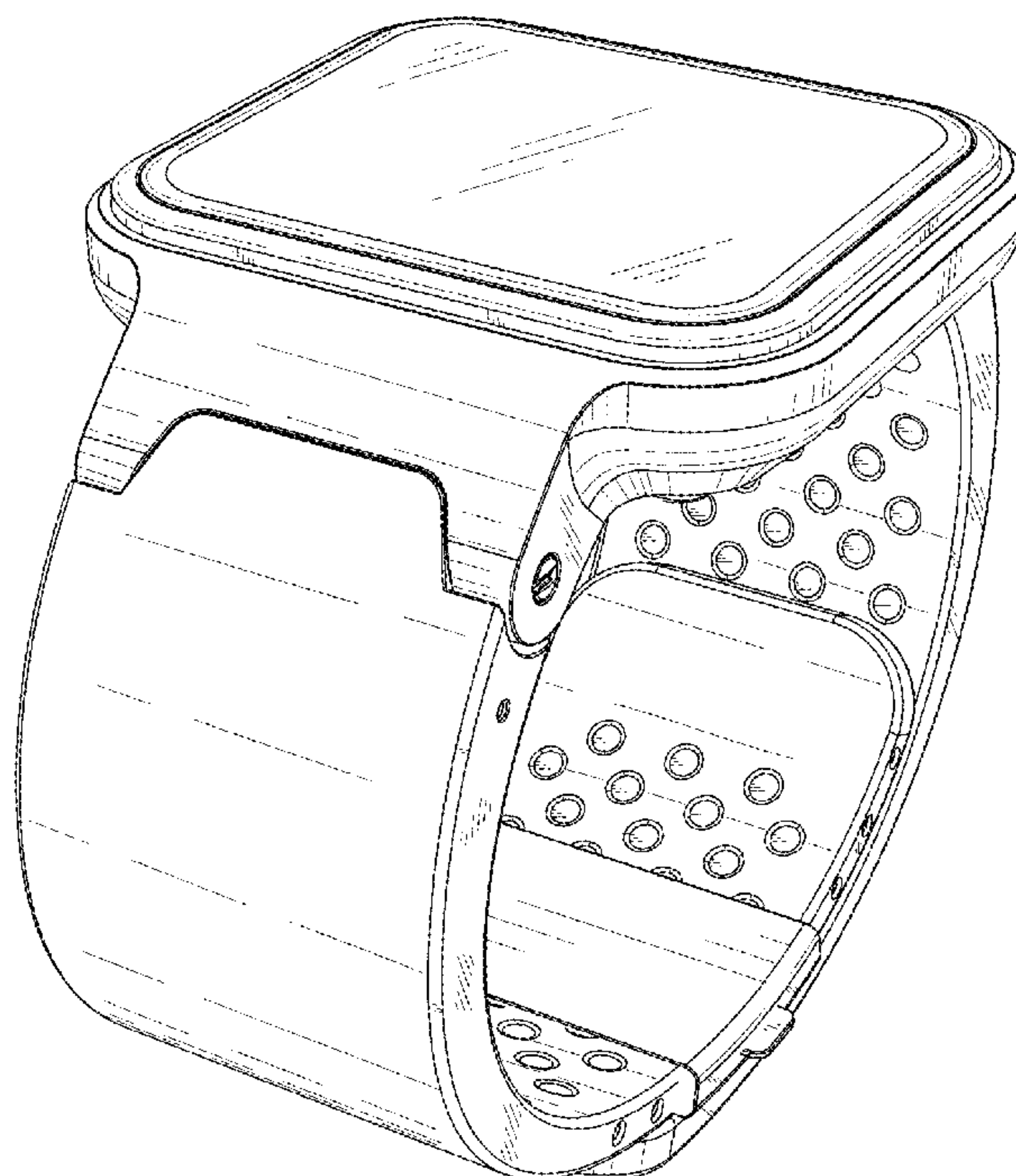

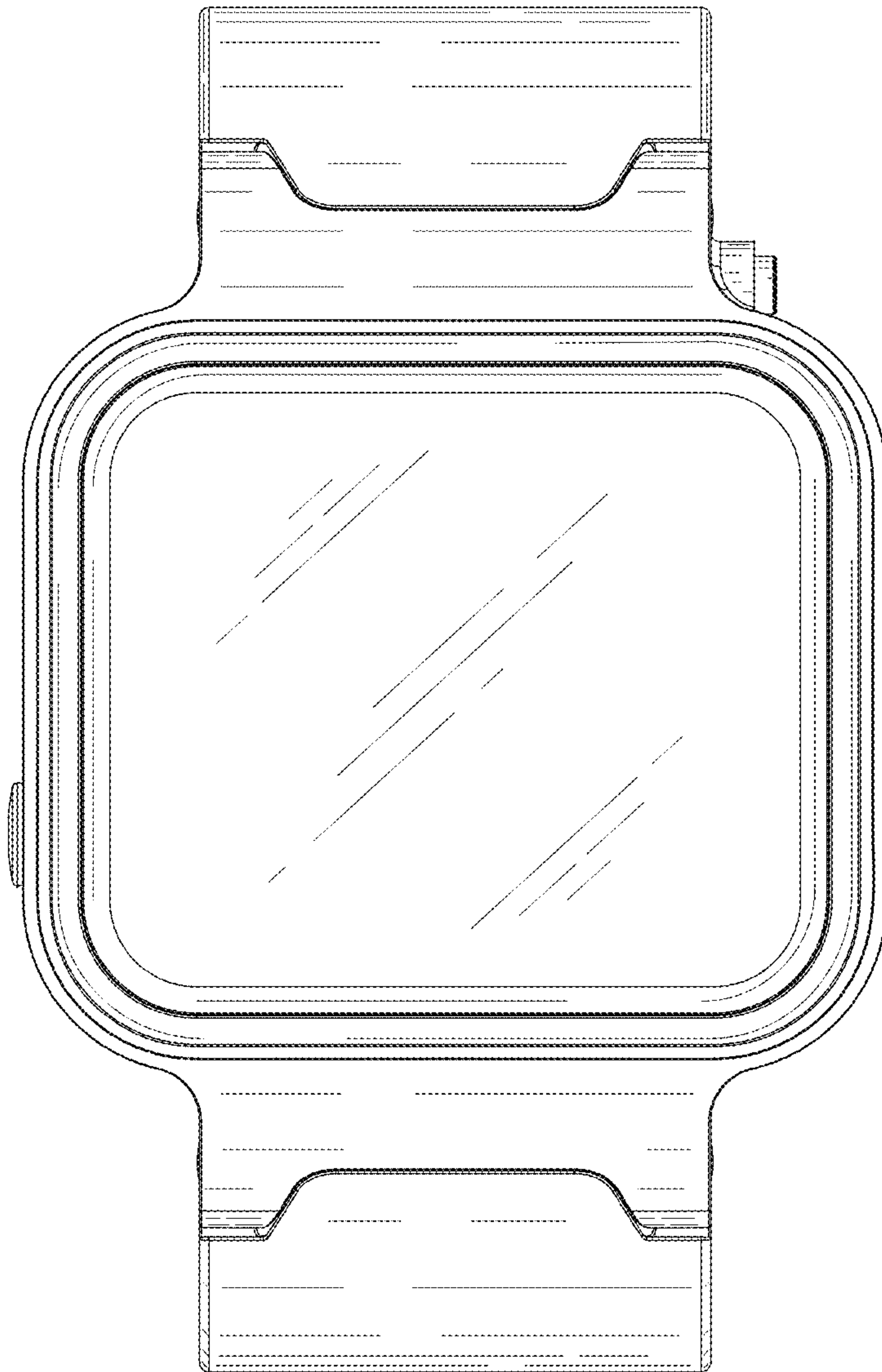

Figure 1

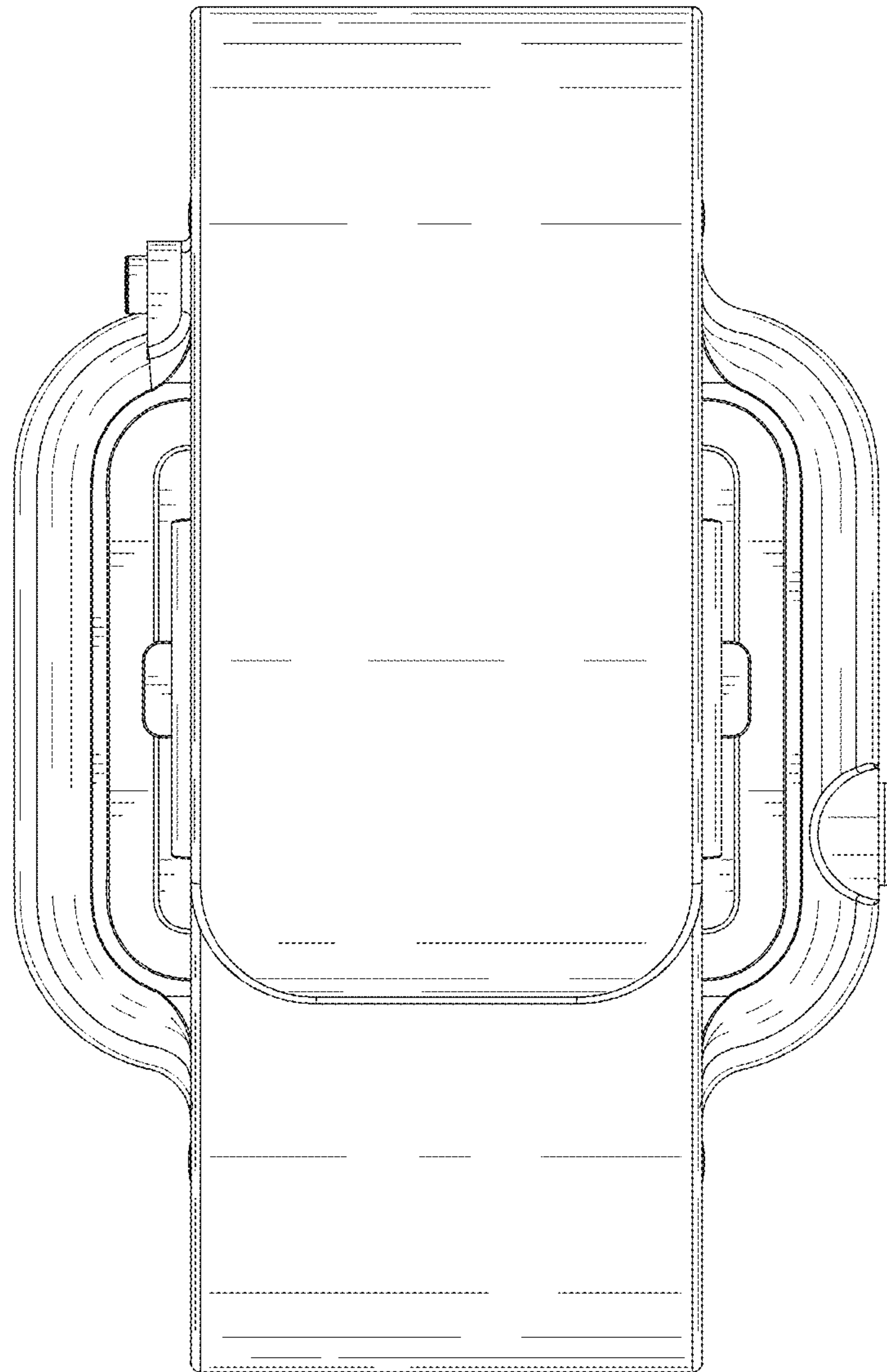

Figure 2

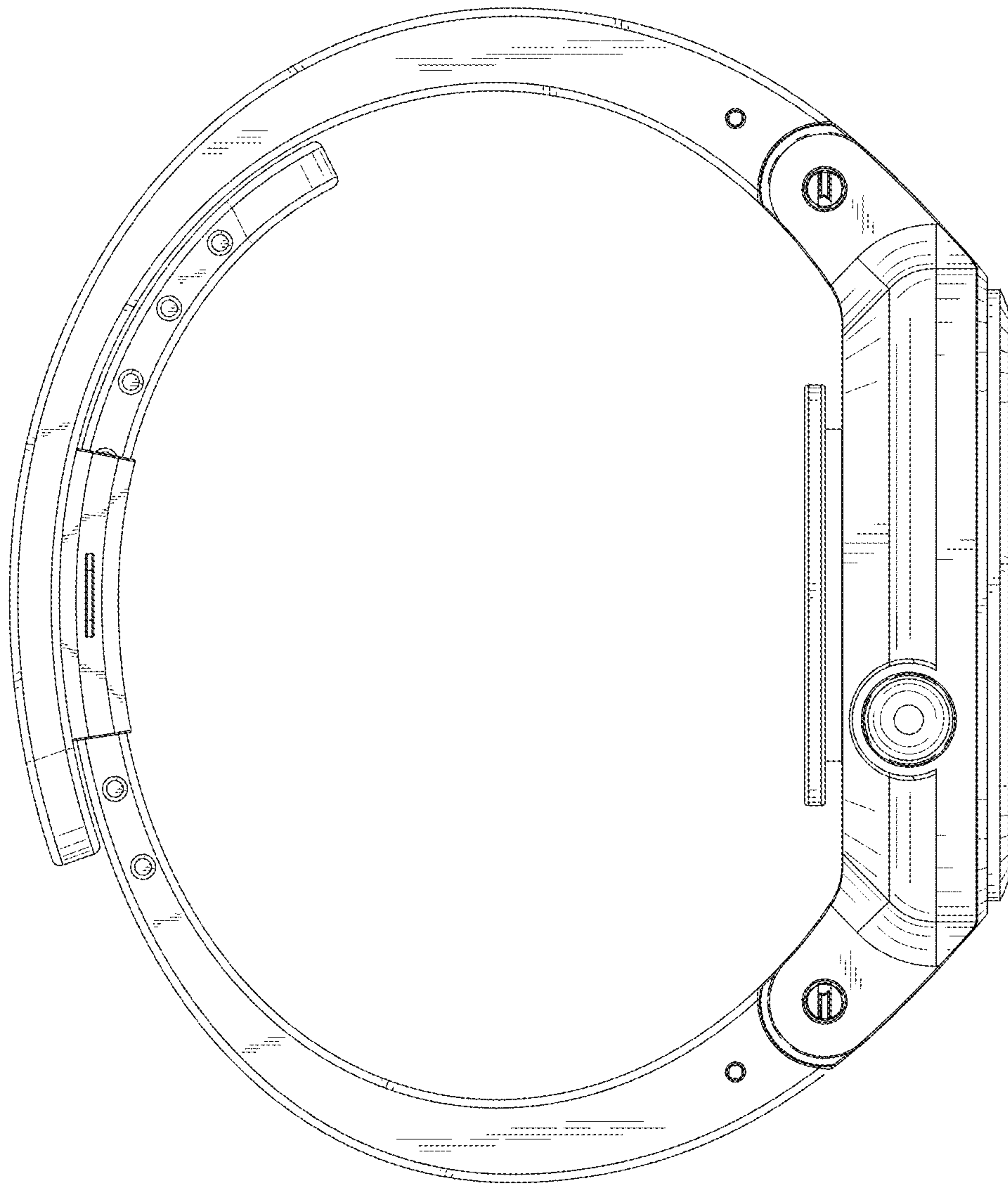

Figure 3

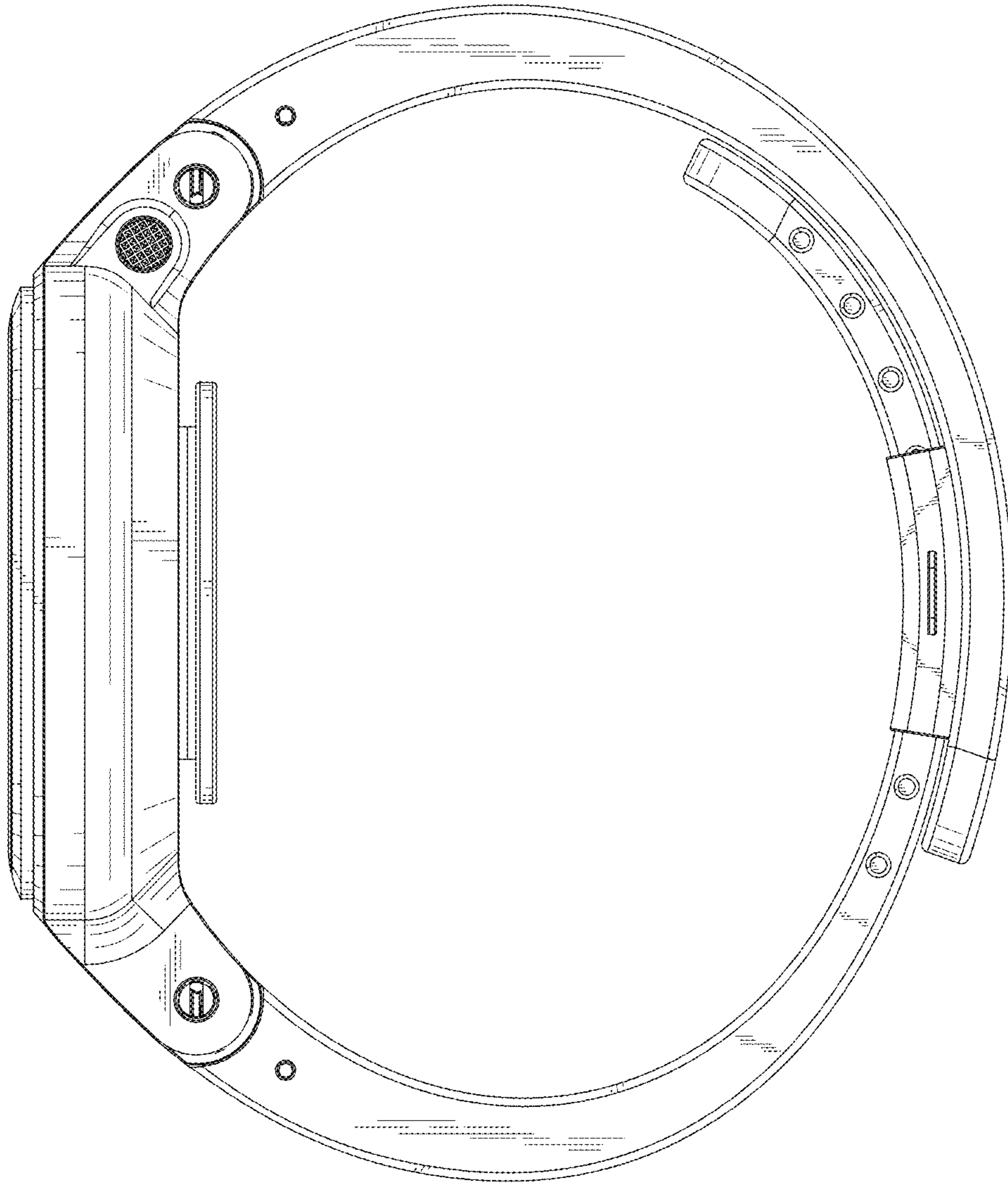

Figure 4

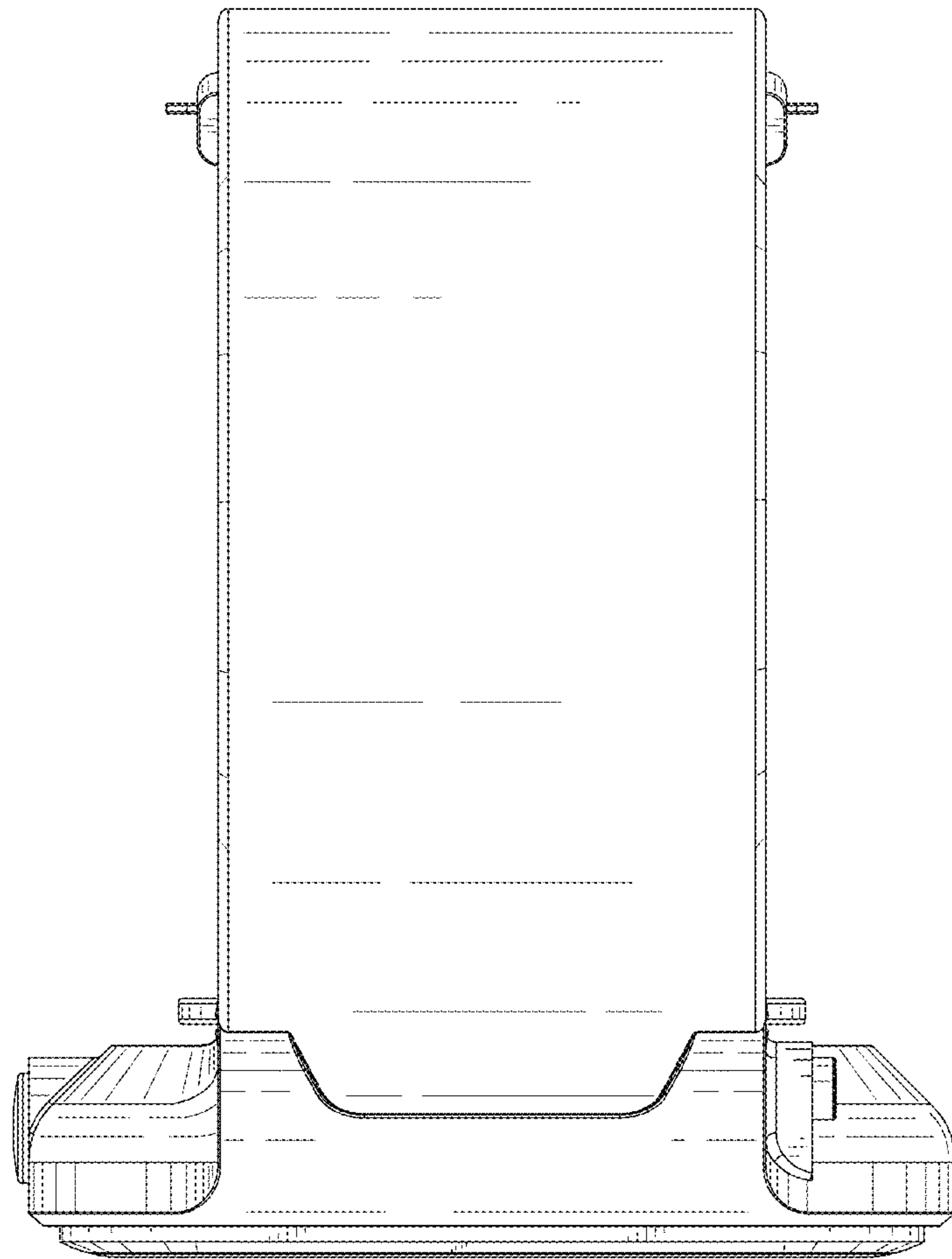

Figure 5

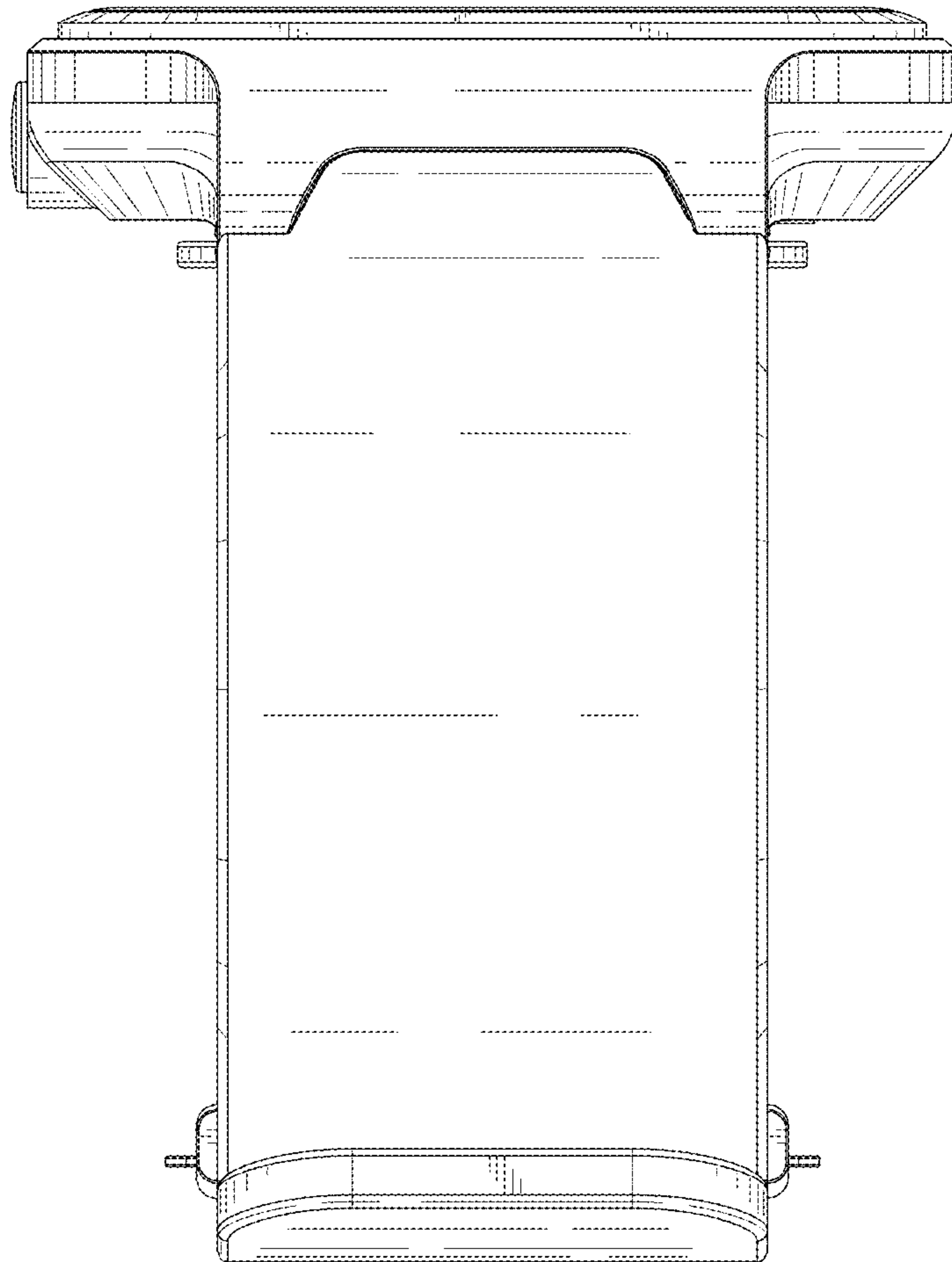

Figure 6

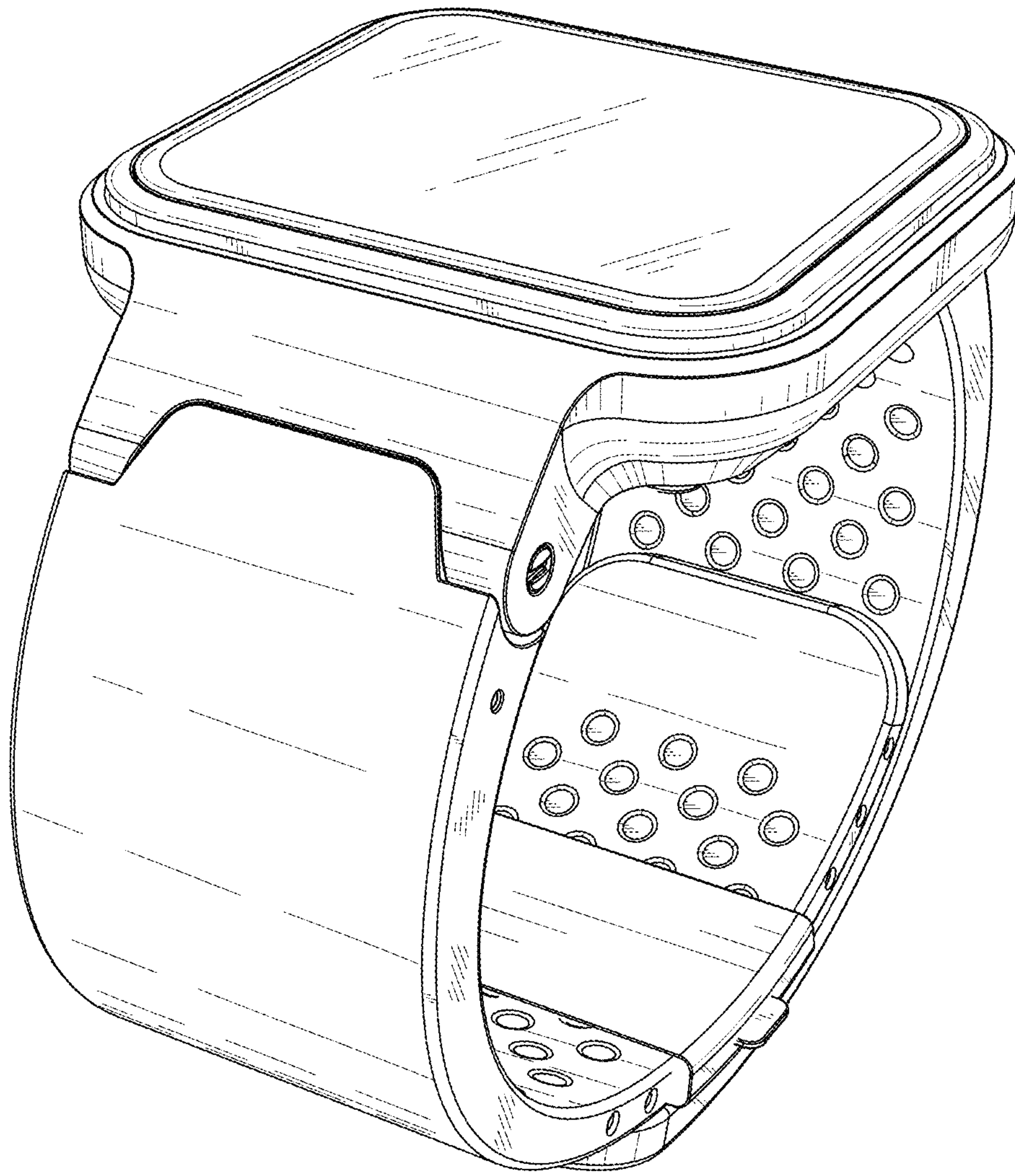

Figure 7