



US00D765010S

(12) **United States Design Patent** (10) **Patent No.:** **US D765,010 S**
De Camargo et al. (45) **Date of Patent:** **** Aug. 30, 2016**

(54) **AIRCRAFT WITH APPLIED SURFACE PATTERN**

(71) Applicant: **EMBRAER S.A.**, São José dos Campos—SP (BR)
(72) Inventors: **Oliver Turci De Camargo**, São José dos Campos SP (BR); **Erich Shibata Nishiyama**, São José dos Campos SP (BR); **Valéria Lie Alonso**, São José dos Campos SP (BR); **Jay Beaver**, Melbourne, FL (US)
(73) Assignee: **EMBRAER S.A.**, São José dos Campos—SP (BR)

(**) Term: **15 Years**
(21) Appl. No.: **29/538,354**
(22) Filed: **Sep. 2, 2015**

Related U.S. Application Data

(62) Division of application No. 29/470,394, filed on Oct. 21, 2013.
(51) **LOC (10) Cl.** **12-07**
(52) **U.S. Cl.**
USPC **D12/342**
(58) **Field of Classification Search**
USPC D12/16.1, 319–345; D21/447, 448, D21/450, 453
CPC B64C 1/00; B64C 1/068; B64C 1/26; B64C 2001/0045; B64C 2001/0054; B64C 3/00; B64C 3/10; B64C 5/02; B64C 5/06; B64D 27/00; B64D 27/02; B64D 27/16; B64D 27/18; B64D 27/20; B64D 29/02; B64D 29/04; Y02T 50/12; Y02T 50/44
See application file for complete search history.

(56) **References Cited**

U.S. PATENT DOCUMENTS

D172,880 S	8/1954	Johnson et al.	
D173,032 S	9/1954	Johnson et al.	
D177,327 S	4/1956	Holtby et al.	
D359,472 S	6/1995	Day	
D386,143 S	11/1997	Astaire	
D505,204 S	5/2005	Eatkins et al.	
D624,479 S	9/2010	Guering	
D624,480 S	9/2010	Guering	
D644,165 S	8/2011	Fujino et al.	
D674,734 S	1/2013	Fujino et al.	
D731,949 S *	6/2015	Matsuo	D12/319
D749,488 S *	2/2016	De Camargo	D12/319
D749,489 S *	2/2016	Da Silva	D12/319
2009/0159751 A1	6/2009	Wittmer et al.	

* cited by examiner

Primary Examiner — Robert M Spear
Assistant Examiner — Marissa J Cash
(74) *Attorney, Agent, or Firm* — Nixon & Vanderhye P.C.

(57) **CLAIM**

The ornamental design for “aircraft with applied surface pattern,” as shown and described.

DESCRIPTION

FIG. 1 is front elevational view of an aircraft with applied surface pattern showing our new design;
FIG. 2 is rear elevational view thereof;
FIG. 3 is a top plan view thereof;
FIG. 4 is a bottom plan view thereof;
FIG. 5 is a left side elevational view thereof;
FIG. 6 is a right side elevational view thereof;
FIG. 7 is left side perspective view thereof; and,
FIG. 8 is right side perspective view thereof.
The structural features depicted by broken lines in the drawings have been shown for the purpose of illustrating portions of the aircraft with applied surface pattern that form no part of the claimed design.

1 Claim, 7 Drawing Sheets

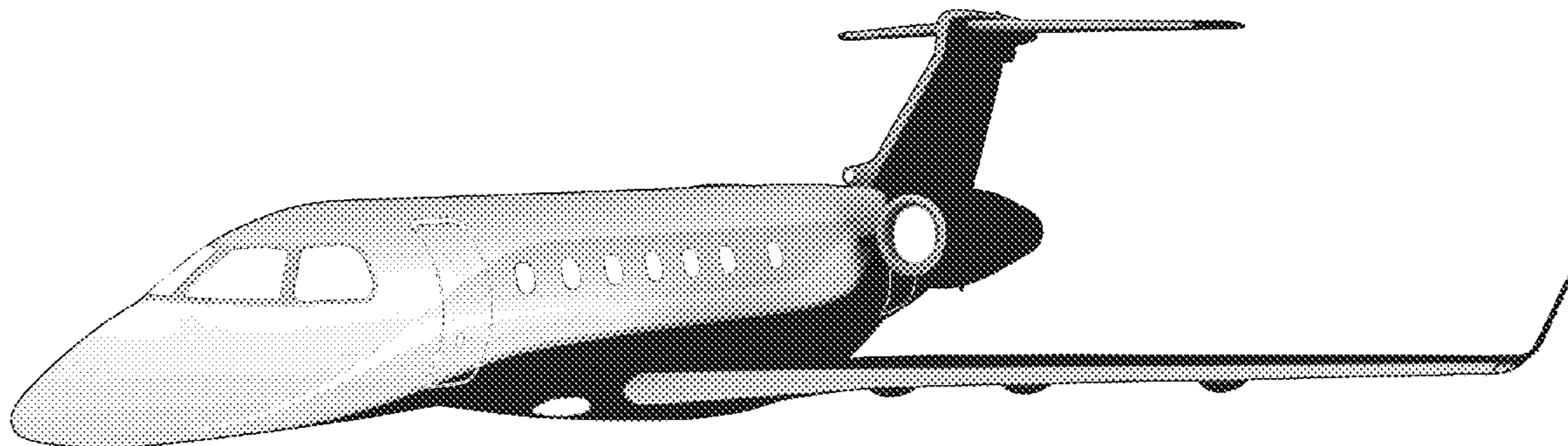

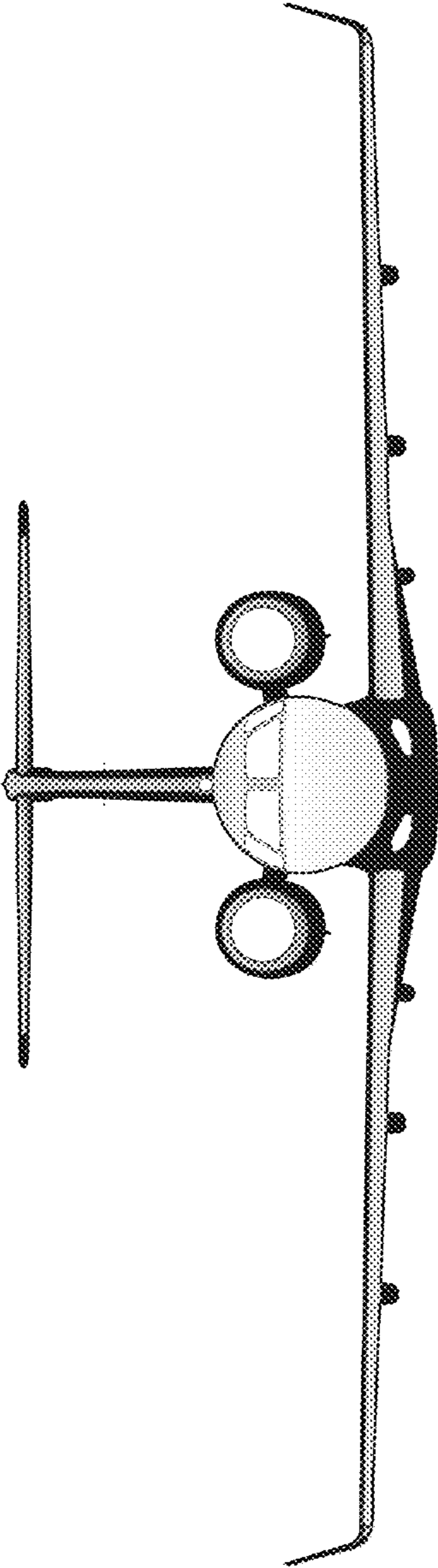

FIG. 1

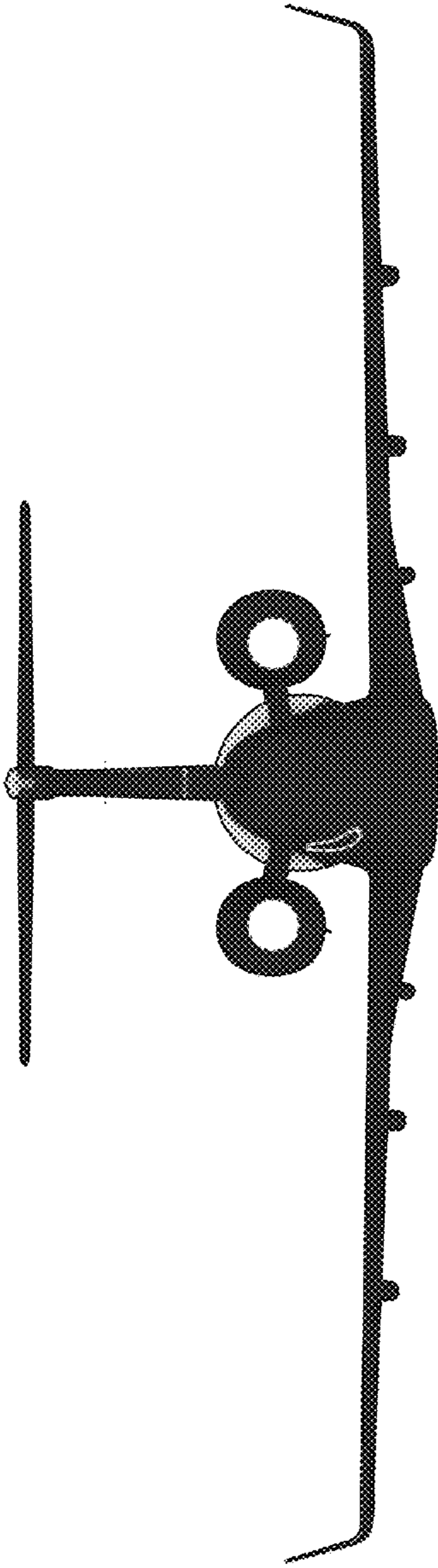

FIG. 2

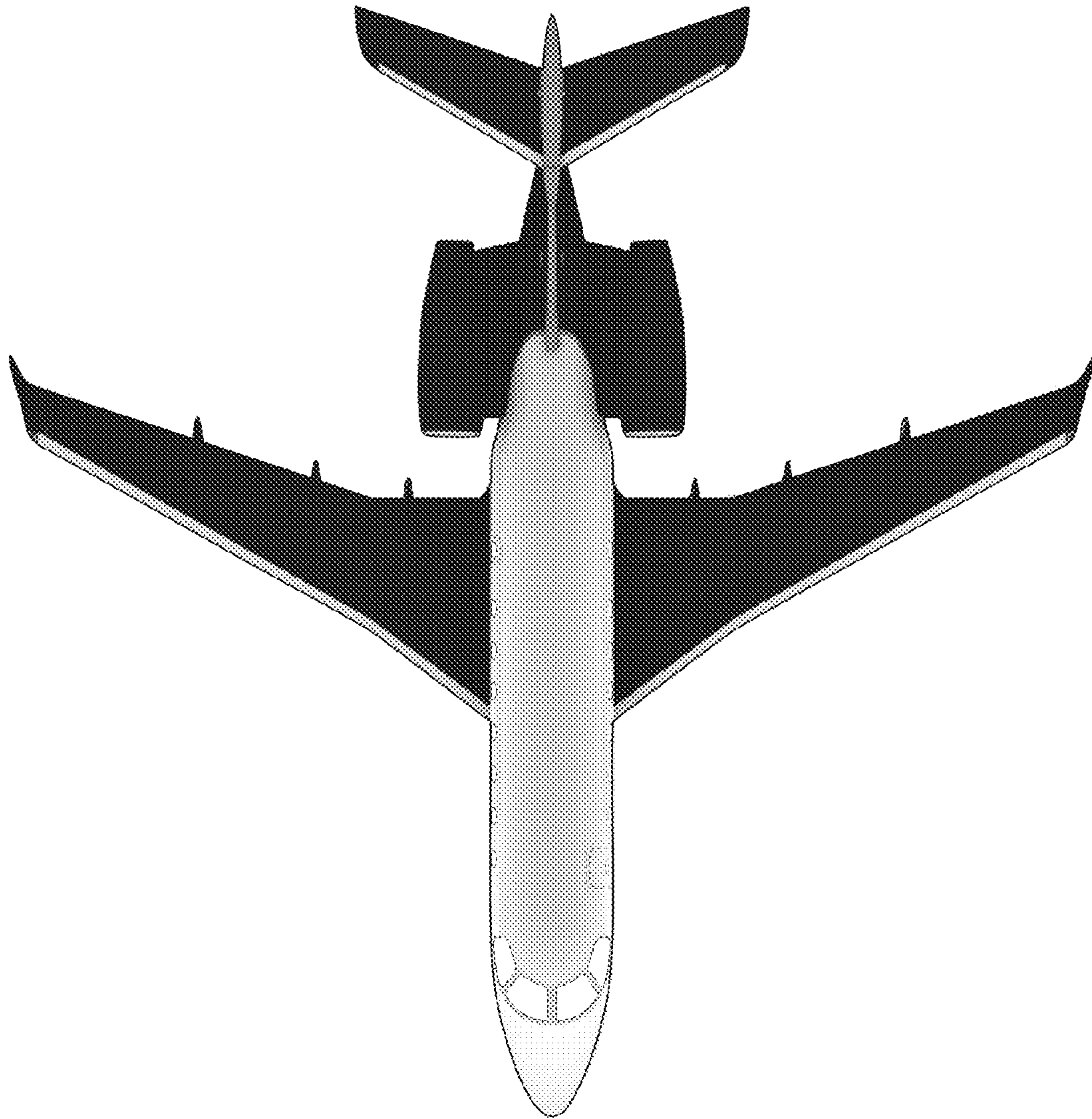

FIG. 3

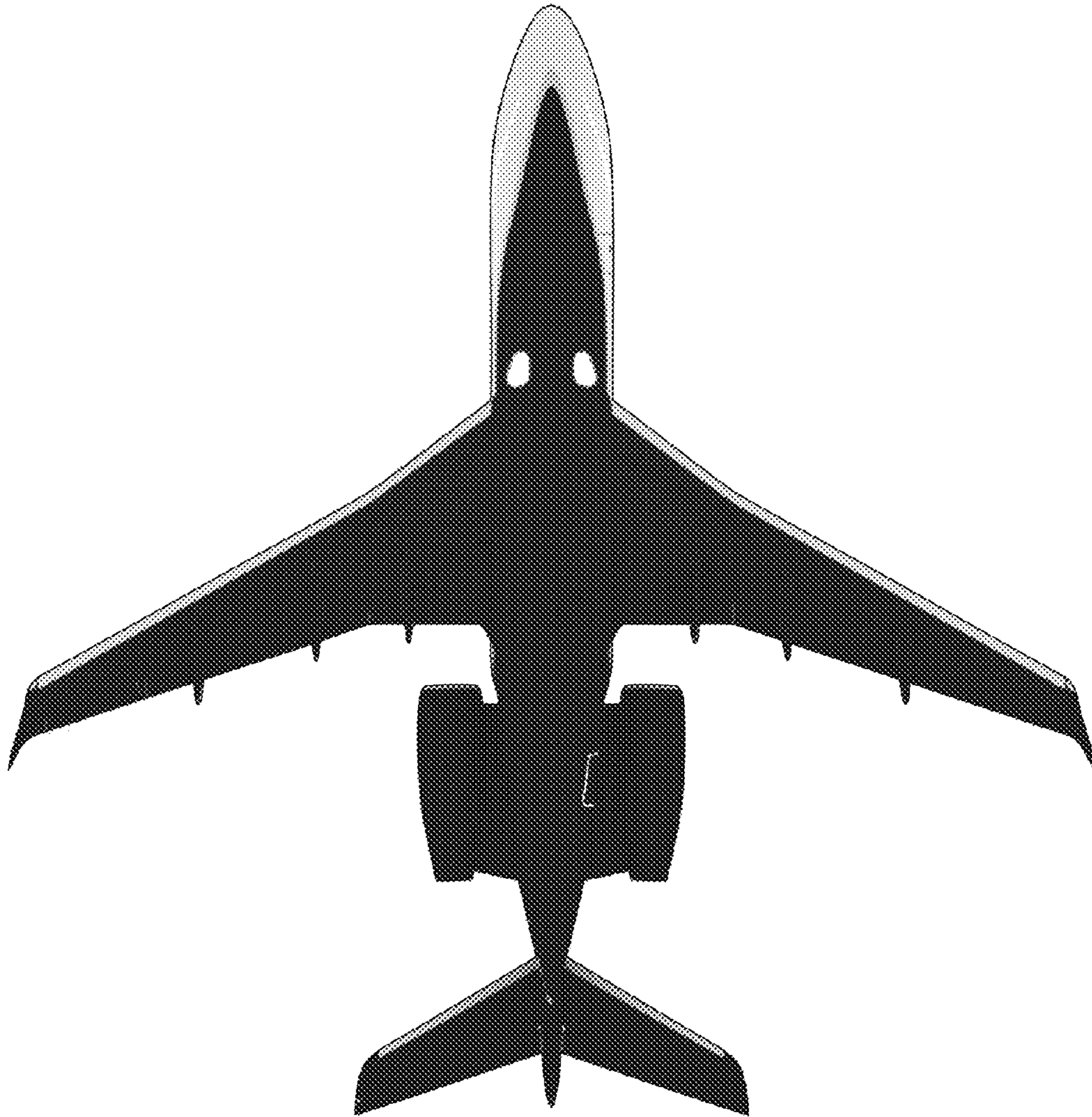

FIG. 4

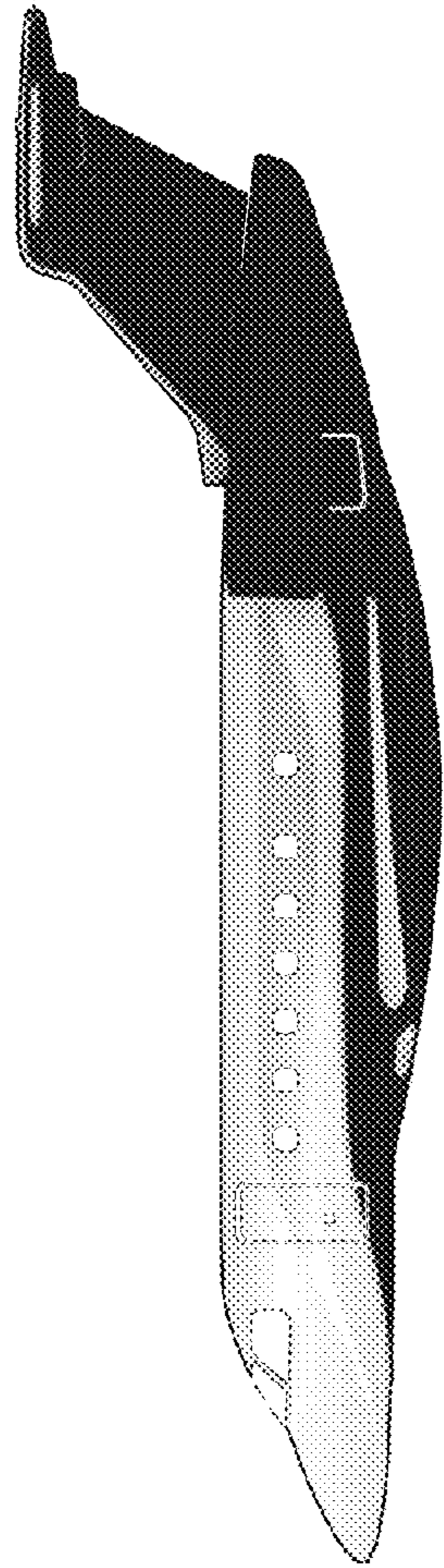

FIG. 5

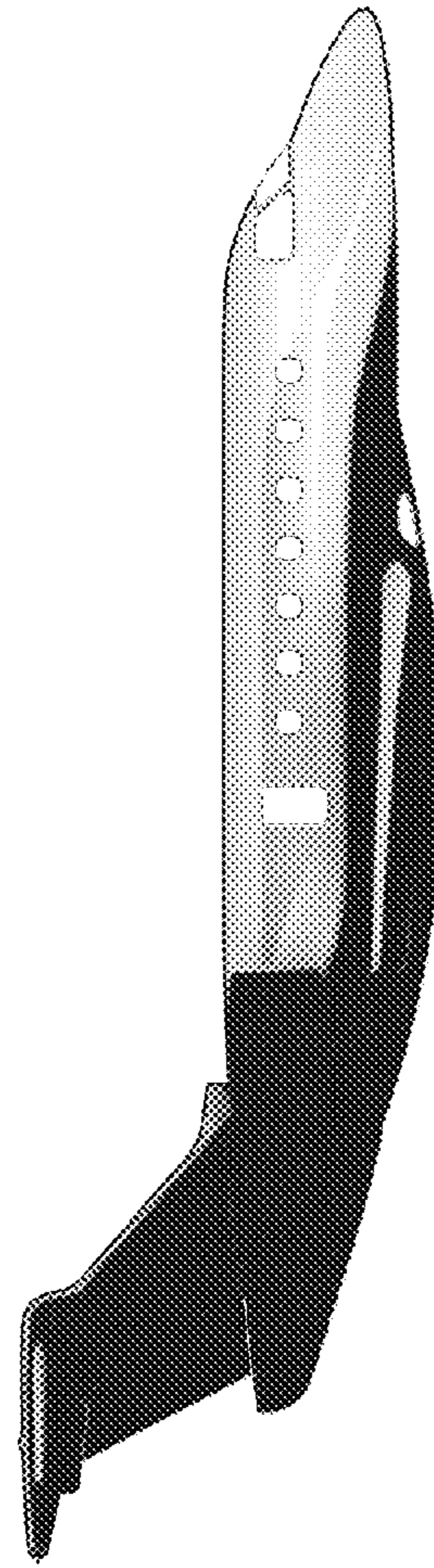

FIG. 6

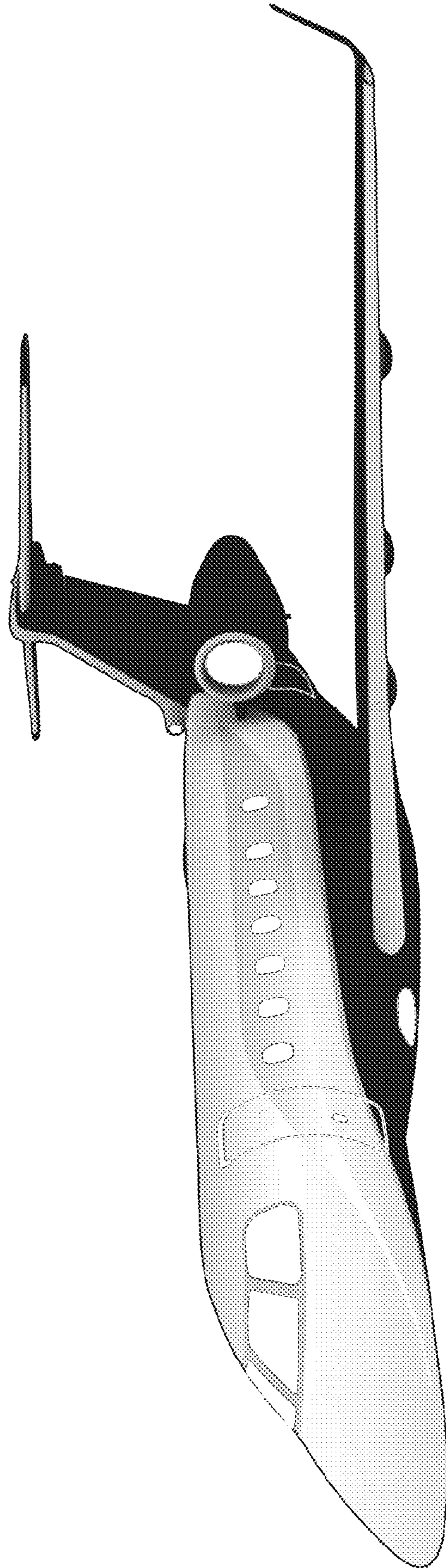

FIG. 7

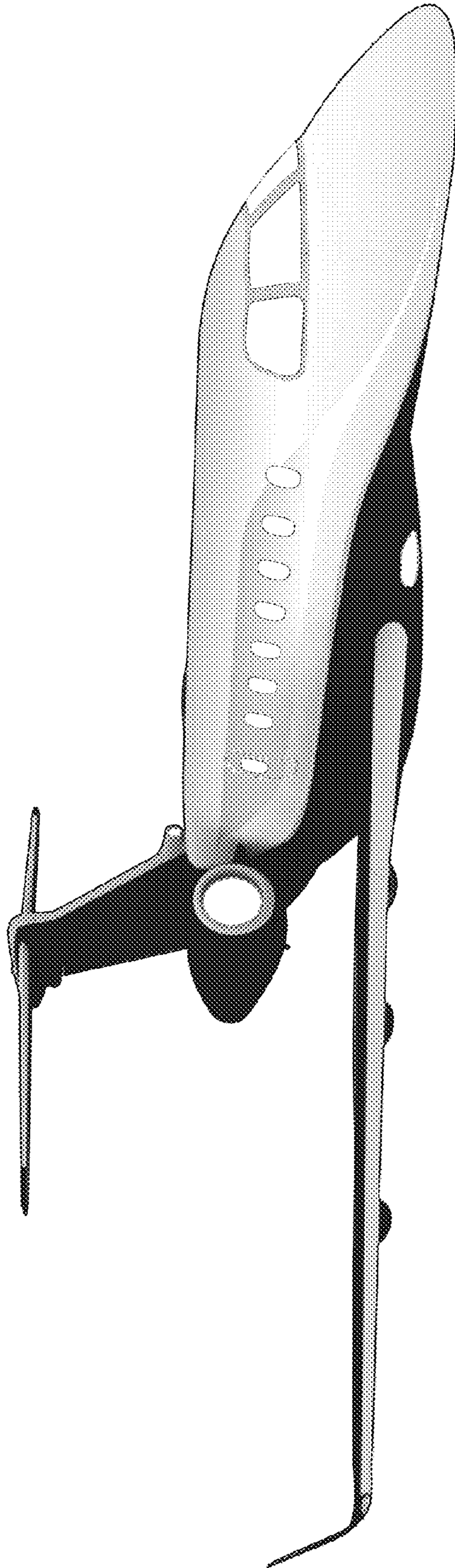

FIG. 8