



US00D764978S

(12) **United States Design Patent** (10) **Patent No.:** **US D764,978 S**
Stone et al. (45) **Date of Patent:** **** Aug. 30, 2016**

(54) **AUTOMOBILE EXTERIOR**

(56) **References Cited**

(71) Applicants: **Nicolas Ren Stone**, Royal Oak, MI (US); **Rimon Ghobrial**, Auburn Hills, MI (US); **Khashayar Honarkhah**, Bloomfield Hills, MI (US); **Mark C. Trostle**, Rochester, MI (US)

U.S. PATENT DOCUMENTS

D414,445 S	9/1999	Dehner et al.	
D510,056 S	9/2005	Hall et al.	
D519,060 S	4/2006	Hall et al.	
D644,960 S *	9/2011	Vardis	D12/92
D645,789 S	9/2011	Vardis et al.	
D645,790 S	9/2011	Vardis et al.	
D652,553 S	1/2012	Vardis et al.	
D680,907 S	4/2013	Vardis et al.	
D684,900 S *	6/2013	Doyle	D12/92
D687,349 S *	8/2013	Kruger	D12/82

(72) Inventors: **Nicolas Ren Stone**, Royal Oak, MI (US); **Rimon Ghobrial**, Auburn Hills, MI (US); **Khashayar Honarkhah**, Bloomfield Hills, MI (US); **Mark C. Trostle**, Rochester, MI (US)

* cited by examiner

Primary Examiner — Melody N Brown

(73) Assignee: **FCA US LLC**, Auburn Hills, MI (US)

(74) *Attorney, Agent, or Firm* — Ralph E Smith

(**) Term: **14 Years**

(57) **CLAIM**

The ornamental design for an automobile exterior, as shown and described.

(21) Appl. No.: **29/510,566**

DESCRIPTION

(22) Filed: **Dec. 1, 2014**

FIG. 1 is a front perspective view of an automobile exterior showing our new design;

(51) **LOC (10) Cl.** **12-08**

FIG. 2 is a rear perspective view thereof;

(52) **U.S. Cl.**
USPC **D12/92**

FIG. 3 is a right side view thereof;

(58) **Field of Classification Search**
USPC D12/86, 90–92, 88; D21/421, 433, 434;
296/181.1, 181.5

FIG. 4 is a left side view thereof;

CPC B62D 35/00; B62D 25/00; B62D 25/06;
B62D 33/00

FIG. 5 is a front view thereof;

FIG. 6 is a rear elevation view thereof; and;

FIG. 7 is a top plan view thereof.

It will be understood that the broken lines shown in the drawings illustrate portions of the automobile exterior that form no part of claimed design.

See application file for complete search history.

1 Claim, 5 Drawing Sheets

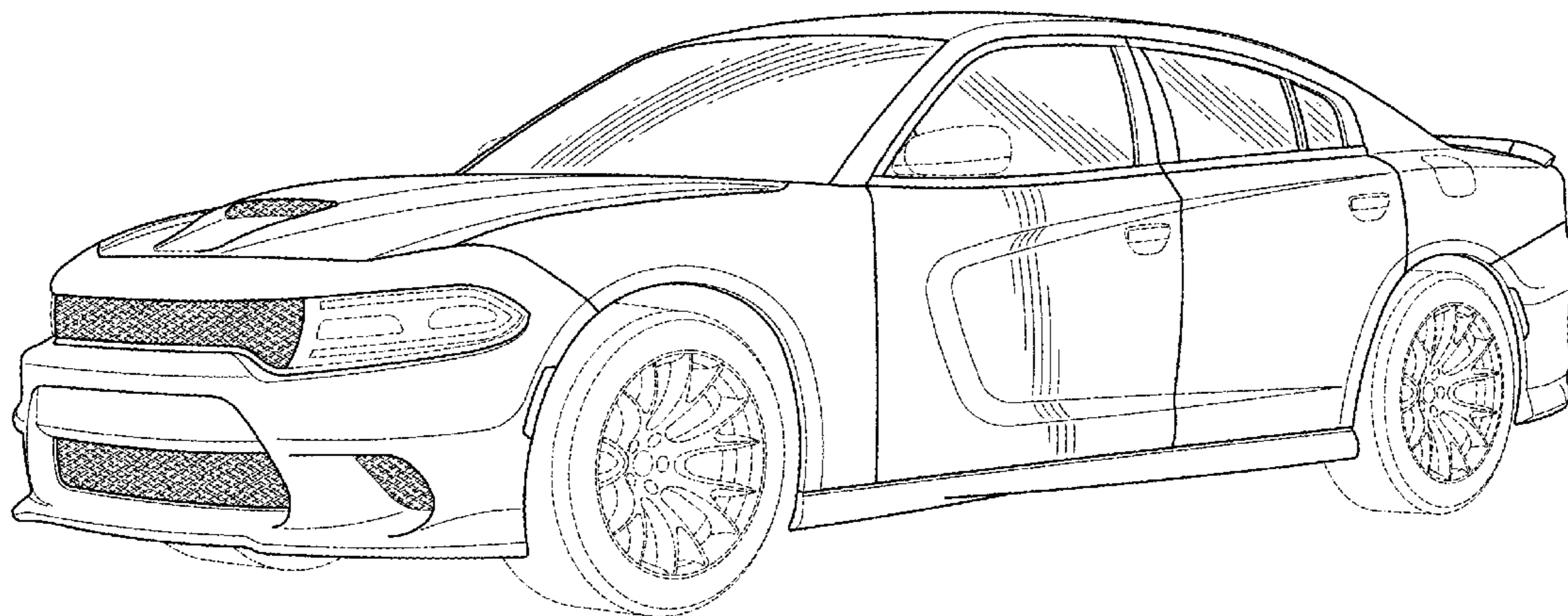

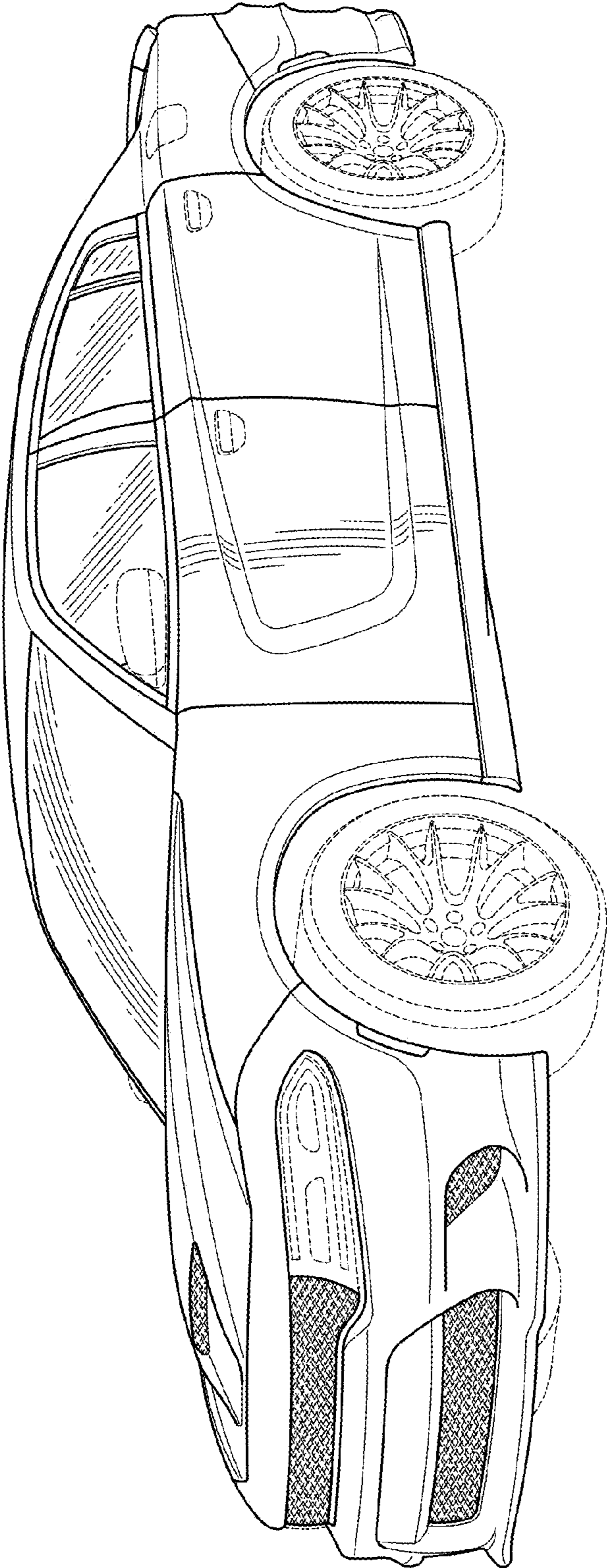

FIG. 1

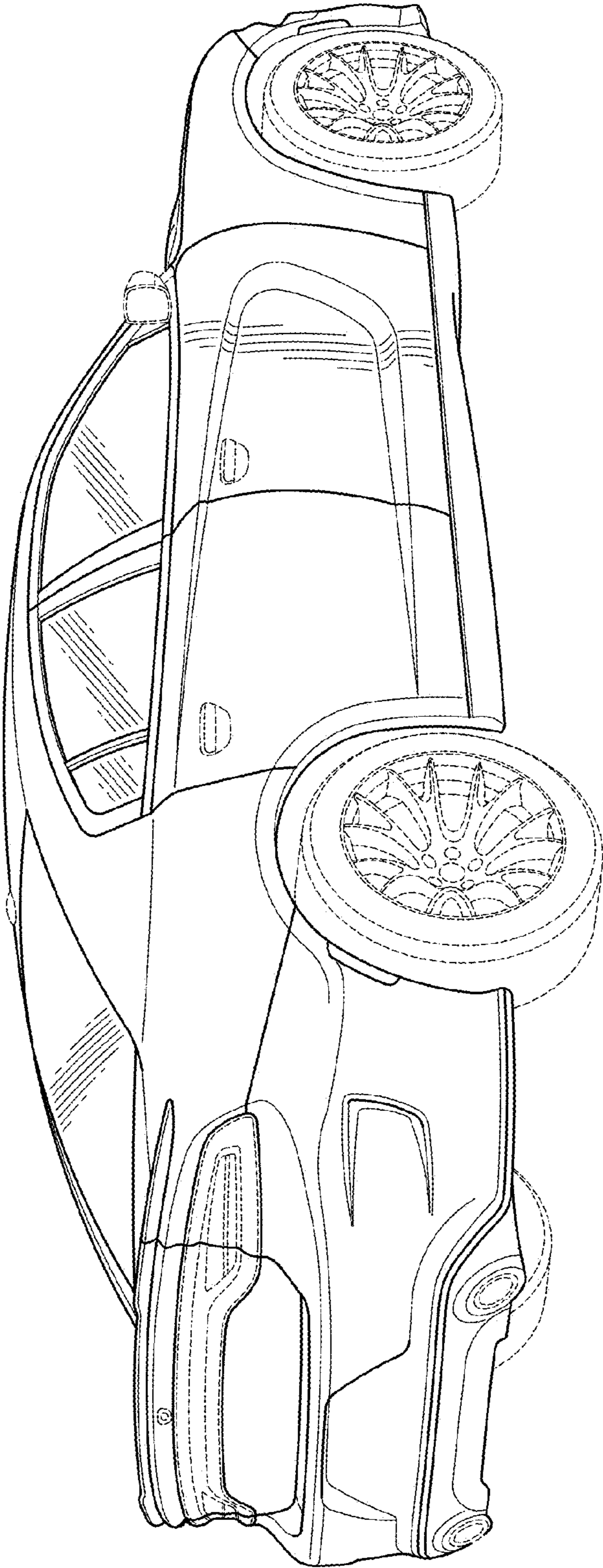

FIG. 2

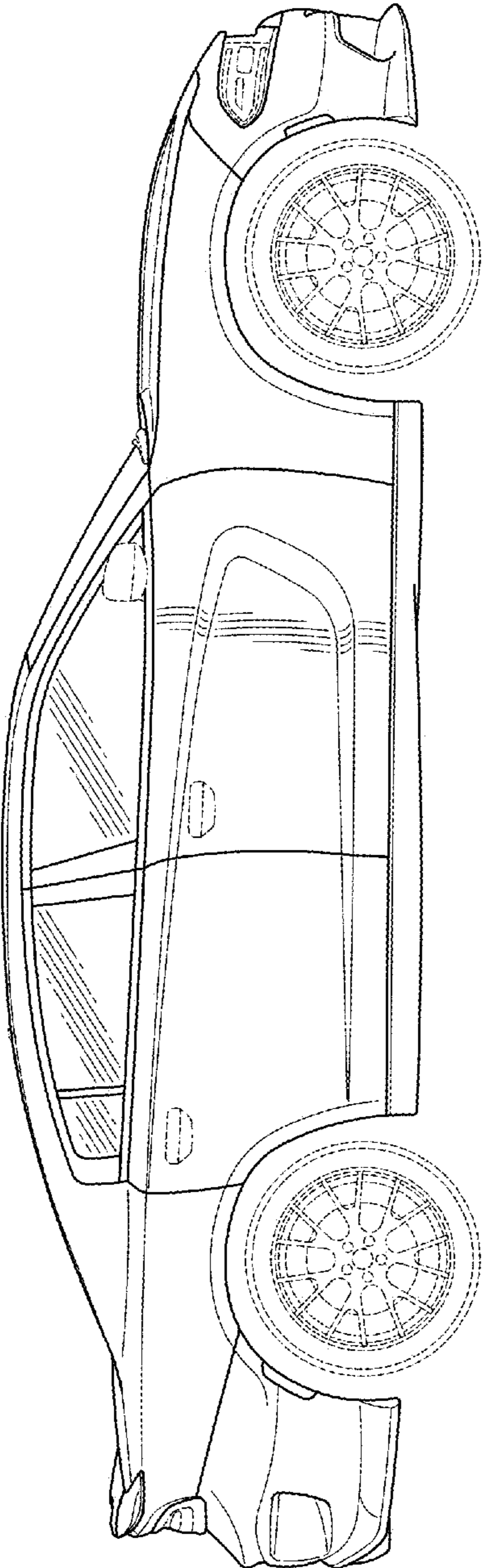

FIG. 3

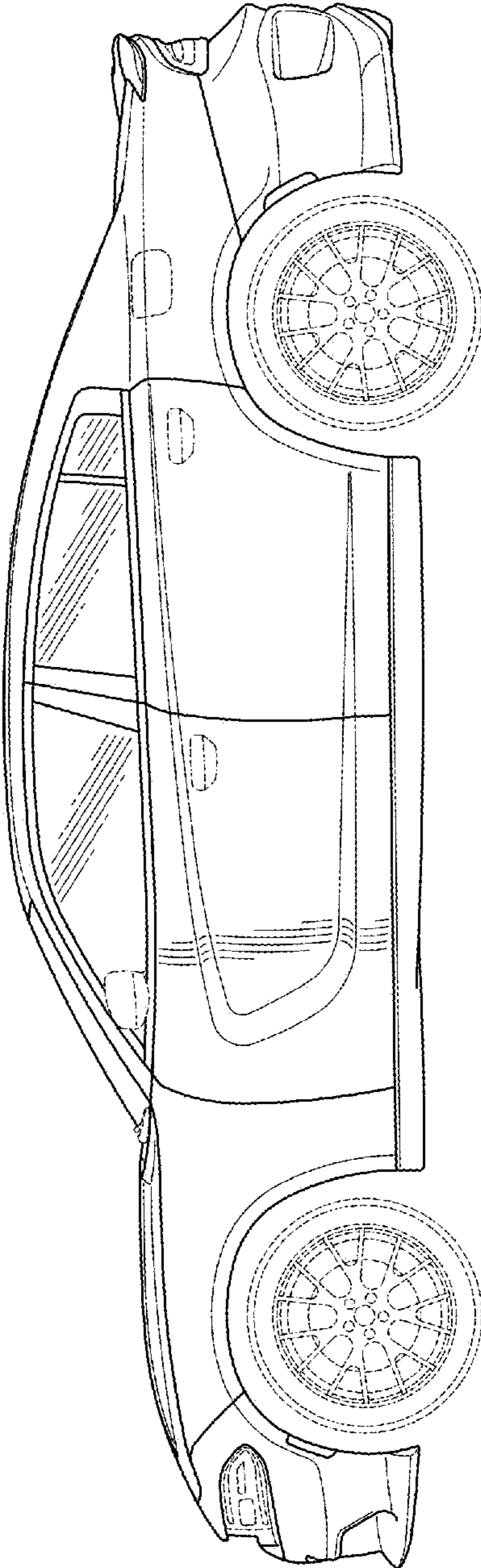

FIG. 4

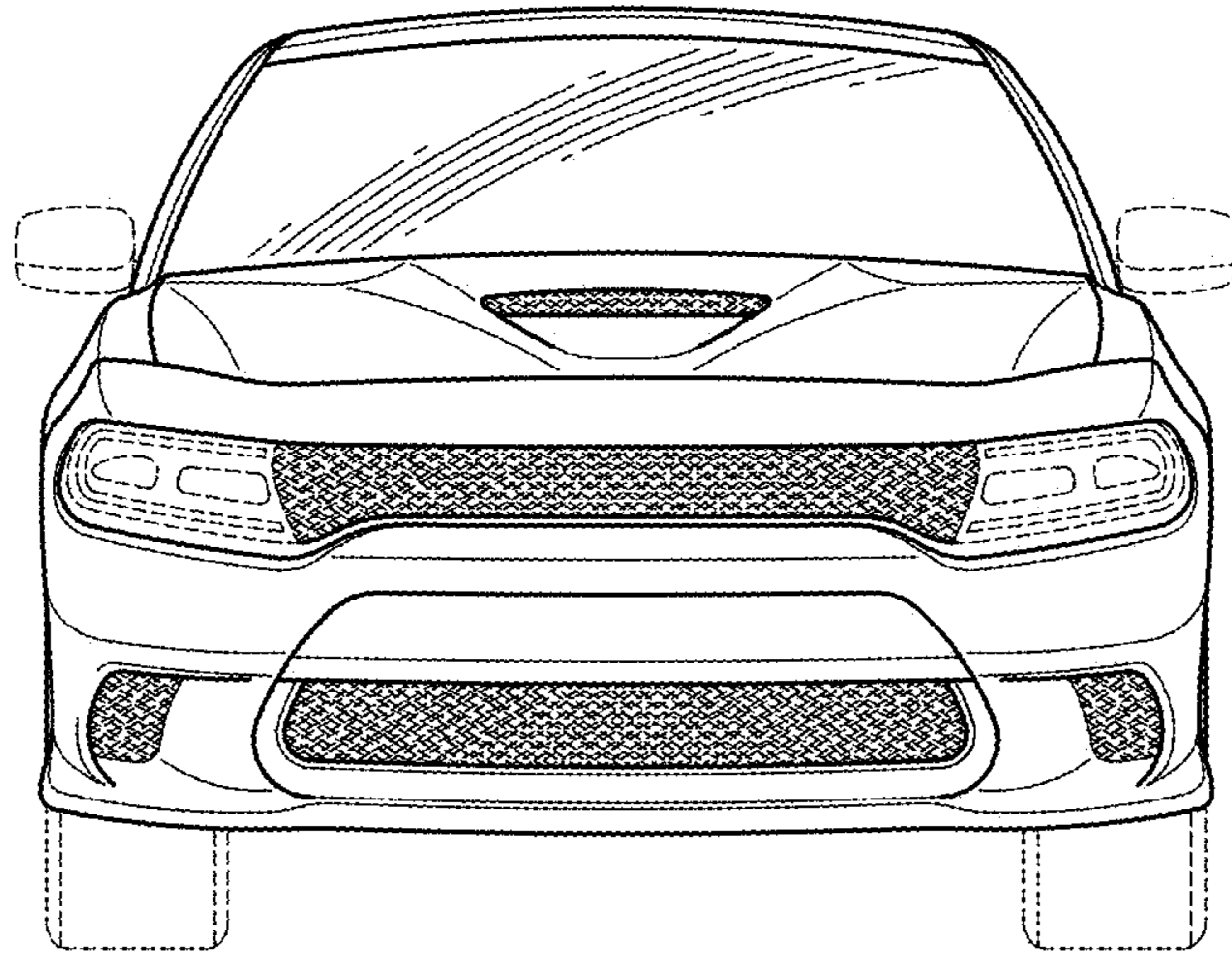

FIG. 5

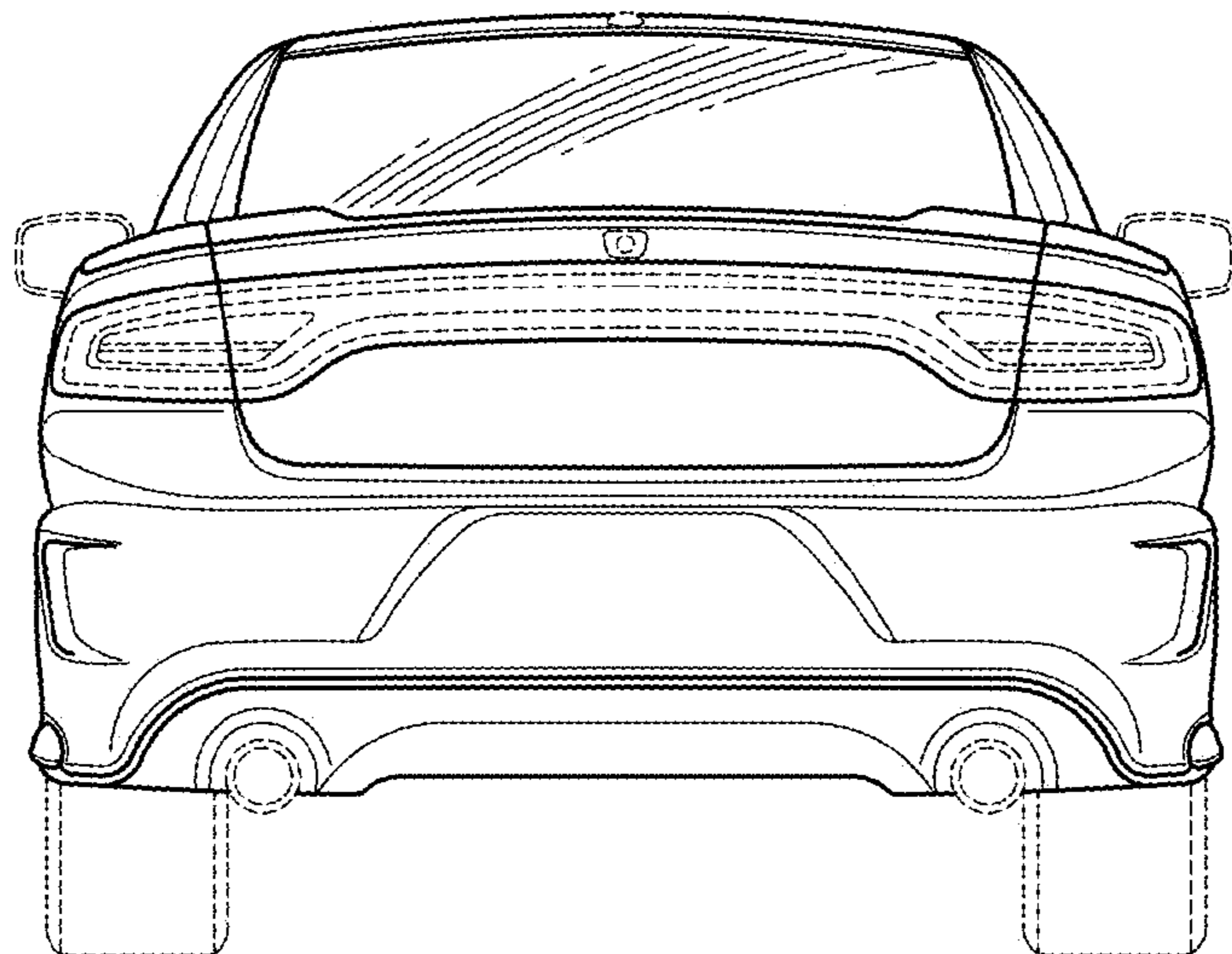

FIG. 6

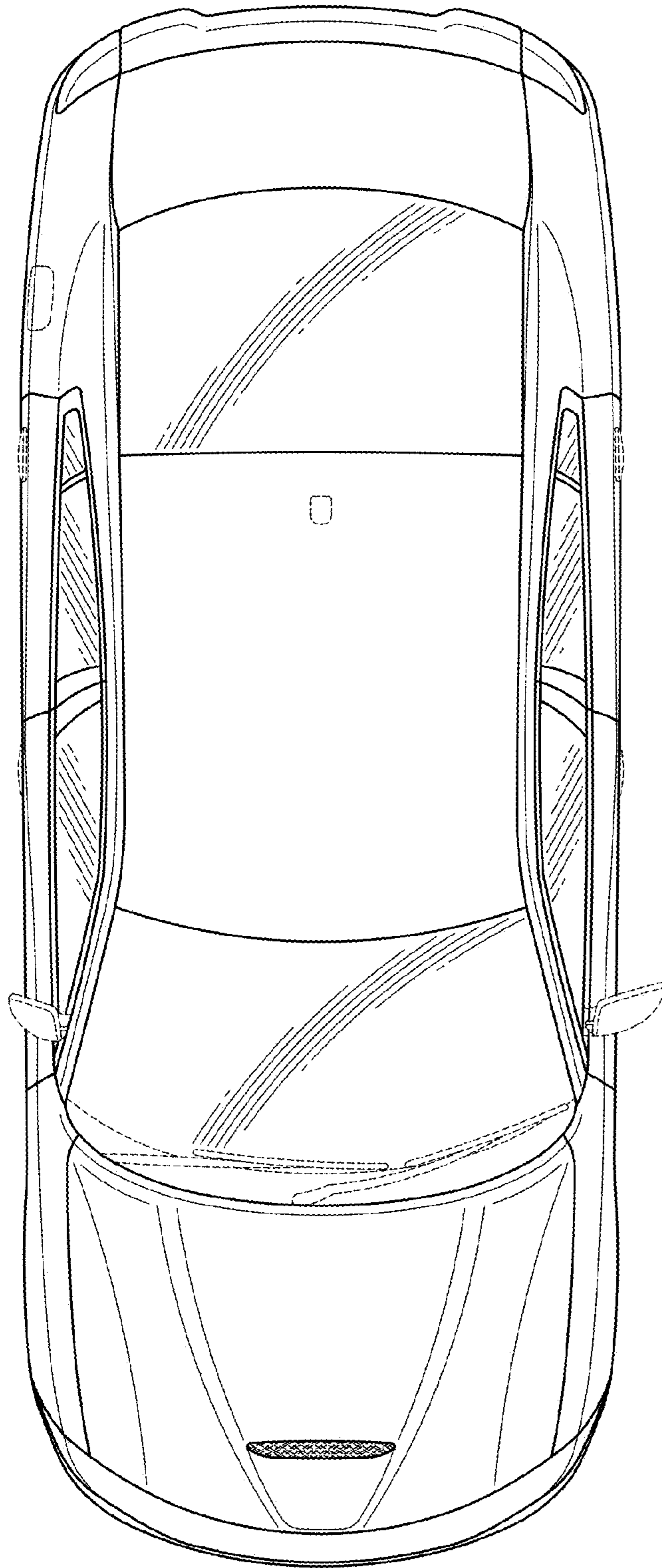

FIG. 7