



US00D764869S

(12) **United States Design Patent** (10) **Patent No.:** **US D764,869 S**
Smrtnik et al. (45) **Date of Patent:** **** Aug. 30, 2016**

- (54) **COFFEE MUG SET**
- (71) Applicant: **ZkotZ d.o.o.**, Ljubljana Dobrunje (SI)
- (72) Inventors: **Klemen Smrtnik**, Vrnik (SI); **Damir Islamovic**, Vrnik (SI); **Dejan Kos**, Vrnik (SI)
- (73) Assignee: **ZkotZ d.o.o.**, Ljubljana, Doburnje (SI)
- (**) Term: **14 Years**
- (21) Appl. No.: **29/515,554**
- (22) Filed: **Jan. 23, 2015**
- (51) **LOC (10) Cl.** **07-01**
- (52) **U.S. Cl.**
USPC **D7/507**; D7/515; D7/510
- (58) **Field of Classification Search**
USPC D7/300.1, 510, 511, 598, 599, 600, 608, D7/515, 312, 306, 300, 316, 317, 318, 505, D7/507, 524, 509, 624.2; 169/71; D9/680, D9/610, 657, 601, 521; D22/112; 102/486; D29/125, 126; 220/713, 715, 592.17, 220/592.24, 720; 215/398
CPC .. A47G 19/22; A47G 21/18; A47G 19/2211; A47G 19/2255; A62C 13/003; A47J 41/02; A47J 41/0083
See application file for complete search history.

- D259,088 S * 5/1981 Signorile D11/144
- D262,253 S * 12/1981 Vennola D7/507
- D263,544 S * 3/1982 Vennola D7/507
- 4,618,066 A * 10/1986 Vail A47J 41/00
206/217
- D358,080 S * 5/1995 Handler D7/507
- 5,501,363 A * 3/1996 Muller A47G 19/2227
181/177
- D402,545 S * 12/1998 Kerdoon D9/521
- 5,967,875 A * 10/1999 Graef A47G 19/2211
181/178
- D456,213 S * 4/2002 Darabi D7/509
- D522,375 S * 6/2006 Archeny D9/521
- D694,066 S * 11/2013 Volkov D7/507
- D723,871 S * 3/2015 Khubani D7/505
- D729,008 S * 5/2015 Rankin D7/507
- D744,783 S * 12/2015 McClellan D7/507

* cited by examiner

Primary Examiner — Marianne Pandozzi
(74) *Attorney, Agent, or Firm* — F. Chau & Associates, LLC

(57) **CLAIM**
The ornamental design for a coffee mug set, as shown and described.

DESCRIPTION

FIG. 1 is a right side elevational view of a coffee mug set showing our new design;
FIG. 2 is a front elevation view thereof;
FIG. 3 is a perspective view thereof;
FIG. 4 is a left side perspective view thereof;
FIG. 5 is another perspective view thereof;
FIG. 6 is an exploded perspective view thereof;
FIG. 7 is a right side perspective view thereof where the sleeve is used as a stand;
FIG. 8 is a top perspective view thereof;
FIG. 9 is a cross-sectional view taken along line 9-9 of FIG. 10; and,
FIG. 10 is a top plan view thereof.

1 Claim, 10 Drawing Sheets

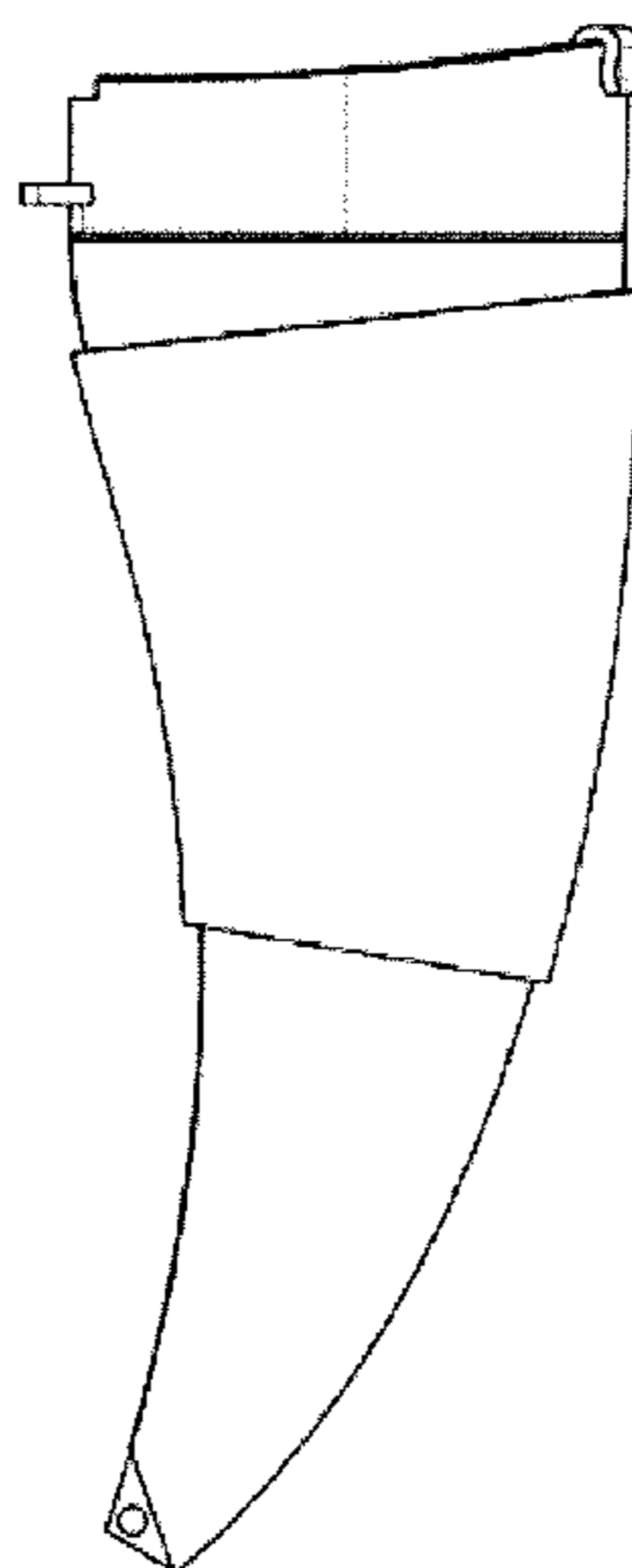

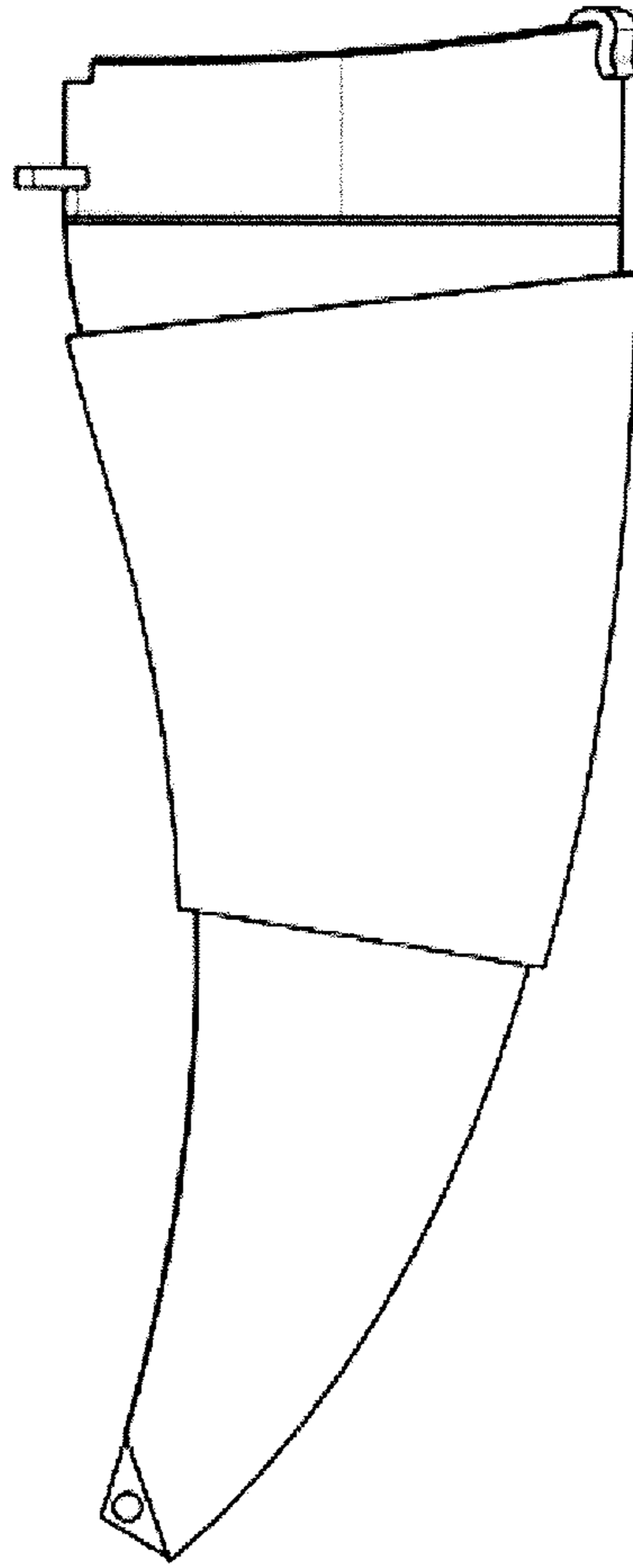

FIG. 1

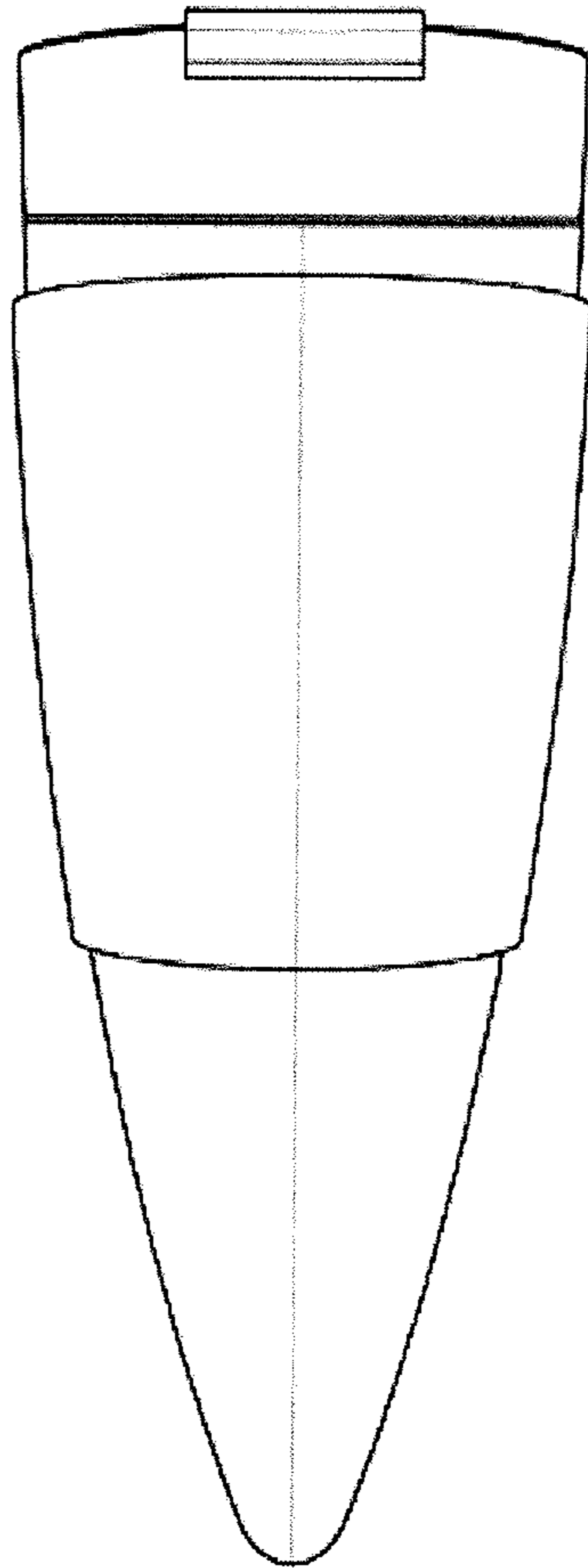

FIG. 2

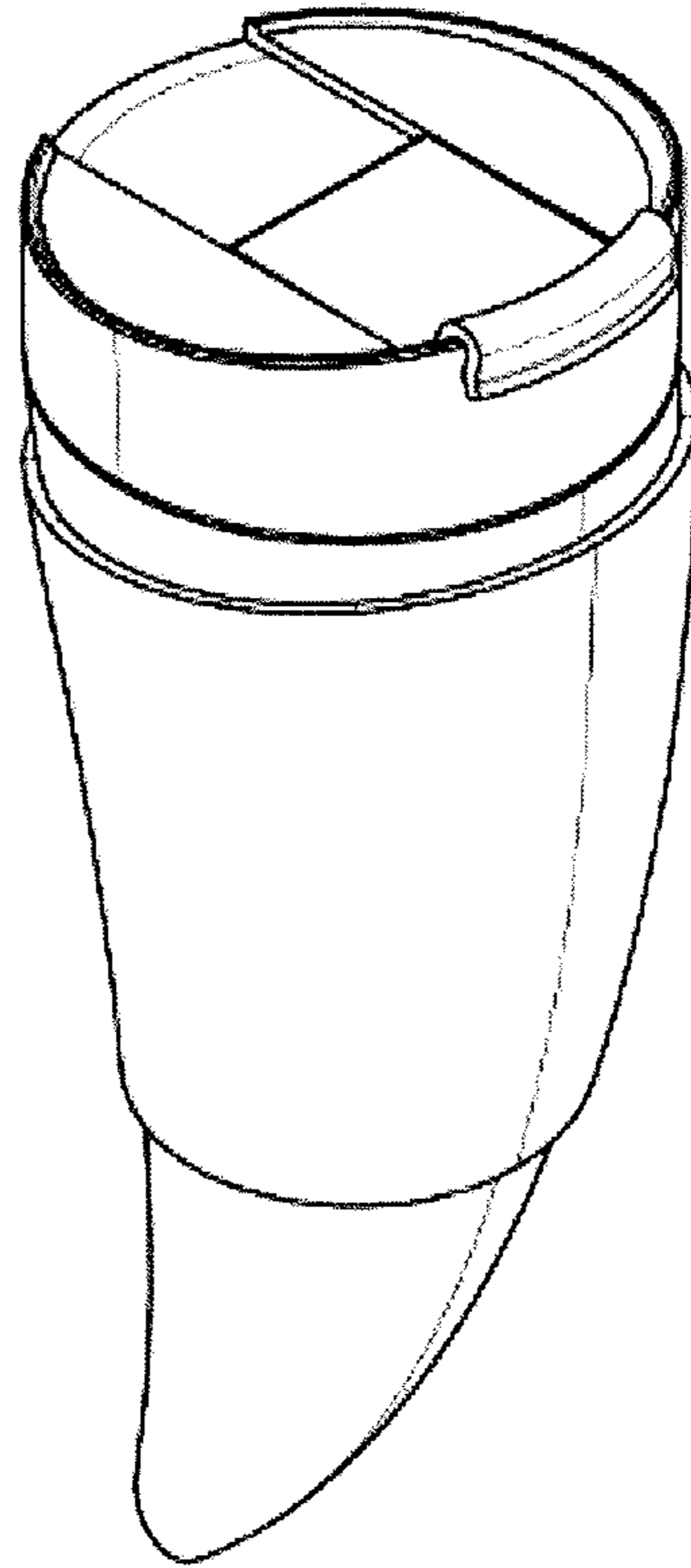

FIG. 3

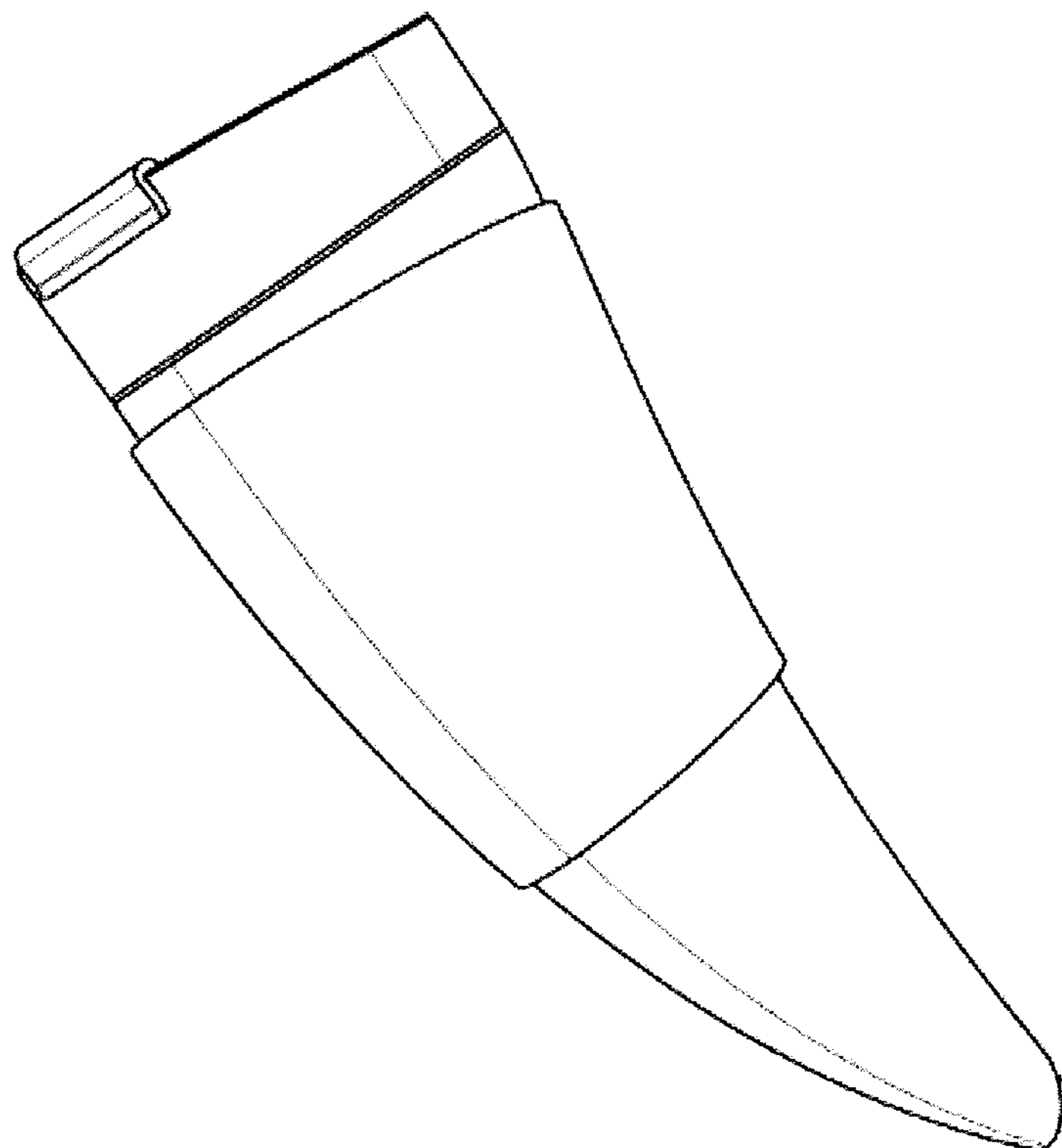

FIG. 4

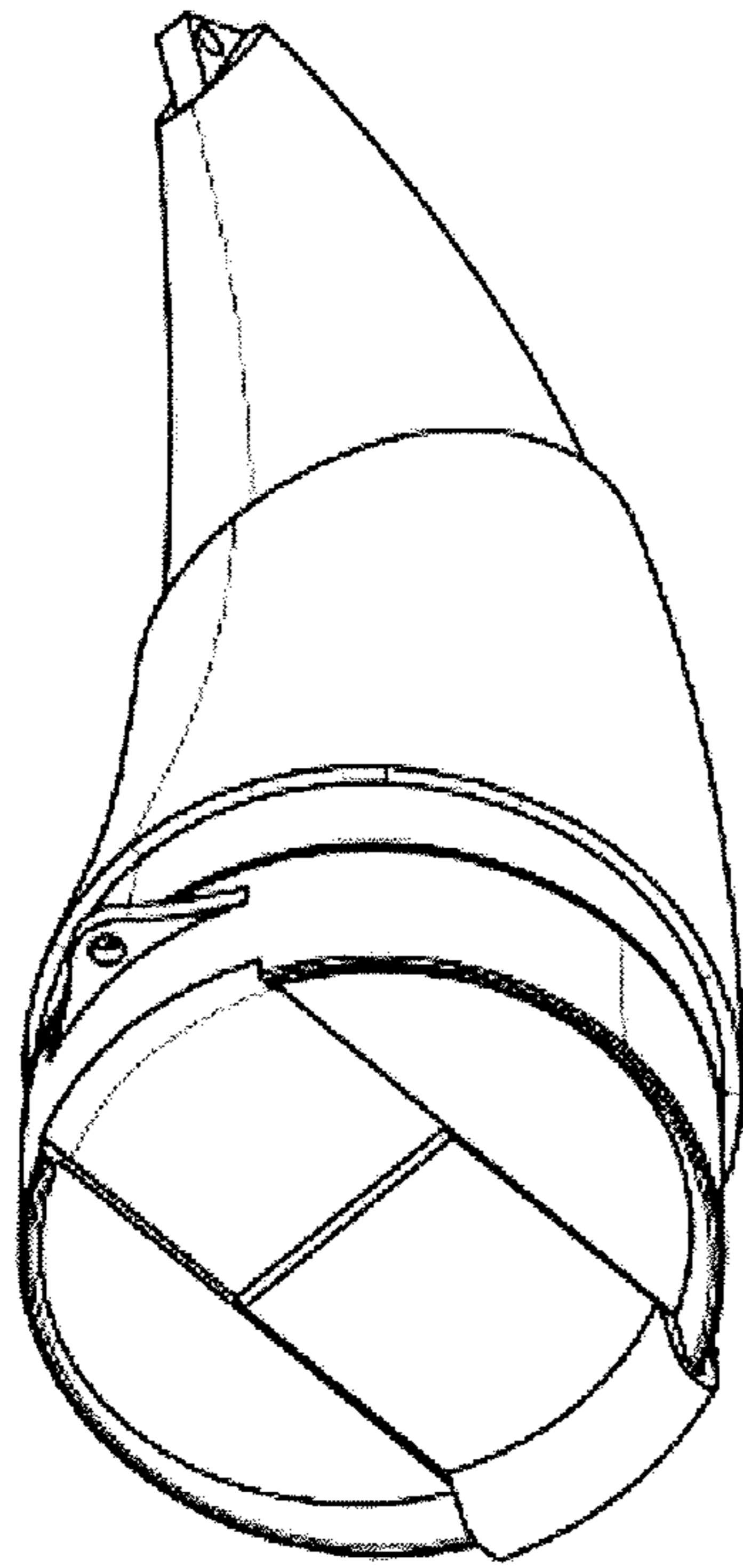

FIG. 5

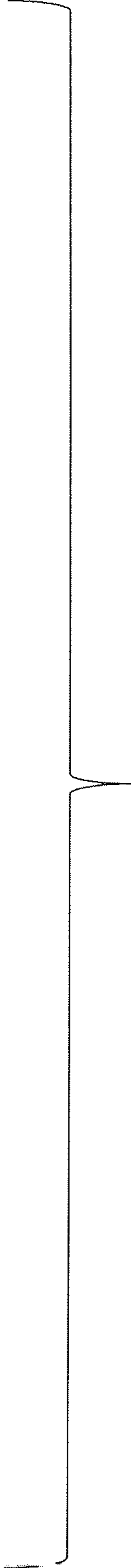
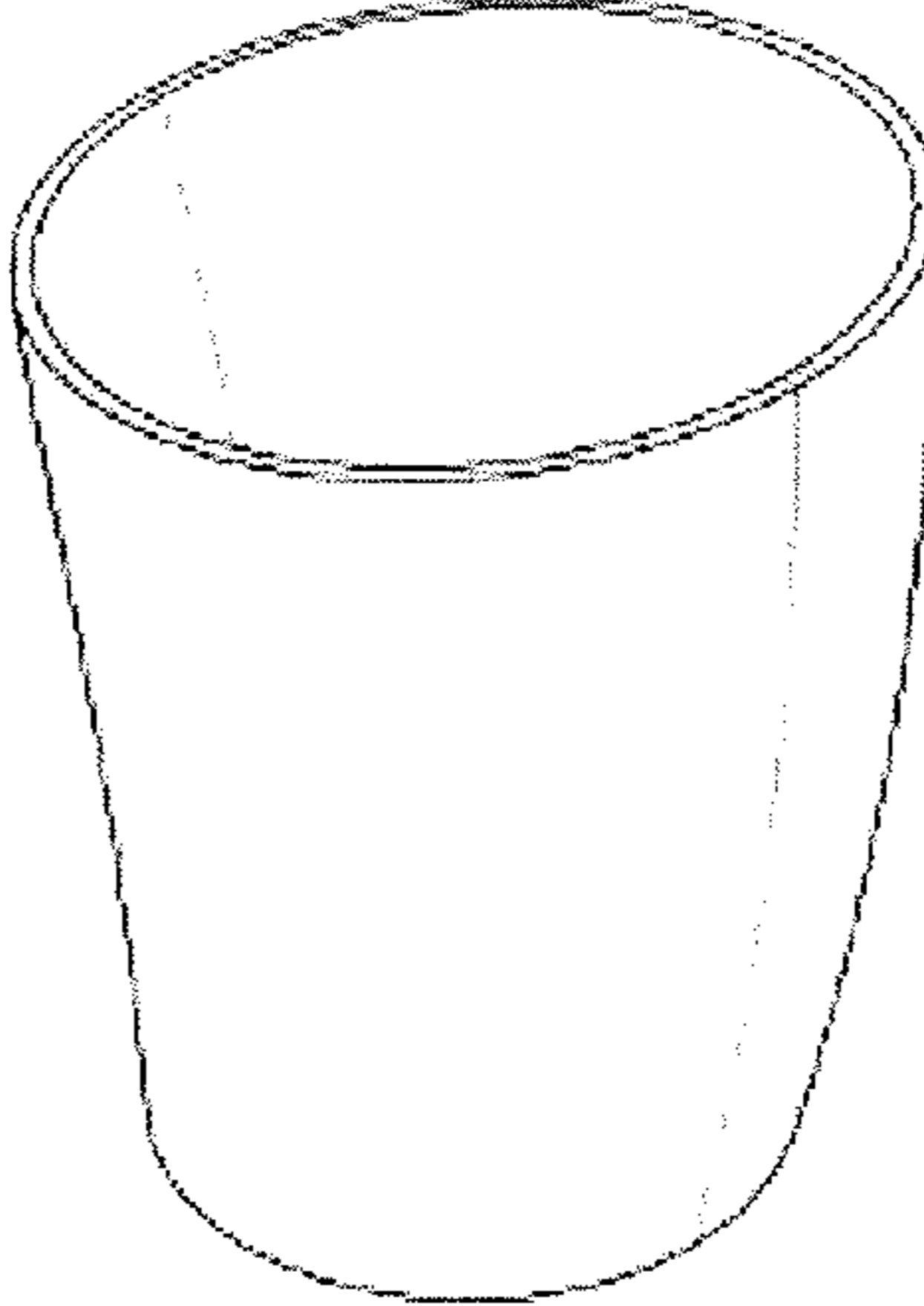
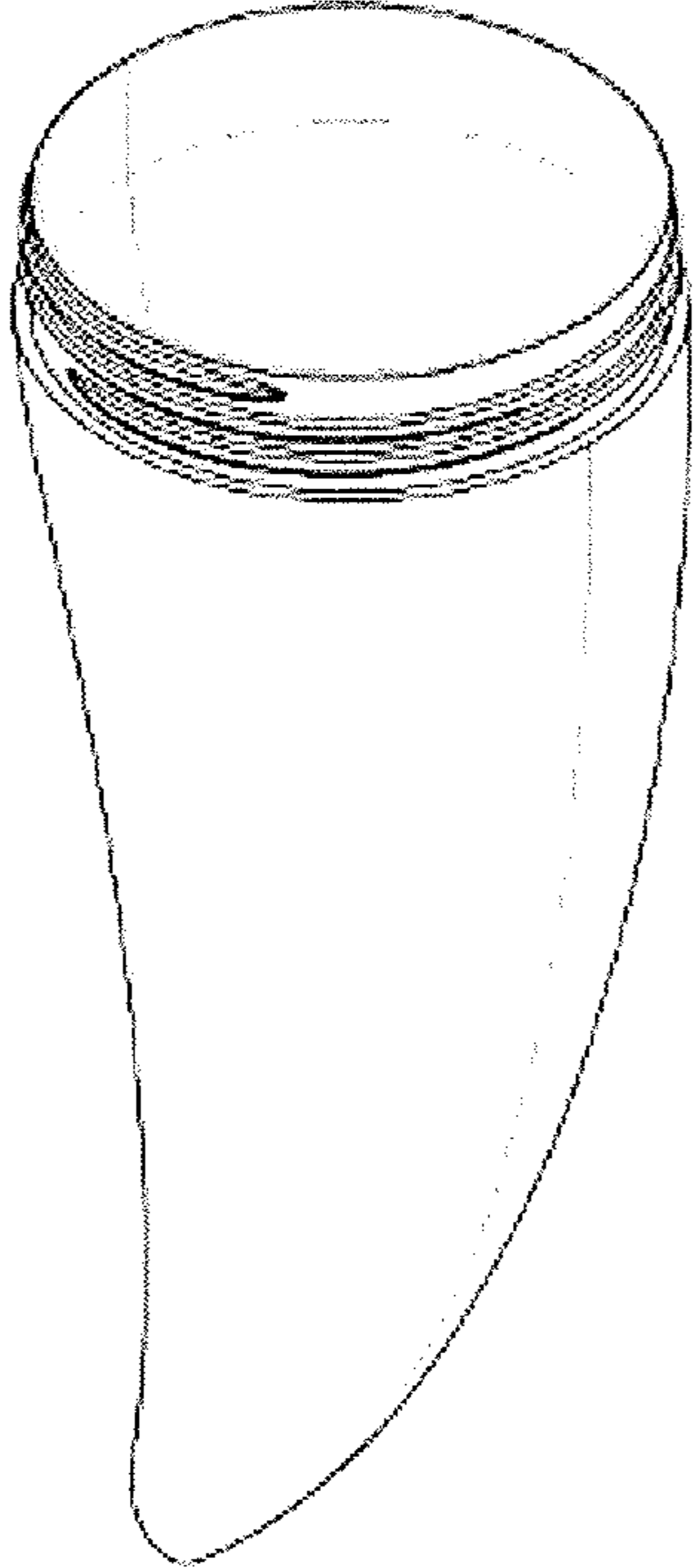
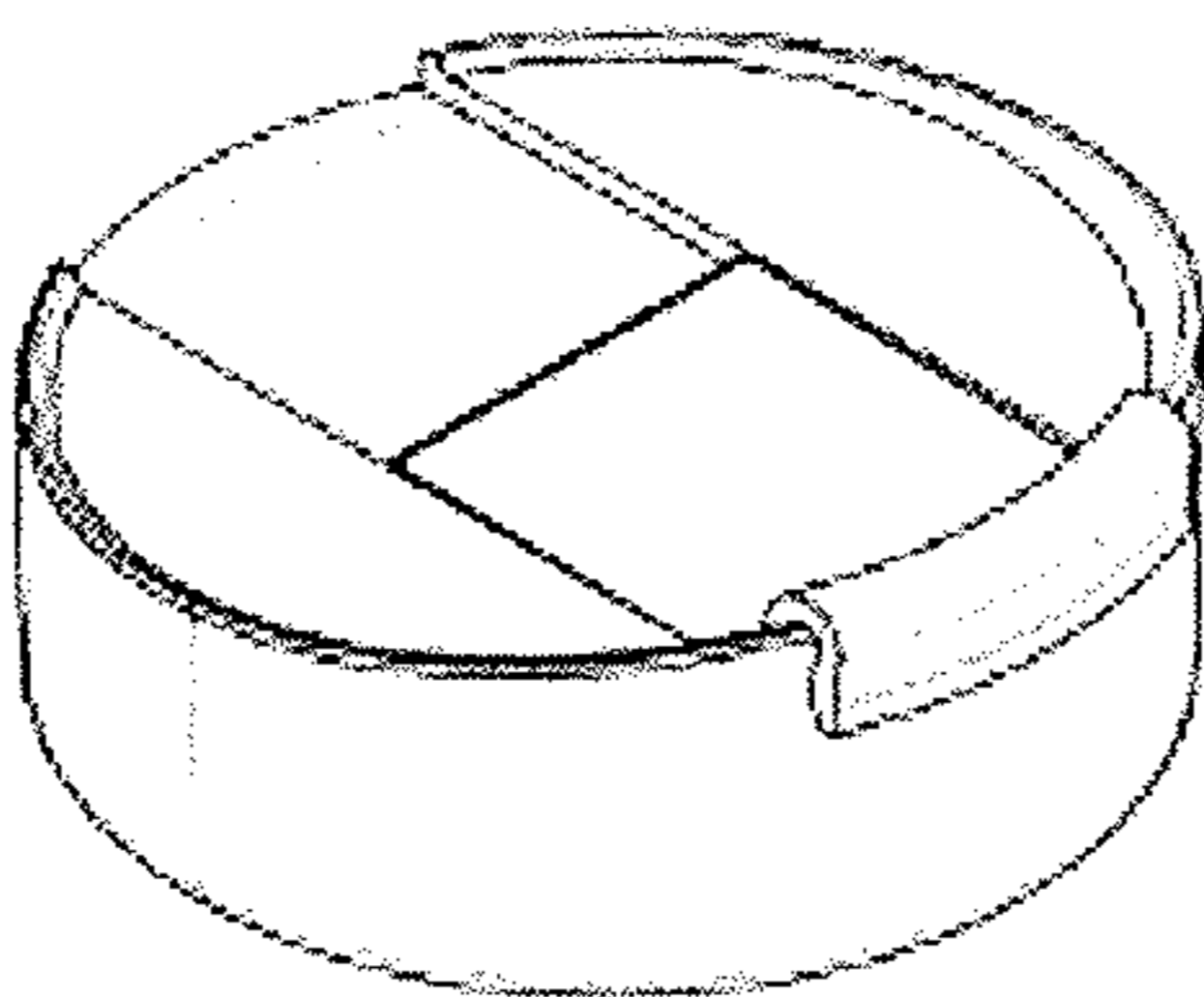

FIG. 6

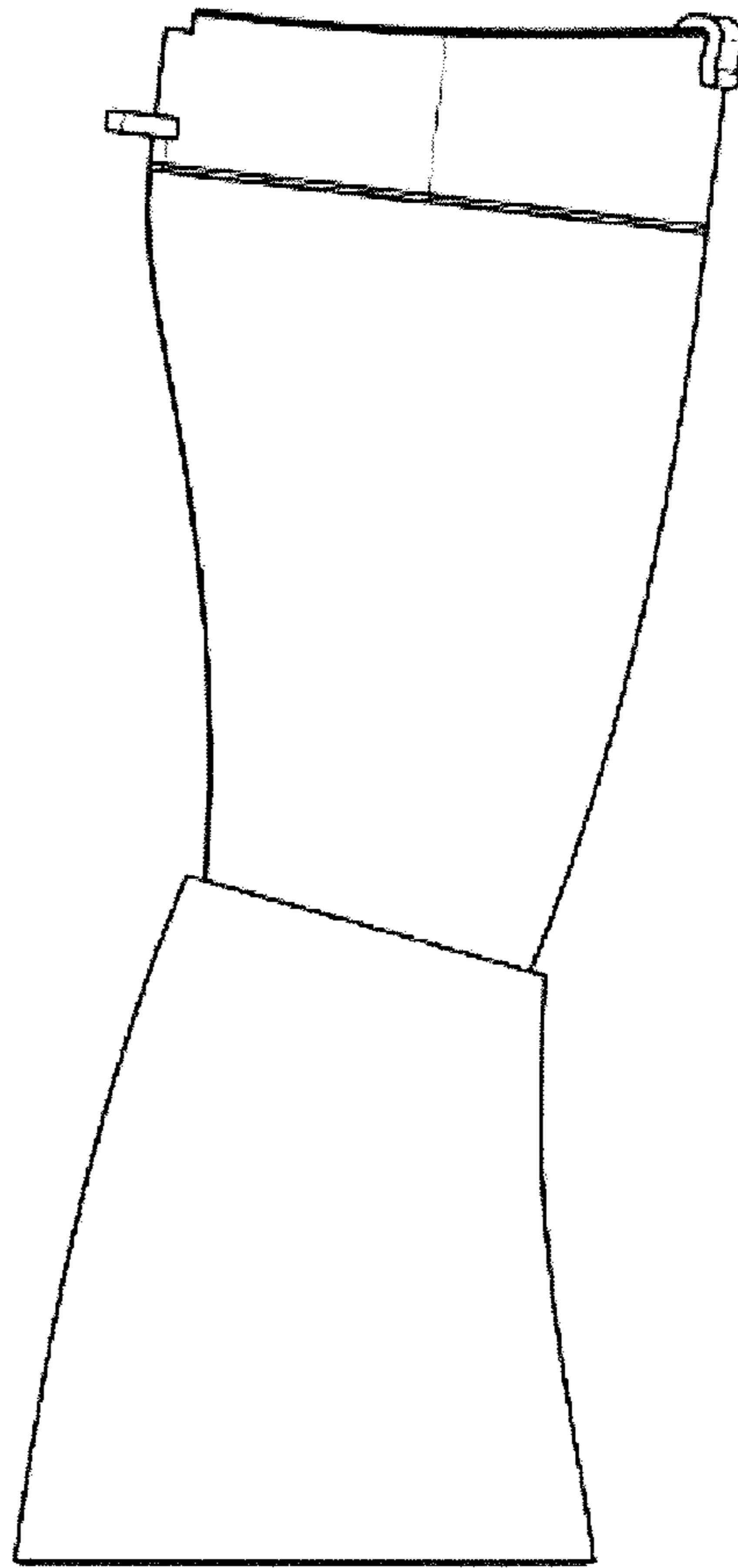

FIG. 7

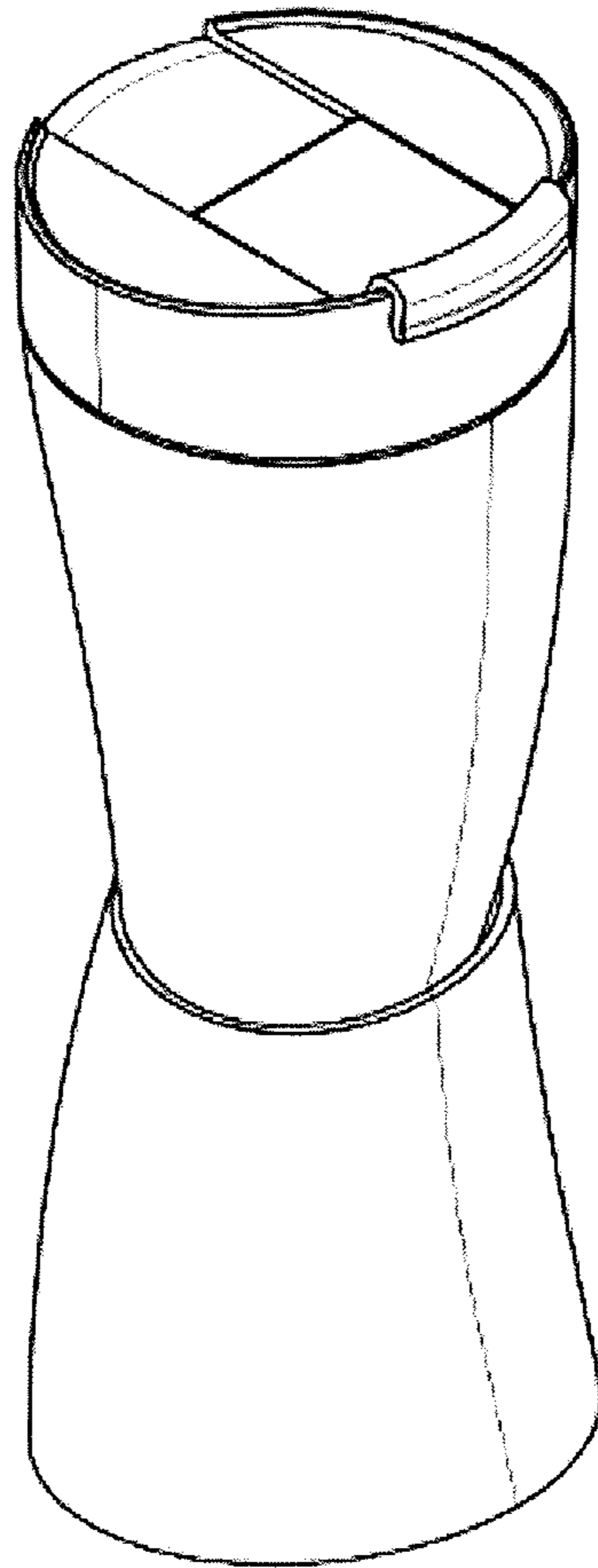

FIG. 8

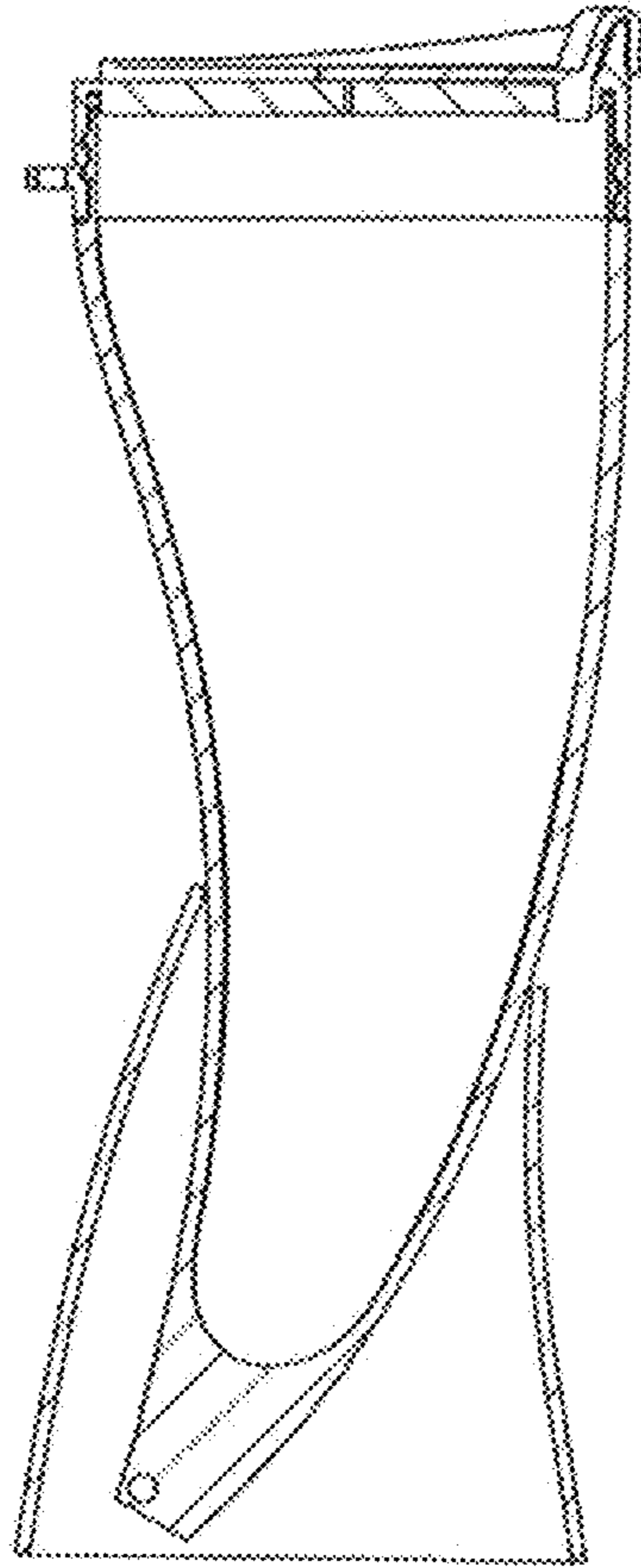

FIG. 9

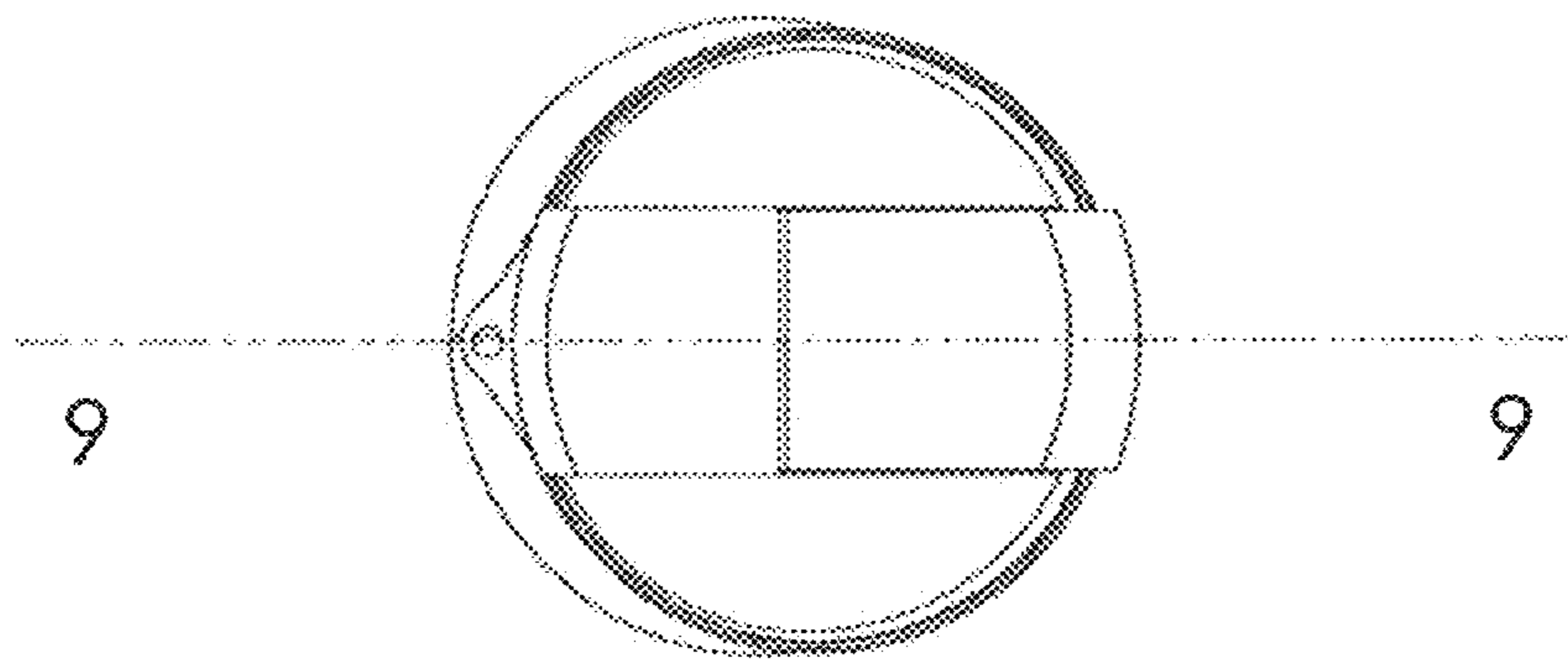

FIG. 10