

US00D764855S

(12) **United States Design Patent**  
**Stambolis**

(10) **Patent No.:** **US D764,855 S**  
(45) **Date of Patent:** **\*\* Aug. 30, 2016**

- (54) **SQUARE ARCH HANDLE**
- (71) Applicant: **RL Industry Company Ltd., Ningbo (CN)**
- (72) Inventor: **Petros Stambolis, New York, NY (US)**
- (73) Assignee: **RL INDUSTRY COMPANY LTD., Ningbo (CN)**
- (\*\*) Term: **14 Years**
- (21) Appl. No.: **29/487,861**
- (22) Filed: **Apr. 14, 2014**
- (51) **LOC (10) Cl.** ..... **07-02**
- (52) **U.S. Cl.**  
USPC ..... **D7/354**
- (58) **Field of Classification Search**  
USPC ..... D7/323, 354-361, 387, 543, 545, 549,  
D7/550.1, 552.1, 553.1-553.8,  
D7/554.1-554.4, 555, 584, 586, 602;  
D9/425, 428, 430-433, 455-456, 737,  
D9/756-762; D30/129  
CPC ..... A01K 5/0114; A01K 5/0128; A21B 3/00;  
A21B 3/13; A21B 3/15; A21B 3/134; A21B  
5/00; A21B 5/02; A47J 36/022; A47J 36/025;  
A47J 36/027; A47J 37/00; A47J 37/04;  
A47J 43/0727; B65D 1/22; B65D 1/24;  
B65D 1/34; B65D 1/36; B65D 21/0234;  
B65D 43/0206; B65D 51/1683; B65D 81/343;  
B65D 85/36  
See application file for complete search history.

D417,367 S *	12/1999	Laib .....	D7/360
D457,784 S *	5/2002	Torniainen .....	D7/543
D473,418 S *	4/2003	Burton .....	D7/354
D553,444 S *	10/2007	de Groot .....	D7/602
D564,711 S *	3/2008	Modi .....	D30/129
D572,077 S *	7/2008	Duke .....	D7/387
D573,414 S *	7/2008	Bellon .....	D7/602
D581,204 S *	11/2008	Simon .....	D7/354
D587,568 S *	3/2009	Shields .....	D9/425
D606,811 S *	12/2009	Furlong .....	D7/602
D612,663 S *	3/2010	Galperin .....	D7/354
D672,612 S *	12/2012	Stamper .....	D7/602
8,561,823 B1 *	10/2013	Krupa .....	B65D 21/0234 206/515
8,851,013 B2 *	10/2014	Tsengas .....	A01K 5/0114 119/61.3
D717,122 S *	11/2014	Carlson .....	D7/602
D734,991 S *	7/2015	Carlson .....	D7/602
D741,166 S *	10/2015	Tyberghein .....	D9/425
D754,466 S *	4/2016	Stambolis .....	D7/354
2006/0032852 A1 *	2/2006	Cai .....	B65D 51/1683 220/287
2009/0120937 A1 *	5/2009	Vovan .....	B65D 43/0206 220/266

\* cited by examiner

*Primary Examiner* — Ricky Pham  
(74) *Attorney, Agent, or Firm* — Mark M. Friedman

(57) **CLAIM**  
The ornamental design for a square arch handle, as shown and described.

**DESCRIPTION**

FIG. 1 is a front view of a square arch handle showing my design;  
FIG. 2 is a right side view thereof;  
FIG. 3 is a left side view thereof;  
FIG. 4 is a top view thereof;  
FIG. 5 is a cross-sectional view taken along line 5-5 of FIG. 4 thereof;  
FIG. 6 is a bottom view thereof; and,  
FIG. 7 is a perspective view thereof.  
The broken lines in the drawings depict environmental subject matter only and form no part of the claimed design.

**1 Claim, 7 Drawing Sheets**

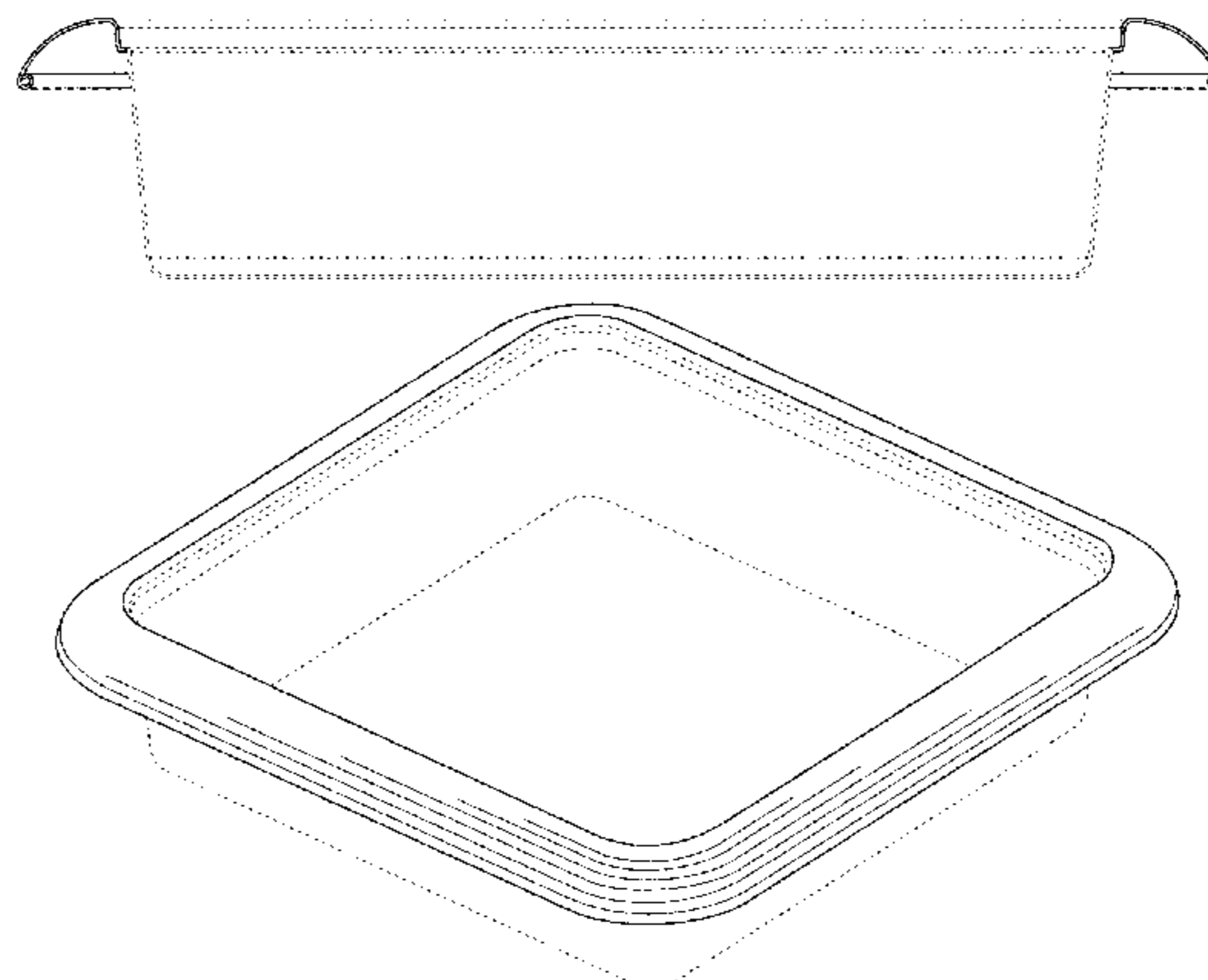

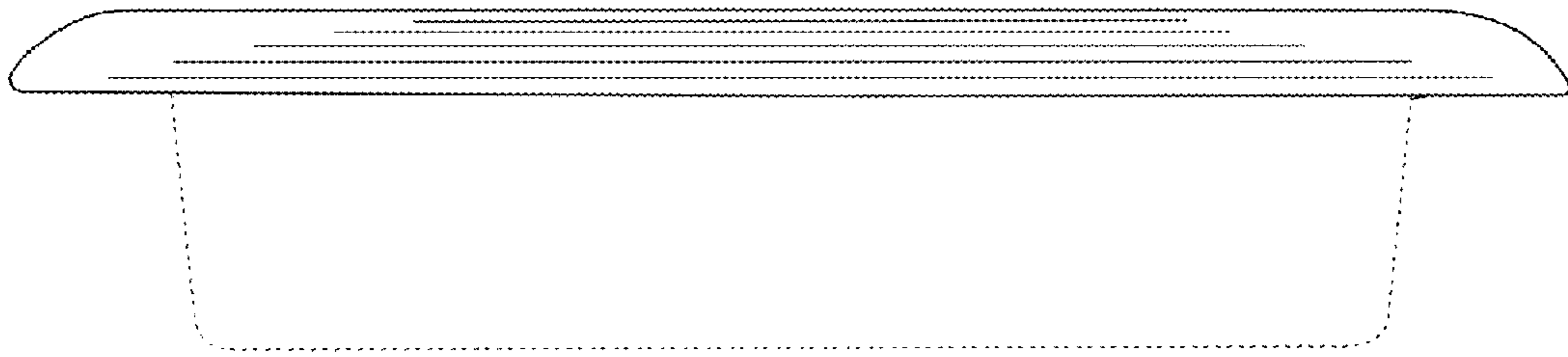

FIG. 1

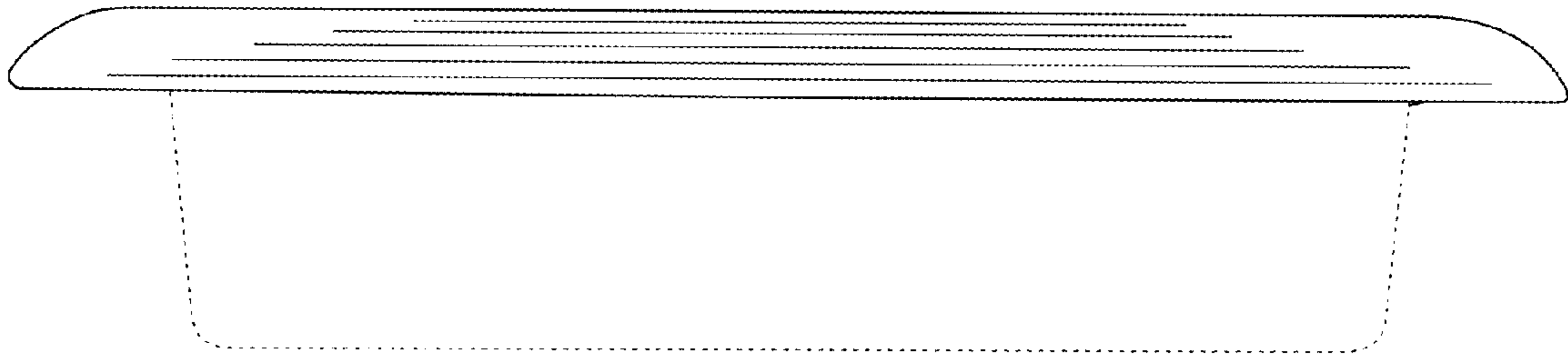

FIG. 2

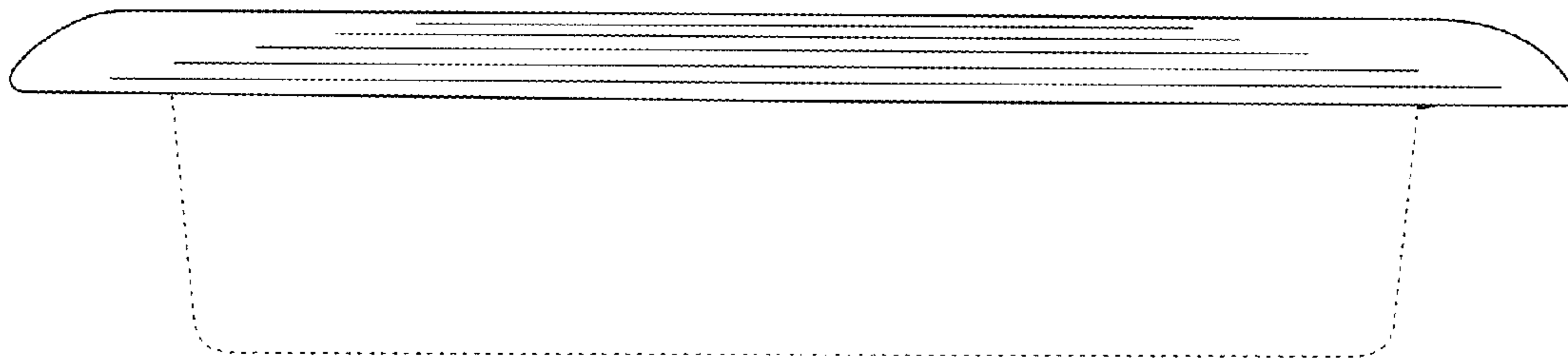

FIG. 3

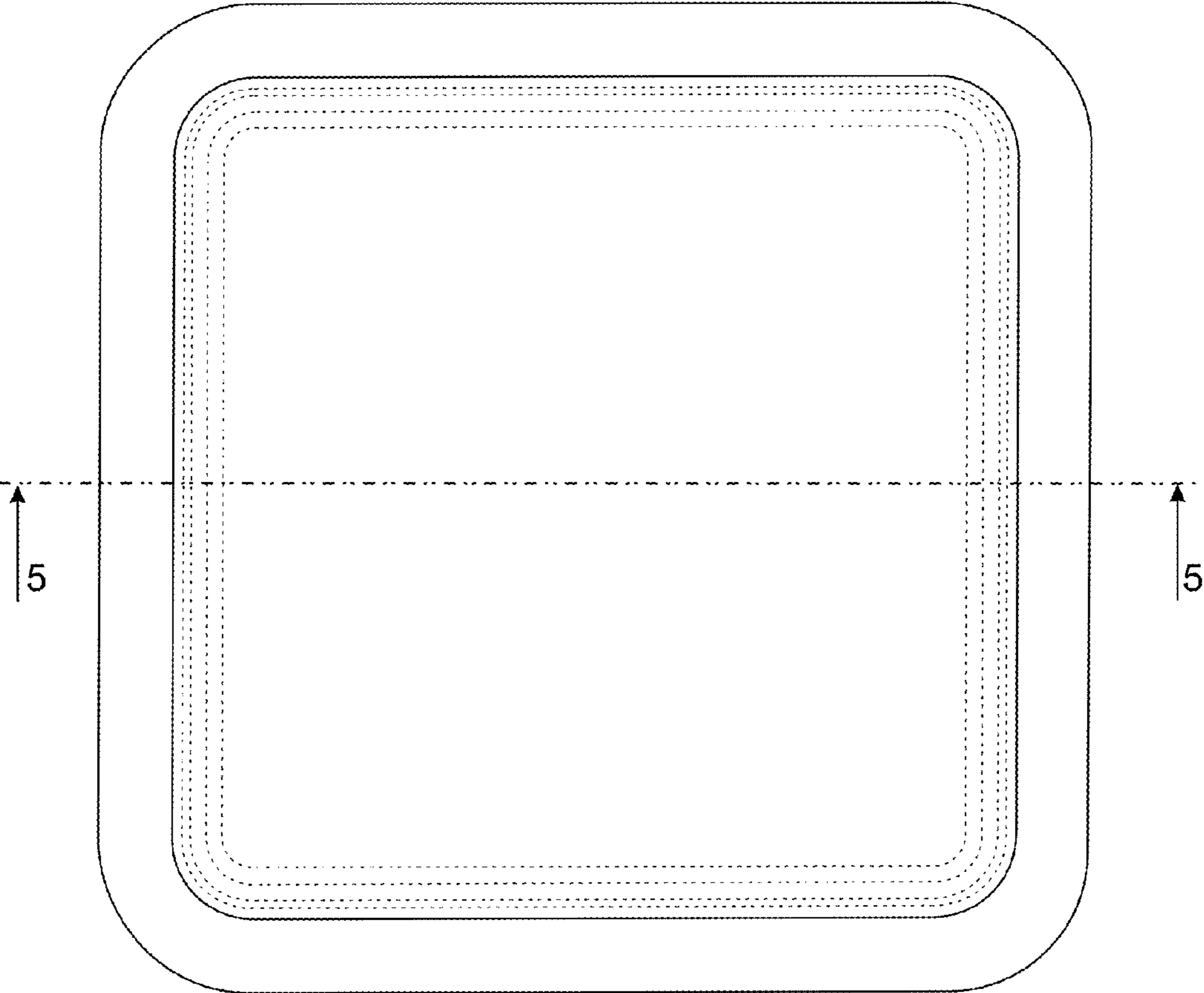

FIG. 4

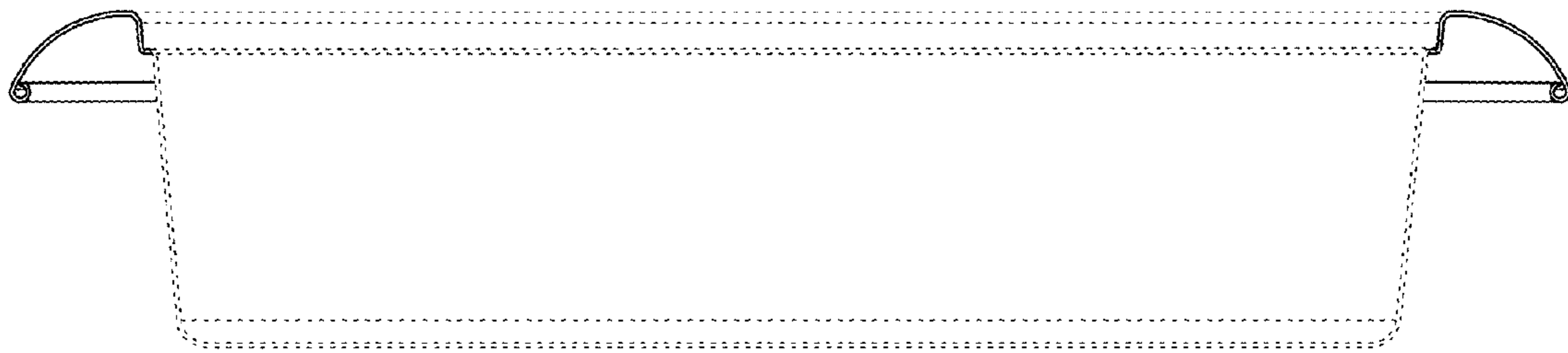

FIG. 5

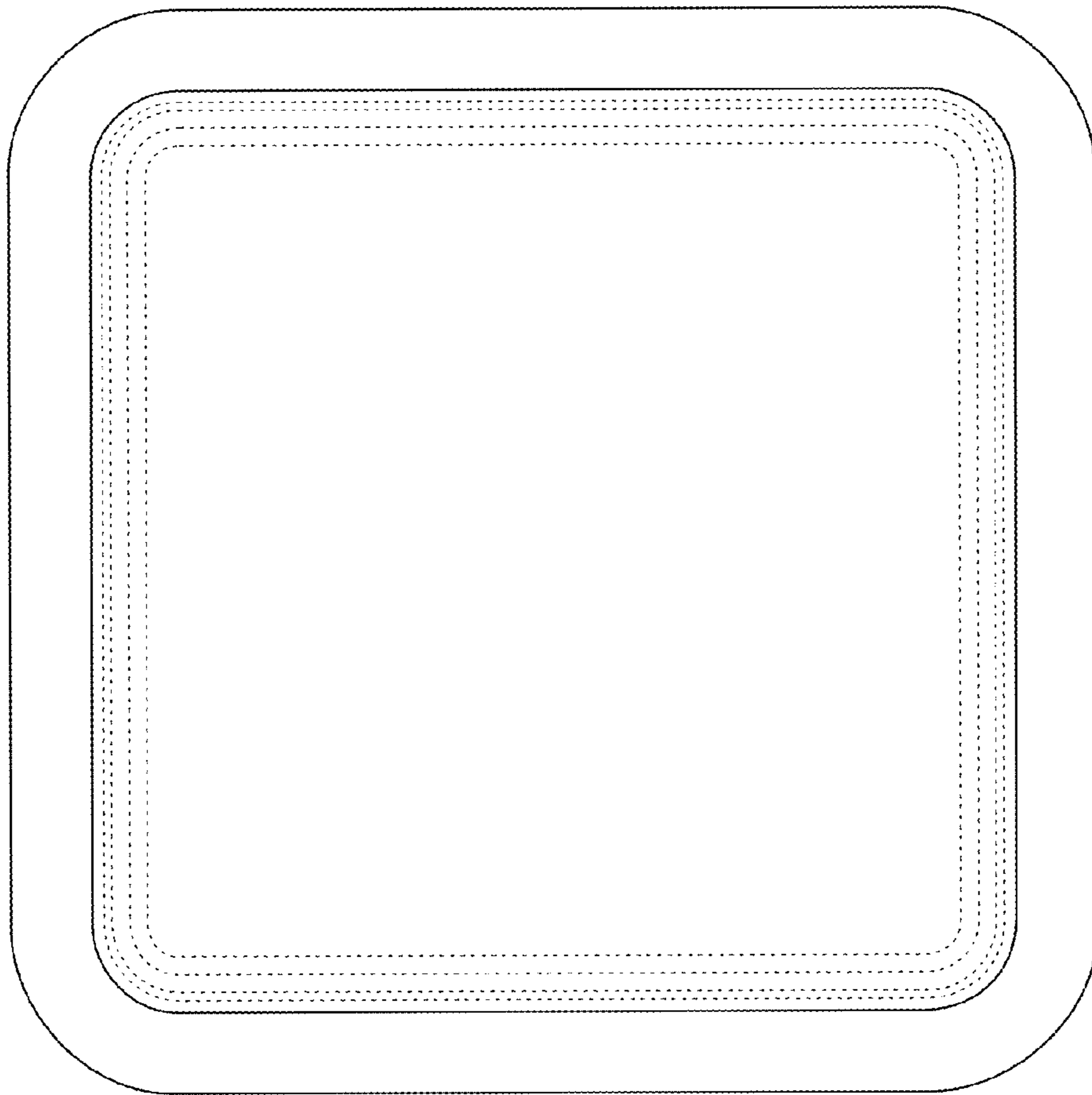

FIG. 6

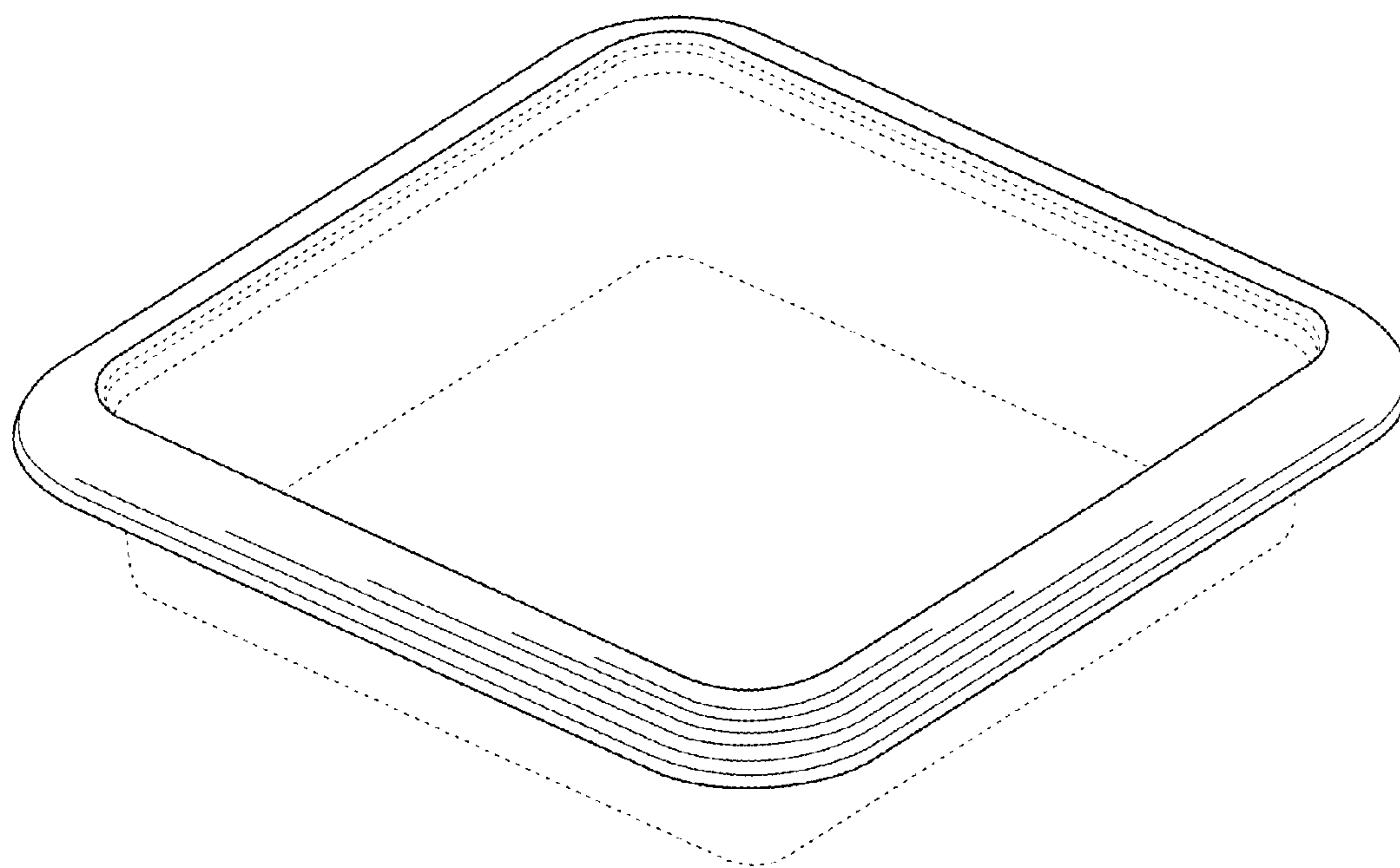

FIG. 7