



US00D764790S

(12) **United States Design Patent**
Vruwink

(10) **Patent No.:** **US D764,790 S**

(45) **Date of Patent:** **** Aug. 30, 2016**

(54) **FLEXIBLE CARRY AND DISPLAY BAG**

(71) Applicant: **Springs Global US, Inc.**, Fort Mill, SC (US)

(72) Inventor: **Jennifer Vruwink**, Charlotte, NC (US)

(73) Assignee: **Springs Global US, Inc.**, Fort Mill, SC (US)

(**) Term: **15 Years**

(21) Appl. No.: **29/527,709**

(22) Filed: **May 21, 2015**

(51) **LOC (10) Cl.** **03-01**

(52) **U.S. Cl.**
USPC **D3/232**

(58) **Field of Classification Search**
USPC D3/232-233, 240-243, 245-246
CPC A45C 1/024; A45C 3/06
See application file for complete search history.

(56) **References Cited**

U.S. PATENT DOCUMENTS

D366,757 S	*	2/1996	Marino	D3/218
D367,167 S	*	2/1996	Marino	D3/218
D463,121 S	*	9/2002	DeChant	D3/276
D530,917 S	*	10/2006	Conforti	D3/299
D716,048 S	*	10/2014	Bradfield	D3/303
D731,493 S	*	6/2015	Mills	D14/440

* cited by examiner

Primary Examiner — Holly Baynham

(74) *Attorney, Agent, or Firm* — Myers Bigel & Sibley

(57) **CLAIM**

The ornamental design for a flexible carry and display bag, as shown and described.

DESCRIPTION

FIG. 1 is a top, perspective view of a flexible carry and display bag, showing my new design;
 FIG. 2 is a top plan view thereof;
 FIG. 3 is a bottom plan view thereof, opposite that shown in FIG. 2;
 FIG. 4 is a side view thereof;
 FIG. 5 is a side view thereof, opposite that shown in FIG. 4;
 FIG. 6 is an end view thereof;
 FIG. 7 is an end view thereof, opposite that shown in FIG. 6;
 FIG. 8 is a top, front perspective view of the flexible carry and display bag of FIGS. 1-7 in a display/carry configuration and illustrating exemplary contents (shown as pillows) therewithin;
 FIG. 9 is a front view thereof;
 FIG. 10 is a rear view thereof, opposite that shown in FIG. 9;
 FIG. 11 is a top view thereof;
 FIG. 12 is a bottom view thereof;
 FIG. 13 is a side view thereof;
 FIG. 14 is a side view thereof, opposite that shown in FIG. 13; and,
 FIG. 15 is a top, perspective view of the flexible carry and display bag of FIGS. 8-14 in a flat configuration.
 The broken lines showing wallet contents are for the purposes of illustrating environment and form no part of the claimed design.
 The broken lines showing a handle and stitching are part of the claim design.

1 Claim, 11 Drawing Sheets

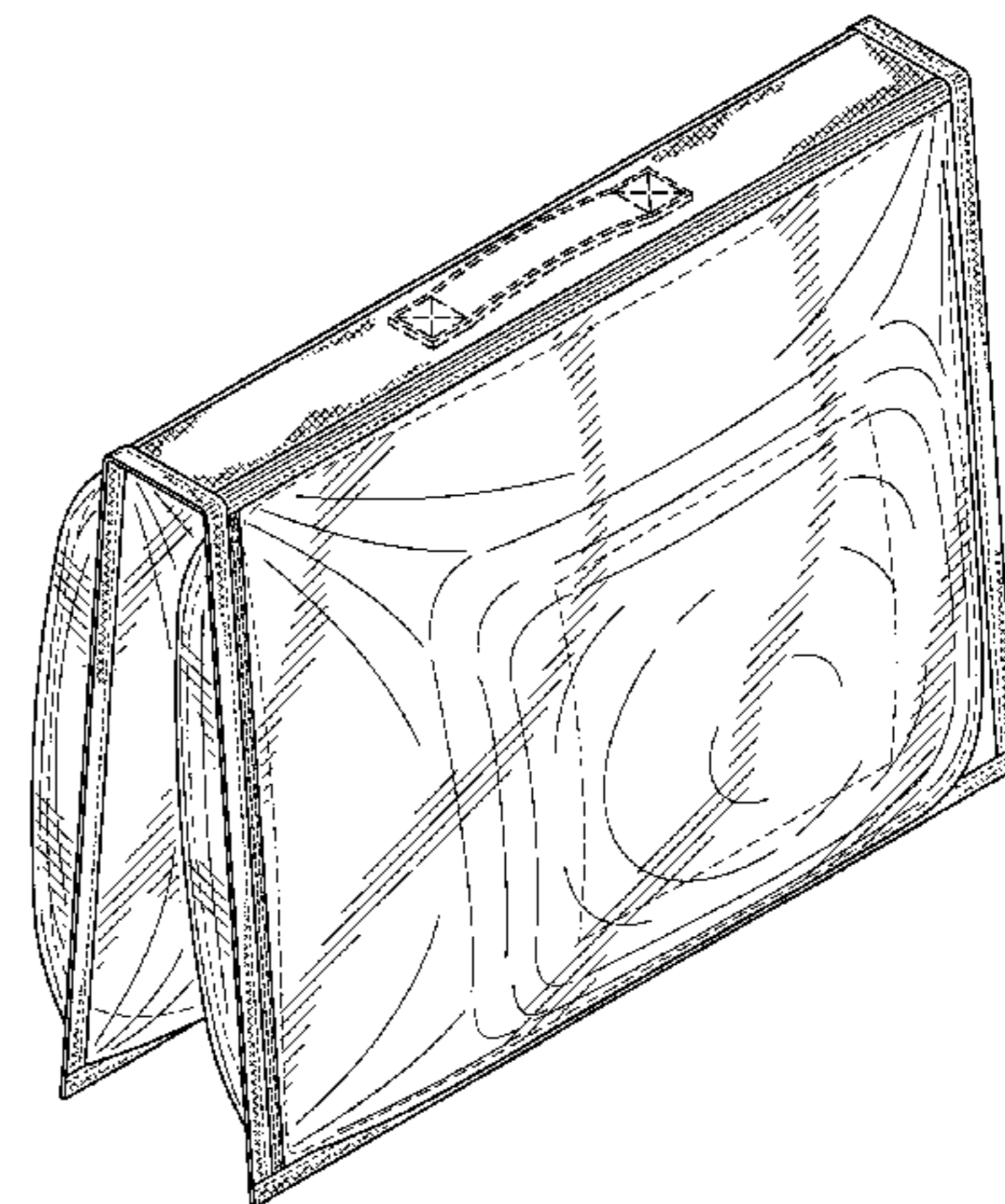
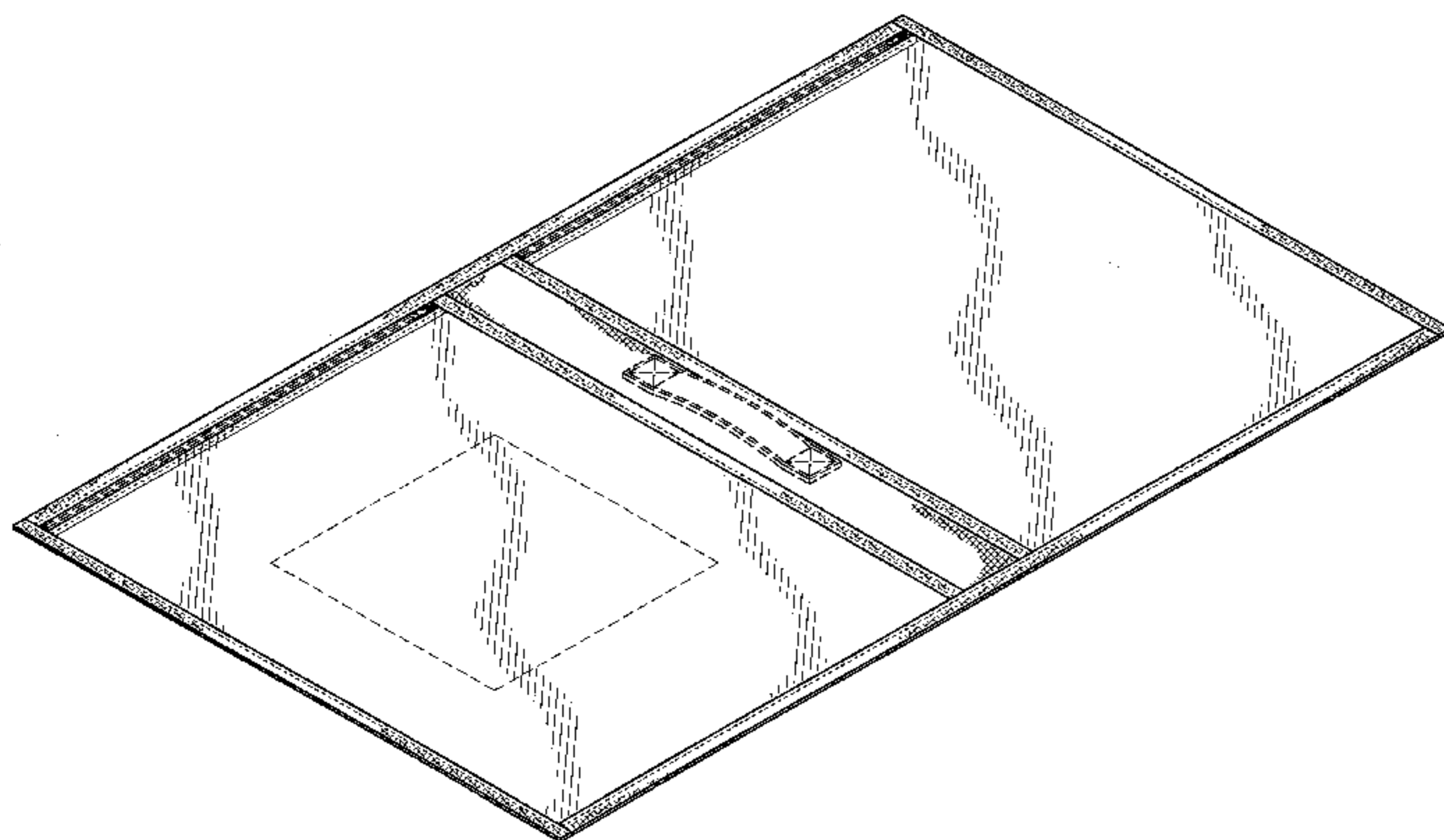

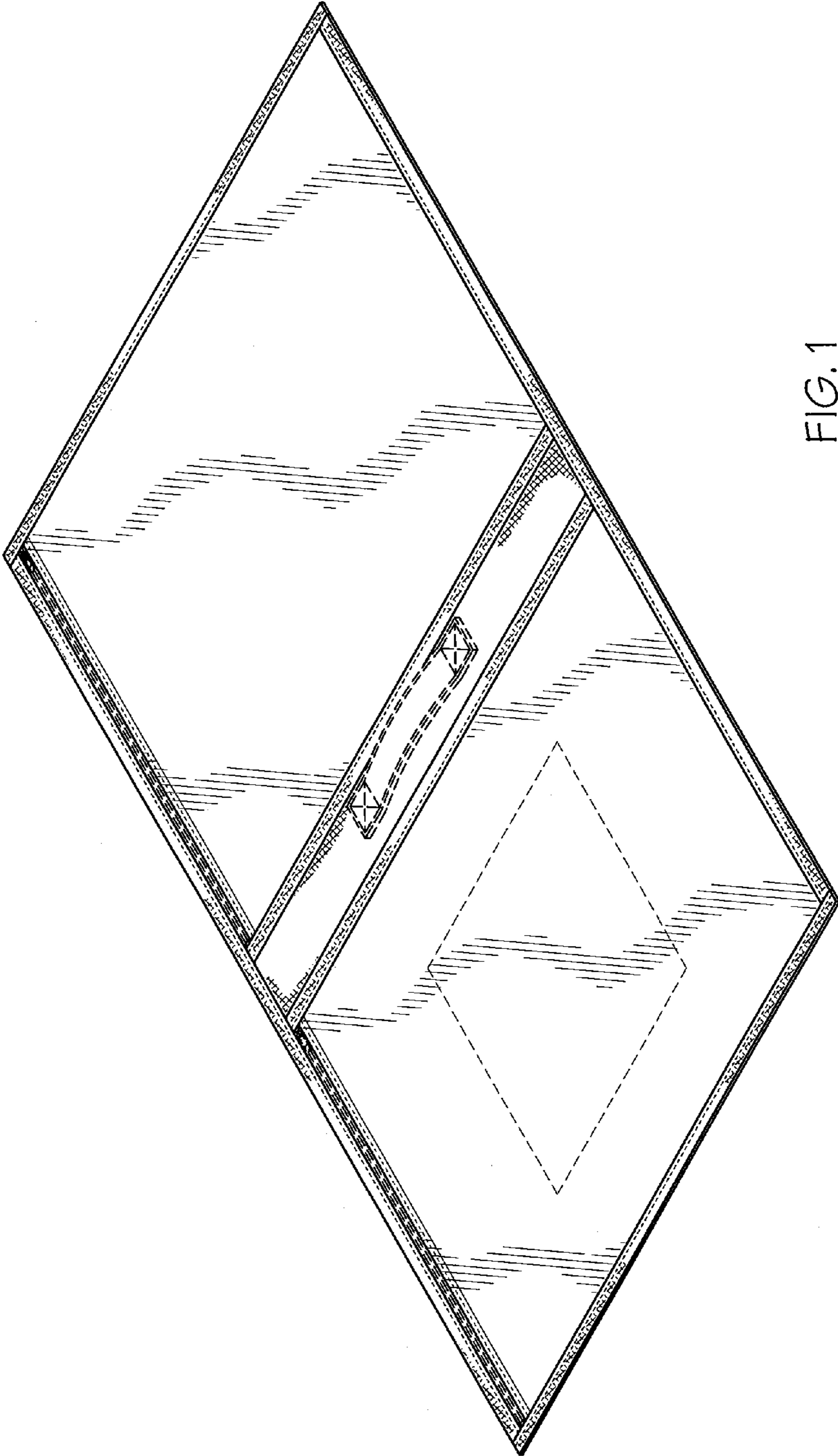

FIG. 1

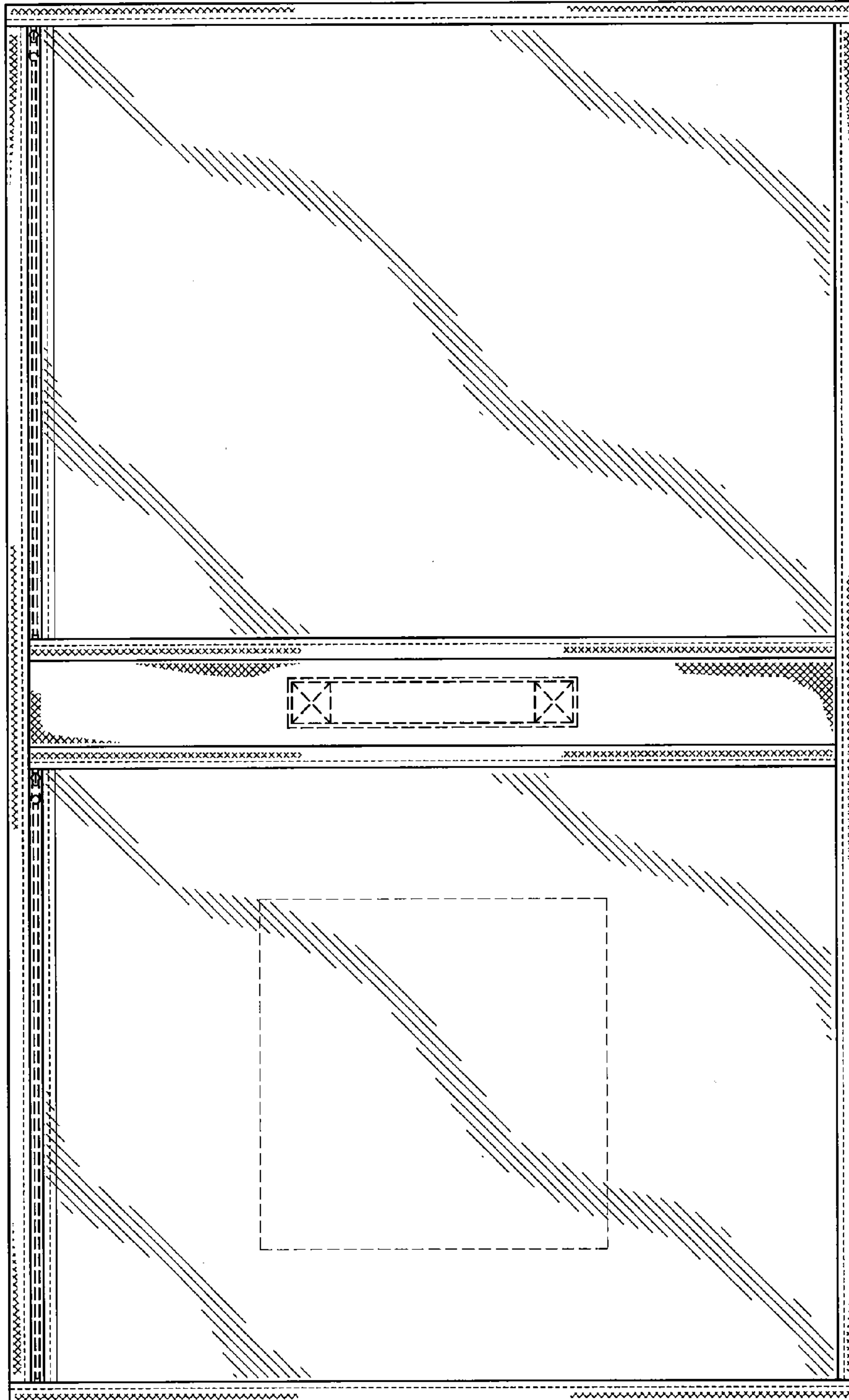

FIG. 2

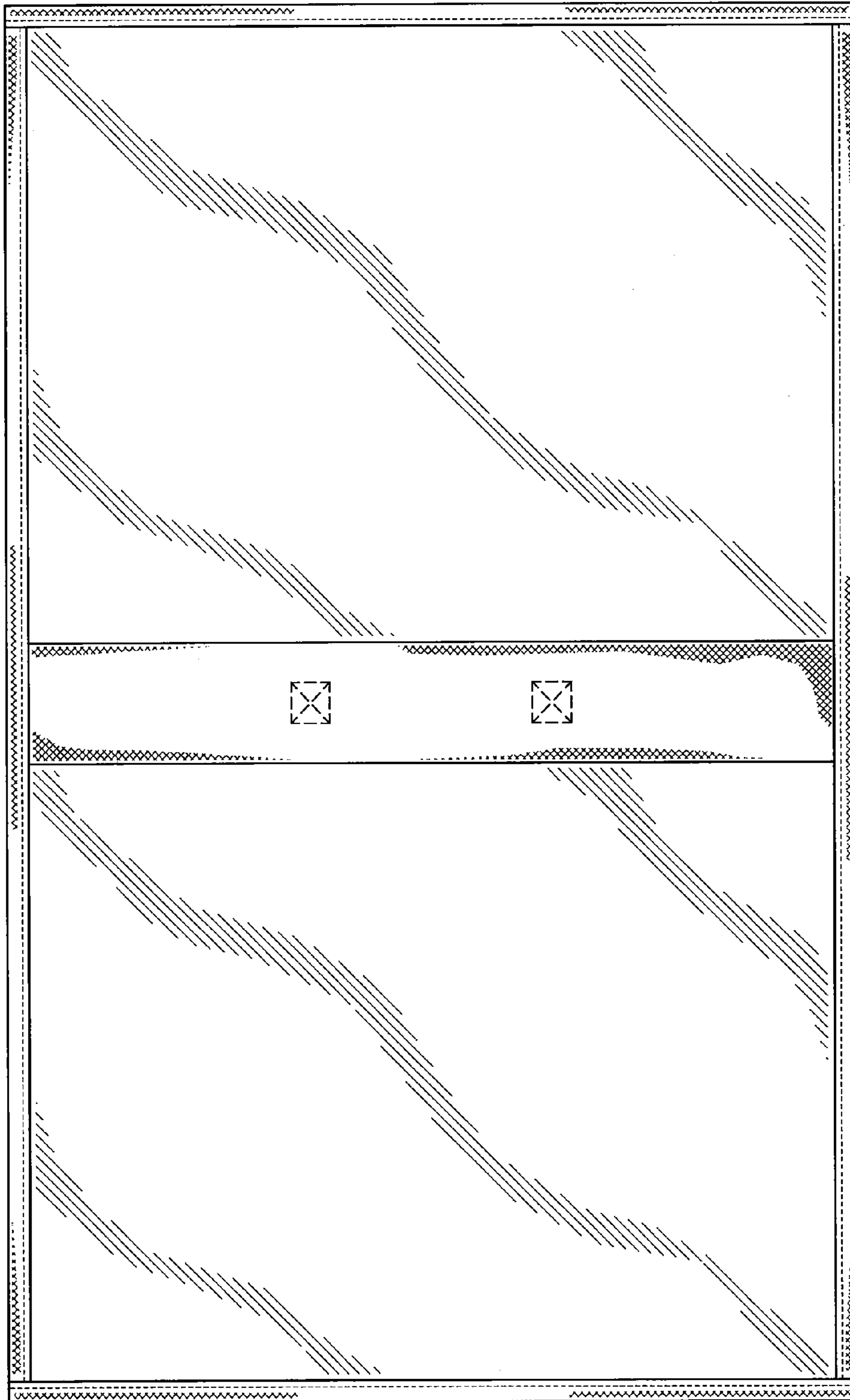

FIG. 3



FIG. 4



FIG. 5



FIG. 6



FIG. 7

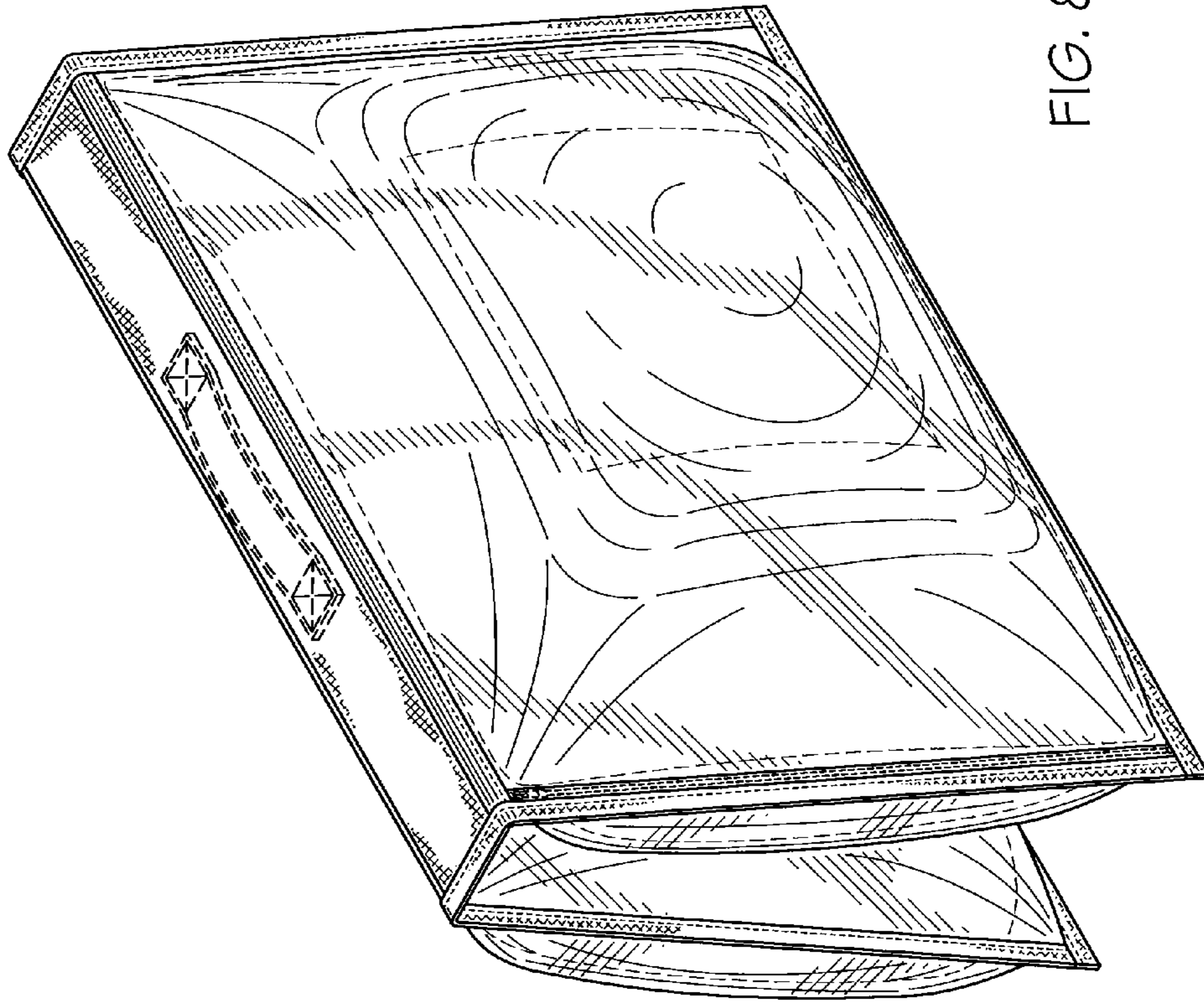

FIG. 8

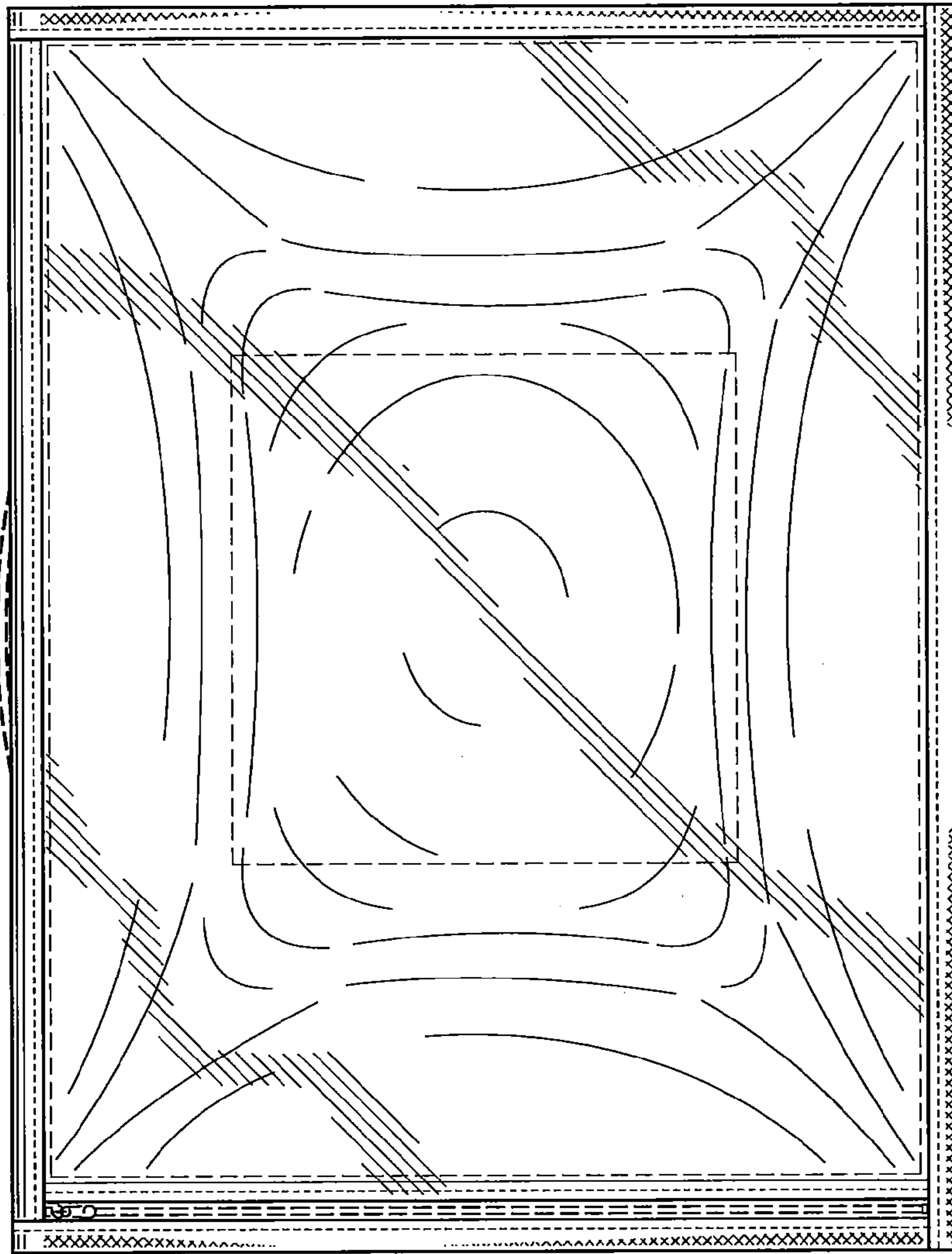

FIG. 9

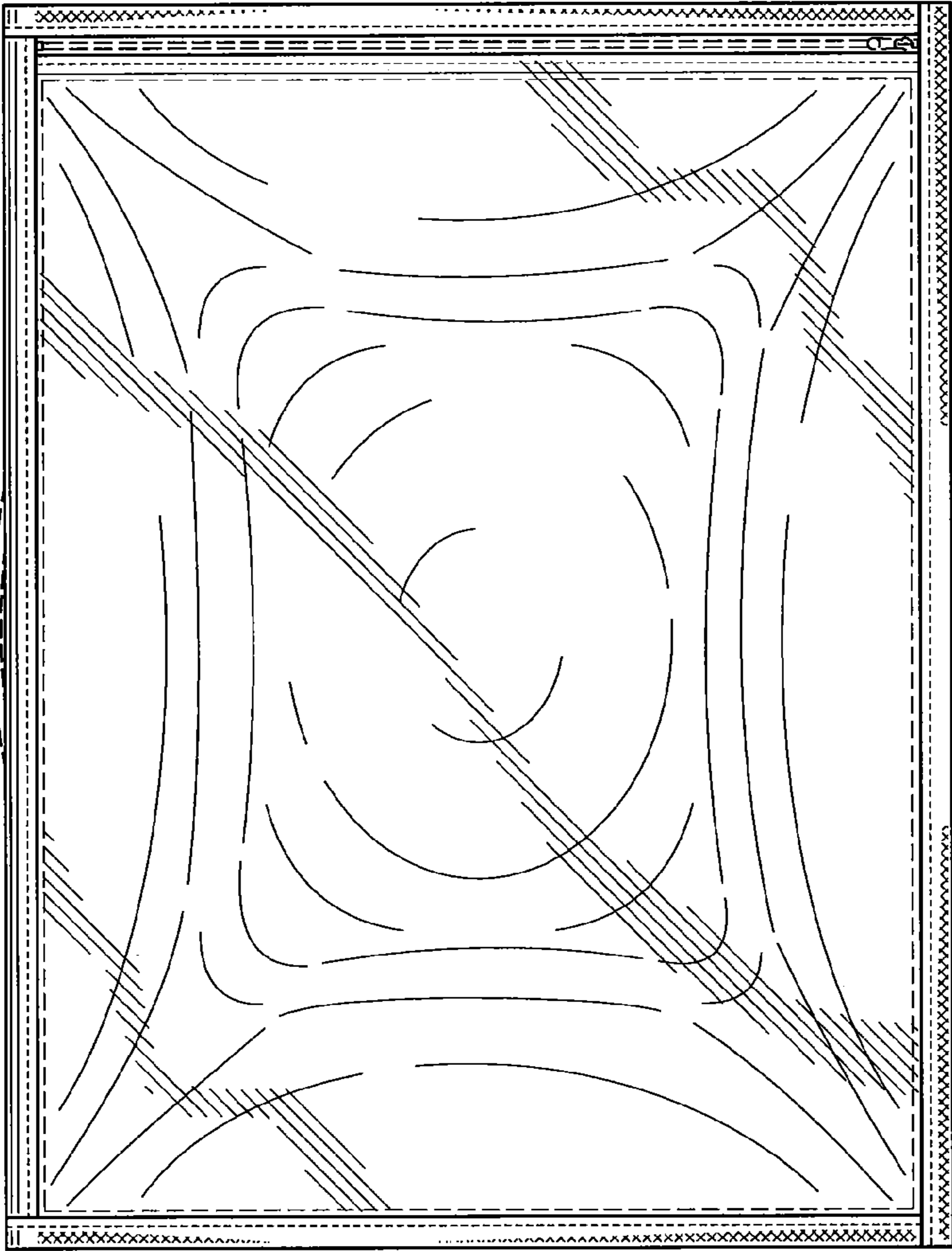

FIG. 10

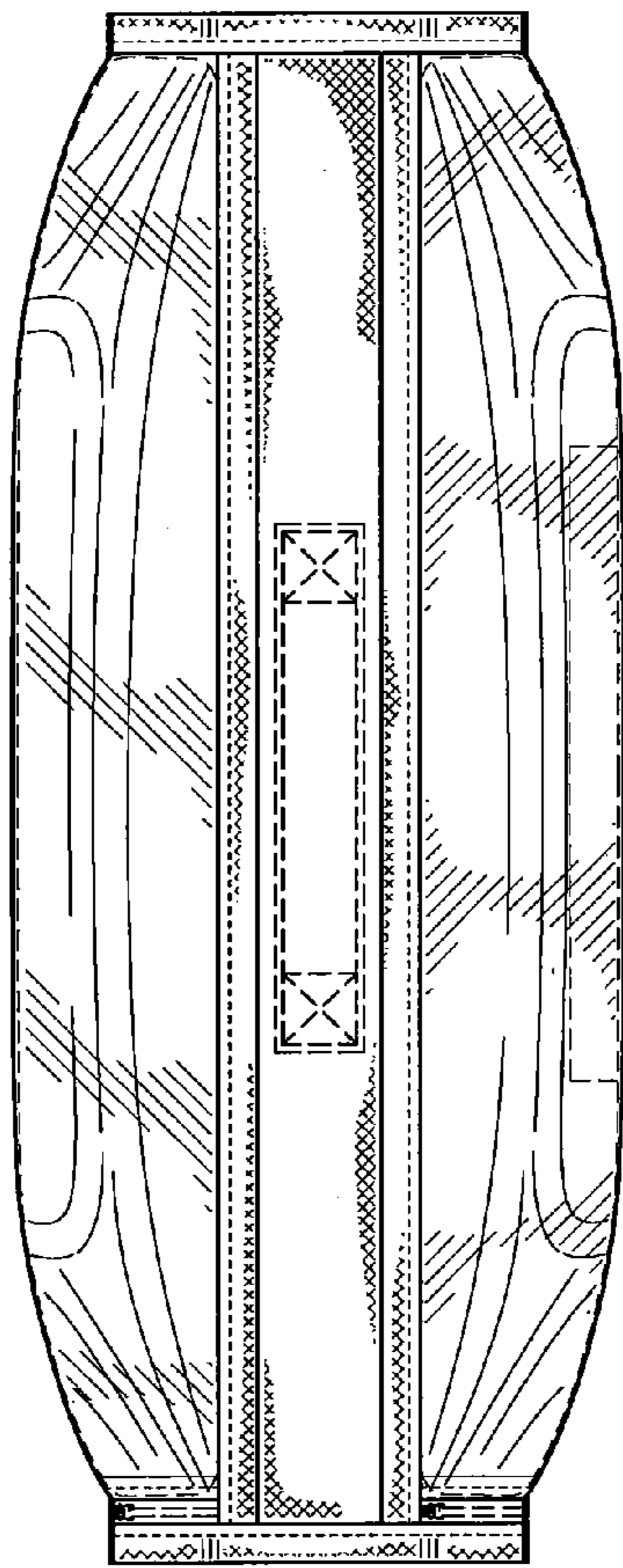

FIG. 11

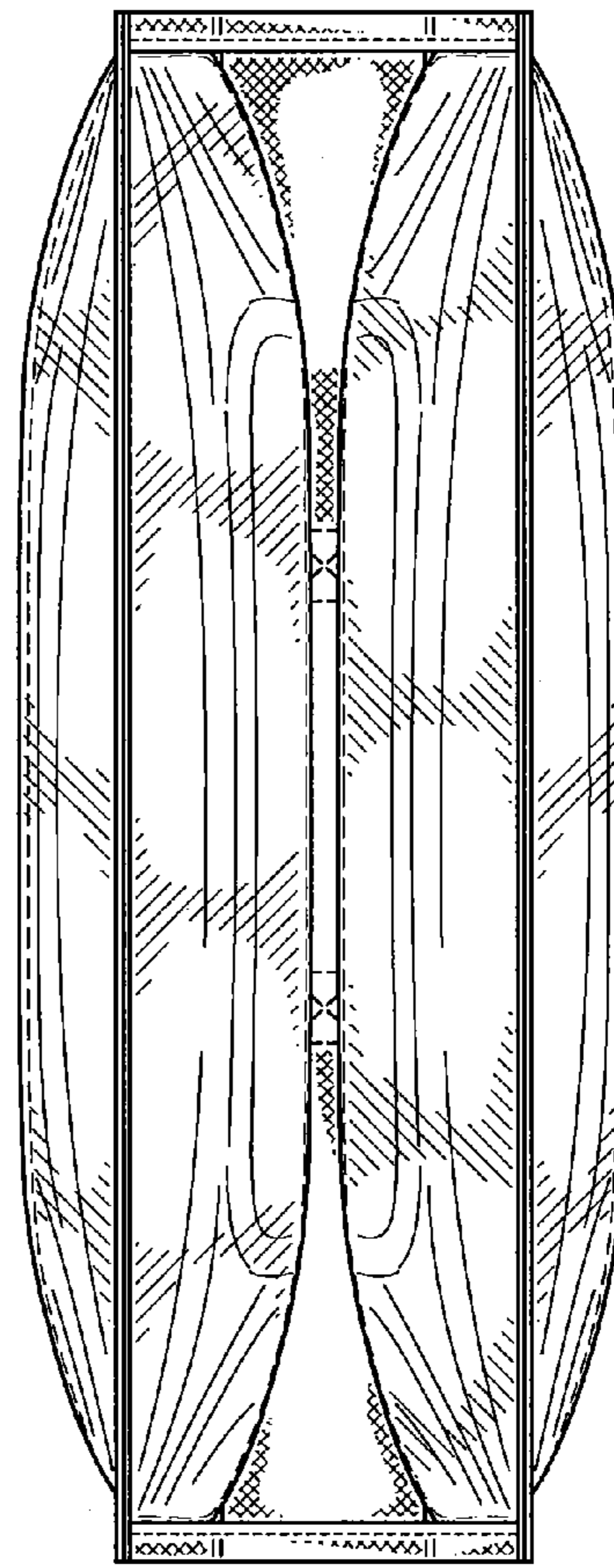

FIG. 12

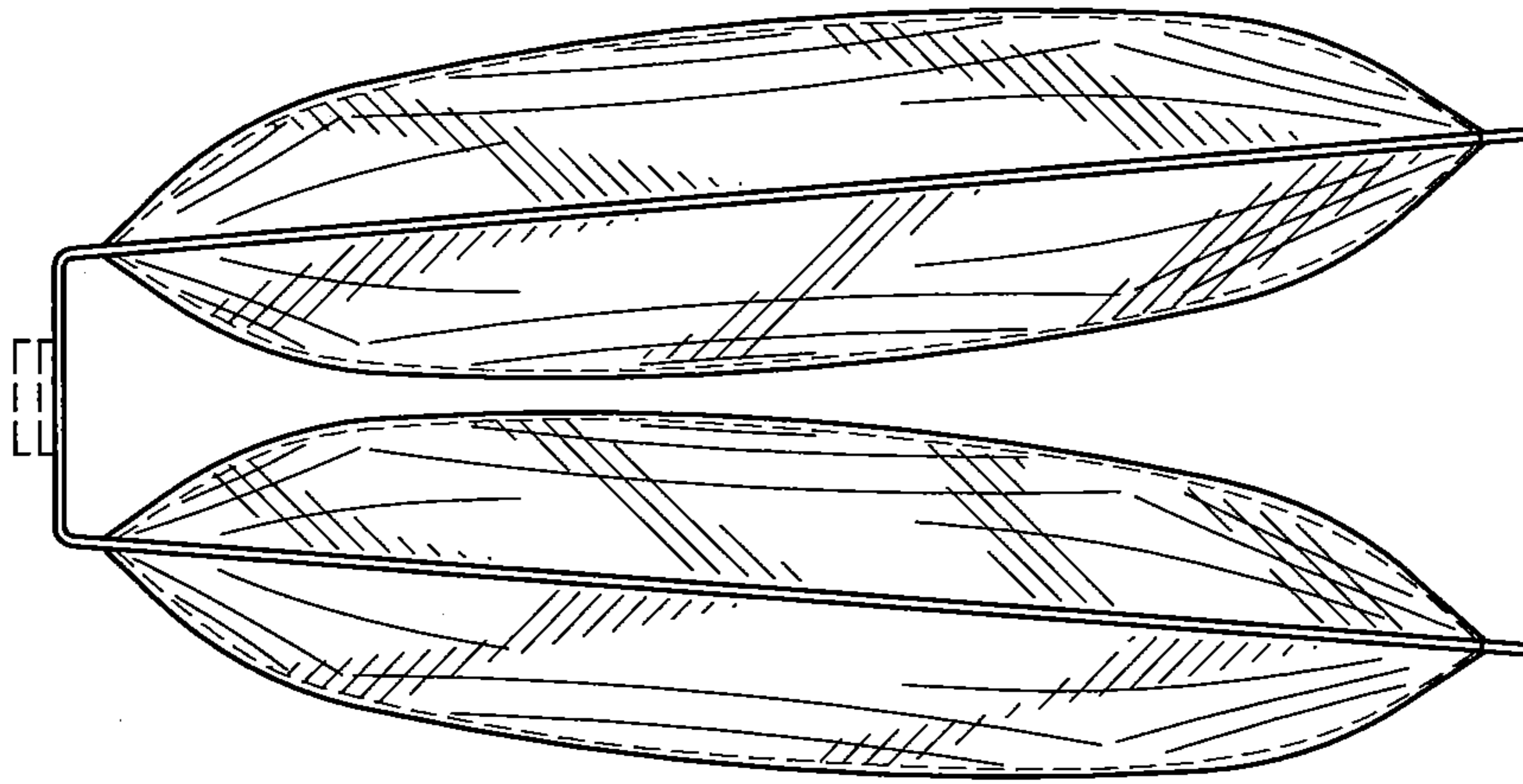

FIG. 14

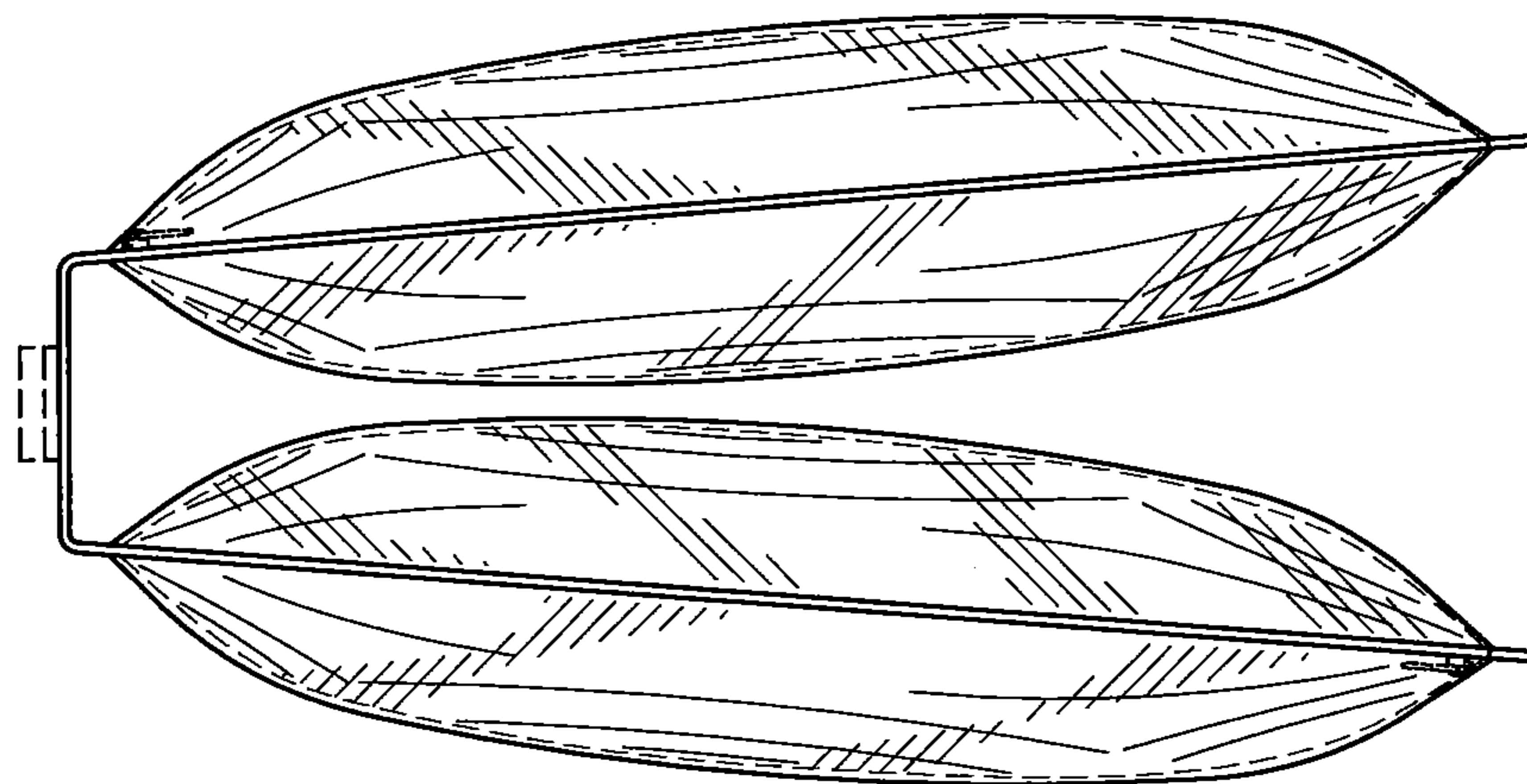

FIG. 13

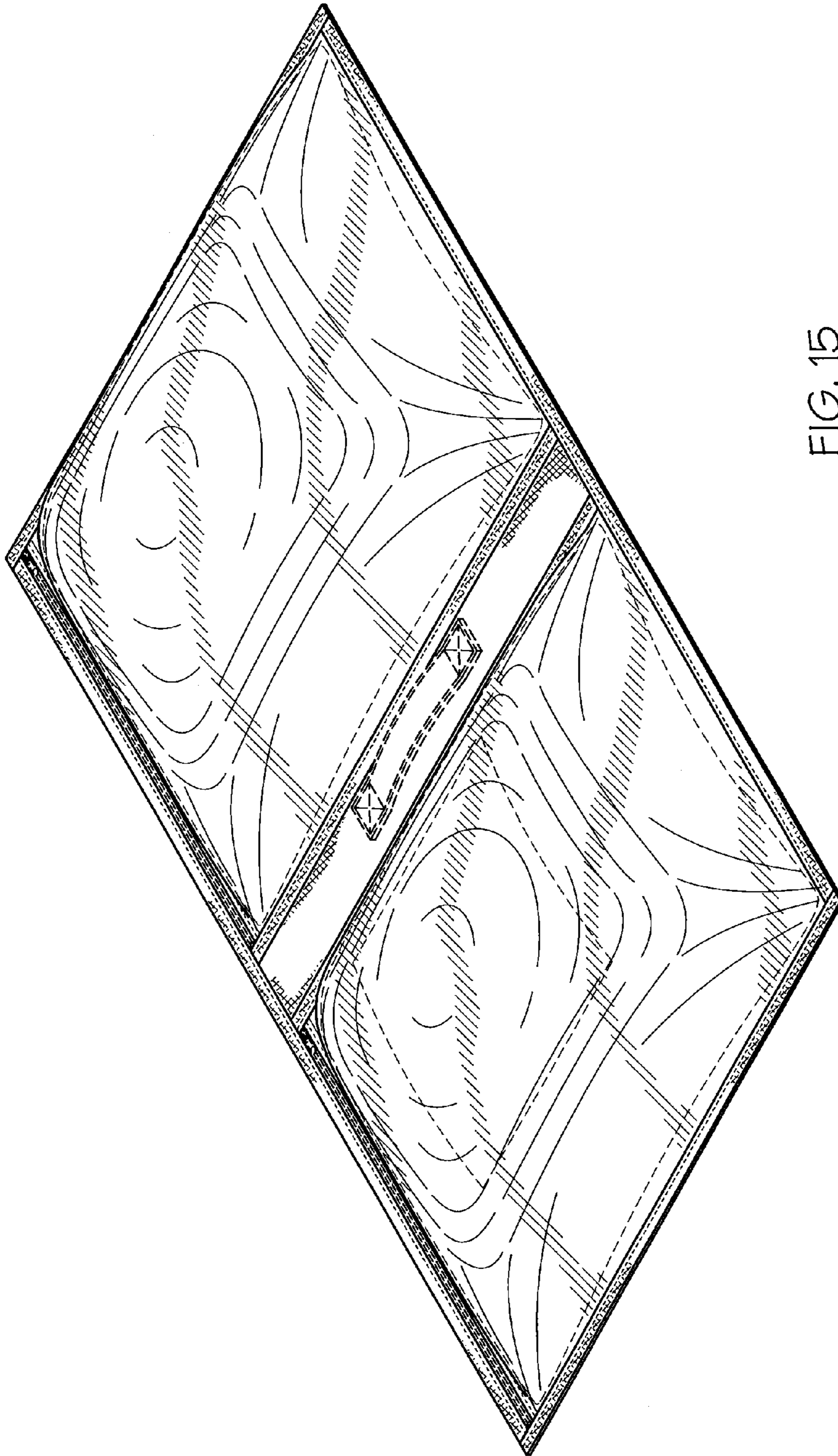

FIG. 15