



US00D764711S

(12) **United States Design Patent**  
**Teller et al.**

(10) **Patent No.:** **US D764,711 S**

(45) **Date of Patent:** **\*\* \*Aug. 23, 2016**

(54) **COSMETIC PRODUCT CONTAINER**

(71) Applicant: **EOS PRODUCTS, LLC**, New York, NY (US)

(72) Inventors: **Jonathan Teller**, New York, NY (US);  
**Sanjiv Mehra**, New York, NY (US);  
**Peter Waxman**, New York, NY (US);  
**Joseph Speter**, New York, NY (US);  
**Sherry Jhavar**, New York, NY (US);  
**Hamish Campbell**, New York, NY (US)

(73) Assignee: **EOS PRODUCTS, LLC**, New York, NY (US)

(\*) Notice: This patent is subject to a terminal disclaimer.

(\*\*) Term: **14 Years**

(21) Appl. No.: **29/488,096**

(22) Filed: **Apr. 15, 2014**

(51) **LOC (10) Cl.** ..... **28-03**

(52) **U.S. Cl.**  
USPC ..... **D28/82; D28/88; D9/519; D9/552; D9/554**

(58) **Field of Classification Search**

USPC ..... D28/85-91, 82, 76-79, 4-7, 8.1, 8.2, 9;  
D9/502, 570, 503, 504, 519, 552, 554,  
D9/557, 564, 566, 567, 600, 726, 601, 551,  
D9/521, 416, 529, 438, 435; D24/101,  
D24/102; D1/127, 130; D5/43, 44, 56, 59,  
D5/60, 62, 55; 132/316, 317, 318, 320;  
206/581, 823, 385; D3/265, 270,  
D3/271.1; 424/467; D14/489

CPC ..... B65D 1/00; B65D 3/00; B65D 5/00;  
B65D 11/00; B65D 25/00; B65D 81/00

See application file for complete search history.

(56) **References Cited**

U.S. PATENT DOCUMENTS

1,852,455	A	4/1932	Friedman	
2,745,642	A *	5/1956	Hermann	366/130
3,167,079	A *	1/1965	Weil	134/137
3,292,840	A *	12/1966	Schmidt	220/4.25
3,494,515	A *	2/1970	Fattori	222/548
4,765,501	A *	8/1988	Kao	220/4.21
5,044,496	A	9/1991	Tanaka	
D322,558	S *	12/1991	Halm et al.	D32/29.1
D378,275	S *	3/1997	Rusnock et al.	D9/545

(Continued)

FOREIGN PATENT DOCUMENTS

JP	1136041	S	3/2002
JP	2001321140	A	11/2004

OTHER PUBLICATIONS

SIPO Office Action issued Jul. 17, 2014 in connection with CN Appl. No. 201080063211.X citing JP 2004-321410A and JP 1136041S.

*Primary Examiner* — Marianne Pandozzi

*Assistant Examiner* — Jae Liang

(74) *Attorney, Agent, or Firm* — Martin & Ferraro, LLP

(57) **CLAIM**

The ornamental design for a cosmetic product container, as shown and described.

**DESCRIPTION**

FIG. 1 is a front elevational view of a cosmetic product container showing my new design;  
FIG. 2 is a right side elevational view thereof;  
FIG. 3 is a left side elevational view thereof;  
FIG. 4 is a rear elevational view thereof;  
FIG. 5 is a top plan view thereof; and,  
FIG. 6 is a bottom plan view thereof.

The broken lines in the drawing depict portions of the cosmetic product container that form no part of the claimed design.

The stippling in FIGS. 1-6 shows contrast in appearance.

**1 Claim, 3 Drawing Sheets**

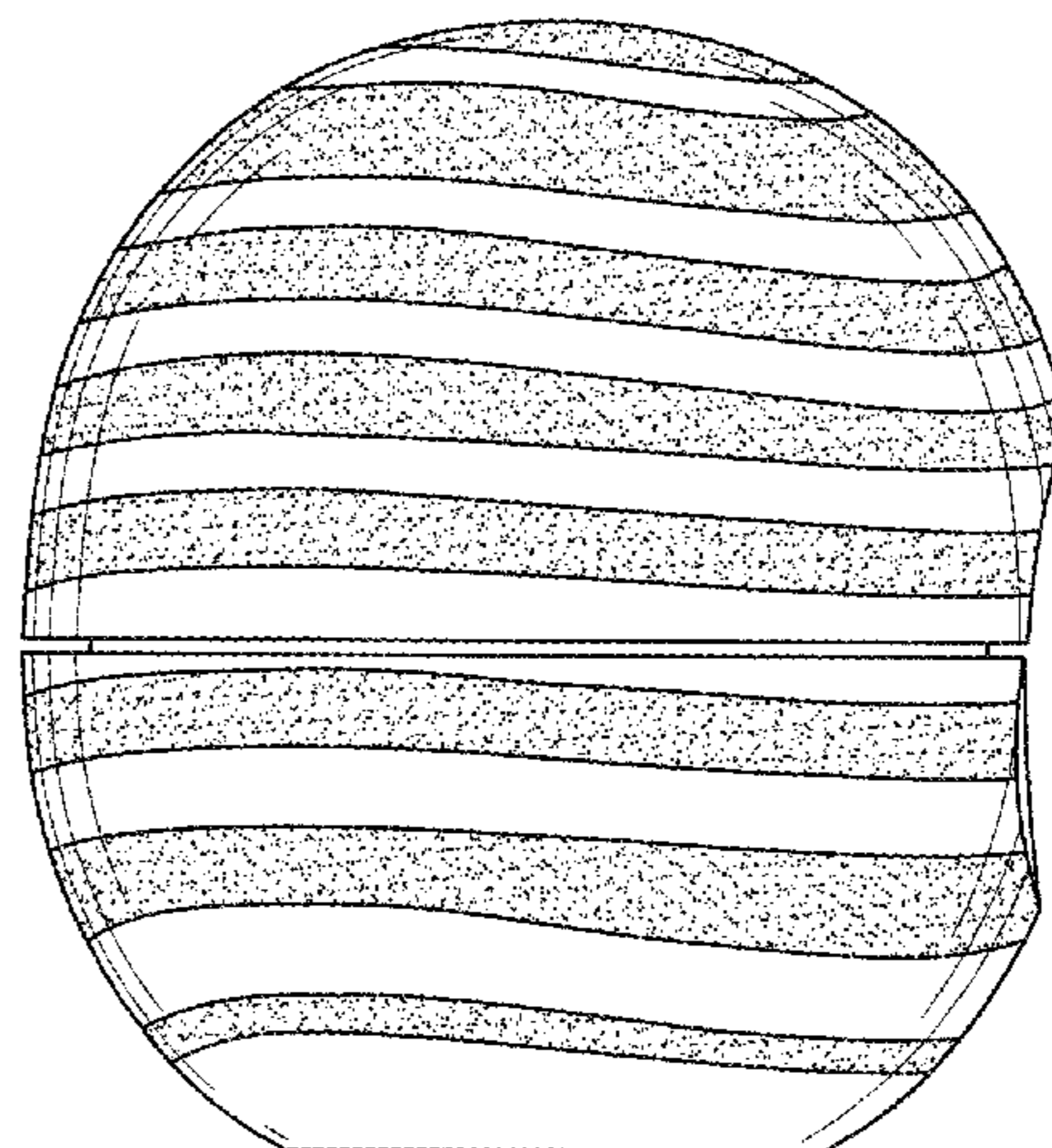
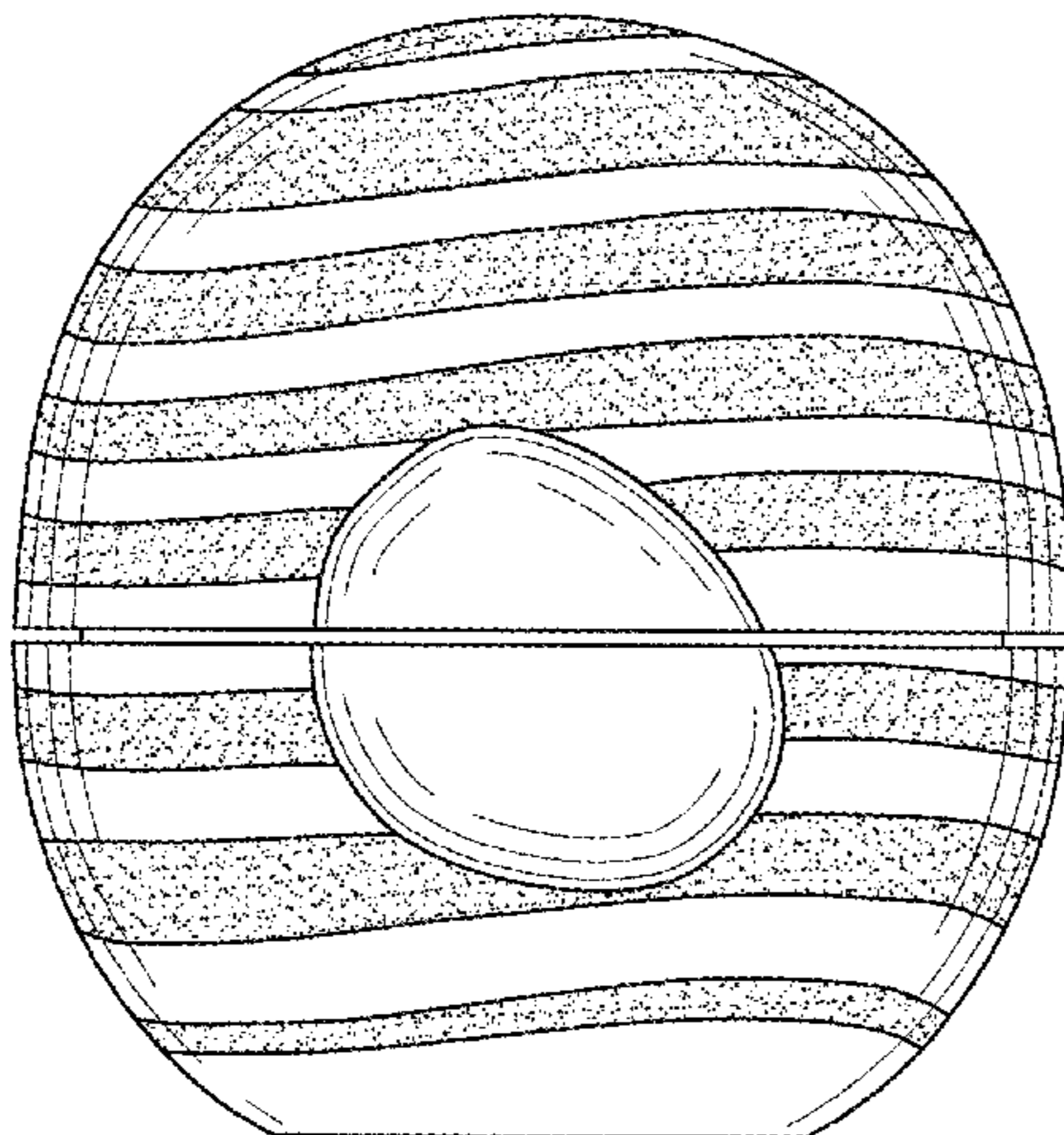

(56)

References Cited

U.S. PATENT DOCUMENTS

D396,382 S *	7/1998	Hsu	.....	D7/599	D564,900 S *	3/2008	Green et al.	.....	D9/715
D403,123 S *	12/1998	Sgariboldi	.....	D28/76	D570,219 S *	6/2008	Blasko	.....	D9/516
6,193,427 B1	2/2001	Benguigui			D579,213 S *	10/2008	Aipa	.....	D5/53
D443,826 S *	6/2001	Gnann et al.	.....	D9/537	D592,064 S *	5/2009	Kilany	.....	D9/519
D450,882 S *	11/2001	Colwell et al.	.....	D28/4	D592,512 S *	5/2009	Dubitsky et al.	.....	D9/516
D452,586 S *	12/2001	Look	.....	D28/4	D599,560 S *	9/2009	Sharma	.....	D5/59
D452,588 S *	12/2001	Look	.....	D28/4	D609,107 S *	2/2010	Dubitsky et al.	.....	D9/551
6,391,972 B1	5/2002	Hatakeyama			D612,245 S *	3/2010	Canamasas Puigbo	.....	D9/519
D465,609 S *	11/2002	Jackel-Marken	.....	D28/4	D625,469 S *	10/2010	Dubitsky et al.	.....	D28/84
D465,733 S *	11/2002	Hill	.....	D9/519	D631,204 S *	1/2011	Dubitsky et al.	.....	D28/82
D472,014 S *	3/2003	Jackel-Marken	.....	D28/4	D644,939 S *	9/2011	Teller	.....	D9/726
D512,199 S *	12/2005	Ibanez	.....	D1/129	8,444,337 B2 *	5/2013	Teller	.....	401/88
D516,431 S *	3/2006	Vintro	.....	D9/521	D688,000 S *	8/2013	Johnson et al.	.....	D28/4
D525,437 S *	7/2006	Leisch et al.	.....	D5/53	D689,366 S *	9/2013	Kohne et al.	.....	D9/504
D537,563 S *	2/2007	Taniguchi et al.	.....	D28/4	D695,552 S *	12/2013	Gatto	.....	D6/606
D541,052 S *	4/2007	Miller et al.	.....	D5/53	D705,988 S *	5/2014	Scott et al.	.....	D28/7
D552,997 S *	10/2007	Blasko	.....	D9/521	D708,726 S *	7/2014	Gordon et al.	.....	D23/356
D554,529 S *	11/2007	Green et al.	.....	D9/726	D710,544 S *	8/2014	Shen	.....	D28/77
					D715,142 S *	10/2014	Allen et al.	.....	D9/434
					D726,028 S *	4/2015	Thompson	.....	D9/726

\* cited by examiner



FIG. 1

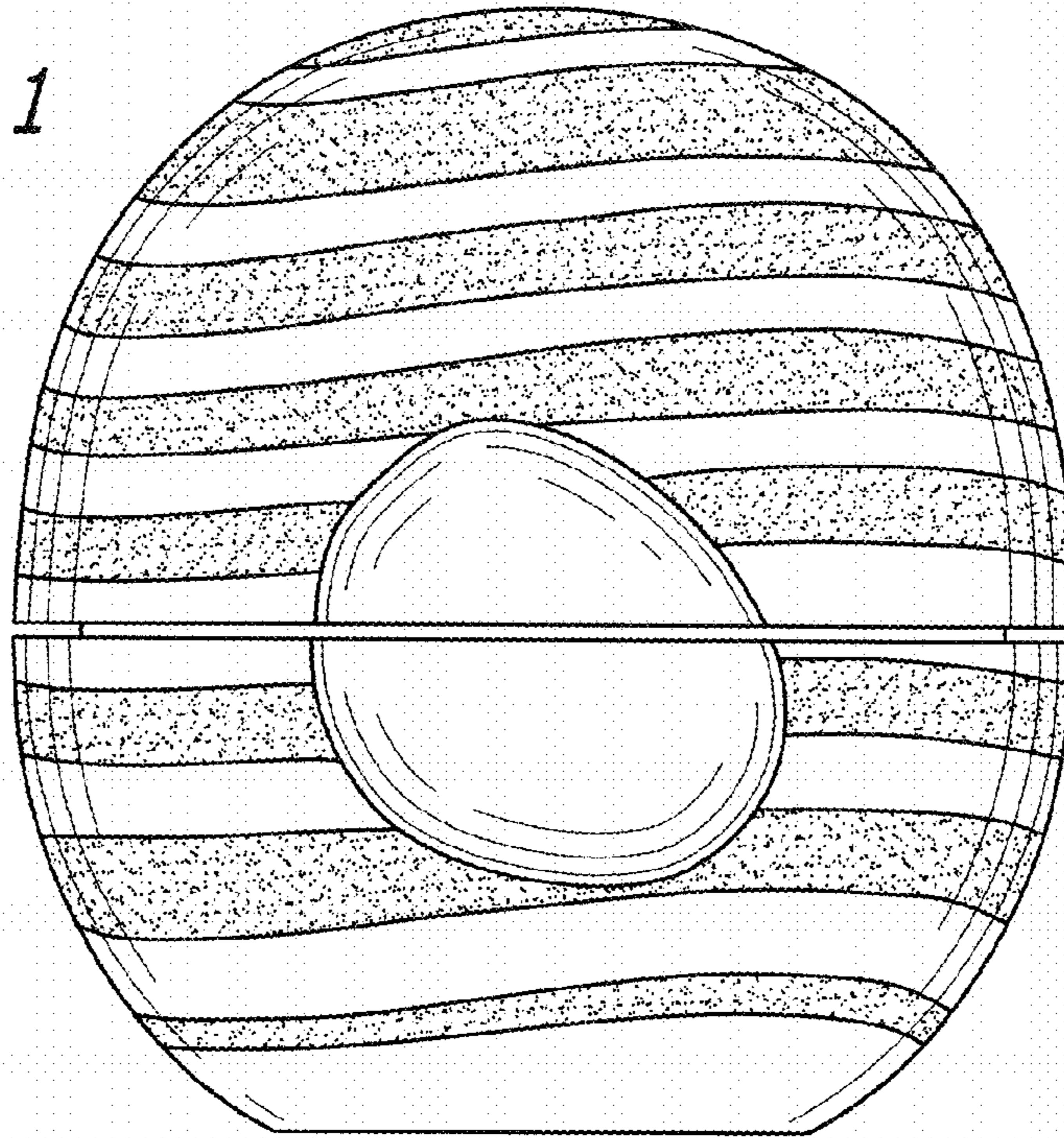
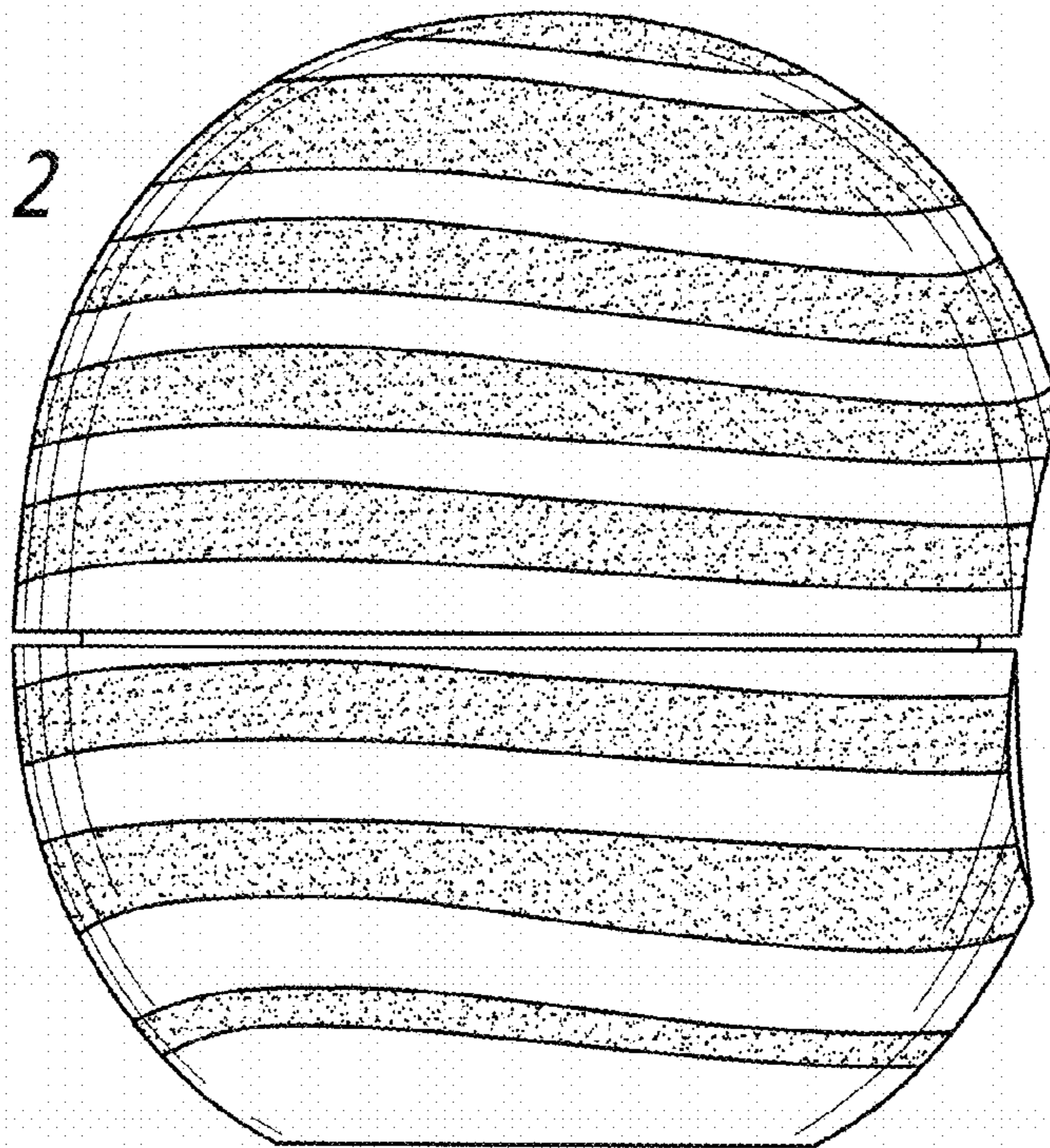
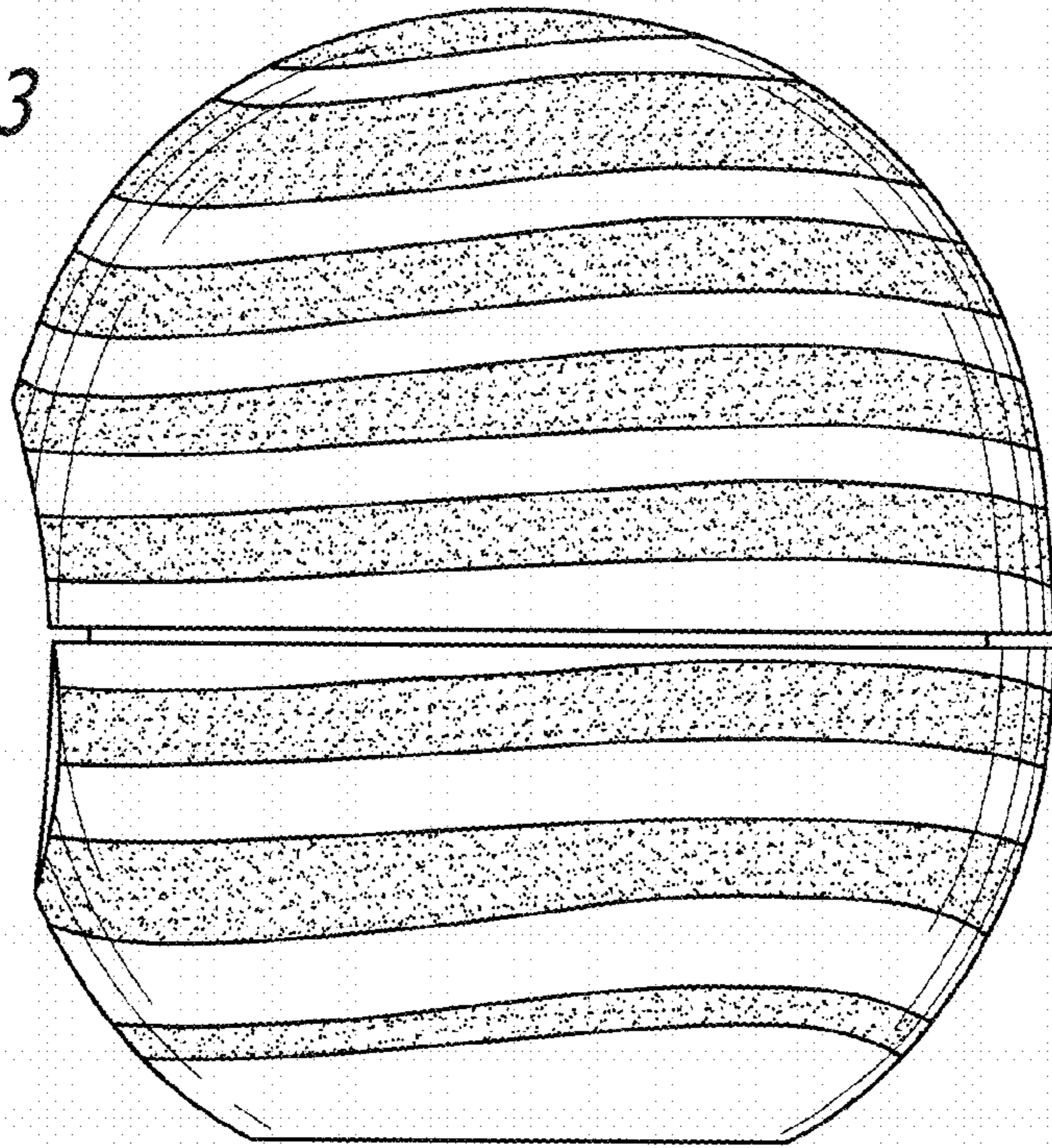

FIG. 2

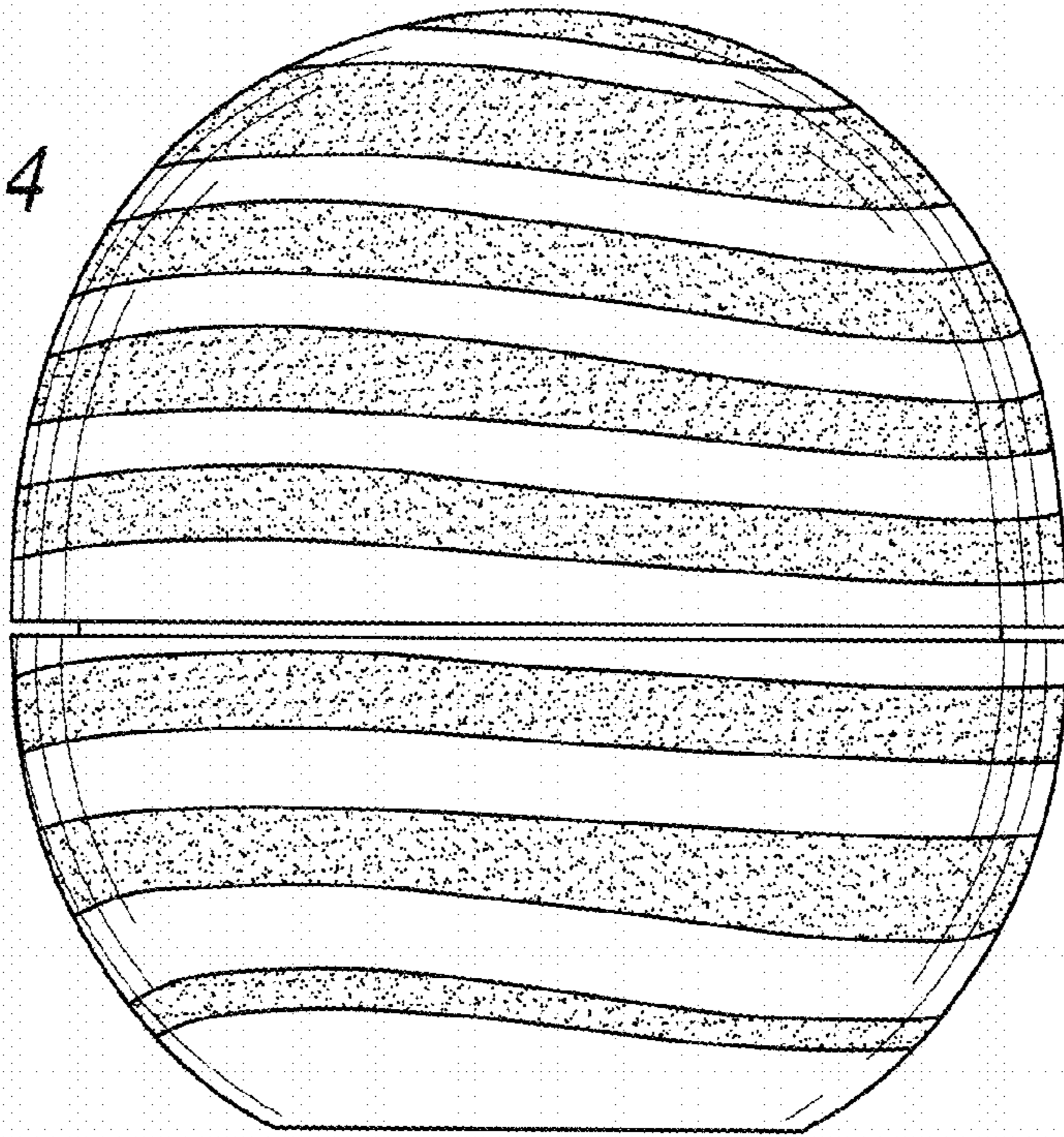



*FIG. 3*

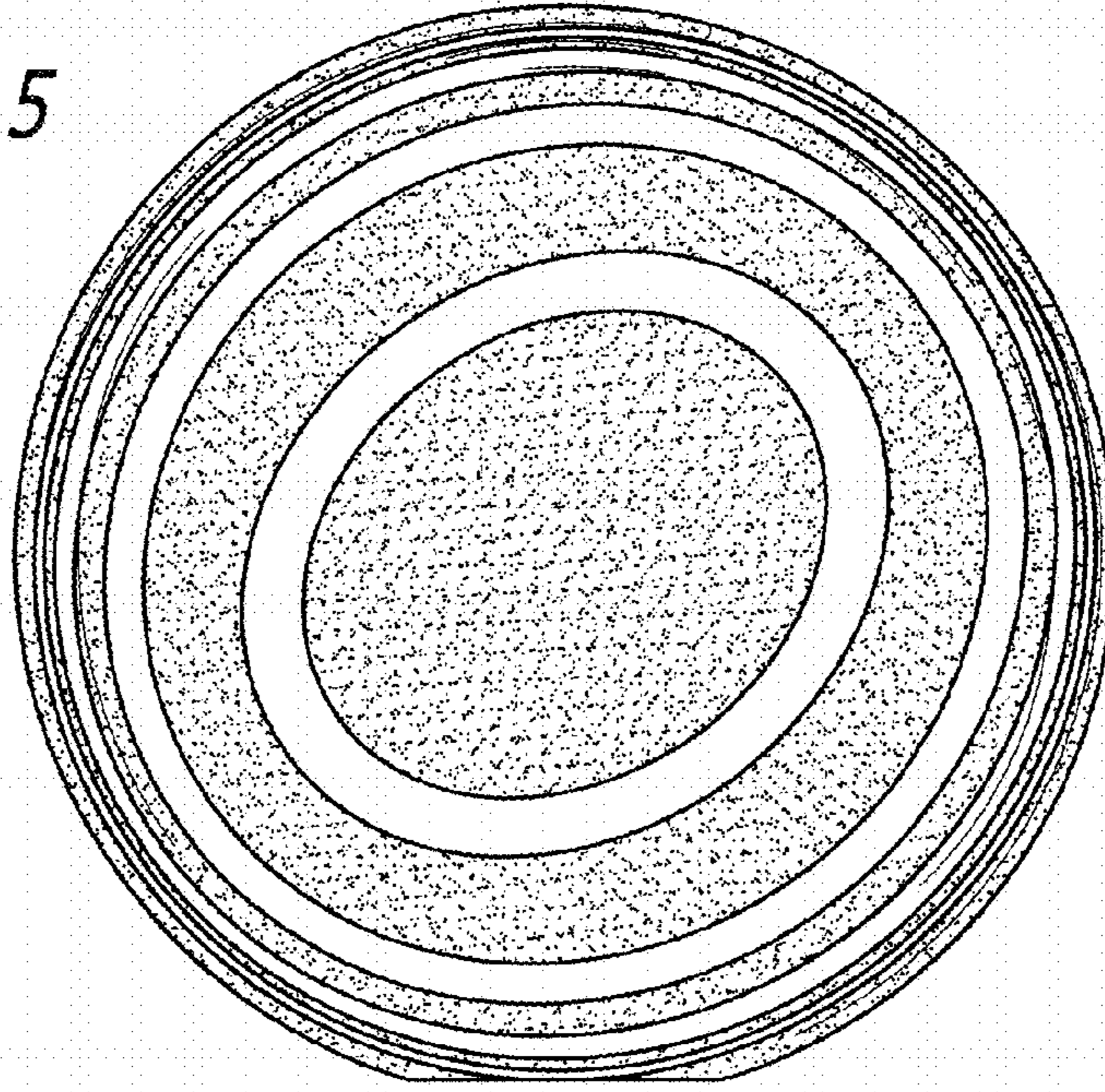

*FIG. 4*





*FIG. 5*



*FIG. 6*

