



US00D764644S

(12) **United States Design Patent** (10) **Patent No.:** **US D764,644 S**  
**Thun et al.** (45) **Date of Patent:** **\*\* Aug. 23, 2016**

(54) **TOILET**

CPC ..... A47K 13/00; A47K 13/24  
See application file for complete search history.

(71) Applicants: **XIAMEN AXENT CORPORATION LIMITED**, Xiamen, Fujian (CN);  
**AXENT SWITZERLAND AG**,  
Rapperswil-Jona (CH)

(56) **References Cited**

U.S. PATENT DOCUMENTS

D332,830 S *	1/1993	Gerlach	.....	D23/311
D557,392 S *	12/2007	Mukai	.....	D23/311
D639,401 S *	6/2011	Starck	.....	D23/295
8,296,870 B2 *	10/2012	Kannengiesser	.....	A47K 13/00 4/234
D688,359 S *	8/2013	Ogata	.....	D23/311
D704,316 S *	5/2014	Ishikawa	.....	D23/295
D732,150 S *	6/2015	Jung	.....	D23/295

(72) Inventors: **Matteo Thun**, Rapperswil-Jona (CH);  
**Antonio Rodriguez**, Rapperswil-Jona  
(CH)

(73) Assignees: **XIAMEN AXENT CORPORATION LIMITED**, Xiamen (CN); **AXENT SWITZERLAND AG**, Rapperswil-Jona  
(CH)

\* cited by examiner

*Primary Examiner* — Robert Delehanty  
(74) *Attorney, Agent, or Firm* — Rabin & Berdo, P.C.

(\*\*) Term: **15 Years**

(57) **CLAIM**

(21) Appl. No.: **29/538,790**

The ornamental design for a toilet, as shown and described.

(22) Filed: **Sep. 8, 2015**

**DESCRIPTION**

(30) **Foreign Application Priority Data**

Mar. 9, 2015 (CN) ..... 2015 3 0056225

(51) **LOC (10) Cl.** ..... **23-02**

(52) **U.S. Cl.**  
USPC ..... **D23/311**

FIG. 1 is a front view of a toilet showing our new design;  
FIG. 2 is a rear view thereof;  
FIG. 3 is a left side view thereof;  
FIG. 4 is a right side view thereof;  
FIG. 5 is a top plan view thereof; and,  
FIG. 6 is a perspective view thereof.  
The broken lines shown in the drawings are for the purpose  
of illustration and form no part of the claimed design.

(58) **Field of Classification Search**  
USPC ..... D23/311, 303, 295, 300–301

**1 Claim, 6 Drawing Sheets**

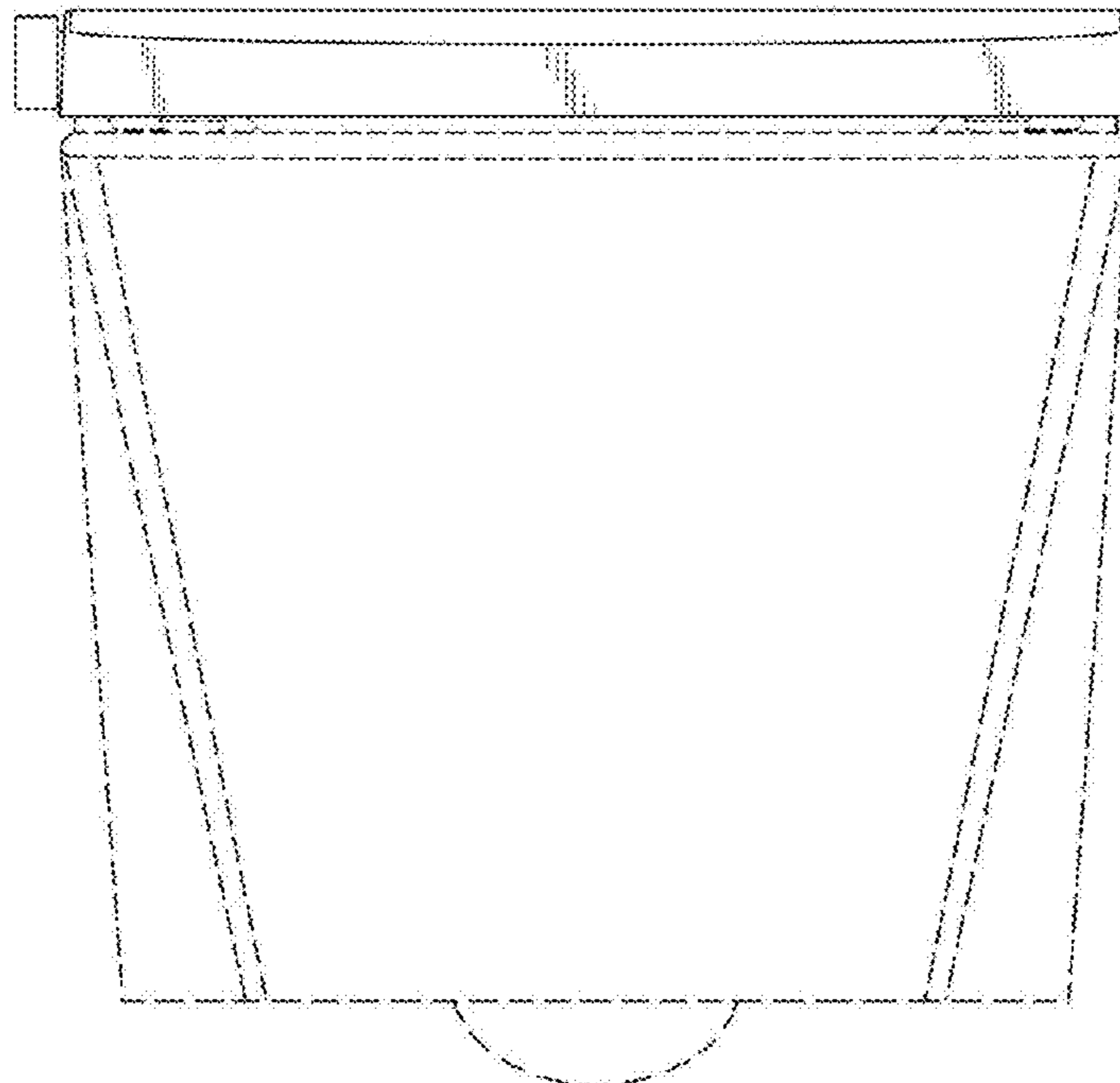

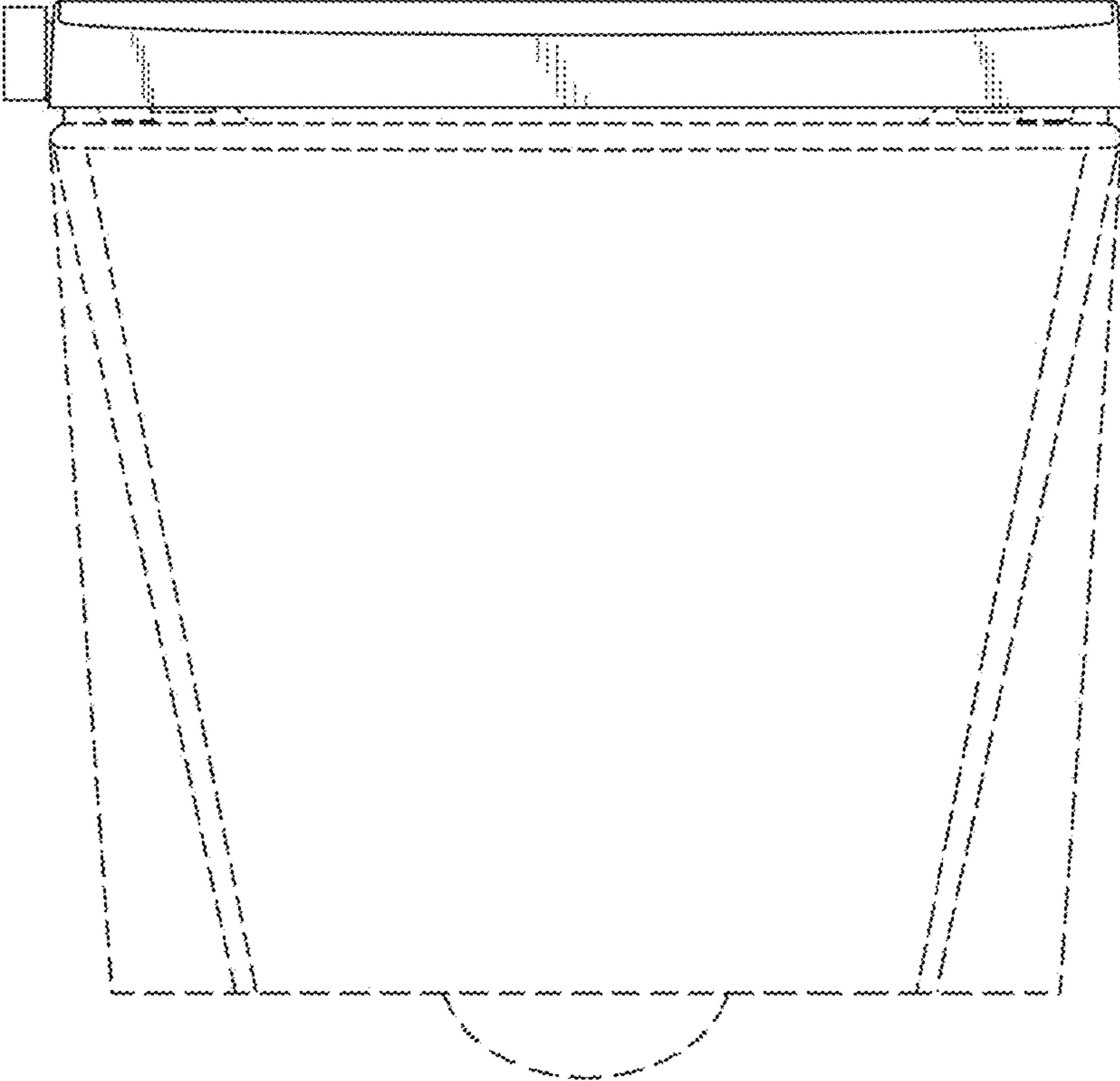

Fig. 1

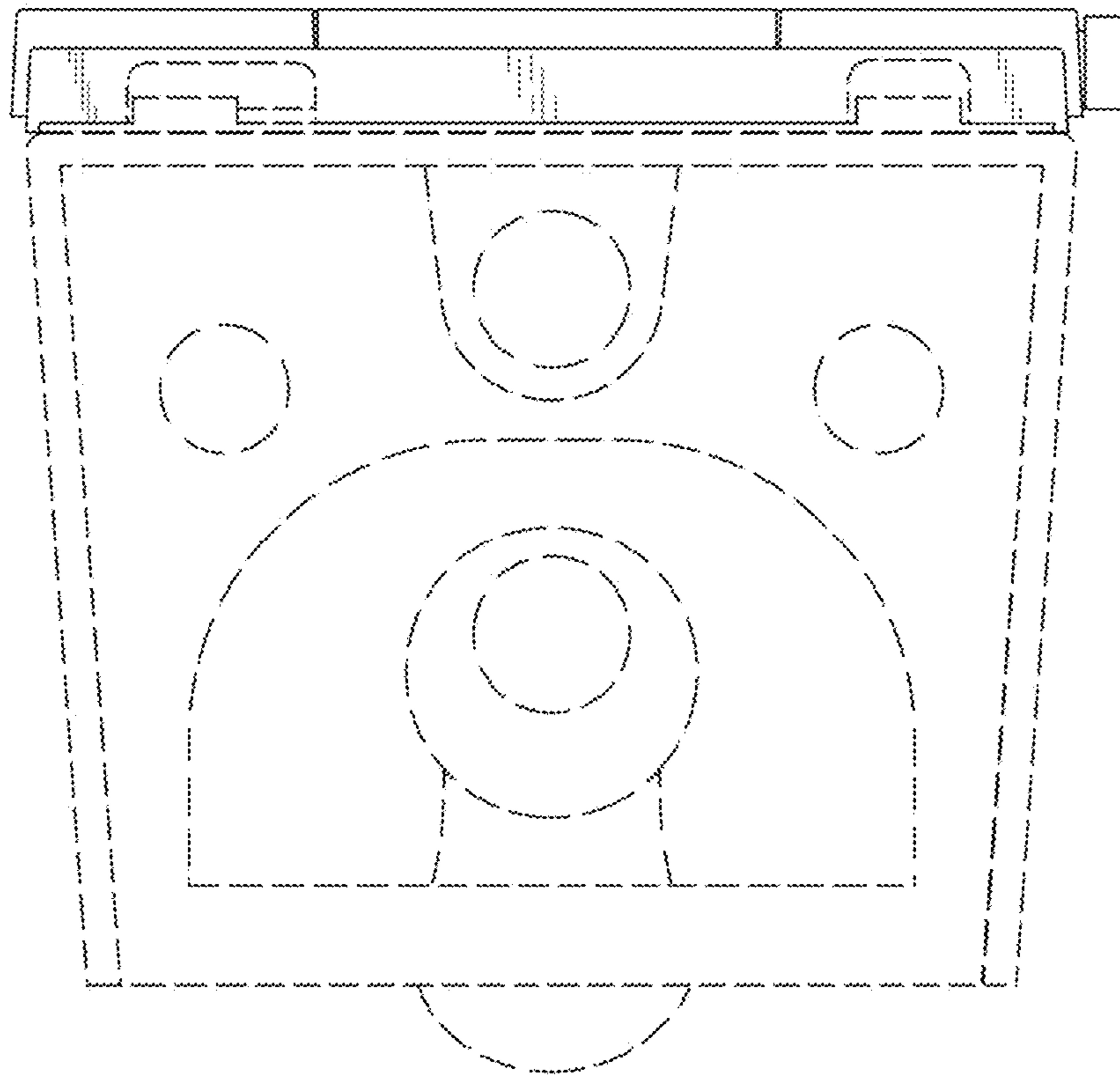

Fig. 2

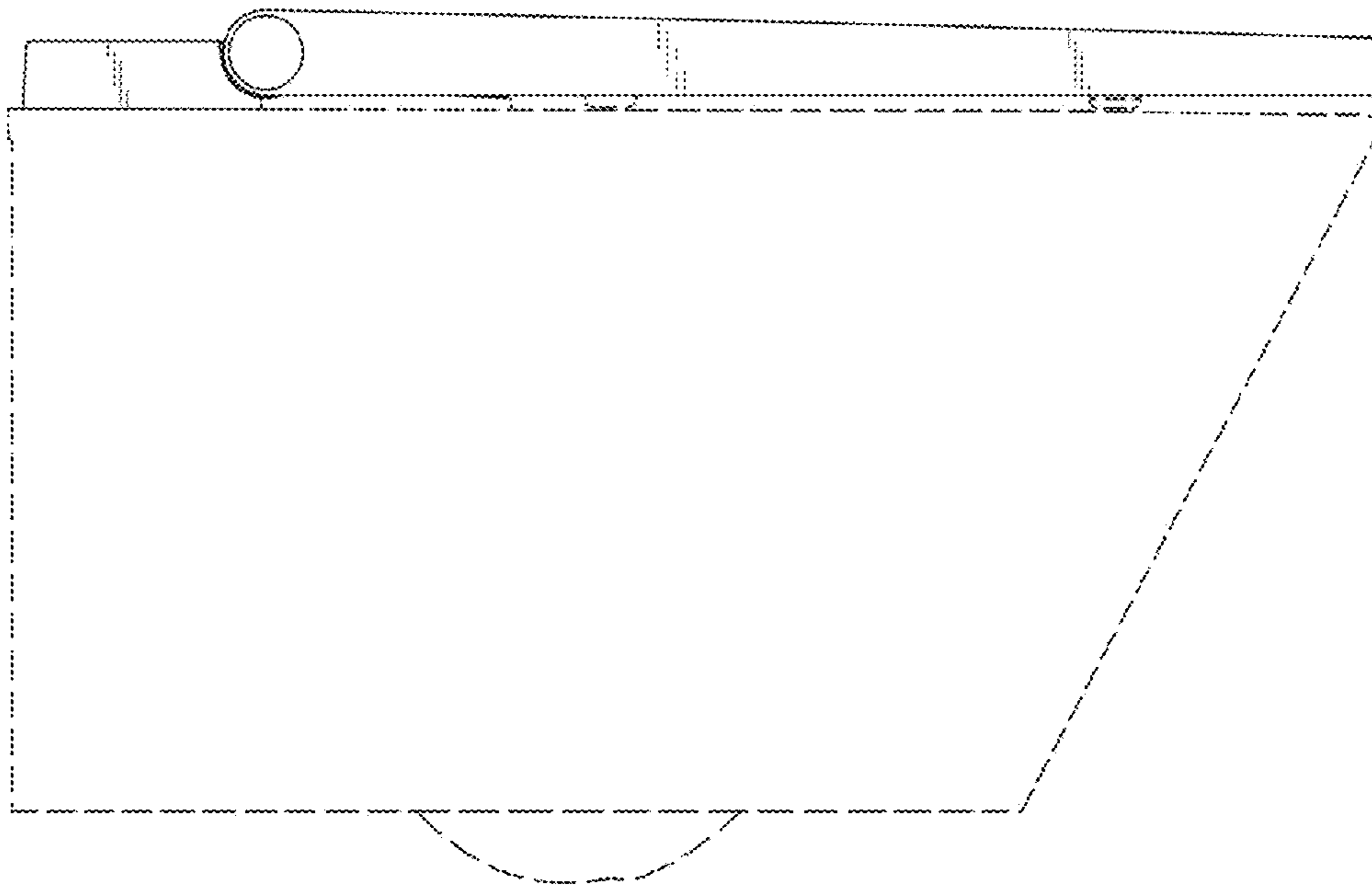

Fig. 3

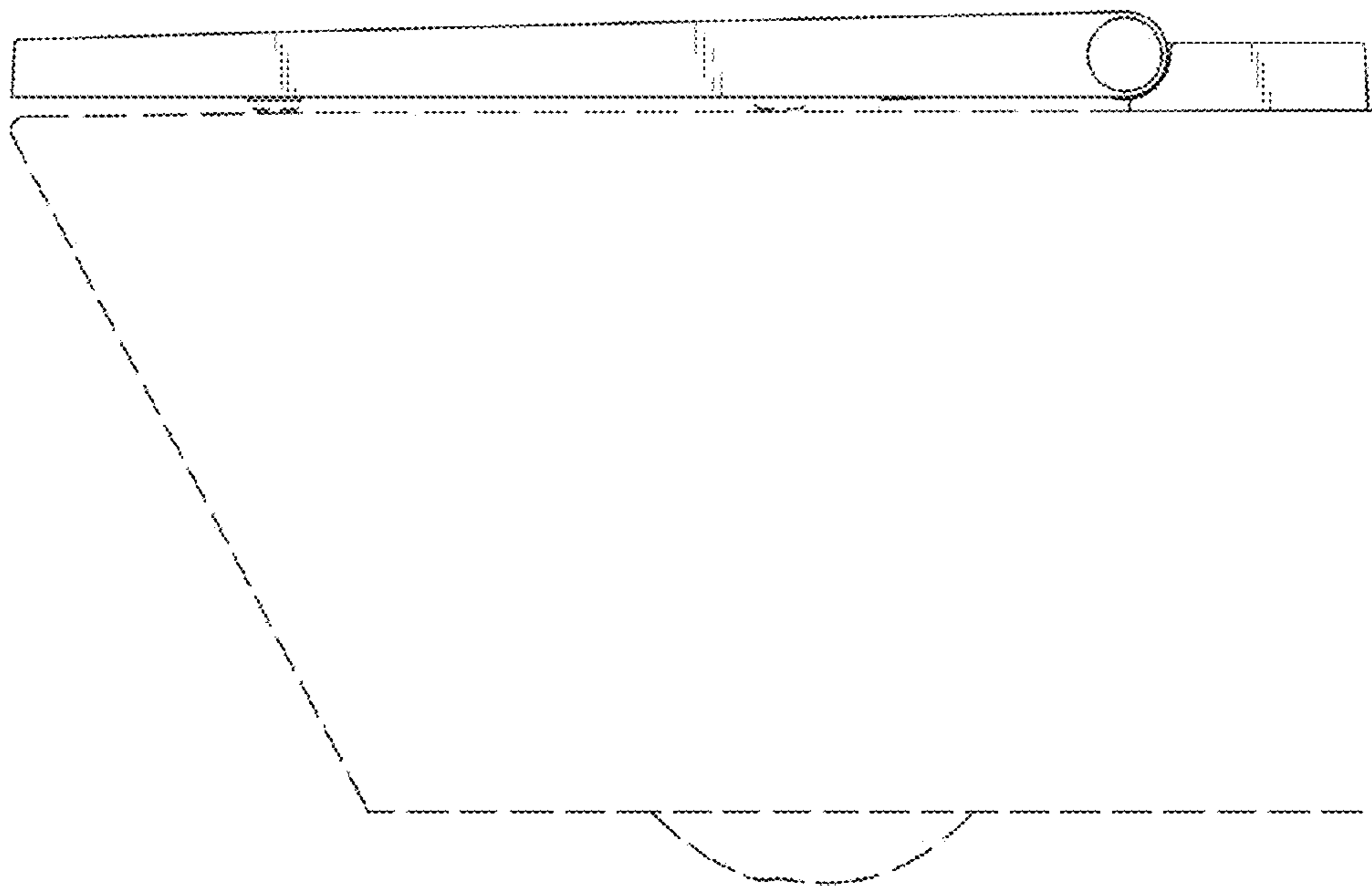

Fig. 4

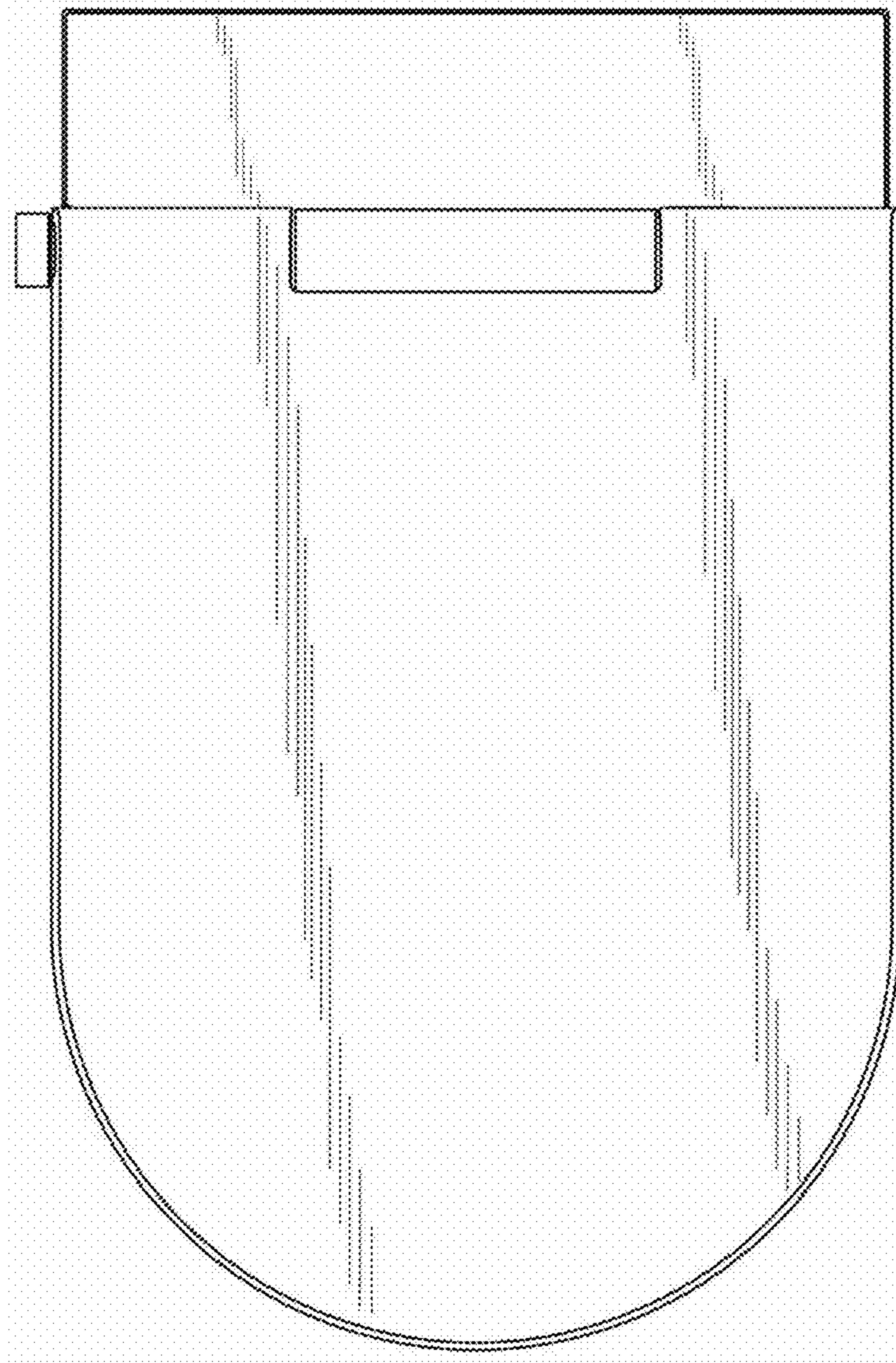

Fig. 5

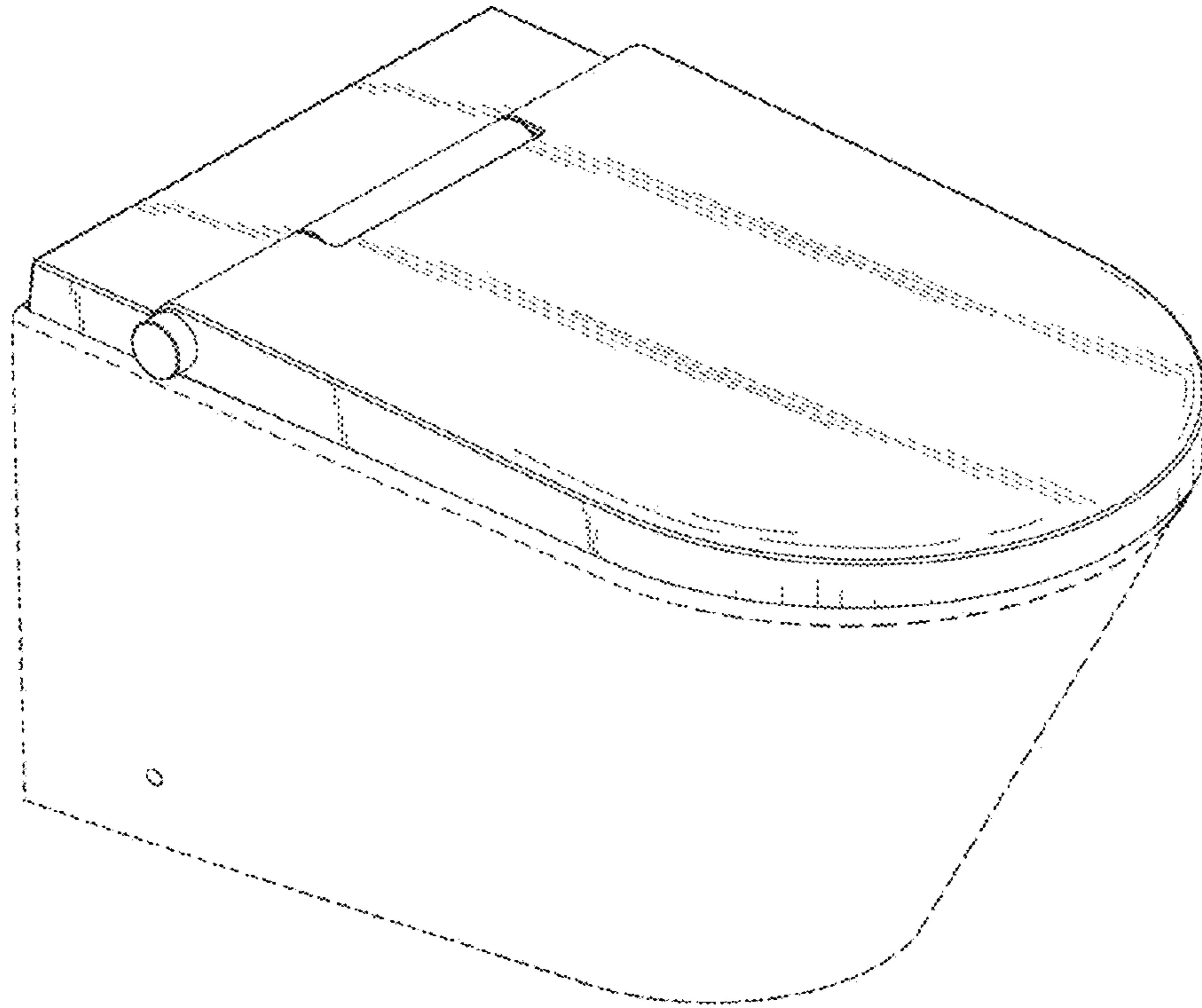

Fig. 6