

US00D764591S

(12) **United States Design Patent**  
**Kim**

(10) **Patent No.:** **US D764,591 S**

(45) **Date of Patent:** **\*\* Aug. 23, 2016**

(54) **HIGHLIGHTER**  
(71) Applicant: **DONG-A TEACHING MATERIALS CO., LTD.**, Daejeon (KR)

(72) Inventor: **Hakjae Kim**, Seoul (KR)

(\*\*) Term: **15 Years**

(21) Appl. No.: **35/500,328**

(22) Filed: **Oct. 23, 2015**

(80) **Hague Agreement Data**

Int. Filing Date: **Oct. 23, 2015**

Int. Reg. No.: **DM/088324**

Int. Reg. Date: **Oct. 23, 2015**

Int. Reg. Pub. Date: **Dec. 4, 2015**

(51) **LOC (10) Cl.** ..... **19-06**

(52) **U.S. Cl.**  
USPC ..... **D19/163; D19/917**

(58) **Field of Classification Search**  
USPC ..... D14/411; D19/115-204  
CPC ..... B43K 5/00; B43K 7/00; B43K 7/10;  
B43K 7/12; B43K 8/04; B43K 19/00; B43K  
19/02; B43K 19/14  
See application file for complete search history.

(56) **References Cited**

**U.S. PATENT DOCUMENTS**

D65,683 S \* 9/1924 Benjamin ..... D19/164  
D81,742 S \* 8/1930 Back ..... D19/168  
D84,394 S \* 6/1931 Bienenstein ..... D19/168  
D87,611 S \* 8/1932 Whitehouse ..... D19/164

D89,815 S \* 5/1933 Tefft ..... D19/163  
D92,362 S \* 5/1934 Neuhoff ..... D19/163  
2,783,711 A \* 3/1957 Hart ..... B41K 1/003  
100/229 R  
D203,234 S \* 12/1965 Momma ..... D19/167  
D206,917 S \* 2/1967 Jensen ..... D19/168  
D241,434 S \* 9/1976 Shank ..... D19/168  
D331,259 S \* 11/1992 Rousseau ..... D19/168  
D353,044 S \* 12/1994 Riley ..... D3/228  
D437,888 S \* 2/2001 Briggl ..... D19/169  
D501,253 S \* 1/2005 Bainton ..... D19/164  
D575,818 S \* 8/2008 Zhang ..... D19/169  
D593,605 S \* 6/2009 Yu ..... D19/169  
D636,022 S \* 4/2011 Kim ..... D19/168  
D650,857 S \* 12/2011 Lira-Nunez ..... D19/168  
D681,115 S \* 4/2013 Lee ..... D19/168  
D695,828 S \* 12/2013 Kim ..... D19/168  
D726,824 S \* 4/2015 Lee ..... D19/164

\* cited by examiner

*Primary Examiner* — Elizabeth Albert

(57) **CLAIM**

The ornamental design for a highlighter, as shown and described.

**DESCRIPTION**

1. Highlighter  
1.1 : Back  
1.2 : Bottom  
1.3 : Front  
1.4 : Left  
1.5 : Right  
1.6 : Perspective  
1.7 : Top  
A highlighter used by removing the cap.

**1 Claim, 7 Drawing Sheets**

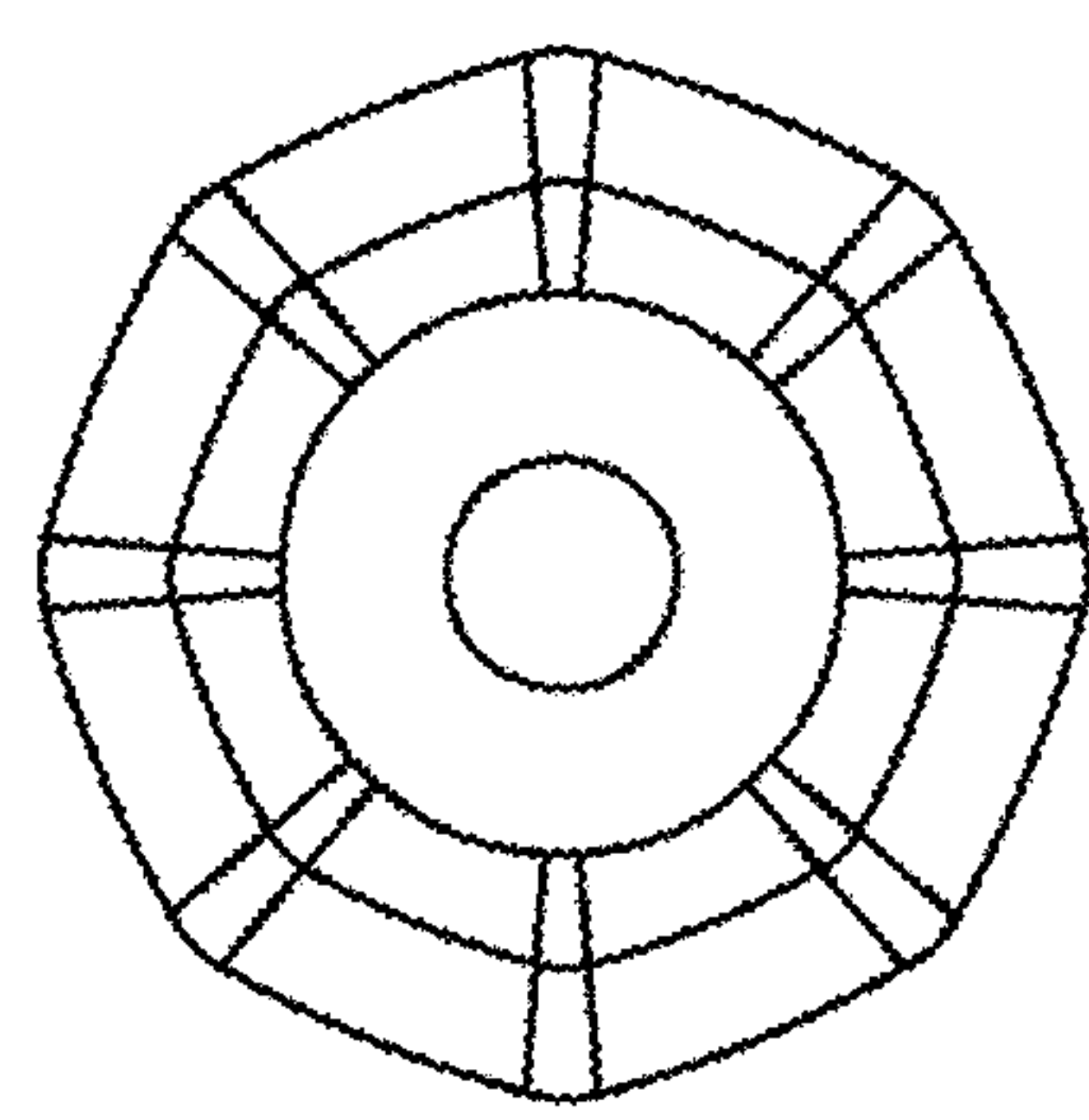
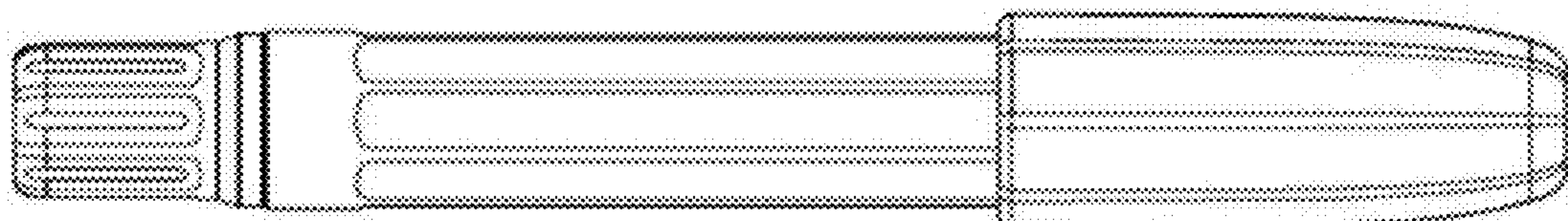

1.1

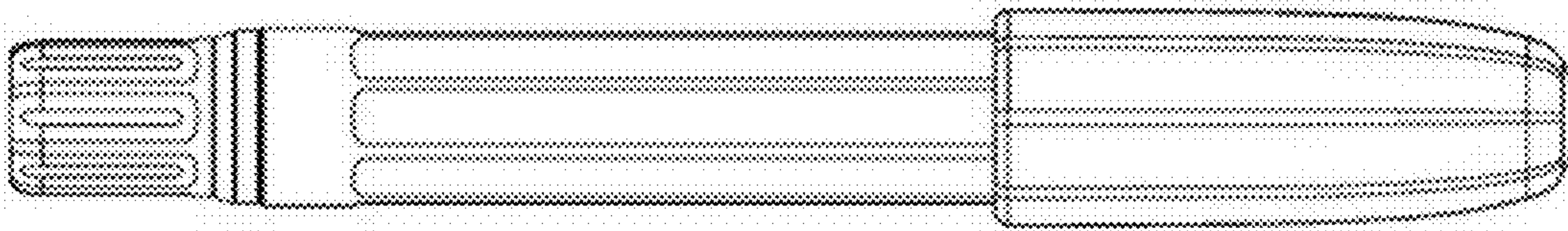

1.2

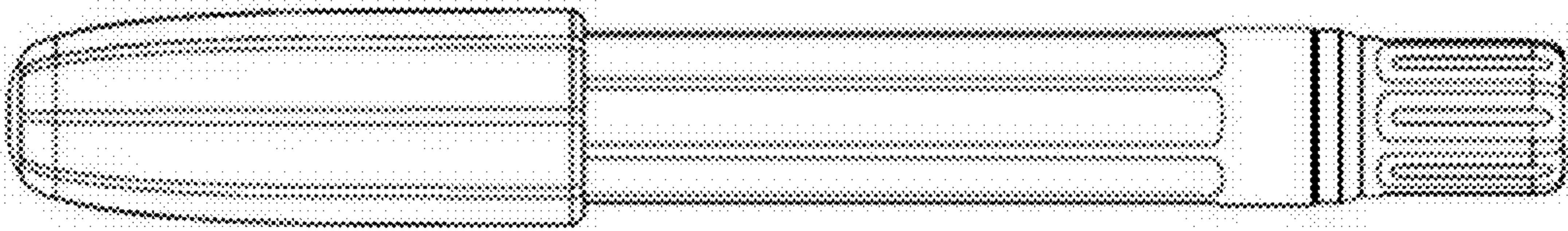

1.3

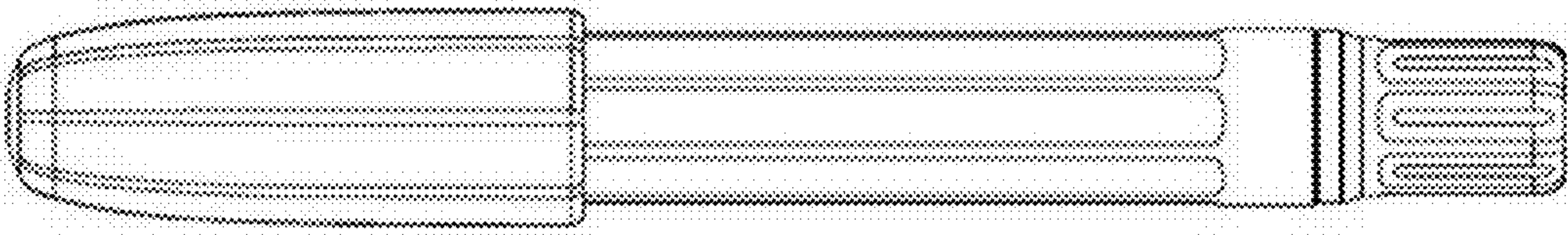

1.4

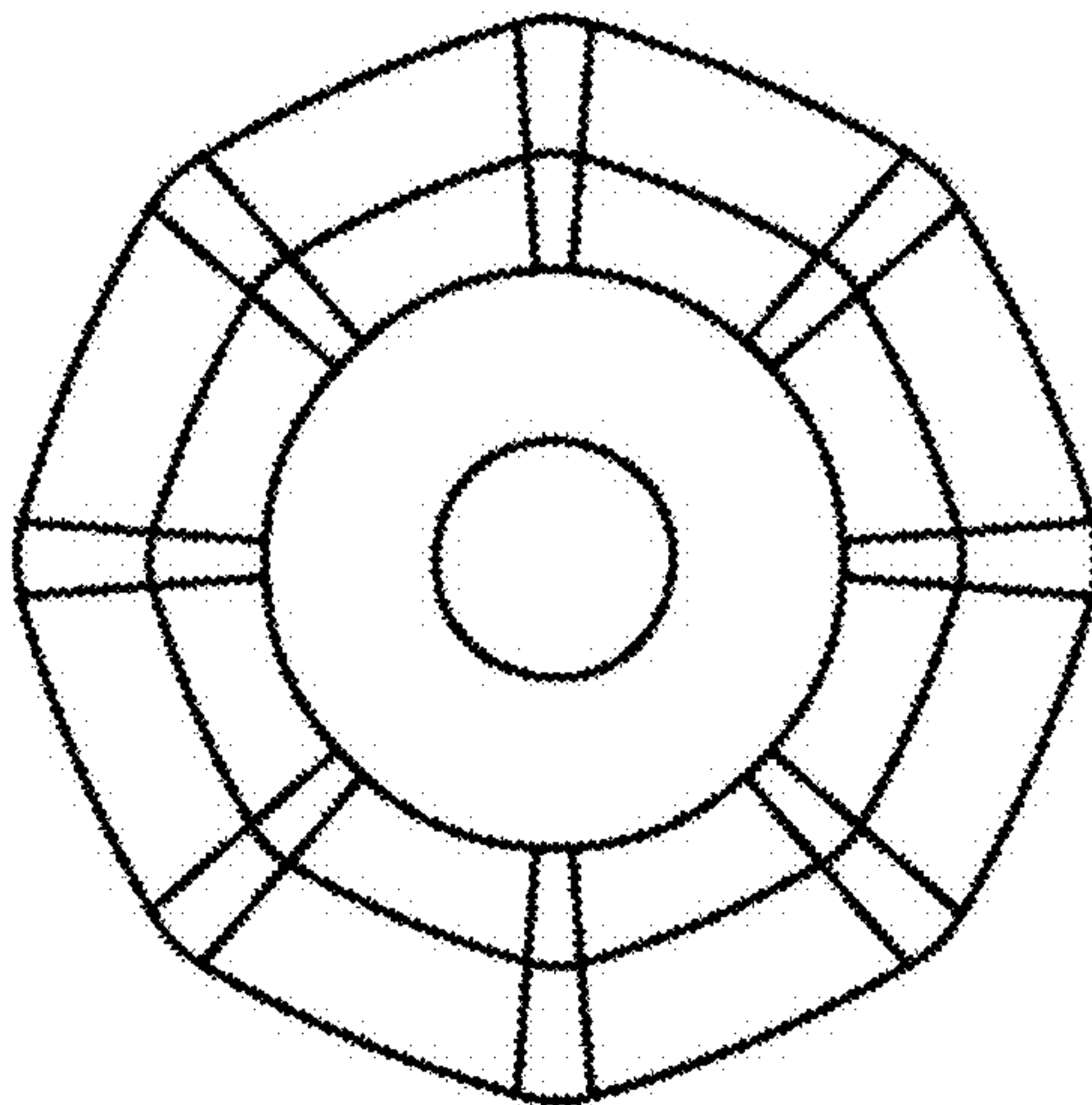

1.5

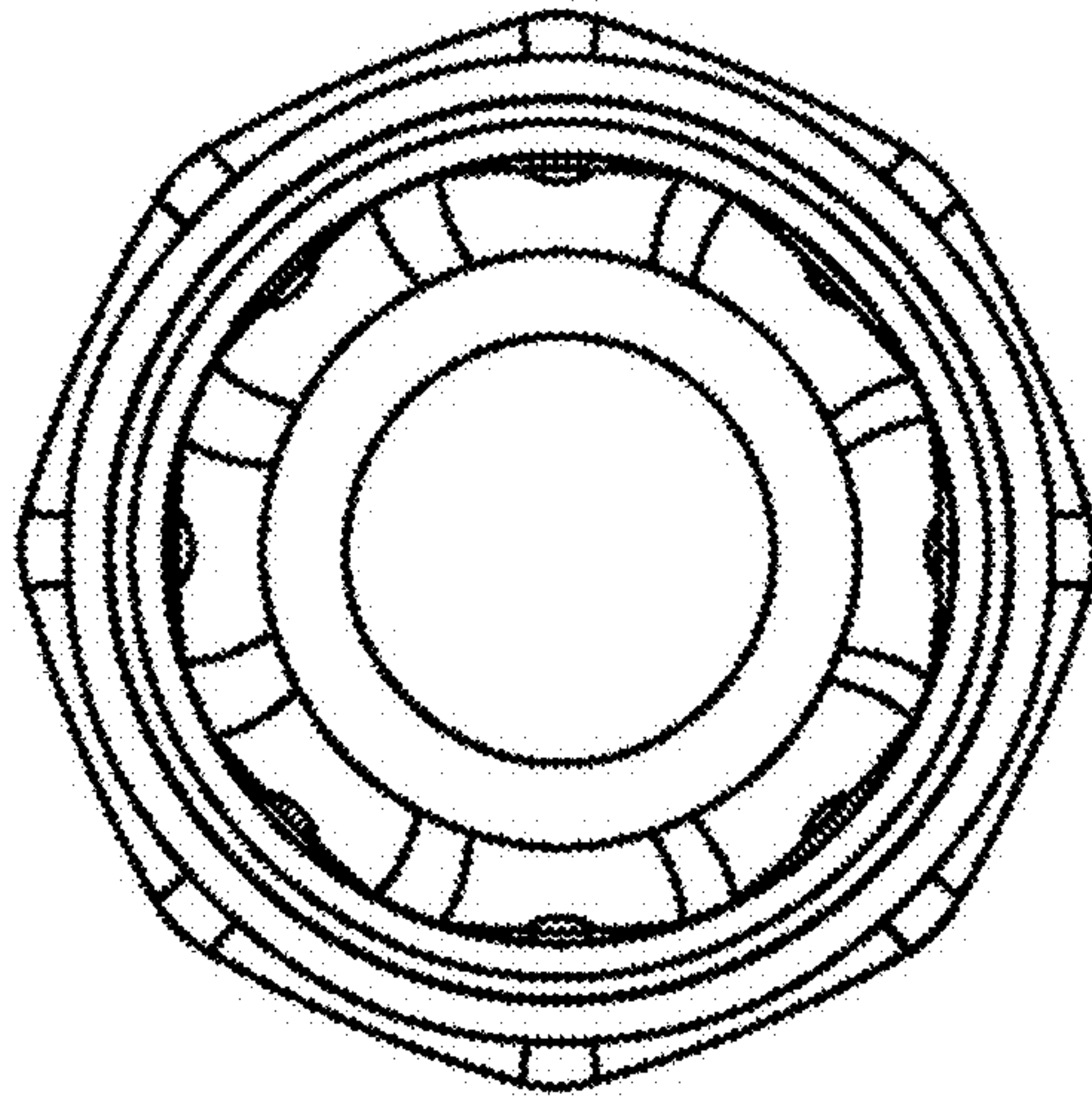



1.6

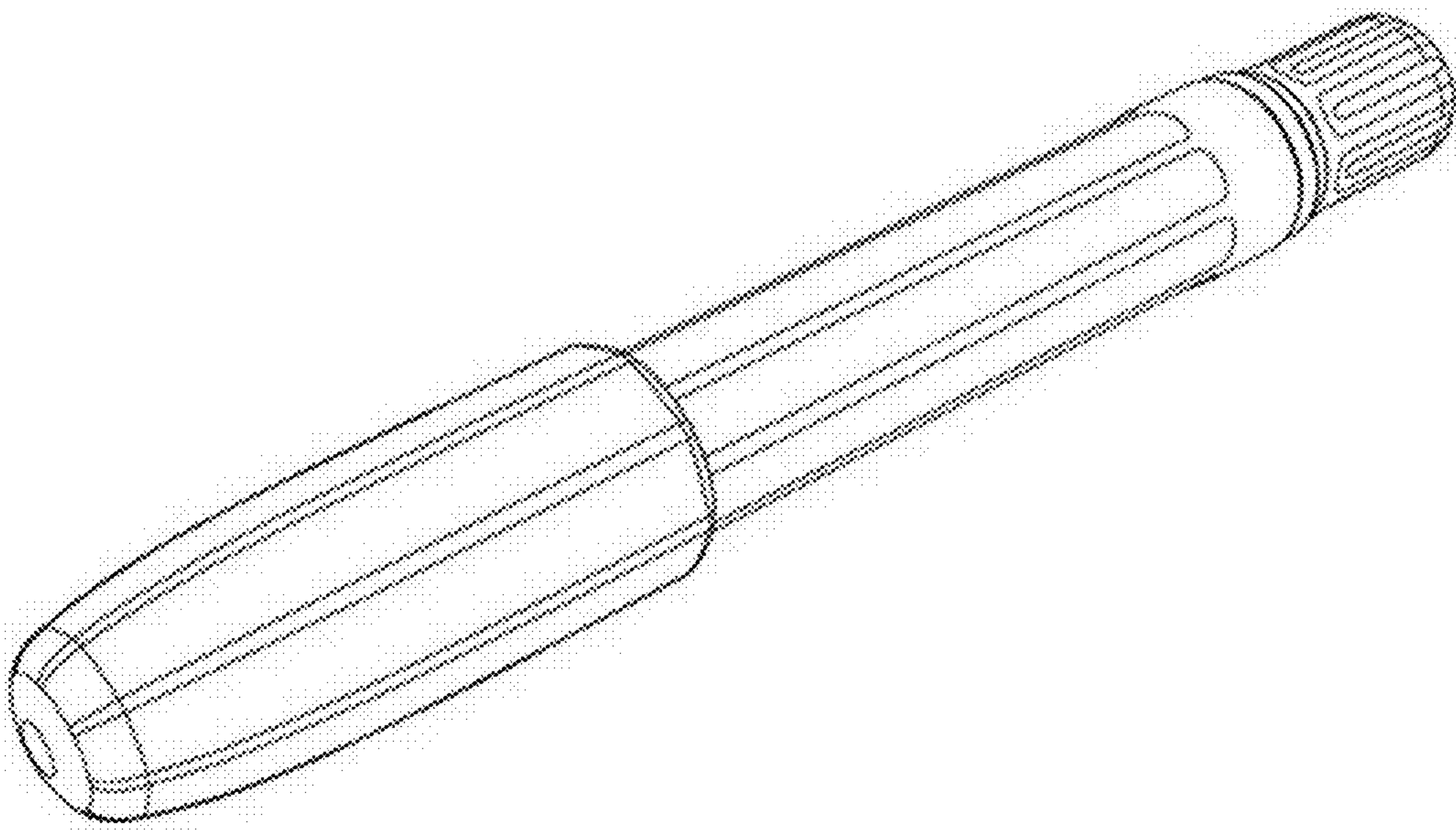

1.7

